

## APPENDIX B

# SIZING OF VENTING SYSTEMS SERVING APPLIANCES EQUIPPED WITH DRAFT HOODS, CATEGORY I APPLIANCES, AND APPLIANCES LISTED FOR USE WITH TYPE B VENTS

(This appendix is informative and is not part of the code. This appendix is an excerpt from the 2012 *International Fuel Gas Code*, coordinated with the section numbering of the *International Residential Code*.)

### EXAMPLES USING SINGLE APPLIANCE VENTING TABLES

#### Example 1: Single draft-hood-equipped appliance.

An installer has a 120,000 British thermal unit (Btu) per hour input *appliance* with a 5-inch-diameter draft hood outlet that needs to be vented into a 10-foot-high Type B vent system. What size vent should be used assuming (a) a 5-foot lateral single-wall metal vent connector is used with two 90-degree elbows, or (b) a 5-foot lateral single-wall metal vent connector is used with three 90-degree elbows in the vent system?

#### Solution:

Table 504.2(2) should be used to solve this problem, because single-wall metal vent connectors are being used with a Type B vent.

- (a) Read down the first column in Table 504.2(2) until the row associated with a 10-foot height and 5-foot lateral is found. Read across this row until a vent capacity greater than 120,000 Btu per hour is located in the

shaded columns *labeled* "NAT Max" for draft-hood-equipped appliances. In this case, a 5-inch-diameter vent has a capacity of 122,000 Btu per hour and may be used for this application.

- (b) If three 90-degree elbows are used in the vent system, then the maximum vent capacity listed in the tables must be reduced by 10 percent (see Section 504.2.3 for single *appliance* vents). This implies that the 5-inch-diameter vent has an adjusted capacity of only 110,000 Btu per hour. In this case, the vent system must be increased to 6 inches in diameter (see calculations below).

$$122,000 (0.90) = 110,000 \text{ for 5-inch vent}$$

From Table 504.2(2), Select 6-inch vent

$$186,000 (0.90) = 167,000; \text{ This is greater than the required } 120,000. \text{ Therefore, use a 6-inch vent and connector where three elbows are used.}$$

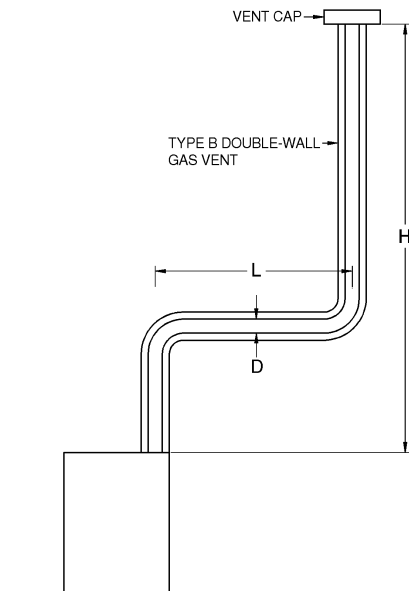

For SI: 1 foot = 304.8 mm, 1 British thermal unit per hour = 0.2931 W.  
Table 504.2(1) is used when sizing Type B double-wall gas vent connected directly to the appliance.

**Note:** The appliance may be either Category I draft hood equipped or fan-assisted type.

**FIGURE B-1**  
**TYPE B DOUBLE-WALL VENT SYSTEM SERVING A SINGLE APPLIANCE WITH A TYPE B DOUBLE-WALL VENT**

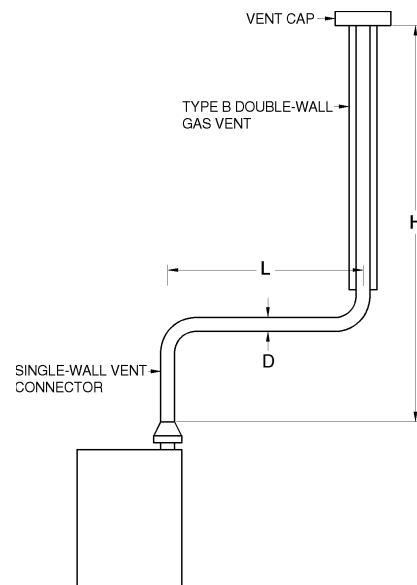

For SI: 1 foot = 304.8 mm, 1 British thermal unit per hour = 0.2931 W.  
Table 504.2(2) is used when sizing a single-wall metal vent connector attached to a Type B double-wall gas vent.

**Note:** The appliance may be either Category I draft hood equipped or fan-assisted type.

**FIGURE B-2**  
**TYPE B DOUBLE-WALL VENT SYSTEM SERVING A SINGLE APPLIANCE WITH A SINGLE-WALL METAL VENT CONNECTOR**

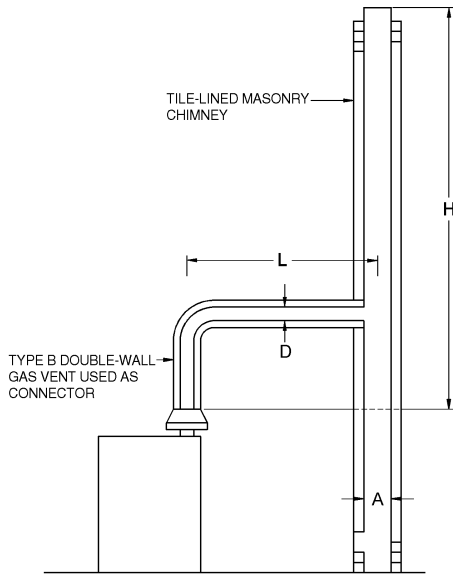
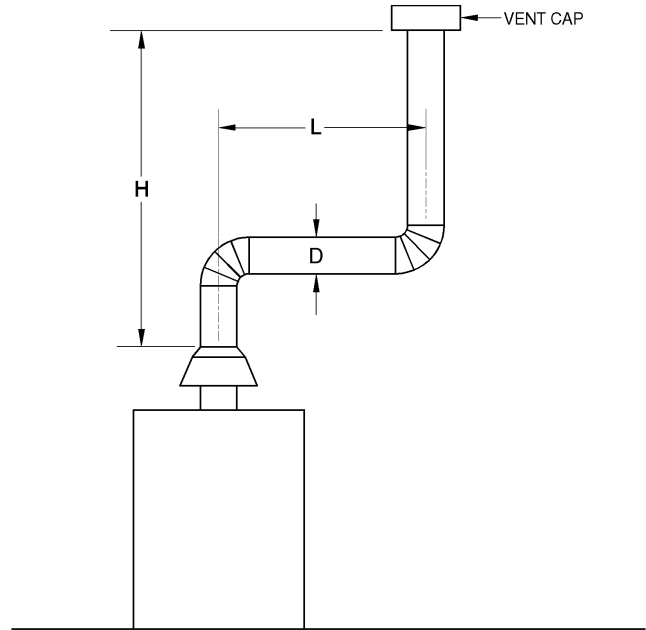

Table 504.2(3) is used when sizing a Type B double-wall gas vent connector attached to a tile-lined masonry chimney.

**Note:** "A" is the equivalent cross-sectional area of the tile liner.

**Note:** The appliance may be either Category I draft hood equipped or fan-assisted type.

**FIGURE B-3**  
**VENT SYSTEM SERVING A SINGLE APPLIANCE WITH A MASONRY CHIMNEY OF TYPE B DOUBLE-WALL VENT CONNECTOR**



Asbestos cement Type B or single-wall metal vent serving a single draft-hood-equipped appliance [see Table 504.2(5)].

**FIGURE B-5**  
**ASBESTOS CEMENT TYPE B OR SINGLE-WALL METAL VENT SYSTEM SERVING A SINGLE DRAFT-HOOD-EQUIPPED APPLIANCE**

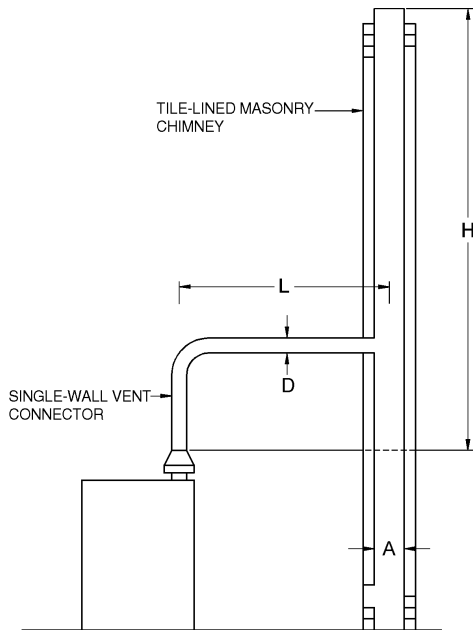

Table 504.2(4) is used when sizing a single-wall vent connector attached to a tile-lined masonry chimney.

**Note:** "A" is the equivalent cross-sectional area of the tile liner.

**Note:** The appliance may be either Category I draft hood equipped or fan-assisted type.

**FIGURE B-4**  
**VENT SYSTEM SERVING A SINGLE APPLIANCE USING A MASONRY CHIMNEY AND A SINGLE-WALL METAL VENT CONNECTOR**

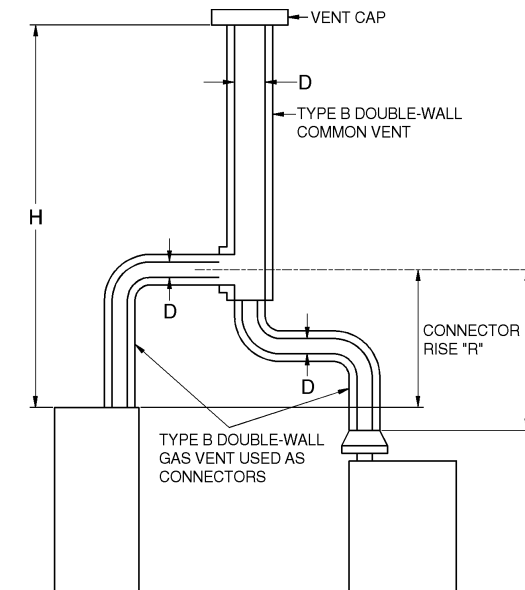

Table 504.3(1) is used when sizing Type B double-wall vent connectors attached to a Type B double-wall common vent.

**Note:** Each appliance may be either Category I draft hood equipped or fan-assisted type.

**FIGURE B-6**  
**VENT SYSTEM SERVING TWO OR MORE APPLIANCES WITH TYPE B DOUBLE-WALL VENT AND TYPE B DOUBLE-WALL VENT CONNECTOR**

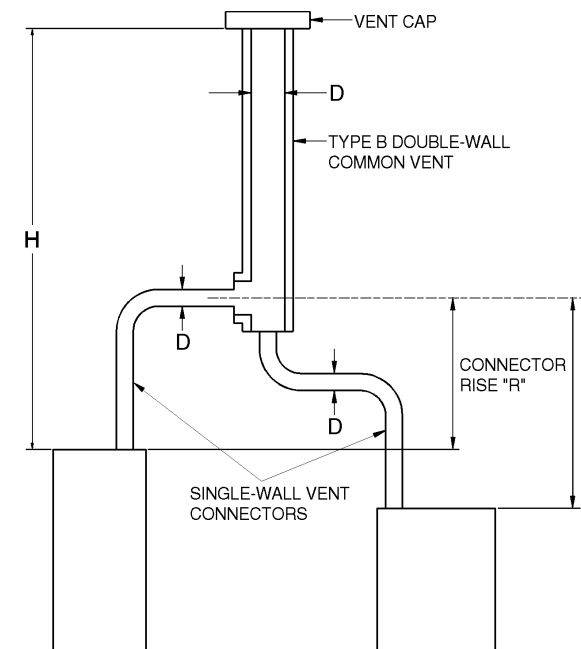

Table 504.3(2) is used when sizing single-wall vent connectors attached to a Type B double-wall common vent.

**Note:** Each appliance may be either Category I draft hood equipped or fan-assisted type.

**FIGURE B-7**  
**VENT SYSTEM SERVING TWO OR MORE APPLIANCES**  
**WITH TYPE B DOUBLE-WALL VENT AND**  
**SINGLE-WALL METAL VENT CONNECTORS**

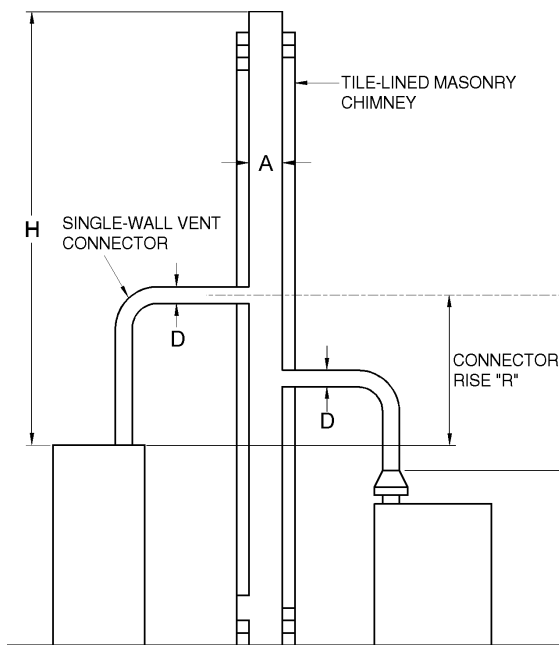

Table 504.3(4) is used when sizing single-wall metal vent connectors attached to a tile-lined masonry chimney.

**Note:** "A" is the equivalent cross-sectional area of the tile liner.

**Note:** Each appliance may be either Category I draft hood equipped or fan-assisted type.

**FIGURE B-9**  
**MASONRY CHIMNEY SERVING TWO OR MORE APPLIANCES**  
**WITH SINGLE-WALL METAL VENT CONNECTORS**

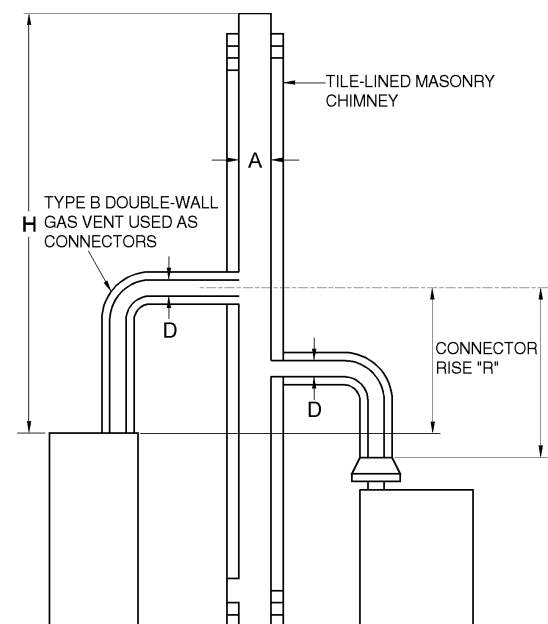
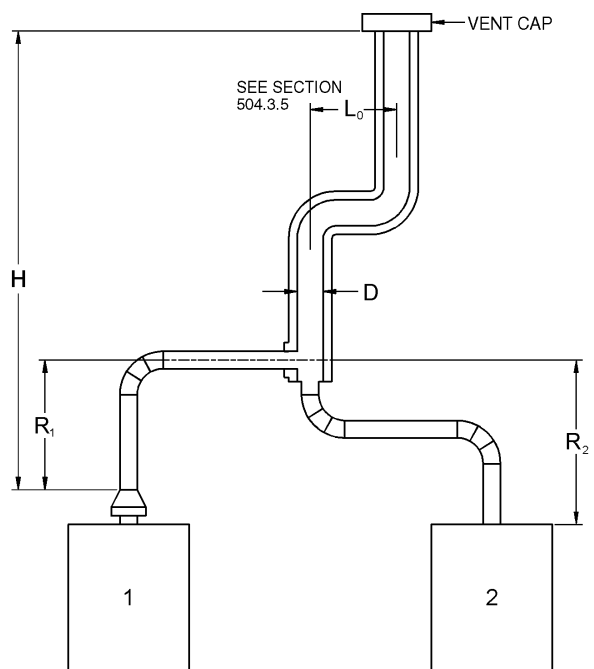

Table 504.3(3) is used when sizing Type B double-wall vent connectors attached to a tile-lined masonry chimney.

**Note:** "A" is the equivalent cross-sectional area of the tile liner.

**Note:** Each appliance may be either Category I draft hood equipped or fan-assisted type.

**FIGURE B-8**  
**MASONRY CHIMNEY SERVING TWO OR MORE APPLIANCES**  
**WITH TYPE B DOUBLE-WALL VENT CONNECTOR**



Asbestos cement Type B or single-wall metal pipe vent serving two or more draft-hood-equipped appliances [see Table 504.3(5)].

**FIGURE B-10**  
**ASBESTOS CEMENT TYPE B OR SINGLE-WALL**  
**METAL VENT SYSTEM SERVING TWO OR MORE**  
**DRAFT-HOOD-EQUIPPED APPLIANCES**

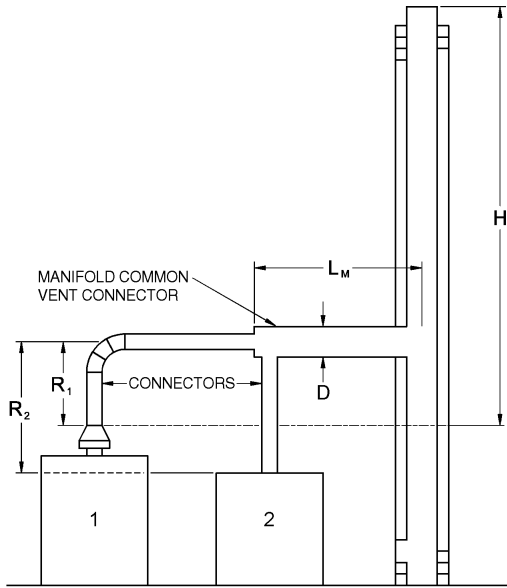

Example: Manifolded Common Vent Connector  $L_M$  shall be no greater than 18 times the common vent connector manifold inside diameter; i.e., a 4-inch (102 mm) inside diameter common vent connector manifold shall not exceed 72 inches (1829 mm) in length (see Section 504.3.4).

**Note:** This is an illustration of a typical manifolded vent connector. Different appliance, vent connector, or common vent types are possible. Consult Section 502.3.

**FIGURE B-11**  
USE OF MANIFOLD COMMON VENT CONNECTOR

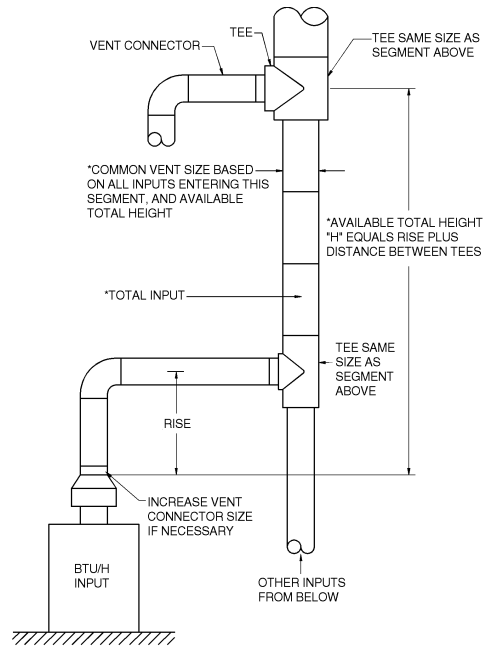

Vent connector size depends on:

- Input
- Rise
- Available total height "H"
- Table 504.3(1) connectors

Common vent size depends on:

- Combined inputs
- Available total height "H"
- Table 504.3(1) common vent connectors

**FIGURE B-13**  
MULTISTORY GAS VENT DESIGN PROCEDURE FOR EACH SEGMENT OF SYSTEM

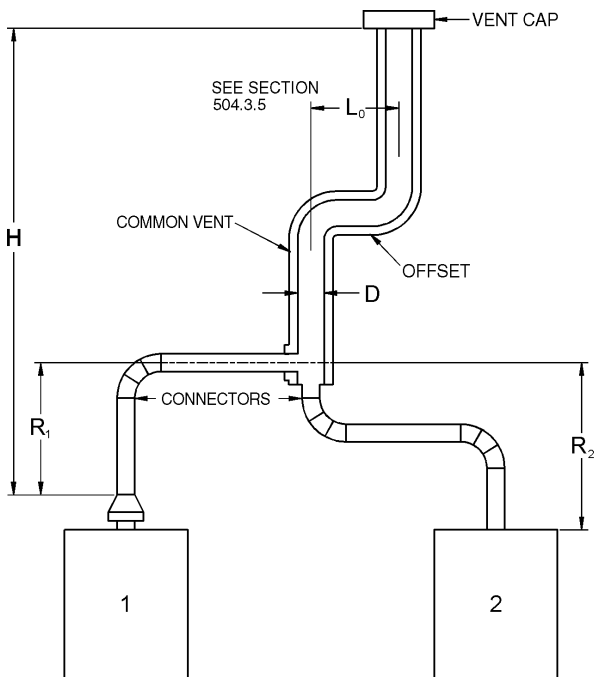

Example: Offset Common Vent

**Note:** This is an illustration of a typical offset vent. Different appliance, vent connector, or vent types are possible. Consult Sections 504.2 and 504.3.

**FIGURE B-12**  
USE OF OFFSET COMMON VENT

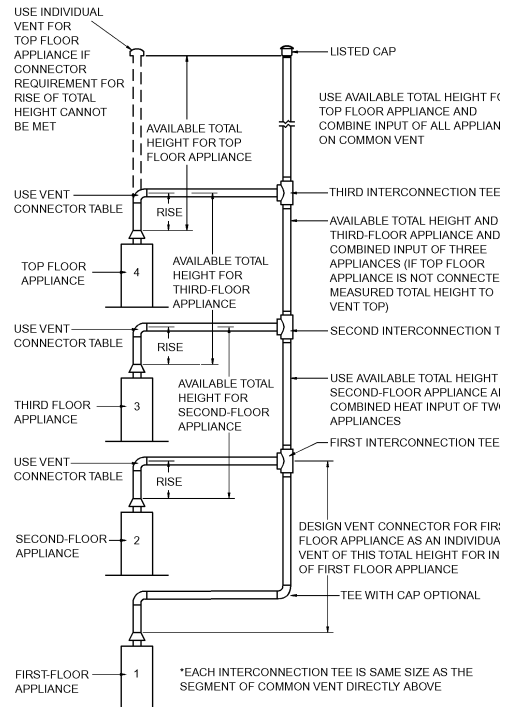

Principles of design of multistory vents using vent connector and common vent design tables (see Sections 504.3.11 through 504.3.17).

**FIGURE B-14**  
MULTISTORY VENT SYSTEMS

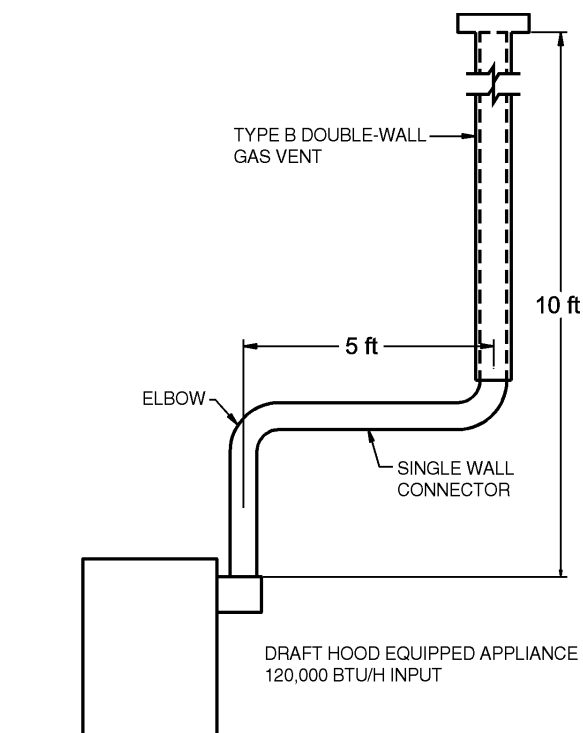

For SI: 1 foot = 304.8 mm, 1 British thermal unit per hour = 0.2931 W.

**FIGURE B-15 (EXAMPLE 1)**  
**SINGLE DRAFT-HOOD-EQUIPPED APPLIANCE**

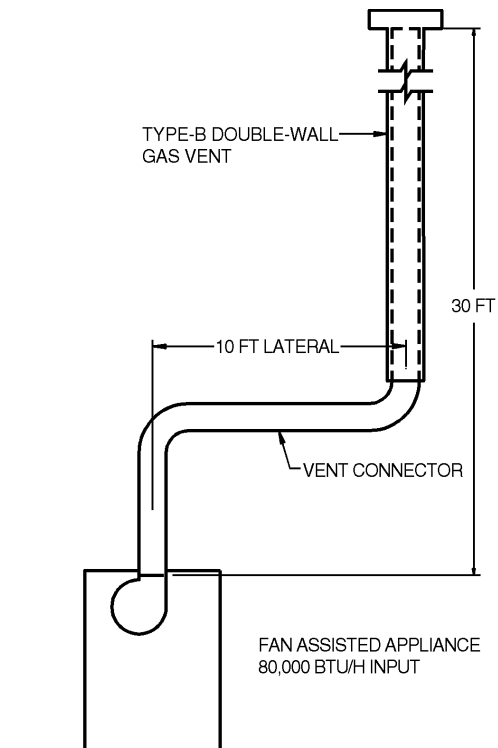

For SI: 1 foot = 304.8 mm, 1 British thermal unit per hour = 0.2931 W.

**FIGURE B-16 (EXAMPLE 2)**  
**SINGLE FAN-ASSISTED APPLIANCE**

### Example 2: Single fan-assisted appliance.

An installer has an 80,000 Btu per hour input fan-assisted *appliance* that must be installed using 10 feet of lateral connector attached to a 30-foot-high Type B vent. Two 90-degree elbows are needed for the installation. Can a single-wall metal vent connector be used for this application?

#### Solution:

Table 504.2(2) refers to the use of single-wall metal vent connectors with Type B vent. In the first column find the row associated with a 30-foot height and a 10-foot lateral. Read across this row, looking at the FAN Min and FAN Max columns, to find that a 3-inch-diameter single-wall metal vent connector is not recommended. Moving to the next larger size single wall connector (4 inches), note that a 4-inch-diameter single-wall metal connector has a recommended minimum vent capacity of 91,000 Btu per hour and a recommended maximum vent capacity of 144,000 Btu per hour. The 80,000 Btu per hour fan-assisted *appliance* is outside this range, so the conclusion is that a single-wall metal vent connector cannot be used to vent this *appliance* using 10 feet of lateral for the connector.

However, if the 80,000 Btu per hour input *appliance* could be moved to within 5 feet of the vertical vent, then a 4-inch single-wall metal connector could be used to vent the *appliance*. Table 504.2(2) shows the acceptable range of vent capacities for a 4-inch vent with 5 feet of lateral to be between 72,000 Btu per hour and 157,000 Btu per hour.

If the *appliance* cannot be moved closer to the vertical vent, then Type B vent could be used as the connector material. In this case, Table 504.2(1) shows that for a 30-foot-high vent with 10 feet of lateral, the acceptable range of vent capacities for a 4-inch-diameter vent attached to a fan-assisted *appliance* is between 37,000 Btu per hour and 150,000 Btu per hour.

### Example 3: Interpolating between table values.

An installer has an 80,000 Btu per hour input *appliance* with a 4-inch-diameter draft hood outlet that needs to be vented into a 12-foot-high Type B vent. The vent connector has a 5-foot lateral length and is also Type B. Can this *appliance* be vented using a 4-inch-diameter vent?

#### Solution:

Table 504.2(1) is used in the case of an all Type B vent system. However, since there is no entry in Table 504.2(1) for a height of 12 feet, interpolation must be used. Read down the 4-inch diameter NAT Max column to the row associated with 10-foot height and 5-foot lateral to find the capacity value of 77,000 Btu per hour. Read further down to the 15-foot height, 5-foot lateral row to find the capacity value of 87,000 Btu per hour. The difference between the 15-foot height capacity value and the 10-foot height capacity value is 10,000 Btu per hour. The capacity for a vent system with a 12-foot height is equal to the capacity for a 10-foot height plus  $\frac{2}{5}$  of the difference between the 10-foot and 15-foot height values, or  $77,000 + \frac{2}{5}(10,000) = 81,000$  Btu per hour. Therefore, a 4-inch-diameter vent may be used in the installation.

**EXAMPLES USING COMMON VENTING TABLES**

**Example 4: Common venting two draft-hood-equipped appliances.**

A 35,000 Btu per hour water heater is to be common vented with a 150,000 Btu per hour furnace using a common vent with a total height of 30 feet. The connector rise is 2 feet for the water heater with a horizontal length of 4 feet. The connector rise for the furnace is 3 feet with a horizontal length of 8 feet. Assume single-wall metal connectors will be used with Type B vent. What size connectors and combined vent should be used in this installation?

**Solution:**

Table 504.3(2) should be used to size single-wall metal vent connectors attached to Type B vertical vents. In the vent connector capacity portion of Table 504.3(2), find the row associated with a 30-foot vent height. For a 2-foot rise on the vent connector for the water heater, read the shaded columns for draft-hood-equipped appliances to find that a 3-inch-diameter vent connector has a capacity of 37,000 Btu per hour. Therefore, a 3-inch single-wall metal vent connector may be used with the water heater. For a draft-hood-equipped furnace with a 3-foot rise, read across the appropriate row to find that a 5-inch-diameter vent connector has a maximum capacity of 120,000 Btu per hour (which is too small for the furnace) and a 6-inch-diameter vent connector has a maximum vent capacity of 172,000 Btu per hour. Therefore, a 6-inch-diameter vent connector should be used with the 150,000 Btu per hour furnace. Since both vent connector horizontal lengths are less than the maximum lengths listed in Section 504.3.2, the table values may be used without adjustments.

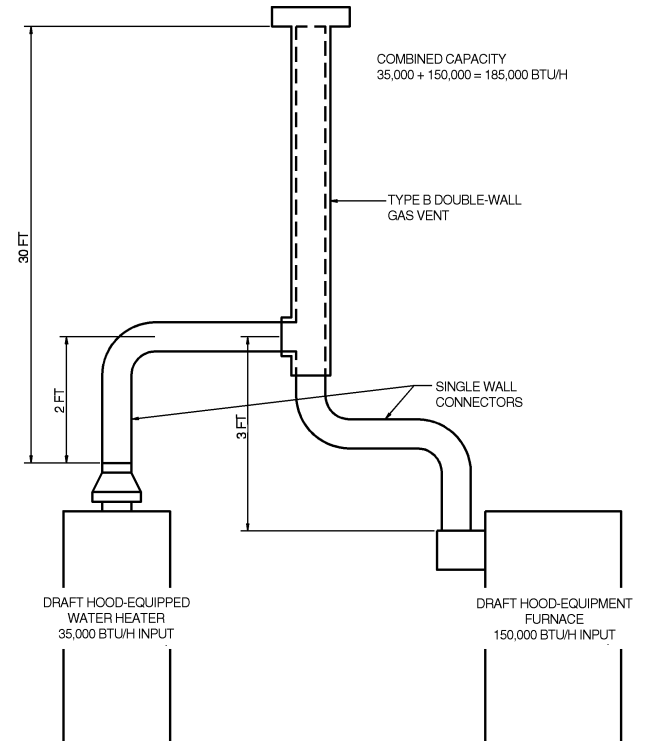

FIGURE B-17 (EXAMPLE 4)

In the common vent capacity portion of Table 504.3(2), find the row associated with a 30-foot vent height and read over to the NAT + NAT portion of the 6-inch-diameter column to find a maximum combined capacity of 257,000 Btu per hour. Since the two appliances total only 185,000 Btu per hour, a 6-inch common vent may be used.

**Example 5a: Common venting a draft-hood-equipped water heater with a fan-assisted furnace into a Type B vent.**

In this case, a 35,000 Btu per hour input draft-hood-equipped water heater with a 4-inch-diameter draft hood outlet, 2 feet of connector rise, and 4 feet of horizontal length is to be common vented with a 100,000 Btu per hour fan-assisted furnace with a 4-inch-diameter flue collar, 3 feet of connector rise, and 6 feet of horizontal length. The common vent consists of a 30-foot height of Type B vent. What are the recommended vent diameters for each connector and the common vent? The installer would like to use a single-wall metal vent connector.

**Solution:** [Table 504.3(2)].

Water Heater Vent Connector Diameter. Since the water heater vent connector horizontal length of 4 feet is less than the maximum value listed in Section 504.3.2, the venting table values may be used without adjustments. Using the Vent Connector Capacity portion of Table 504.3(2), read down the Total Vent Height (*H*) column to 30 feet and read across the 2-foot Connector Rise (*R*) row to the first Btu per hour rating in the NAT Max column that is equal to or greater than the water heater input rating. The table shows that a 3-inch vent connector has a maximum input rating of 37,000

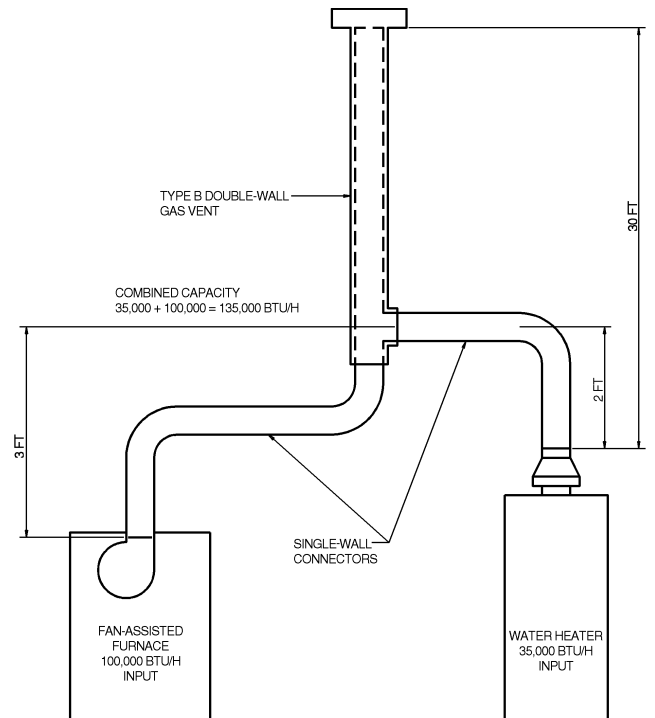

FIGURE B-18 (EXAMPLE 5A)  
COMMON VENTING A DRAFT HOOD WITH A FAN-ASSISTED

Btu per hour. Although this is greater than the water heater input rating, a 3-inch vent connector is prohibited by Section 504.3.21. A 4-inch vent connector has a maximum input rating of 67,000 Btu per hour and is equal to the draft hood *outlet* diameter. A 4-inch vent connector is selected. Since the water heater is equipped with a draft hood, there are no minimum input rating restrictions.

**Furnace Vent Connector Diameter.** Using the Vent Connector Capacity portion of Table 504.3(2), read down the Total Vent Height (*H*) column to 30 feet and across the 3-foot Connector Rise (*R*) row. Since the furnace has a fan-assisted combustion system, find the first FAN Max column with a Btu per hour rating greater than the furnace input rating. The 4-inch vent connector has a maximum input rating of 119,000 Btu per hour and a minimum input rating of 85,000 Btu per hour. The 100,000 Btu per hour furnace in this example falls within this range, so a 4-inch connector is adequate. Since the furnace vent connector horizontal length of 6 feet does not exceed the maximum value listed in Section 504.3.2, the venting table values may be used without adjustment. If the furnace had an input rating of 80,000 Btu per hour, then a Type B vent connector [see Table 504.3(1)] would be needed in order to meet the minimum capacity limit.

**Common Vent Diameter.** The total input to the common vent is 135,000 Btu per hour. Using the Common Vent Capacity portion of Table 504.3(2), read down the Total Vent Height (*H*) column to 30 feet and across this row to find the smallest vent diameter in the FAN + NAT column that has a Btu per hour rating equal to or greater than 135,000 Btu per hour. The 4-inch common vent has a capacity of 132,000 Btu per hour and the 5-inch common vent has a capacity of 202,000 Btu per hour. Therefore, the 5-inch common vent should be used in this example.

**Summary.** In this example, the installer may use a 4-inch-diameter, single-wall metal vent connector for the water heater and a 4-inch-diameter, single-wall metal vent connector for the furnace. The common vent should be a 5-inch-diameter Type B vent.

#### **Example 5b: Common venting into a masonry chimney.**

In this case, the water heater and fan-assisted furnace of Example 5a are to be common vented into a clay tile-lined masonry chimney with a 30-foot height. The chimney is not exposed to the outdoors below the roof line. The internal dimensions of the clay tile liner are nominally 8 inches by 12 inches. Assuming the same vent connector heights, laterals, and materials found in Example 5a, what are the recommended vent connector diameters, and is this an acceptable installation?

#### **Solution:**

Table 504.3(4) is used to size common venting installations involving single-wall connectors into masonry chimneys.

**Water Heater Vent Connector Diameter.** Using Table 504.3(4), Vent Connector Capacity, read down the Total Vent Height (*H*) column to 30 feet, and read across the 2-foot Connector Rise (*R*) row to the first Btu per hour rating in the NAT Max column that is equal to or greater than the water heater input rating. The table shows that a 3-inch vent

connector has a maximum input of only 31,000 Btu per hour while a 4-inch vent connector has a maximum input of 57,000 Btu per hour. A 4-inch vent connector must therefore be used.

**Furnace Vent Connector Diameter.** Using the Vent Connector Capacity portion of Table 504.3(4), read down the Total Vent Height (*H*) column to 30 feet and across the 3-foot Connector Rise (*R*) row. Since the furnace has a fan-assisted combustion system, find the first FAN Max column with a Btu per hour rating greater than the furnace input rating. The 4-inch vent connector has a maximum input rating of 127,000 Btu per hour and a minimum input rating of 95,000 Btu per hour. The 100,000 Btu per hour furnace in this example falls within this range, so a 4-inch connector is adequate.

**Masonry Chimney.** From Table B-1, the equivalent area for a nominal liner size of 8 inches by 12 inches is 63.6 square inches. Using Table 504.3(4), Common Vent Capacity, read down the FAN + NAT column under the Minimum Internal Area of Chimney value of 63 to the row for 30-foot height to find a capacity value of 739,000 Btu per hour. The combined input rating of the furnace and water heater, 135,000 Btu per hour, is less than the table value, so this is an acceptable installation.

Section 504.3.17 requires the common vent area to be no greater than seven times the smallest *listed appliance* categorized vent area, flue collar area, or draft hood outlet area. Both appliances in this installation have 4-inch-diameter outlets. From Table B-1, the equivalent area for an inside diameter of 4 inches is 12.2 square inches. Seven times 12.2 equals 85.4, which is greater than 63.6, so this configuration is acceptable.

#### **Example 5c: Common venting into an exterior masonry chimney.**

In this case, the water heater and fan-assisted furnace of Examples 5a and 5b are to be common vented into an exterior masonry chimney. The chimney height, clay tile liner dimensions, and vent connector heights and laterals are the same as in Example 5b. This system is being installed in Charlotte, North Carolina. Does this exterior masonry chimney need to be relined? If so, what corrugated metallic liner size is recommended? What vent connector diameters are recommended?

#### **Solution:**

According to Section 504.3.20, Type B vent connectors are required to be used with exterior masonry chimneys. Use Tables 504.3(7a), (7b) to size FAN+NAT common venting installations involving Type-B double wall connectors into exterior masonry chimneys.

The local 99-percent winter design temperature needed to use Table 504.3(7b) can be found in the ASHRAE *Handbook of Fundamentals*. For Charlotte, North Carolina, this design temperature is 19°F.

**Chimney Liner Requirement.** As in Example 5b, use the 63 square inch Internal Area columns for this size clay tile liner. Read down the 63 square inch column of Table 504.3(7a) to the 30-foot height row to find that the combined *appliance* maximum input is 747,000 Btu per hour. The combined input rating of the appliances in this installation, 135,000 Btu per hour, is less than the maximum value, so this

criterion is satisfied. Table 504.3(7b), at a 19°F design temperature, and at the same vent height and internal area used above, shows that the minimum allowable input rating of a space-heating appliance is 470,000 Btu per hour. The furnace input rating of 100,000 Btu per hour is less than this minimum value. So this criterion is not satisfied, and an alternative venting design needs to be used, such as a Type B vent shown in Example 5a or a *listed* chimney liner system shown in the remainder of the example.

According to Section 504.3.19, Table 504.3(1) or 504.3(2) is used for sizing corrugated metallic liners in masonry chimneys, with the maximum common vent capacities reduced by 20 percent. This example will be continued assuming Type B vent connectors.

**Water Heater Vent Connector Diameter.** Using Table 504.3(1), Vent Connector Capacity, read down the Total Vent Height (*H*) column to 30 feet, and read across the 2-foot Connector Rise (*R*) row to the first Btu/h rating in the NAT Max column that is equal to or greater than the water heater input rating. The table shows that a 3-inch vent connector has a maximum capacity of 39,000 Btu/h. Although this rating is greater than the water heater input rating, a 3-inch vent connector is prohibited by Section 504.3.21. A 4-inch vent connector has a maximum input rating of 70,000 Btu/h and is equal to the draft hood outlet diameter. A 4-inch vent connector is selected.

**Furnace Vent Connector Diameter.** Using Table 504.3(1), Vent Connector Capacity, read down the Vent Height (*H*) column to 30 feet, and read across the 3-foot Connector Rise (*R*) row to the first Btu per hour rating in the FAN Max column that is equal to or greater than the furnace input rating. The 100,000 Btu per hour furnace in this example falls within this range, so a 4-inch connector is adequate.

**Chimney Liner Diameter.** The total input to the common vent is 135,000 Btu per hour. Using the Common Vent Capacity Portion of Table 504.3(1), read down the Vent Height (*H*) column to 30 feet and across this row to find the smallest vent diameter in the FAN+NAT column that has a Btu per hour rating greater than 135,000 Btu per hour. The 4-inch common vent has a capacity of 138,000 Btu per hour. Reducing the maximum capacity by 20 percent (Section 504.3.19) results in a maximum capacity for a 4-inch corrugated liner of 110,000 Btu per hour, less than the total input of 135,000 Btu per hour. So a larger liner is needed. The 5-inch common vent capacity *listed* in Table 504.3(1) is 210,000 Btu per hour, and after reducing by 20 percent is 168,000 Btu per hour. Therefore, a 5-inch corrugated metal liner should be used in this example.

**Single-Wall Connectors.** Once it has been established that relining the chimney is necessary, Type B double-wall vent connectors are not specifically required. This example could be redone using Table 504.3(2) for single-wall vent connectors. For this case, the vent connector and liner diameters would be the same as found above with Type B double-wall connectors.

**TABLE B-1  
MASONRY CHIMNEY LINER DIMENSIONS  
WITH CIRCULAR EQUIVALENTS<sup>a</sup>**

NOMINAL LINER SIZE (inches)	INSIDE DIMENSIONS OF LINER (inches)	INSIDE DIAMETER OR EQUIVALENT DIAMETER (inches)	EQUIVALENT AREA (square inches)
4 × 8	2½ × 6½	4	12.2
		5	19.6
		6	28.3
		7	38.3
8 × 8	6¾ × 6¾	7.4	42.7
		8	50.3
8 × 12	6½ × 10½	9	63.6
		10	78.5
12 × 12	9¾ × 9¾	10.4	83.3
		11	95
12 × 16	9½ × 13½	11.8	107.5
		12	113.0
		14	153.9
16 × 16	13¼ × 13¼	14.5	162.9
		15	176.7
16 × 20	13 × 17	16.2	206.1
		18	254.4
20 × 20	16¾ × 16¾	18.2	260.2
		20	314.1
20 × 24	16½ × 20½	20.1	314.2
		22 ×	380.1
24 × 24	20¼ × 20¼	22.1	380.1
		24	452.3
24 × 28	20¼ × 20¼	24.1	456.2
		26.4	543.3
28 × 28	24¼ × 24¼	27	572.5
		27.9	607
30 × 30	25½ × 25½	30	706.8
		30.9	749.9
30 × 36	25½ × 31½	33	855.3
		34.4	929.4
36 × 36	31½ × 31½	36	1017.9

For SI: 1 inch = 25.4 mm, 1 square inch = 645.16 m<sup>2</sup>.

a. Where liner sizes differ dimensionally from those shown in Table B-1, equivalent diameters may be determined from published tables for square and rectangular ducts of equivalent carrying capacity or by other engineering methods.



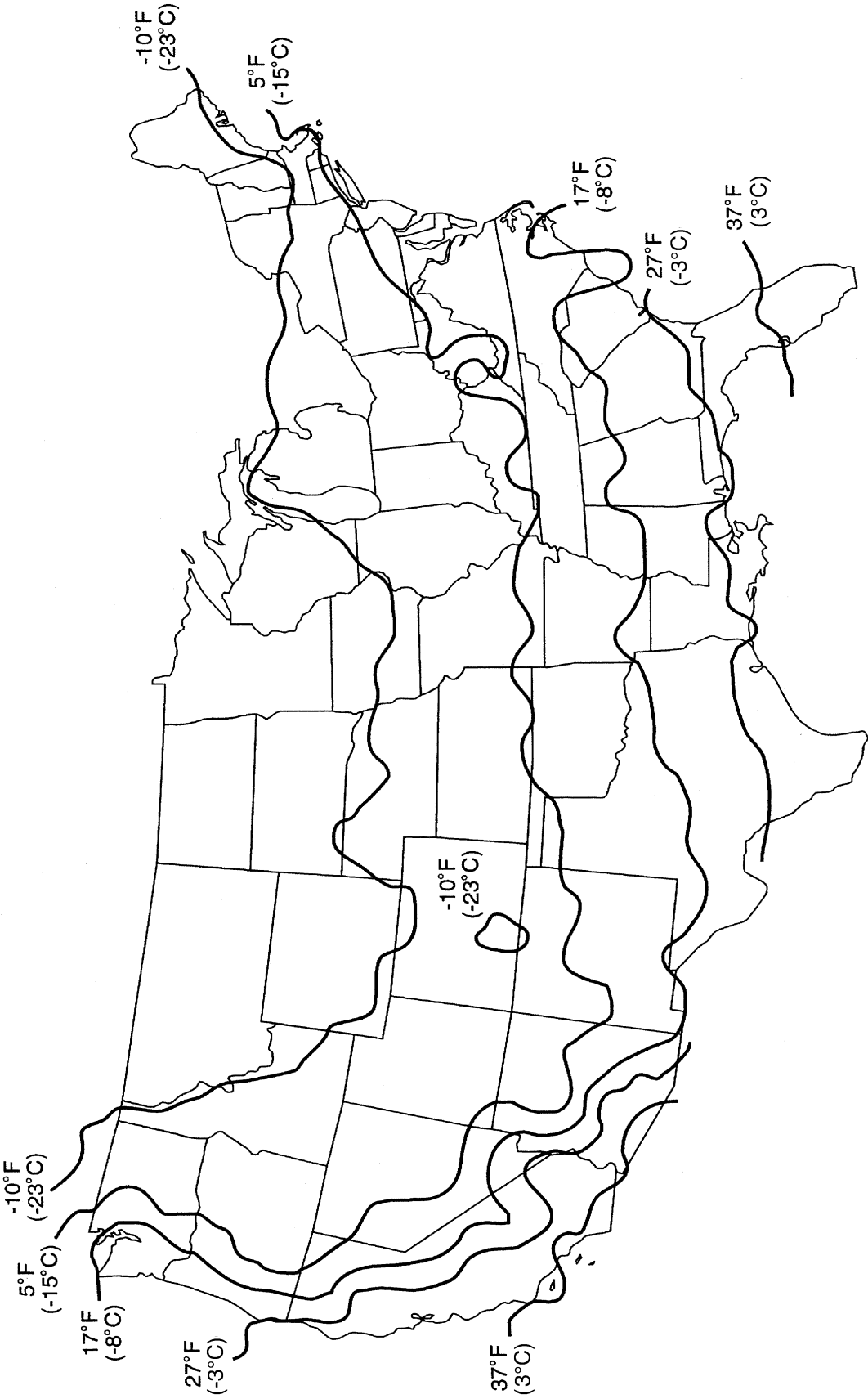

FIGURE B-19

