

# Seattle Parks and Recreation

## Carkeek Park Pedestrian Bridge

### Feasibility Study Report



RHC Engineering



March 12, 2021

# **Carkeek Park Pedestrian Bridge**

## **Feasibility Study Report**

March 2021

### **Prepared for**

Seattle Parks and Recreation  
100 Dexter Ave N  
Seattle, WA 98109

### **Prepared by**

RHC Engineering  
720 Third Avenue, Suite 1400  
Seattle, WA 98104  
206-623-5984

### **With team partners**

LMN Architects, Inc.  
&  
Shannon & Wilson, Inc.

## Table of Contents

Executive Summary.....	1
Project Background .....	1
Project Goals .....	1
Bridge Replacement Recommendation.....	1
1. Introduction.....	3
2. Existing Site Condition and Bridge Assessment.....	3
3. Project Criteria.....	3
Bridge Function.....	3
Bridge Components .....	4
Parking Side Landing Ramp .....	4
Parking Side Landing Stairs.....	4
Bridge Over BNSF Tracks.....	4
Bridge End View Platform .....	4
Beach Side Landing Stairs .....	4
BNSF Clearances .....	4
Vertical Clearance .....	4
Range for Vertical Clearance .....	4
Horizontal Clearance .....	4
Throw Barrier .....	4
Safety Features .....	5
Longitudinal Grade .....	5
Cross Slope.....	5
Bridge Width.....	5
Stairs.....	5
Crime Prevention .....	5
Design Standards .....	5
Design Loads and Combinations .....	5
Dead Load .....	5

Live Load Pedestrian .....6

Live Load Vehicle.....6

Earthquake Load .....6

Wind Load, WS.....6

Snow and Ice Load,.....6

Temperature, TU or TG.....6

Load Combination.....6

Materials .....6

    Concrete.....6

    Reinforcing Steel .....7

    Structural Steel .....7

    Cables.....7

4. Environmental Permitting and Documentation.....7

5. Geotechnical Condition and Foundation Recommendations.....8

6. Site Condition and Constraints.....9

    Park Context.....9

    Bridge Context.....10

    Bridge Visibility.....10

    Site Circulation .....11

    Accessibility .....12

7. Park Integration, Trail Alignment, and Approach Landing .....12

    BNSF Clearance Diagram .....12

    East-West Site Section.....13

    West Viewpoint and Stairs.....16

    Alignment Comparison .....17

    Site Recommendations .....18

8. Superstructure Replacement Study .....19

    Alignment Width Studies.....19

    Throw Barrier Sections.....20

    Superstructure Length.....20



Superstructure Deck Depth .....	20
Superstructure Type Considered: Girder Bridge .....	21
Superstructure Type Considered: Truss Bridge .....	22
Superstructure Type Considered: Arch Bridge .....	23
Superstructure Type Considered: Cable-Stayed Bridge .....	24
Superstructure Comparison .....	25
9. Constructability .....	28
Construction Access .....	28
10. Cost Estimates .....	29
11. Recommendations and Next Steps .....	32
Opportunities for Additional Study .....	32
Next Steps .....	33
12. References .....	33
13. Appendices .....	33
A. Existing Bridge Assessment Report .....	33
B. Geotechnical Memo .....	33
C. Concept Plans .....	33

## List of Figures and Tables

Figure 1 Park Context .....	9
Figure 2 Bridge Context .....	10
Figure 3 Bridge Access .....	11
Figure 4 Bridge Access Detail .....	12
Figure 5 BNSF ROW Plan .....	13
Figure 6 BNSF Clearance Elevation .....	13
Figure 7 Existing Bridge Elevation .....	14
Figure 8 East Approach Access Plan .....	15
Figure 9 East Approach Access Section .....	16
Figure 10 Alignment Study .....	17

Figure 11 Urban Design .....	18
Figure 12 Bridge Sections.....	19
Figure 13 Throw Barrier .....	20
Figure 14 Girder Bridge Configurations.....	21
Figure 15 Truss Bridge Configurations .....	22
Figure 16 Arch Bridge Configurations.....	23
Figure 17 Cable-Stayed Bridge Configurations.....	24
Figure 18 Summary Comparisons for Different Bridge Types.....	25
Figure 19 Truss and Cable-Stayed Bridge Rendering .....	26
Figure 20 Construction Access .....	28
Figure 21 Further Study Diagram .....	32
Table 1: Load Combination .....	6
Table 2: Truss and Cable-Stay Option Comparison .....	27
Table 3: Bridge Replacement Project Cost .....	29
Table 4: Construction Cost Estimates for Cable-Stayed Bridge.....	30
Table 5: Construction Cost Estimates for Truss Bridge .....	31

## Abbreviates

AASHTO	American Association of State Highway and Transportation Officials
ACI	American Concrete Institute
ADA	Americans with Disabilities Act
AISC	American Institute of Steel Construction
ASCE	American Society of Civil Engineers
BNSF	Burlington North Santa Fe Railway
ECA	Environmental Critical Areas
FEMA	Federal Emergency Management Agency
LRFD	Load and Resistance Factor Design
NEPA	National Environmental Policy Act
ROW	Right of Way
SDCI	Seattle Department of Construction and Inspection
SEPA	State Environmental Policy Act
SPR	Seattle Parks and Recreation
USACOE	U.S. Army Corps of Engineers
WDFW	Washington State Department of Fish and Wildlife
WSDOT	Washington State Department of Transportation

This page is intentionally left blank

# Executive Summary

## Project Background

Carkeek Park is a popular park located in the northwest area of the City of Seattle. With numerous trails, an inclusive Puget Sound sandy beach area, and visibility of the BNSF railroad tracks and passing trains, the park is a popular place that attracts a diverse group of community visitors especially children, for variety of activities such as hiking and exploring in the woods, playground use, watching the passing trains and playing water and sand at the beach area.

Connecting the Park's upper land and mountain trails with the lower beach area, the existing Carkeek Park Pedestrian Bridge crosses two pairs of BNSF rail tracks, and was built in 1975 with an existing easement with BNSF. As a part of this study, RHC performed a structural assessment for the existing bridge and estimated the remaining life of the bridge to be approximately three years.

This feasibility study consists of reviewing the existing conditions and developing replacement concepts for the existing Carkeek Park Pedestrian Bridge, which has deteriorated to the extent of requiring a replacement. This study is a collaborative effort by the project team consisting of SPR and RHC Engineering consultant team (RHC).

## Project Goals

The new replacement bridge should create a safe, welcome, and inclusive infrastructure in the iconic Carkeek Park, while providing a beautiful view of the Puget Sound. The vision for the Carkeek Park is to build the new bridge as a signature structure to promote the health and wellbeing of the local communities.

Due to the active BNSF train operations under the bridge, it is difficult to access the bridge for periodic maintenance, and this has resulted in steel corrosion and concrete cracking and spalling. The new replacement bridge should be buildable with reasonable cost, sustainable enough to require low maintenance for an extended bridge life and long-term capital cost saving, and easily accessible for periodic safety inspection.

This feasibility study report included a bridge type, size, and location study for bridge aesthetics, civil and structural engineering, a geotechnical study, environmental permitting documentation, constructability, and planning level cost estimates.

## Bridge Replacement Recommendation

The replacement bridge should preserve the view of Puget Sound to the maximum, and maintain an open view for young children to watch the passing trains. With all considerations including alignment, profile, and bridge sections, RHC screened different bridge alternatives including conventional girder bridges, non-conventional girder bridges, trusses, arches, and cable-stayed bridges. For this unique site, RHC recommends the cable-stayed bridge alternative to achieve SPR's vision for an open space, low maintenance, and cost saving structure. RHC recommends SPR to prioritize the bridge replacement in order to maintain the overpass open, plan ahead of time before the existing bridge's continuing

deterioration requires a complete closure or reaches to the extent to impact BNSF operation.

### **Project Cost**

The estimated construction cost is 2.7 million for the cable-stayed bridge in 2020 dollars. The total project cost is estimated at 4.8 million.

## 1. Introduction

The Carkeek Park Pedestrian Bridge is located between the Broad View and Blue Ridge neighborhoods in the northwest vicinity of Seattle. As a sole access path to the park's popular sandy beach area, the bridge is a popular place for sightseeing of the Puget Sound and the frequent passing trains. The bridge is popular among all types of community members, including seniors, young children, and teenagers.

Access to the bridge for periodic maintenance is constrained, due to its crossing over the active railroad tracks in the BNSF right of way (ROW). This has caused the existing bridge, which was built in 1975, to deteriorate to the point that a replacement is required.

The purpose of this feasibility study is to develop replacement concepts, to preserve the Park's existing pristine features, to improve pedestrian access capacities, and to provide a new sustainable bridge with resiliency to earthquake and mitigated interface with BNSF.

## 2. Existing Site Condition and Bridge Assessment

Carkeek Park is a large area that encompasses up to 10 trails ranging from uphill to downhill, and the adjacent areas of railroad tracks and beach. Features within the bridge vicinity include restrooms, picnic shelters, playground equipment, parking lots, and benches. These features and the view of Puget Sound have attracted frequent park and bridge users. The existing bridge provides a sole access path to the popular sandy beach area facing the Puget Sound. The beach area is an enjoyable place that offers fine sand, ancient driftwood logs, sea shells, and a beautiful view of the Puget Sound.

The existing bridge is five feet wide, and does not meet currently applied six-foot social distancing requirement. The existing bridge has a vertical clearance that is less than what is currently required by BNSF. Some high load dents were visible. In addition, the ramp to the parking lot area has a slope of 14.3 percent, which exceeds the 5 percent ADA requirement.

The intermediate piers are within the BNSF ROW and are costly for routine maintenance. In addition, the main pier foundation on the beach side consists of small footings and will be subject to settlement in the event of a major earthquake. The connections between the precast deck panels and the wide flange beam have leaked and caused moisture accumulation, steel corrosion and concrete spalling. Appendix A summarizes RHC's assessment of the existing bridge.

The existing BNSF easement covers approximately 25 feet in width along the existing structure's centerline. The easement requires that SPR maintains the bridge for the easement to be effective.

## 3. Project Criteria

### Bridge Function

Connecting the park's trail system, parking lot, and playground area, the bridge provides pedestrian access to the beach, a viewing point for Puget Sound, and close observations for passing BNSF trains for all visitors. Serving a diverse community of park users, the bridge should provide a safe path with ADA



access to the bridge's viewing platform.

## **Bridge Components**

### **Parking Side Landing Ramp**

The parking side landing ramp will be built at the sloped grass area adjacent to the existing sidewalk. This landing ramp will be the main entrance to the bridge from the playground and upper view point of the park. This ramp will be ADA compliant and will be on structures to preserve the sufficient view of Puget Sound from the existing sidewalk.

### **Parking Side Landing Stairs**

The parking side landing stairs will function similarly to the existing bridge entrance, with its purpose to provide direct non-ADA access for people entering from the east upper parking lot and from Pipers Creek Trail at the south of the bridge.

### **Bridge Over BNSF Tracks**

The bridge crossing over BNSF tracks is the main span structure that provides access to the beach and an open space for the viewing Puget Sound and passing trains, by all visitors including young children and wheel chair users.

### **Bridge End View Platform**

Similar to the existing bridge's platform area, the new bridge end platform on the beach side will serve two functions: to provide an open space for view entertaining and to act as a structural counterweight to the main span bridge for substructure load balance.

### **Beach Side Landing Stairs**

The beach side landing stairs will provide access from the top of the bridge to the beach. ADA compliance will not be required considering the sandy surface conditions.

## **BNSF Clearances**

### **Vertical Clearance**

BNSF requires the minimum vertical clearance, measured from the highest rail to the lowest point under the bridge, to be 23.5 feet. This clearance is after the bridge deck deflection under loads. Additionally, BNSF expansion for future tracks or reconstruction of existing tracks shall be considered.

### **Range for Vertical Clearance**

Vertical clearance shall be satisfied at a minimum range of nine feet beyond the centerline of the existing or future exterior tracks.

### **Horizontal Clearance**

BNSF requires that the bridge foundation piers shall be located outside of the BNSF ROW whenever feasible. Pier protection measures are needed for a pier within 27 feet of the exterior track centerline.

### **Throw Barrier**

10-foot high vertical throw barriers will be provided on both sides of the bridge crossing over BNSF

ROW.

## Safety Features

### Longitudinal Grade

The longitudinal landing grade at the parking side will be within 5 percent, to provide safe ADA access to the bridge deck.

### Cross Slope

The maximum cross slope will be 2 percent.

### Bridge Width

The width for spans over BNSF tracks will be eight feet to 16 feet, with 10 feet recommended allowing for viewing stops on the bridge and ADA wheel-chair passing, as well as providing sufficient lateral structural stiffness.

### Stairs

Stairs width will be five-foot minimum, with eight-foot ideal for people passing. Stair step and rise will be in accordance with building code standards.

### Crime Prevention

Crime prevention design features include open space design to eliminate potential hiding spaces. These features include open spaces on the bridge, at approaches, and at entries. For under the bridge space, appropriate rock landscaping features are required to achieve low maintenance.

## Design Standards

This feasibility study is established based on the following design criteria documents, in the order of precedence. This list provides major code references and other documents may be referred or required for bridge design and construction.

- AASHTO LRFD Guide Specifications for the Design of Pedestrian Bridges, 2019
- AASHTO Guide Specifications for LRFD Seismic Bridge Design, 2nd Edition, 2011
- AASHTO LRFD Bridge Design Specifications, 8<sup>th</sup> Edition, 2017
- AASHTO LRFD Specifications for Structural Supports for Highway Signs, Luminaires, and Traffic Signals, 1st Edition, 2015 with 2019 Interim Revisions
- WSDOT – Bridge Design Manual, 2020
- AISC – Steel Construction Manual, 15th Edition, 2017
- ACI – 318 Building Code Requirements for Structural Concrete, 2019
- Seattle Building Code, 2015
- ASCE - 7 Minimum Design Loads for Buildings and Other Structure, 2016

## Design Loads and Combinations

### Dead Load

Material self-weight: reinforced concrete: 155 pound per cubic foot; steel: 490 pound per cubic foot, timber: 50 pound per cubic foot; and other materials by manufacture data.

### Live Load Pedestrian

90 pounds per square foot representing pedestrian weight, positioned to create the maximum load effects for a component.

### Live Load Vehicle

AASHTO H5 (10 kips weight) or H10 (20 kips weight) maintenance vehicle loads shall be considered if the clear deck width is over seven feet and is not blocked by physical barriers for vehicle access.

### Earthquake Load

Earthquake response spectrum with 1000 Year return period

### Wind Load, WS

Wind pressure from 1700 year wind speed of 115 miles per hours

### Snow and Ice Load,

Snow load of 25 pound per square foot or ice thickness of 0.5 inches

### Temperature, TU or TG

- Lower Temperature
- High Temperature
- Bridge Construction Temperature

### Load Combination

Table 1: Load Combination

Load Combination	Dead Load	Live Load	Earthquake Load	Wind Load	Temperature Load	Snow or Ice Load
Strength I	1.25	1.75	-	-	-	-
Strength III	0.9/1.25	-	-	1.0	0.5/1.2	-
Extreme I	1.0	0	1.0	-	-	-
Extreme II	1.0	0.5	-	-	-	1.0
Service I	1.0	1.0	-	1.0	1.0/1.2	-
Service II	1.0	1.3	-	-	1.0/1.2	-
Service III	1.0	0.8	-	-	1.0/1.2	-
Service IV	1.0	-	-	1.0	1.0/1.2	-
Fatigue I	-	1.75	-	-	-	-

### Materials

#### Concrete

Precast concrete  $f'c=5,000$  psi

Cast-in-place concrete substructure and foundation  $f'c=4,000$  psi

## Reinforcing Steel

Typical for substructure and foundation: ASTM A-706, Grade 60

Epoxy coated rebar for deck: ASTM A-775

## Structural Steel

- Steel wide flange beams, channels, and angles: ASTM A709– Grade 50W
- Steel tubes: ASTM A847
- Bolts, nuts and washers, shear connectors: ASTM F3125 Grade A325, Type III
- Threaded rods and anchor bolts: ASTM F1554
- Welding electrodes: 70,000 psi low hydrogen electrode
- Other miscellaneous structural steel: ASTM A588, Grade 50

## Cables

ASTM A586 or ASTM A603 galvanized seven wire bridge cables

# 4. Environmental Permitting and Documentation

Construction of the bridge foundations and stairs on the beach side will involve ground disturbance, soil drilling, and concrete pouring. These construction activities could be conducted through a barge from the water for shipping of large drilling cranes, or through the parking side to transport small machines and precast members. Overall, the construction activities should trigger minimum interface with BNSF operation.

Based on discussions with SPR, the bridge construction will be a replacement project through SPR's maintenance program. Except construction permit from the Seattle Department of Construction and Inspection (SDCI), other permits such as Army Corps of Engineers, NEPA, and SEPA will be waived through application for exemptions. Below is a summary prepared by SPR in regards to the environmental permitting needs for the bridge construction.

Shoreline Exemption Permit will be needed from SDCI. SPR will write up the exemption request and submit it to SDCI.

The anticipated work for this project is planned to be above the ordinary high-water line so that no permits will be required from the US Army Corps of Engineers or the Washington State Department of Fish & Wildlife (WDFW). The project will need a construction permit from SDCI.

As there are ECAs on and adjacent to the work area, the bridge construction will be subject to the requirements of the City's ECA Code. The bridge replacement will be considered maintenance and because of this, there may not a need to work in any actual ECAs, the only need would be an ECA exemption.

The project is within 200 feet of the ordinary high-water mark, we are subject to the requirements of the City's Shoreline Master Program. If this were a new bridge where one does not currently exist, we would have to get a Shoreline Substantial Development permit from SDCI. However, because we are replacing an existing structure, we only need a Shoreline Exemption.

Since this project is planning for the replacement of an existing structure this project should be exempt from SEPA. SPR will document this with a SEPA Exemption memorandum and prepare an ECA Exemption.

The application for ECA, SEPA and Shoreline Exemptions could be started once designs have reached the 30 percent phase. The construction permit application will be applied for once the designs have reached the 60 percent phase. The exemptions listed above could also be submitted at the same stage as the construction permit.

SPR will need to arrange a Construction and Maintenance Agreement with railroad owners, BNSF. This agreement will cover all aspects of access and construction plans as well as the agreement surrounding the bridges easement across BNSF property. This agreement will be arranged through coordination with BNSF legal representation Jones Lang LaSalle.

Construction documents will need to be shared with BNSF at each stage of design for review and comment according to their grade separation guidelines and constructions standards. This review will be completed by BNSF staff and legal representation and has an expected four to six-week processing time.

Any access to BNSF property for work outside of the Construction and Maintenance Agreement, such as survey or soil testing, will be coordinated by a Temporary Occupancy Permit. This permit has an expected one-month processing time and will include coordination with the local Roadmaster who is the senior official overseeing any section of track.

Potential conflicts with tribal interests will need to be addressed as the projects approach is determined. If the water is used for project site access, the terms of this work will need to be arranged with tribal representatives, likely the Muckleshoot and Suquamish Fishery divisions. If water access is proposed for construction, coordination with the resource agencies (USACOE & WDFW) will be necessary. This study recommends that construction access for this project be achieved by land.

If the final design requires the removal of any trees, location of additional trees at a replacement rate of two new trees for every one removed will be required.

## 5. Geotechnical Condition and Foundation

### Recommendations

Based on two available borings near the bridge, the soil condition on the beach side is soft and subject to liquefaction under the design earthquake event, therefore deep foundations are required. The soil condition on the parking side is suitable for shallow or deep foundations. Please see the Appendix B Geotechnical Report for soil details and seismic hazard impact.

In summary, shallow foundations are recommended for stairs considering that settlement from earthquake liquefaction will not impact the structural integrity. Deep foundations are recommended at the beach side for the bridge span. Shallow or deep foundations are recommended for the bridge at the parking side. Site specific explorations during final design will confirm these recommendations. Foundations are preferably to be outside of the BNSF ROW. For the bridge site, the BNSF ROW is higher

than the mean high-tide water line. FEMA 100-year flood elevation is within the BNSF ROW at north side of the existing bridge, where the new bridge is proposed. If zero rise is required, the location of the new foundation will have to stay within the BNSF ROW. For the current study phase, the foundation is assumed to be near the BNSF ROW.

## 6. Site Condition and Constraints

### Park Context

Carkeek Park is a special place because of the many ecosystems it spans. Dark green in Figure 1 shows the forested areas, light green the lawn or meadow areas, tan or yellow area the beach, and blue the water. The rail tracks that separate the main body of the park from beach and water access are shown in dark grey. The project site is situated right at the convergence of the ecosystems and trails, and the orange line shows the alignment of the existing bridge over the trail tracks from the meadow to the beach.



Figure 1 Park Context



## Bridge Context

As shown in Figure 2, on the east side, the existing bridge can be approached from the sidewalk, trails (purple dash), and the crosswalk (white dash) that connects to upper parking stairs. Pedestrian pathways to the bridge from the amenities like the amphitheater, play area, restrooms, picnic grove, and lawn occur along and sometimes through the primary vehicular route. The main span of the bridge, over the rail tracks, is a popular destination for people of all ages to watch the trains go by. The west end of the span and top of the stair is commonly occupied by people looking out across the Puget Sound towards Kingston and Whidbey Island.

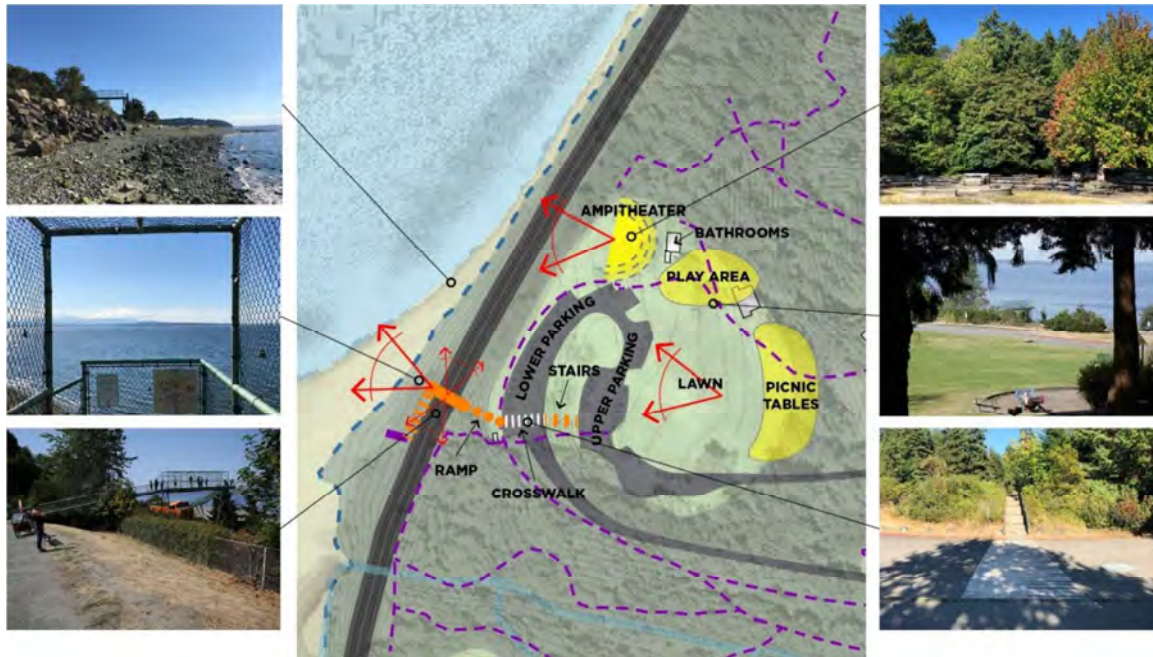

Figure 2 Bridge Context

## Bridge Visibility

As a signature structure, the bridge should have a visible feature, but it should not block the view of Puget Sound.



## Site Circulation

The majority of visitors to the bridge come from the play area and lawn to the north and east, with a smaller portion of pedestrian circulation coming from the southern trails and parking lot. The existing sidewalks are approximately 6.5 feet wide. Visibility of the bridge is limited from the upper lawn due to vegetation and the bridge's lower elevation. More direct lines of sights to portions of the bridge are possible from the play area and amphitheater.

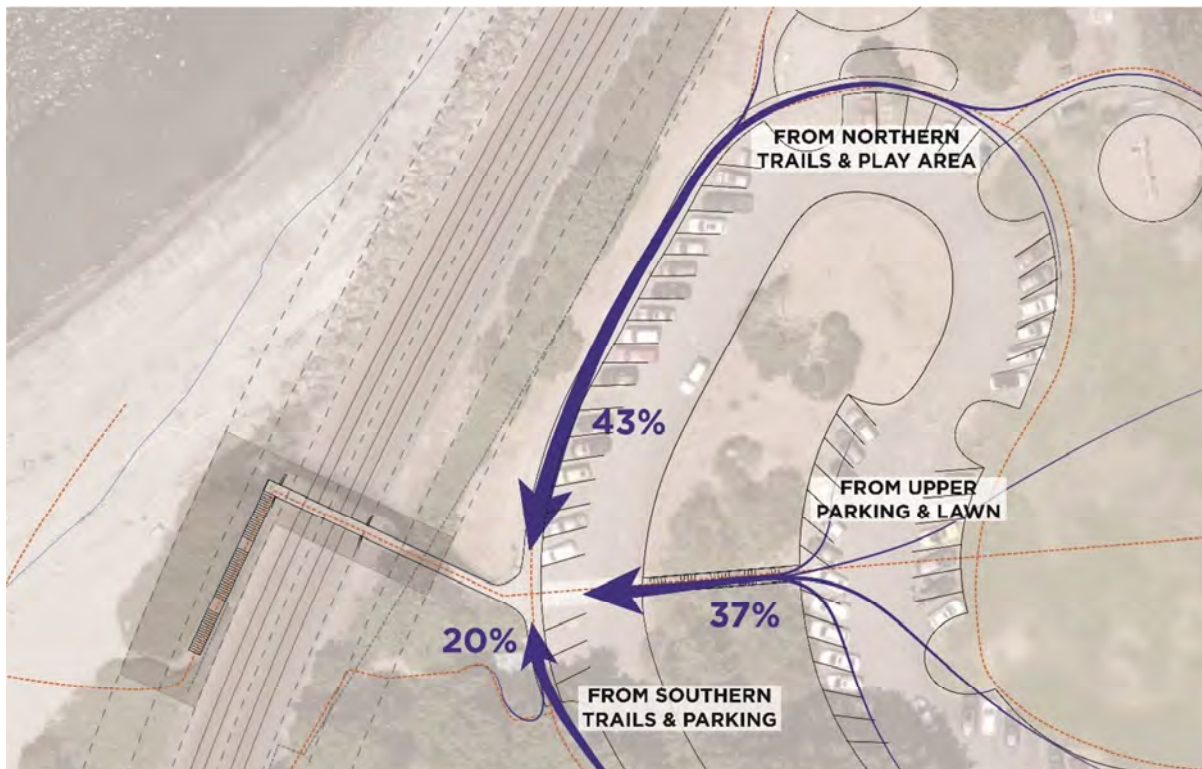

Figure 3 Bridge Access

## Accessibility

The existing bridge design does not currently meet ADA accessibility guidelines. Based on feedback from SPR, this study assumes that the main span of the bridge and western viewpoint should meet ADA accessibility guidelines. The descent from the west viewpoint to the beach will be maintained as stair only access. An accessible ramp, between 5 to 8 percent slope, was studied for the west landing down to the beach and would be on the order of 500 to 700 feet in length. The east side landing would be on the order of 100 feet in length.

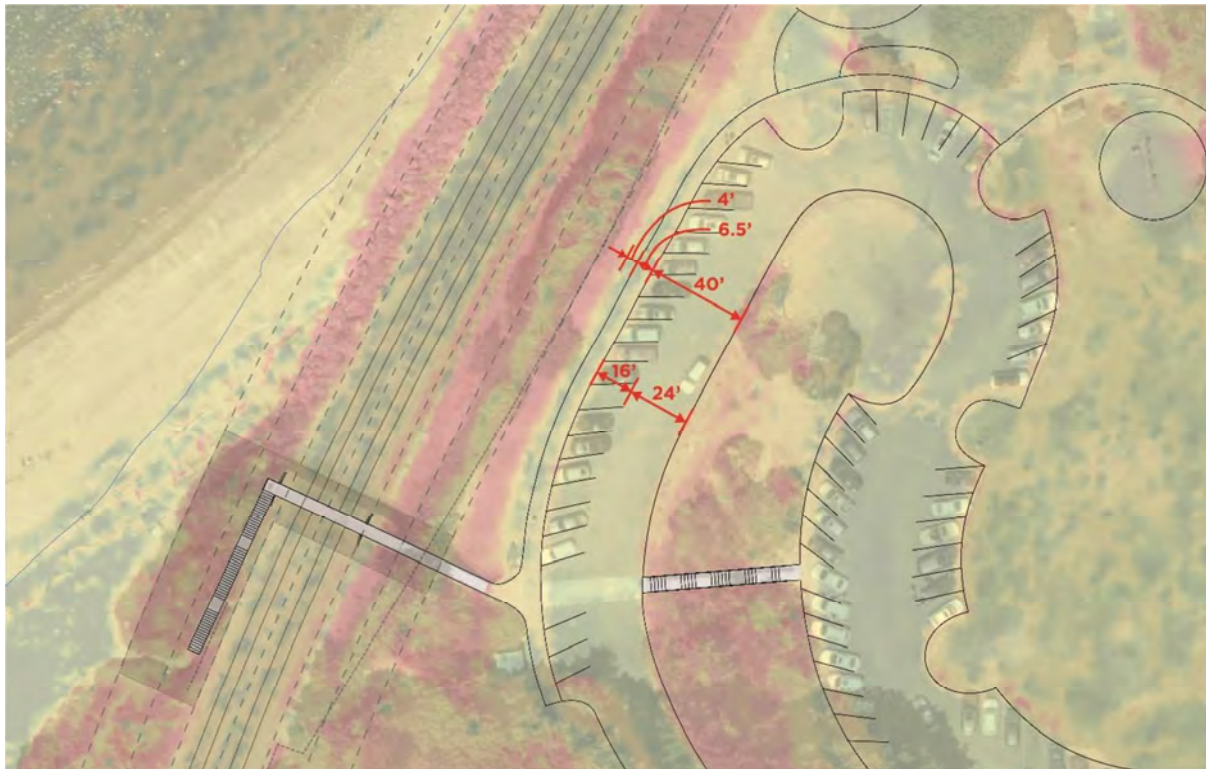

Figure 4 Bridge Access Detail

## 7. Park Integration, Trail Alignment, and Approach Landing

### BNSF Clearance Diagram

Any portion of the new bridge occurring within the BNSF ROW needs to follow the BNSF Guidelines for Railroad Grade Separation Projects. A vertical clearance envelope of at least 23.5 feet, from the top of the track to the bottom of the structure must be maintained within nine feet of the nearest track centerline. A throw barrier, between 8 to 10 feet tall, must be placed on all portions of the bridge within 25 feet of the nearest track centerline or within the ROW. Any construction and maintenance of the bridge occurring within the BNSF ROW require the presence of a BNSF flagger at a cost of roughly \$1,200 per day.



Figure 5 BNSF ROW Plan

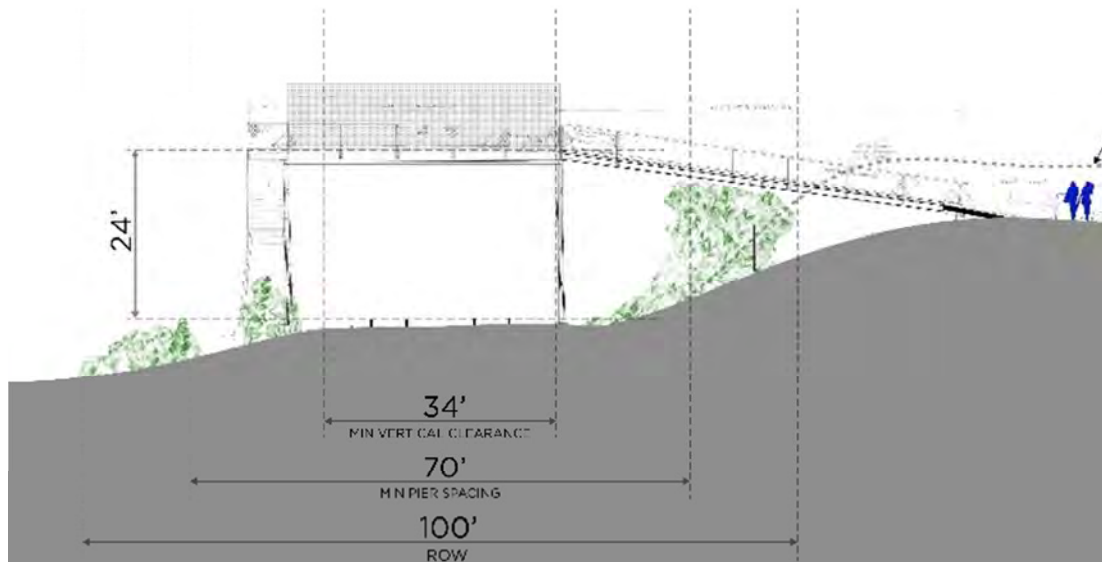

Figure 6 BNSF Clearance Elevation

### East-West Site Section

The existing bridge is accessed from the parking lot on a 14.3 percent slope, which is greater than the maximum ADA accessible slope of 8 percent. The existing bridge is also located within the required BNSF vertical clearance envelope. On the west side of the bridge, the existing stairs are located within



the BNSF zone that is required to be free of piers. The stair descends a total of 28 feet over the course of three stair runs.

For the purposes of this study, it has been assumed that the existing bridge will remain in place while the new bridge is under construction to allow for uninterrupted access to the beach for construction workers and when appropriate, the public. Additional alignments are possible if the existing bridge were to be demolished before construction of the new span, but this approach would complicate construction access to the beach and presents a potential point of contention with the community members who regularly frequent the beach.

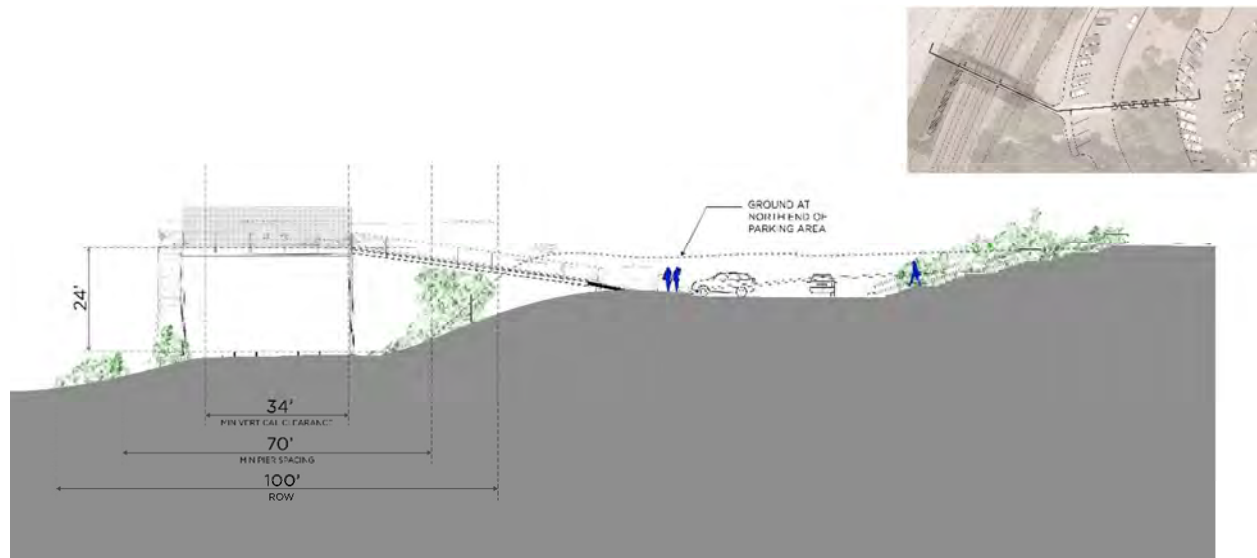

Figure 7 Existing Bridge Elevation

### East Approach

A variety of alignments were studied for accessing the bridge, taking into account the goal of an accessible path to the west viewpoint, the BNSF clearances and ROW, the high-tide line on the west side, and the bridge span criteria. All options used a 4.9 percent sloped walkway along the west edge of the sidewalk at the edge of the parking lot.

The studied configurations of the east approach ramps range from 65 feet to 170 feet in length depending on where the ramp starts along the edge of the parking lot, which increases in elevation by almost 8 feet when moving from south to north. The BNSF tracks are close to the same elevation along their length occurring within the site. The further the ramp starts towards the north end of the parking lot, the less elevation it has to gain to clear the tracks, but the longer the span needs to become to reach the landing point on the west side that is not within close proximity to the high tide line.

There is approximately a 15-foot wide zone for placing the approach ramp between the sidewalk and BNSF ROW. Most of this space occurs on a sloped hillside. The toe of the hill is located along the east edge of the BNSF tracks and within the ROW, creating additional considerations for any foundations that would be constructed for the approach ramp.

The south end of the approach ramp rises between nine feet to 14 feet above the adjacent portion of the sidewalk. Consideration of the pedestrian experience should be given in relationship to these heights for foundations and span types for the approach ramp.

Shifting the main east access point to the north would likely reduce the frequency of parking lot crossings while bringing the bridge entry point closer to the heart of the park.

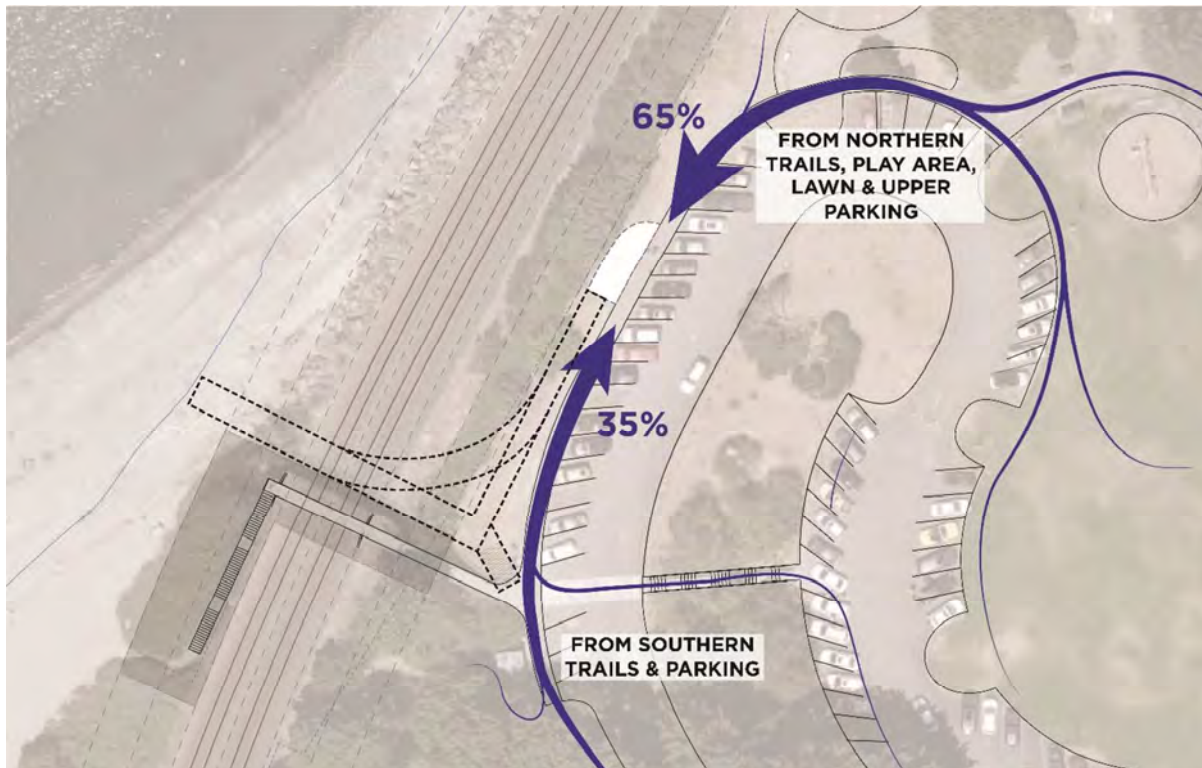

Figure 8 East Approach Access Plan

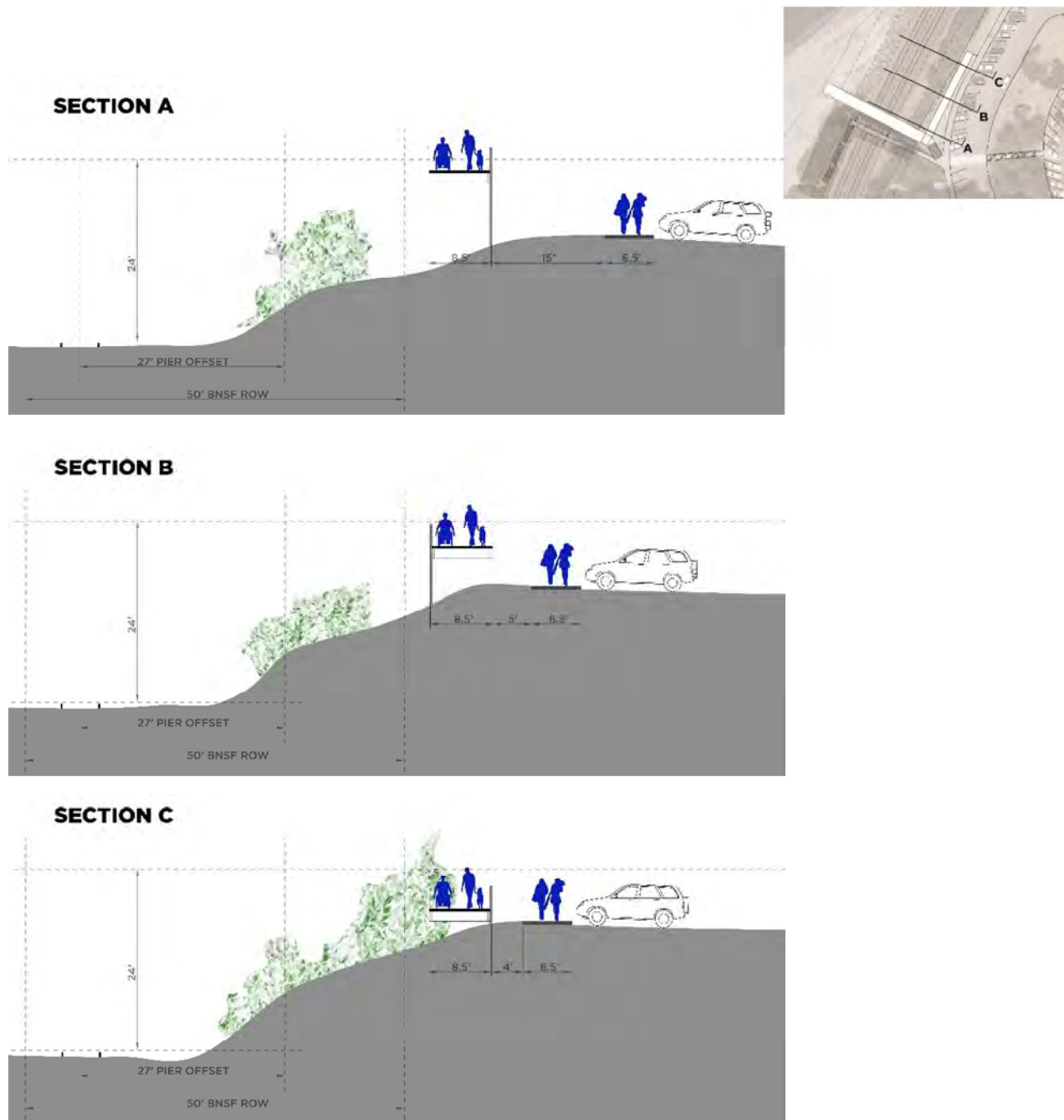

Figure 9 East Approach Access Section

### West Viewpoint and Stairs

The main influences on the west landing are the close proximity to the high-tide line and the minimum BNSF pier support offset. Boring records from other nearby areas of the beach indicate unfavorable soils likely requiring minimally invasive foundation systems like micro-piles. The natural accumulation of driftwood on the beach is an influencing factor in where the structure should touch down. Providing a new stair landing near the existing stair landing creates a comfortable buffer against the high-tide line and fits in with well with the current beach circulation. The new stair will be located further away from

the BNSF tracks and require modification of the existing vegetation occurring along the edge of the beach.

### Alignment Comparison

Four alignments were compared to better understand how the east approach configurations would affect the bridge span and east approach length. In all cases, the west landing location remains consistent due to the limited options available on the west and the goal of retaining access across the existing bridge during construction of the new span.



Figure 10 Alignment Study



## Site Recommendations

For site connections, the following summarizes our recommendations or considerations:

1. West side stair landing and beach access trail
  - a. Will the natural sand be kept as existing or formalized with harder materials?
2. Interpretive plaza
  - a. The base of bridge will naturally act as a gathering element within the park, and it should be considered as places for people to wait without impeding the access to the bridge or sidewalk.
  - b. How does the paved area at the base of ADA ramp connect with the existing sidewalk?
  - c. Possible coordination with Tribes on interpretive elements should be considered.
  - d. Park signage and information on beach habitat and wildlife should be included. This would work as a history and knowledge board area as the existing one.
3. Underbridge and abutment grading and planting
  - a. Low, dense planting, rock landscaping, or sloped ground plane should be considered to discourage occupation.
  - b. It is important to maximize views into the underbridge areas and minimize occupiable places not visible from the main body of the park, to improve the safety features.

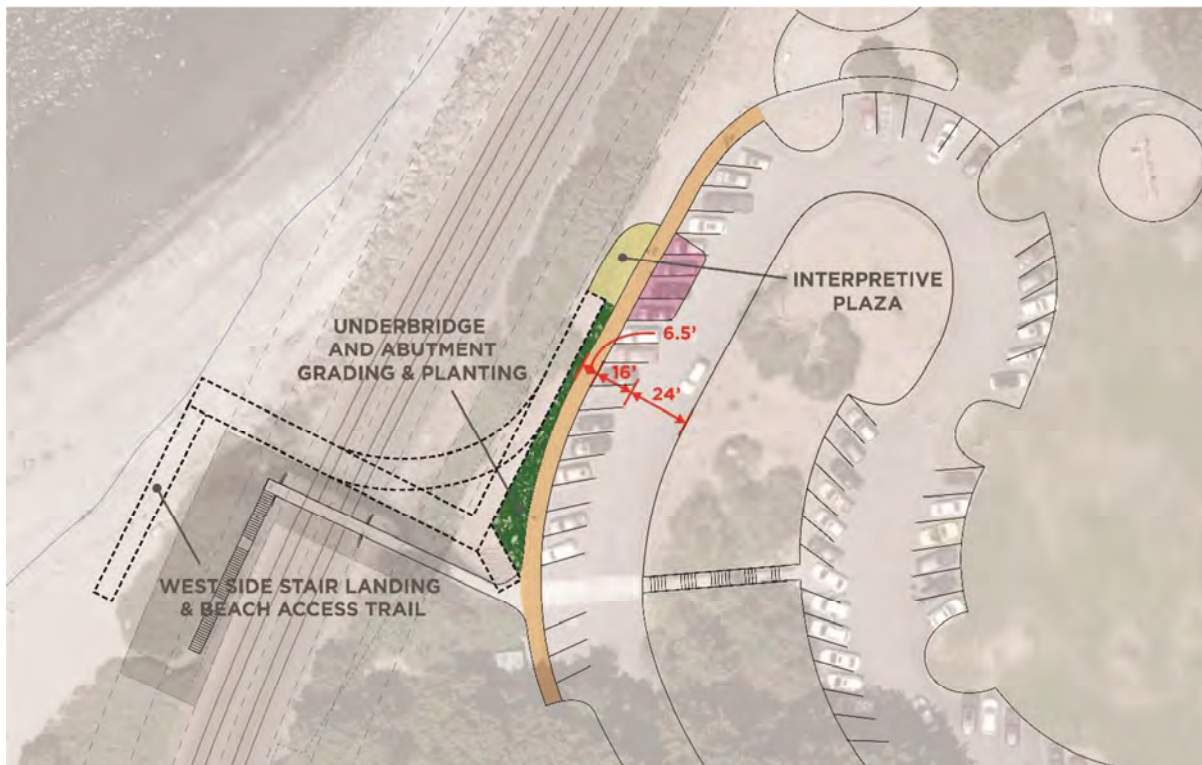

Figure 11 Urban Design

## 8. Superstructure Replacement Study

### Alignment Width Studies

A better alignment would consider ADA access, people pausing along the main span for views, and people carrying large objects like surf boards and coolers. RHC recommends an eight-foot clear width on the approach ramp so that there is clearance for two people on wheels to pass, a ten-foot minimum clear width along the main span so there is space to pause and look at the trains, and a six-foot minimum width on the stairs to the beach as this is not an accessible route for wheelchairs. Figure 12 demonstrates occupancy configurations for different widths of the path.

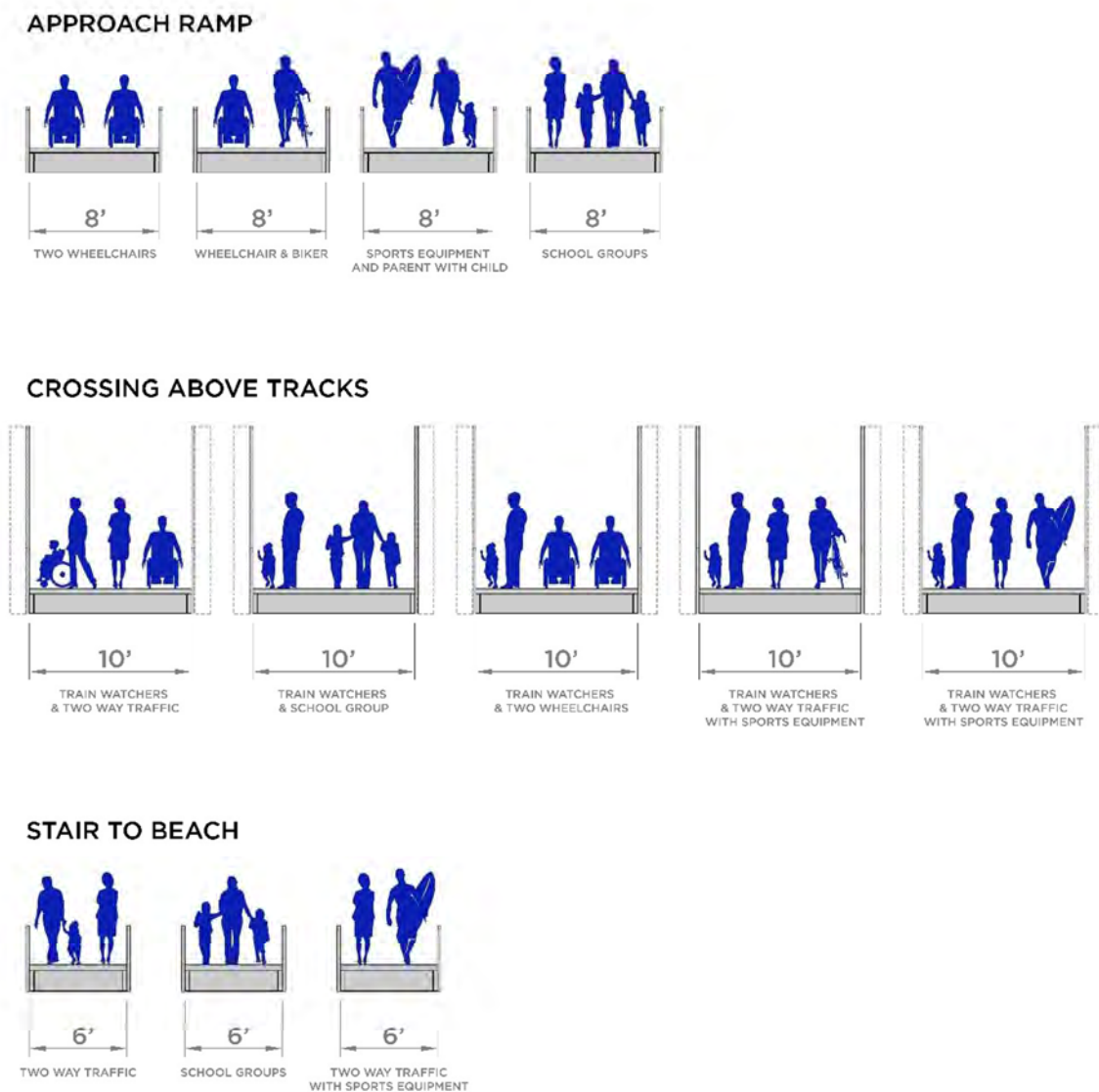

Figure 12 Bridge Sections

## Throw Barrier Sections

The existing throw barrier sections are eight feet tall and closed. For the new construction, BNSF requires either 10' straight or 8' curved shape. RHC recommends the 10-foot straight option for the sense of openness, simpler constructability, and reduced length compared to the 8' curved option. Figure 13 shows the three different throw barriers discussed.



Figure 13 Throw Barrier

## Superstructure Length

The bridge span length will be primarily determined by the alignment over the tracks and relationship to the BNSF ROW. A minimum 27-foot offset from the centerline of the nearest BNSF track must be maintained for any vertical structural support. If any bridge foundation or vertical structural support has an offset less than 27 feet or within the BNSF ROW, it requires an agreement with BNSF to potentially add a collision barrier around the vertical supports, if required by BNSF at a later date. Vertical supports that are outside of the BNSF ROW do not require this agreement, as well as avoid the requirement for a BNSF flagger to be present during construction or future maintenance work. Constructability will also influence the overall span length given what equipment will be able to access the site and be used to lift the span into place.

## Superstructure Deck Depth

The depth of the deck is influenced by the superstructure type, deck material and overall width. The bottom of the bridge deck must be above the 23.5-foot BNSF vertical clearance over the tracks and therefore has a direct influence on the length of the approach ramp needed on the east and the height of the stair on the west.

### Superstructure Type Considered: Girder Bridge

Girder bridges are the most typical types of bridges, as shown in Figure 14. Steel plate girders, steel box or precast prestressed concrete girders or slabs are all appropriate types of girders for this bridge. Girder bridges can be achieved through a deck girder type, where the deck is on top of the girders. Another half-through type lowers the deck between the two girders at two sides of the bridge. A Summary of girder bridges is as follows:

**Pros:** Conventional construction for better constructability and construction resources

**Cons:** Deck girder bridges require deeper depth which will trigger a longer landing ramp and park impact; half-through girder bridges require a deep profile that will block views for young children



GIRDER

Figure 14 Girder Bridge Configurations



### Superstructure Type Considered: Truss Bridge

Traditional truss bridges consist of upper compression chords, lower compression chords, posts and diagonals to carry loads passed from the deck. The deck is typically near the bottom chord. Architectural appealing trusses, such as those shown in the Figure 15, have chord members in different shapes. Trusses can span longer with a low deck profile. Primarily built from steel, trusses are fracture critical structures that are sensitive to damage of one single chord.

**Pros:** Span longer with open space and decent visibility, conventional steel welding or bolt connections, conventional construction

**Cons:** Partial view blocking, constructability with site access constraints, bridge inspection access for taller upper chords, fracture critical structure that is also sensitive to lateral loads due to the height



TRUSS

Figure 15 Truss Bridge Configurations

### Superstructure Type Considered: Arch Bridge

As the name indicates, arch bridges typically include an arch shape main structure, suspended ties for a tie arch or spandrel for a deck arch. The bridge deck is on top of the arch for a deck arch bridge, and the bridge deck is at the bottom of the arch for a tied arch bridge. For the context of this project, a tied arch is an appropriate bridge type. Arch bridges typically represent signatures or icons of the site. Figure 16 shows different appearances of tied-arch bridges.

**Pros:** Span longer with low profile

**Cons:** Partial view blocking, constructability with site access constraints, bridge inspection access for taller upper chords



ARCH

Figure 16 Arch Bridge Configurations

### Superstructure Type Considered: Cable-Stayed Bridge

Cable-stayed bridges include pylons and cables to support a shallow profile bridge deck. Foundations at the pylons carry larger loads and foundations at the bridge ends carry smaller loads. For the context of this project, the pylon and foundation can be constructed on the parking side. Figure 17 shows different configurations of cable-stayed bridges within similar sites as this bridge.

**Pros:** Span longer with low profile, iconic structure, fits the site condition and better constructability

**Cons:** Non-conventional structure to design and build



CABLE STAY

Figure 17 Cable-Stayed Bridge Configurations



### Superstructure Comparison

Figure 18 shows a brief comparison of different bridge types. The truss option and the cable-stayed option fit the context of this bridge therefore they are advanced for further considerations, as shown in Figure 19. Table 2 is a comprehensive comparison of these two types of bridge as they apply to the unique bridge site. Both types have lower profile and have shorter overall bridge length.









	<b>GIRDER</b>		<b>PROS</b>	<b>CONS</b>
	<b>TRUSS</b>		<ul style="list-style-type: none"> <li>• ECONOMICAL SUPERSTRUCTURE</li> <li>• POTENTIAL TO INTEGRATE THROW BARRIER INTO VERTICAL PORTIONS OF TRUSS</li> </ul>	<ul style="list-style-type: none"> <li>• VISUALLY MORE HEFT AND BULK</li> <li>• HEAVIER STRUCTURE TO LIFT INTO PLACE</li> <li>• ADDITIONAL SPANS NEEDED FOR APPROACH RAMP</li> </ul>
	<b>ARCH</b>		<ul style="list-style-type: none"> <li>• LIMITED AMOUNT OF STRUCTURE IN VIEW ZONE</li> </ul>	<ul style="list-style-type: none"> <li>• NEED TO AVOID CABLES IMPINGING ON WALKWAY WHICH INCREASES OVERALL WIDTH</li> <li>• ADDITIONAL SPANS NEEDED FOR APPROACH RAMP</li> </ul>
	<b>CABLE STAY</b>		<ul style="list-style-type: none"> <li>• LIMITS LOAD CARRIED BY BEACH FOUNDATION</li> <li>• ALLOWS FOR CURVED ALIGNMENT</li> <li>• LIGHTER STRUCTURE TO LIFT INTO PLACE</li> <li>• ELIMINATES SEPARATE STRUCTURE</li> </ul>	<ul style="list-style-type: none"> <li>• CAN BE MORE EXPENSIVE</li> <li>• MORE COMPLEX ENGINEERING</li> </ul>

Figure 18 Summary Comparisons for Different Bridge Types



Figure 19 Truss and Cable-Stayed Bridge Rendering



Table 2: Truss and Cable-Stay Option Comparison

	Truss Option	Cable-Stay Option
<b>Bridge and Approach Geometry</b>		
• Span Lengths	Single span over BNSF	Single span over BNSF
• Approach Lengths	Three approach spans	single approach span
<b>Connectivity</b>		
• Beach connection	Yes	Yes
• Trail Network and Park Amenities Integration	Yes	Yes
• Parking Lot and Street Crossings	Yes	Yes
<b>Cost</b>		
• Construction Costs	Slightly higher	Slightly lower
• ROW Impacts	Potential due to flood plain	Potential due to flood plain
• Maintenance Costs	Low	Low
• Corridor Improvement Costs	Potentially trigger the cost	Potentially trigger the cost
<b>Constructability</b>		
• Impact to Vehicular Parking and Vehicular Traffic	Yes	Yes
• Impact to BNSF	Yes	Yes
• Impact to character and function of Park	Yes with positive impact	Yes with positive impact
• Materials Construction Access	Challenging on beach side	Better access on land side
• Construction Staging	In the park near the bridge	In the park near the bridge
• Construction Duration	Longer with a major foundation on beach side	Shorter with the major foundation on parking side
<b>Visual Impact</b>		
• User Experience	Good visibility	Great visibility
• Neighborhood Context	Good	Better with less visual impact
• Bridge and Trail Aesthetics	Good normal truss bridge	Great signature bridge
<b>Environmental Impact</b>		
• Shoreline Area	Potential impact from foundation	Less impact with micropiles
• Bridge and Approach Structures' Foundation Footprint	More foundation prints	Less foundation footprint
<b>Safety</b>		
• Perceived Safety		
o Lighting	Proposed at bridge entrance	Proposed at bridge entrance
o Underbridge area ground treatment	Mix of rock/plant landscape	Mix of rock/plant landscape
• Physical Safety		
o Pedestrian/Vehicle Interaction	No impact	No impact
o Visibility Distance	No impact	No impact

## 9. Constructability

### Construction Access

The unique site makes constructing the bridge a challenging task. The design team has investigated different approaches to access for construction, including helicopter lift, barge through water, utilize the BNSF train, and truck transportation from the NW Carkeek Park Road. Construction activities would be through a period of time and would involve equipment and materials, plus coordination for loading and unloading, therefore helicopter or train transportation of the construction equipment and material would be expensive and are eliminated from further considerations. Equipment access on the beach side of the span will be difficult due to the elevation difference, location of the tracks and natural landscape features. Additionally, water access could be an environmental challenge for barge landings. On the other hand, steep, narrow, and curved roads will make road access a challenge for long span elements like trusses and girders.

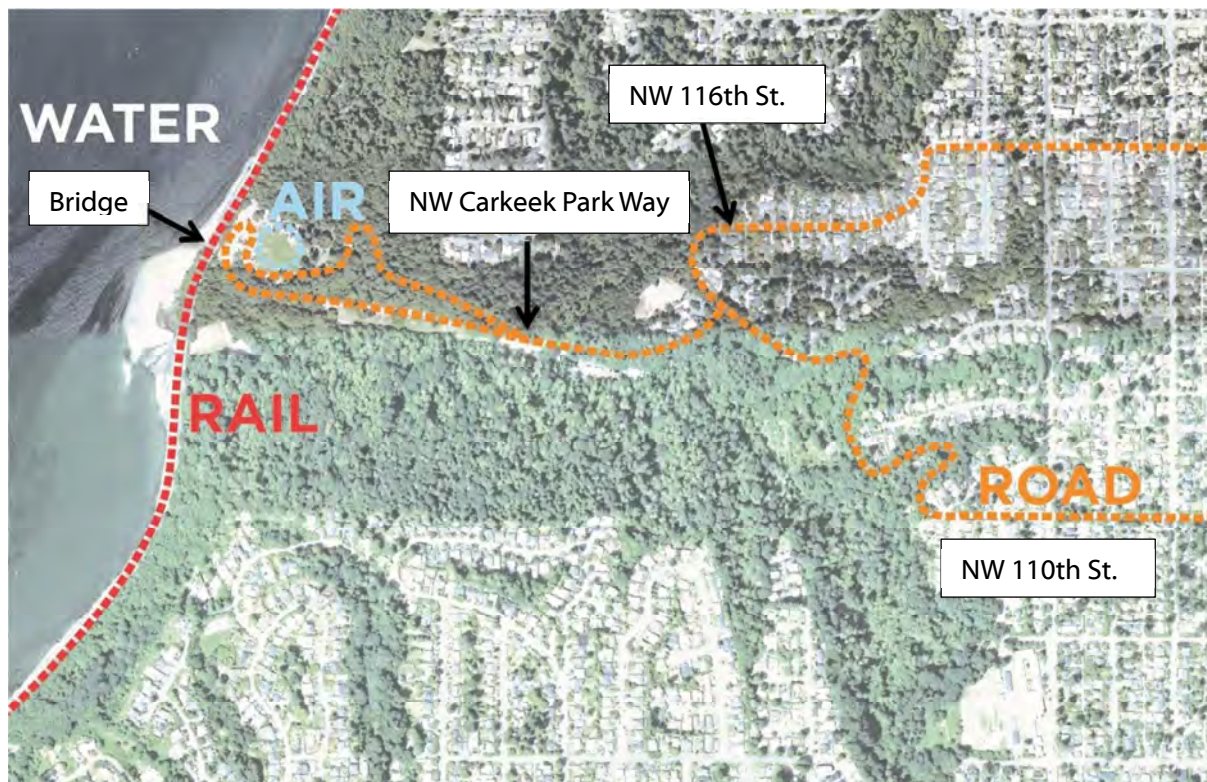

Figure 20 Construction Access

The only roadway to the bridge is from the park entrance through a narrow internal driveway with extreme horizontal curves. Although barge access through water is likely, BNSF tracks are on the way for constructions at the parking side. Due to these constraints, we anticipate shop fabrication of bridge segments, field assembly for full spans without the heavy concrete deck, and lifting to the constructed foundations. The following is a tentative construction sequence we propose:

Proposed construction staging and sequence:

1. Construction access through
2. Setup construction staging area near the parking lot
3. Shop fabrication of bridge members and precast concrete panels
4. Construct the bridge foundations and cable-stayed tower at the park side
5. Construct the bridge foundations at the beach side through barge access or through crane lifted small equipment from the parking lot, primary considerations will be given to use small precast elements to speed up construction and reduce environmental impact
6. Assemble bridge superstructures onsite
7. Remove the existing bridge
8. Crane lift the superstructure and stairs onto the foundations
9. Cable pulling for superstructure elevation control
10. Finish deck concrete and install throw barriers and handrails

## 10. Cost Estimates

Based on our preliminary analysis for superstructure and substructure component sizes, Table 2 is the anticipated project cost, Tables 3 and 4 summarize construction cost estimates for the two options selected and studied in this report. These cost estimates include major construction activities only, with unit cost built in for each fully furnish of each construction item. Conventionally it has been recognized that a truss bridge would cost less than a cable-stayed bridge. Due to the unique site conditions, we have found that a cable-stayed bridge costs reasonable low and will provide an open span for the area.

**Table 3: Bridge Replacement Project Cost**

ITEM	COST
Bridge Construction Cost	\$ 2,494,998
Corridor and Roadway Improvement	\$ 124,750
Landscaping	\$ 74,850
Lighting/Electrical	\$ 24,950
Historical Exhibition Board	\$ 24,950
<b>Base Construction Cost (2020)</b>	<b>\$ 2,744,498</b>
Other Soft Cost	
BNSF Cost (15%)	\$ 411,675
Planning Phase Cost (3.6%)	\$ 98,802
Design Phase Cost (25.45%)	\$ 698,475
Construction Phase Cost (32.01%)	\$ 878,514
Closeout Phase Cost (0.36%)	\$ 9,880
<b>Total Project Cost (2020)</b>	<b>\$ 4,841,843</b>

Table 4: Construction Cost Estimates for Cable-Stayed Bridge

ITEM	UNIT	QUANTITY	UNIT COST	COST
SHORING OR EXTRA EXCAVATION	SF	2400.00	\$ 20.00	\$ 48,000
STRUCTURAL EXCAVATION INCL. HAUL	CY	222.22	\$ 85.00	\$ 18,889
MICROPILE FOUNDATION - 9 INCHES	LF	240.00	\$ 200.00	\$ 48,000
CONCRETE CLASS 4000 - SPREAD FOOTING FOUNDATION	CY	44.44	\$ 750.00	\$ 33,333
CONCRETE CLASS 4000 - BRIDGE COLUMN AND CAP	CY	38.09	\$ 850.00	\$ 32,373
CONCRETE CLASS 4000 - TOWER	CY	41.48	\$ 1,000.00	\$ 41,481
STEEL CABLES	LB	10714.40	\$ 50.00	\$ 535,720
STRUCTURAL STEEL - BRIDGE DECK	LB	30898	\$ 20.00	\$ 617,960
CONCRETE CLASS 5000D - BRIDGE DECK	CY	51.85	\$ 1,000.00	\$ 51,852
CONCRETE CLASS 4000 - PLATFORM	CY	10.67	\$ 850.00	\$ 9,067
CONCRETE CLASS 4000 - STAIR FOOTING	CY	20.00	\$ 750.00	\$ 15,000
CONCRETE CLASS 4000 - STAIR STEP	CY	11.85	\$ 750.00	\$ 8,889
CONCRETE CLASS 4000 - STAIR PIER PEDESTAL	CY	17.28	\$ 750.00	\$ 12,963
STRUCTURAL STEEL - STAIR	LB	14000.00	\$ 5.00	\$ 70,000
BRIDGE PEDESTRIAN BARRIER - 10 FT	LF	200	\$ 750.00	\$ 150,000
BRIDGE AND STAIR PEDESTRIAN BARRIER - 3 FT 6 INCHES	LF	725	\$ 150.00	\$ 108,782
STEEL REBAR	LB	7746.57	\$ 1.50	\$ 116,920
<b>TOTAL CONSTRUCTION COST</b>				<b>\$ 1,919,229</b>
<b>TOTAL CONSTRUCTION COST WITH CONTIGENCY (30%)</b>				<b>\$ 2,494,998</b>

Table 5: Construction Cost Estimates for Truss Bridge

ITEM	UNIT	QUANTITY	UNIT COST	COST
SHORING OR EXTRA EXCAVATION	SF	4000.00	\$ 20.00	\$ 80,000
STRUCTURAL EXCAVATION INCL. HAUL	CY	370.37	\$ 85.00	\$ 31,481
DRILLED SHAFT FOUNDATION - 3 FT	LF	60.00	\$ 1,500.00	\$ 90,000
CONCRETE CLASS 4000 - BRIDGE FOOTING	CY	41.48	\$ 750.00	\$ 31,111
CONCRETE CLASS 4000 - BRIDGE COLUMNS AND CAPS	CY	34.40	\$ 850.00	\$ 29,236
STRUCTURAL STEEL - TRUSS	LB	35202	\$ 20.00	\$ 704,041
STRUCTURAL STEEL - BRIDGE DECK	LB	30898	\$ 20.00	\$ 617,960
CONCRETE CLASS 4000D - BRIDGE DECK	CY	51.85	\$ 1,000.00	\$ 51,852
CONCRETE CLASS 4000 - PLATFORM	CY	10.67	\$ 850.00	\$ 9,067
CONCRETE CLASS 4000 - STAIR FOOTING	CY	20.00	\$ 750.00	\$ 15,000
CONCRETE CLASS 4000 - STAIR PIER	CY	11.85	\$ 750.00	\$ 8,889
CONCRETE CLASS 4000 - STAIR STEP	CY	17.28	\$ 750.00	\$ 12,963
STRUCTURAL STEEL - STAIR	LB	14000.00	\$ 5.00	\$ 70,000
BRIDGE PEDESTRIAN BARRIER - 10 FT	LF	200	\$ 750.00	\$ 150,000
BRIDGE AND STAIR PEDESTRIAN BARRIER - 3 FT 6 INCHES	LF	725	\$ 250.00	\$ 108,782
STEEL REBAR	LB	62026.04	\$ 1.50	\$ 93,039
TOTAL COST				\$ 2,175,943
TOTAL CONSTRUCTION COST WITH CONTIGENCY (30%)				\$ 2,828,726



## 11. Recommendations and Next Steps

This feasibility study reviewed the existing site conditions and studied two replacement alternatives, one for a truss bridge, and one for a cable-stayed bridge, considering their low profile to reduce the landing approach length. When developing the alternatives, constructability, low maintenance, and mitigation of permanent BNSF easement are achieved by using precast concrete for the bridge deck and stair steps, spanning over the BNSF ROW, and focusing major construction activities on the parking side. Ultimately, we recommend the cable-stayed bridge option due to its open space, low deck profile, utilizing better soil for foundation at the parking side, and the signature feature. Here is summary of considerations for the replacement study:

### Opportunities for Additional Study

There are a number of opportunities for additional study as the project moves into design and even after construction. These improvements could be considered as part of other capital planning or on their own as the access needs change over time. These additional considerations can be considered during next phase of the project. These include:

1. Bridge materials, throw barriers integration with structure, and views to/from bridge with structure recommendation
2. East side stair and landing
3. West side ADA ramp to beach connection
4. Enhanced parking lot crossings (upper and lower)
5. Enlarged landing plaza
6. Enhanced sidewalk connection

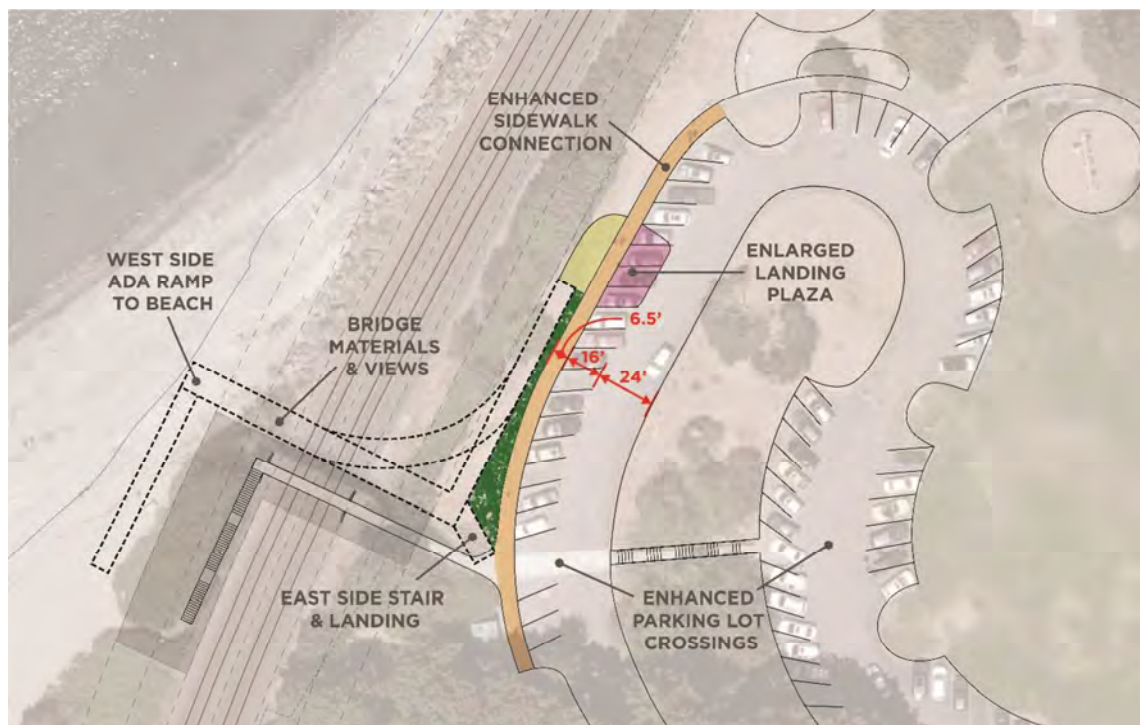

Figure 21 Further Study Diagram



## Next Steps

With a limited life span for the existing bridge, we recommend the final design and construction to be scheduled and prioritized. We anticipate one to one and half years are needed for final design and one to one half years are needed for the construction.

## 12. References

- BNSF Railway Guidelines for Railroad Separation Projects, 2016
- Seattle Right-of-Way Improvements Manual, 2019
- City of Seattle Standard Plans for Municipal Construction, 2020
- City of Seattle Standard Specifications for Municipal Construction, 2020
- WSDOT Design Manual 1515 - Shared Use Path, 2020

## 13. Appendices

- A. Existing Bridge Assessment Report
- B. Geotechnical Memo
- C. Concept Plans

## **Appendix A**

### **Existing Bridge Assessment Report**

# Appendix A

## Seattle Parks and Recreation Carkeek Park Pedestrian Bridge Assessment



**RHC Engineering**

March 12, 2021

## Summary

The Carkeek Park Pedestrian Bridge is a steel structure built around 1975. The bridge connects the park's parking area with the beach area that faces Puget Sound. The bridge is five feet wide, 98 feet long, and consists of three spans crossing over two pairs of BNSF railroad tracks, as well as a 70-foot-long landing stair to the beach.

The purpose of this assessment is to evaluate the existing structural capacities to resist pedestrian live load and earthquake loads, in order to provide information on timing and availability for the new replacement bridge construction.

This assessment report summarizes the review of the bridge as-built data, recent bridge inspection reports, field verification of bridge conditions, and structural analysis and primary load carrying members.

The primary findings from the assessment are deterioration at different connection locations. These locations are not readily accessible for periodic maintenance. Deterioration in steel material includes corrossions at the top flange between the concrete and steel beam, particularly where water can penetrate and accumulate, such as joints and anchor bolts. Deterioration in concrete material includes cracking and spalling.

Our observations of the bridge were based on visual inspection and instrument measurements of effective section thickness, at readily accessible locations. Due to the height of the bridge and active tracks below the bridge, some critical connections between the steel beams and the supporting piers below the deck were not visible. Based on the visibly deteriorated conditions at structural members and connections, we recommend replacing the bridge within three years, although we have not found an immediate need to close the bridge. We also recommend repairing Pier A-4 pipe base and installing load limitation post for the bridge.

## Table of Contents

Summary.....	2
Bridge Description.....	5
Existing Information Review.....	5
Bridge As-Built Drawing.....	5
Bridge Inspection Report.....	6
Field Verification.....	6
Bridge Structural Assessment.....	11
Assessment Criteria.....	11
Loads and Combinations.....	11
Material Properties.....	12
Capacities.....	12
Structural Analysis.....	12
Summary of Assessment Results.....	13
Conclusions.....	15

## Appendices

- A1. Bridge As-Built Drawing
- A2. Bridge Inspection Report
- A3. Bridge Field Visit Memo and Other Backup Information

## List of Tables

Table 1 Load Combination Factors.....	12
Table 2 Summary of Capacity over Demand (C/D) ratios .....	13
Table 3 Live Load Rating Summary.....	14
Table 4 Steel Corrosion Rate (WSDOT BDM Table 6.7-1).....	14

## List of Figures

Figure 1 Bridge Overview .....	5
Figure 2 Deck and Fence.....	7
Figure 3 Bridge Steel Beam Bottom Flange Dent.....	7
Figure 4 Bridge Low Clearance .....	8
Figure 5 Corrosion and Spalling at Bolt Connection with Precast Slab .....	8
Figure 6 Pier with Corrosion Members at the Other Side of BNSF Tracks .....	9
Figure 7 Corrosion at Pier Pipe Base Plate Anchor.....	9
Figure 8 Corrosion at Pier Pipe Base with Visible hole.....	10
Figure 9 Corrosion at Steel Beam Top Flange .....	10
Figure 10 Field Measurement of Steel Thickness .....	11
Figure 11 Existing Bridge Analysis Model.....	13
Figure 12 Existing Bridge Pier Locations .....	15

## Bridge Description

The bridge superstructure consists of steel plate girders and precast concrete deck panels. Hand rails and throw fences are on both sides of the bridge. The bridge substructure consists of braced steel pipes. The bridge foundation consists of reinforced concrete spread footing and pedestals to support the steel pipes. Figure 1 shows a view of the bridge from the sidewalk of the parking area.



Figure 1 Bridge Overview

## Existing Information Review

### Bridge As-Built Drawing

The bridge as-built drawings indicated that the bridge was built in 1975 based on an existing design drawing developed in 1955. The vertical clearance to the rail track is 22 feet 10 inches. The distance from the main span pier to the railroad track is 10 feet, which differs from the field measurement of approximately 12 feet.

The precast deck panel is five feet wide and seven feet long for each, with a thickness of 3.5 inches and a single layer of #4 rebar. The panel was bolted onto the wide flange beam by four bolts at the four corners, and the bolts were sleeved from the concrete. This sleeved connection may have contributed to water leaking and steel corrosion.



The welding connection details between the steel members are not completely detailed in the as-built drawings.

### **Bridge Inspection Report**

Bridge inspection reports spanning from year 2015 through 2020 were reviewed.

The WSDOT Bridge Inspection Manual uses four Condition states, from 1 to 4, to represent good, repaired, fair, and poor status for a structural component. A Condition State 3 indicates fair conditions without immediate structural safety concerns. A Condition State 4 indicates poor conditions, possible structural failure and demands immediate closure of the bridge.

In these bridge inspection reports, over 50 percent of the concrete deck area has the Condition State of 3, which indicates fair condition, or significant defects that require continued attention or repair in order to prevent failure.

There was an increase in the quantity of steel beams with Condition State 3 in the 2018 report, from one percent to thirty percent of the total length of the steel beams.

Corrosion in the pier pipes is consistent with field observations.

Overall, the Superstructure Condition Rating has been decreased from a 7 in year 2017 to a 6 in year 2018. Our field observations indicated the overall rating should be a 5 or less, which represents fair to poor conditions with advanced section loss, deterioration or spalling. This is right next to Condition 3, which represents serious section losses in primary structural members that may impact the structural integrity.

### **Field Verification**

Bridge deterioration is the worst in the structural connections, where water penetration has caused significant corrosion at the concrete deck and steel beam interface, and at the steel welding between pier steel tubes and the connection plates. Figures 2 to 10 show some representative captured locations.





Figure 2 Deck and Fence



Figure 3 Bridge Steel Beam Bottom Flange Dent





Figure 4 Bridge Low Clearance



Figure 5 Corrosion and Spalling at Bolt Connection with Precast Slab





Figure 6 Pier with Corrosion Members at the Other Side of BNSF Tracks



Figure 7 Corrosion at Pier Pipe Base Plate Anchor





Figure 8 Corrosion at Pier Pipe Base with Visible hole



Figure 9 Corrosion at Steel Beam Top Flange





Figure 10 Field Measurement of Steel Thickness

## Bridge Structural Assessment

### Assessment Criteria

The structural assessment includes evaluating the primary load carrying member's capacity and demand, based on the following standards:

- AASHTO LRFD Guideline Specifications for the Design of Pedestrian Bridges, 2019
- AASHTO LRFD Bridge Design Specifications, Eighth Edition, 2017
- AASHTO Manual for Bridge Evaluation, Third Edition, 2018
- Washington State Bridge Inspection Manual, 2020

Capacities of members for the as-built condition and for the reduced section considering corrosion loss were evaluated. The components evaluated included the concrete deck, the longitudinal steel wide flange beams under the deck, the pier pipes, and the spread footing foundation soil bearing. The following sections summarize the structural analysis and results.

### Loads and Combinations

A CSI Bridge analysis model was built to evaluate the load demands under pedestrian live loads and lateral loads including seismic and wind effects. The following load combinations and factors were used (Table 1). Wind load combination does not typically control over seismic loads combinations, based on



our engineering judgment and due to the shallow profile. To evaluate the remaining bridge life before the replacement occurs, we added wind load combination with Strength III Limit State. The analysis is based on the following parameters:

- Live load 90 pounds per square foot
- Wind load per AASHTO standard with 115 mph wind speed and exposure B
- Seismic loads per AASHTO standard response spectrum with an assumed site Class D

**Table 1 Load Combination Factors**

Limit State	Dead Load	Live Load	Wind Load	Earthquake Load
Strength I	1.25	1.75		0
Strength III	1.0		1.0	
Extreme I	1.0	0		1.0

Due to member connections' unknown conditions, fatigue check at these connections was not performed. For the existing bridge, strength and extreme event limit state load combinations should provide reasonable quantifications for the structural safety evaluation.

### Material Properties

- Structural steel yield strength:
  - ASTM A441 steel:  $F_y=36$  ksi
  - ASTM A36 steel:  $F_y=36$  ksi
- Concrete:  $f'_c=4,000$  psi
- Steel Reinforcement:  $F_y=40$  ksi
- Allowable soil bearing pressure: 400 pound per square foot

### Capacities

The primary member capacities were evaluated based on the current bridge design codes, using the material properties assumed above. For the wide flange beams, top flange thickness is reduced by 50 percent. For the pier pipes, the section thickness is reduced to 0.18 inches.

### Structural Analysis

Structural analysis was performed using CSI Bridge software to evaluate the load demands. The structural analysis assumed fixed foundation conditions without considering soil responses, and the section reduction was not considered in the model. This is a reasonable assumption considering that significant corrossions occurred at isolated locations.

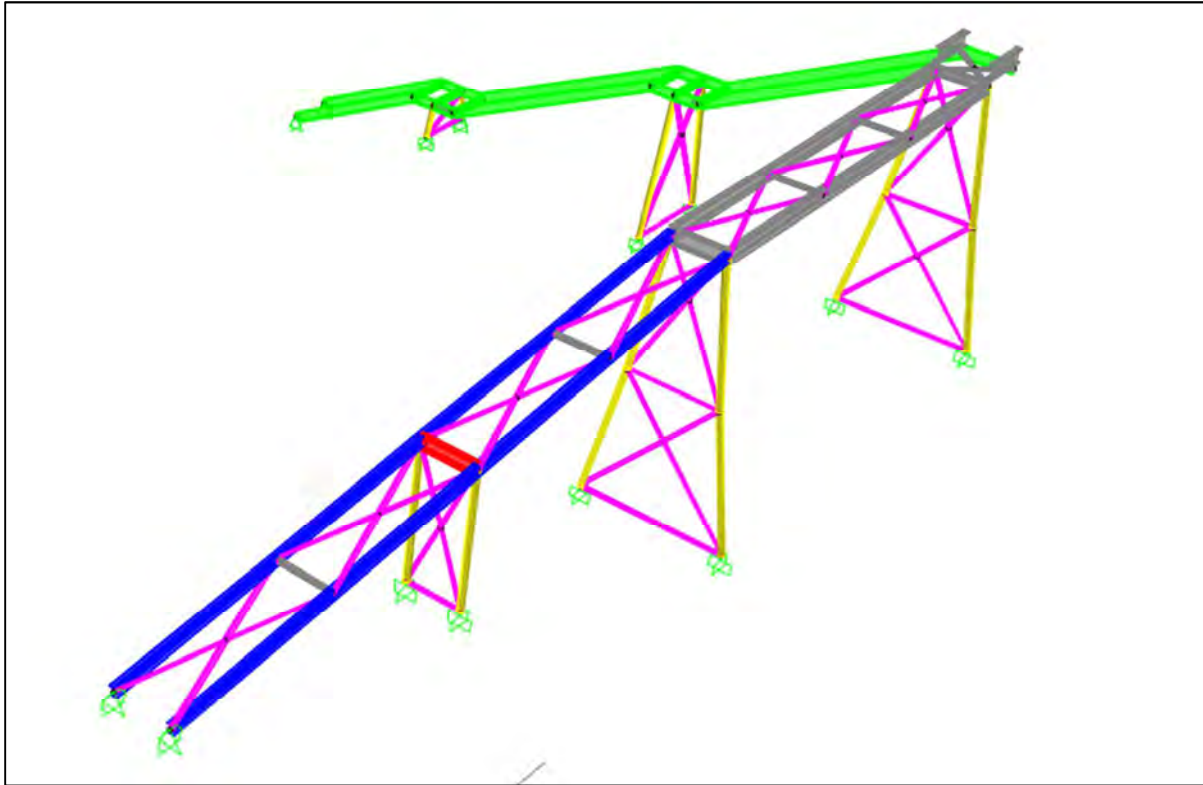

Figure 11 Existing Bridge Analysis Model

## Summary of Assessment Results

Table 2 summarizes the capacity over demand (C/D) ratios under existing conditions after section reductions. For most members, the calculated capacity exceeds the demand, which indicates member sufficiency. Note that the CD ratios are for the primary structural members only. Structural connections are not evaluated due to unknown design detail and current conditions. These may affect the assumptions for the analysis model, and therefore affect the analysis results.

Table 2 Summary of Capacity over Demand (C/D) ratios

Major Components	Unit	Capacity (C)	Strength I Limit State		Extreme I limit State		Strength III limit State	
			Demand (D)	C/D	Demand (D)	C/D	Demand (D)	C/D
Beam WF14X34 Flexural	ksi	26.93	29.44	0.91	5.62	4.79	13.04	2.07
Beam WF14X34 Shear	kips	80.45	13.23	6.08	4.52	17.80	5.76	13.97
Beam WF10X25 Flexural	ksi	20.90	40.82	0.51	8.63	2.42	18.95	1.10
Beam WF10X25 Shear	kips	49.39	10.28	4.80	3.15	15.68	4.3	11.49
Pipe Support	Unitless	1.00	1.13	0.89	0.43	2.35	0.52	1.92
Beam C12X20.7 Flexural	ksi	36.00	16.97	2.12	8.93	4.03	4.04	8.91
Beam C12X20.7 Shear	kips	65.36	3.61	18.10	2.28	28.67	2.13	30.68
Foundation Bearing	ksf	0.4	3.01	0.13	2.06	0.00	1.94	0.21

**Table 3 Live Load Rating Summary**

Major Components	Live Load Rating				
	Unit	Capacity ( C )	Dead Load Demand (D_DL)	Live Load Demand (D_LL)	Load Rating Factor (LR)
Beam WF14X34 Flexural	ksi	26.93	10.75	18.69	0.87
Beam WF14X34 Shear	kips	80.45	5.10	8.13	9.27
Beam WF10X25 Flexural	ksi	20.90	15.68	25.15	0.21
Beam WF10X25 Shear	kips	49.39	3.79	6.49	7.02
Pipe Support	Unitless	1.00	0.33	0.80	0.84
Beam C12X20.7 Flexural	ksi	36.00	4.175	12.80	2.5
Beam C12X20.7 Shear	kips	65.36	2.875	0.74	85.0
Foundation Bearing	ksf	0.4	1.59	1.42	Negative

Some equations for the Tables 2 & 3 are:

Pipe combined axial, flexural, and shear check:  $P_u/P_r + 8/9(M_{ux}/M_{rx} + M_{uy}/M_{ry}) + (V_u/V_r)^2 < 1$

Beam flexural check:  $f_{bu} + f_l/3 < f_{rc}$

Pedestrian live load rating factor  $LR = (C - D_{DL}) / D_{LL}$

Where  $P_u, P_r$  represent axial load and resistance

$M_u, M_r$  represent moment load and resistance in the direction considered

$V_u, V_r$  represent total shear load and resistance

$f_{bu}, f_l,$  and  $f_{rc}$  represent vertical flange compression stress from load, lateral flange compression stress from load, and flange compression resistance

As shown in Table 2 above, the superstructure's wide flange beams, substructure pipe support and foundation bearings have less capacity than Strength 1 Design demands, which includes full pedestrian loads. The foundation bearing is not sufficient for all load combinations. To further evaluate the existing bridge's capacity to carry pedestrian loads, the live load rating factors are summarized in Table 3. The wide flange beam (WF10X25) near the park side can only support 20 percent of the design live load, while the main span crossing BNSF (WF14X34) can support 87% of the design live load.

Because corrosion will continue to reduce the flange thickness, the superstructure beam will reach a buckling limit, defined by  $0.56 \cdot \sqrt{E/F_{yc}}$ , where  $E$  is the steel modulus of elasticity and  $F_{yc}$  is the steel yield stress. The remaining life of the bridge superstructure can be estimated by this buckling limit and the corrosion rate. Table 4 shows steel the corrosion rate under different exposure conditions. While the bridge beams are typically in the atmospheric category, considering that corrosion occurs at the gap between the concrete panel and steel beam, and moisture accumulated inside may change the corrosion rate, it is reasonable to assume the corrosion rate of 0.006 inches per year.

**Table 4 Steel Corrosion Rate (WSDOT BDM Table 6.7-1)**

Location	Marine or Non-Marine: Corrosive	Non-Marine: Non-Corrosive
Soil embedded zone (undisturbed soil)	0.001	0.0005
Soil embedded zone (undisturbed soil)	0.0015	0.00075
Immersed zone	0.003	0.0015
Tidal zone	0.004	-
Splash zone	0.006	-
Atmospheric	0.002	0.001

The estimated life for the WF10X25 beam is 6.5 years, and three years for the WF14X34. One pier steel pipe has a pitted corrosion at the base. Debris and moisture accumulation trapped inside the pipe can

accelerate the deterioration. We recommend a repair to be scheduled immediately. Repair of pipe base can be done by field welding a patch or a sleeve.

## Conclusions

The primary findings from the assessment are deterioration at different connection locations. These locations are not readily accessible for periodic maintenance. Deterioration in steel material includes corrosions at the top flange between the concrete and steel beams, particularly where water can penetrate and accumulate, such as joints and anchor bolts. Deterioration in concrete material includes cracking and spalling.

Our observations of the bridge were based on visual inspection and instrument measurements of effective section thickness, at readily accessible locations. Due to the height of the bridge and active tracks below the bridge, some critical connections between the steel beams and the supporting piers below the deck were not visible.

The structural analysis with reduced sections indicates some deficiencies in the wide flange beam at the parking side approach span, and close to deficiencies at the pipe under the bridge view platform. Both locations have moderate to severe corrosions that may further impact their capacities.

Based on the visibly deteriorated conditions at the structural members and connections, we recommend replacing the bridge within three years, although we have not found an immediate need to close the bridge. The Immediate work for safety includes Pier A-4 pipe base repair and load limitation posting at the parking side entrance.



Figure 12 Existing Bridge Pier Locations

## APPENDIX A.1

# BRIDGE AS-BUILT DRAWINGS





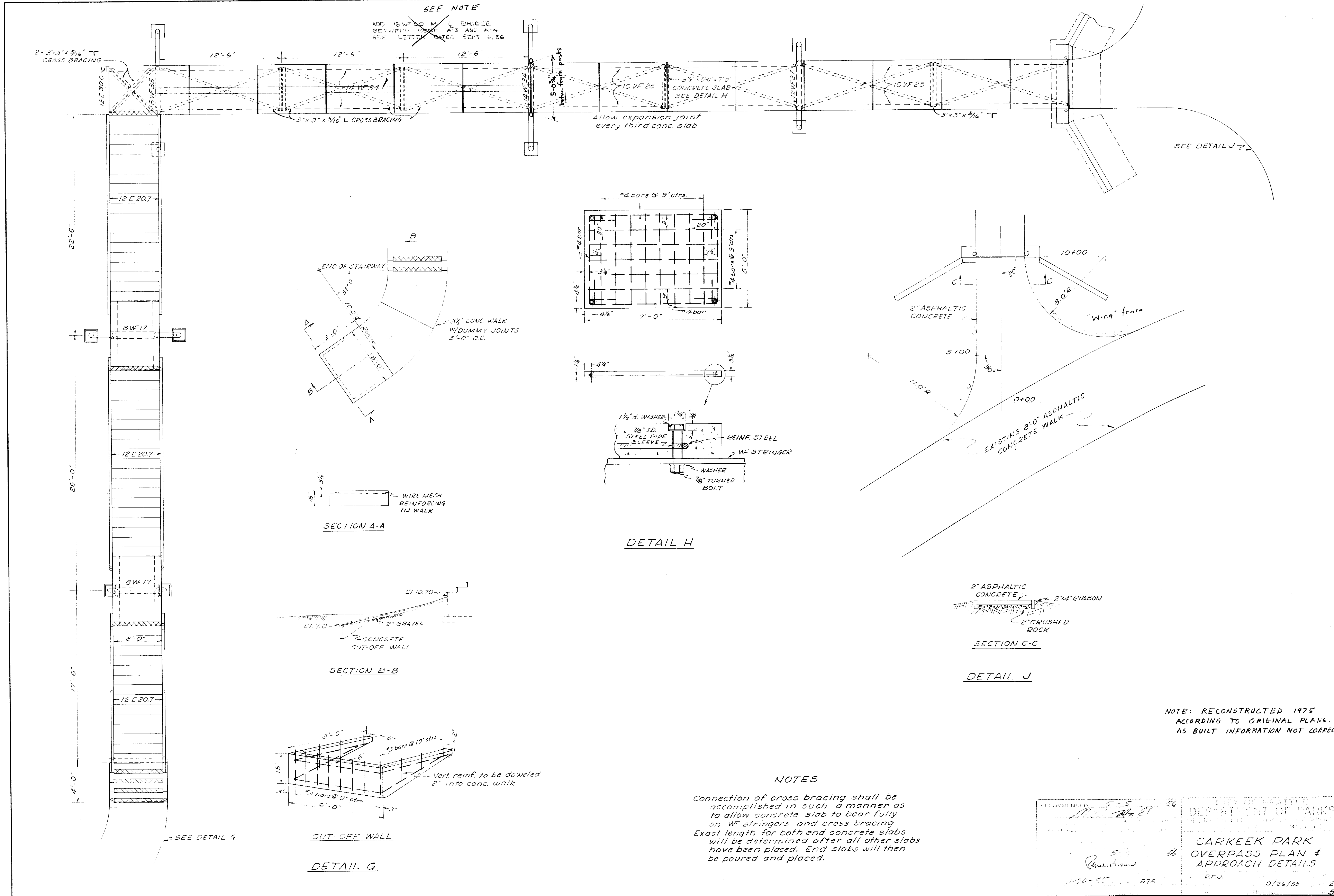

SEE NOTE

ADD 10 WF 25 AT BRIDGE  
BEHIND CONC. AT A3 AND A4  
SEE LETTERS DATE SEPT 2, 56

Allow expansion joint  
every third conc. slab

SEE DETAIL J

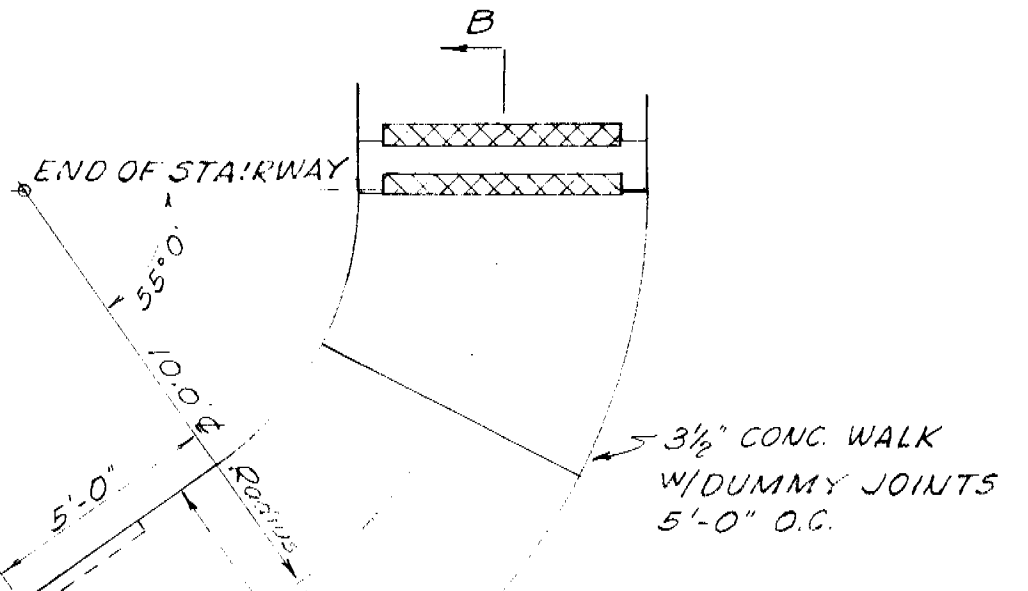

SECTION A-A

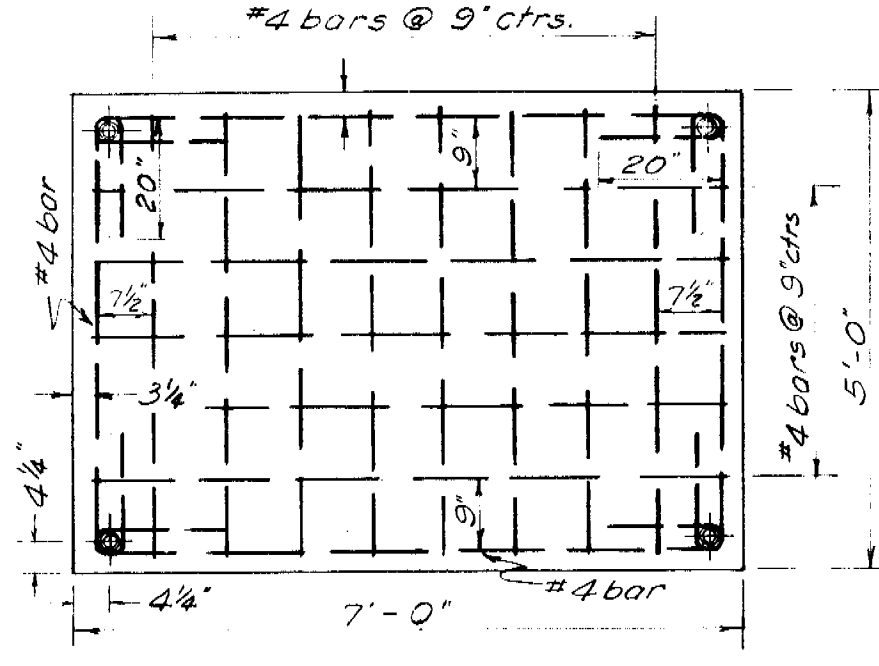

DETAIL H

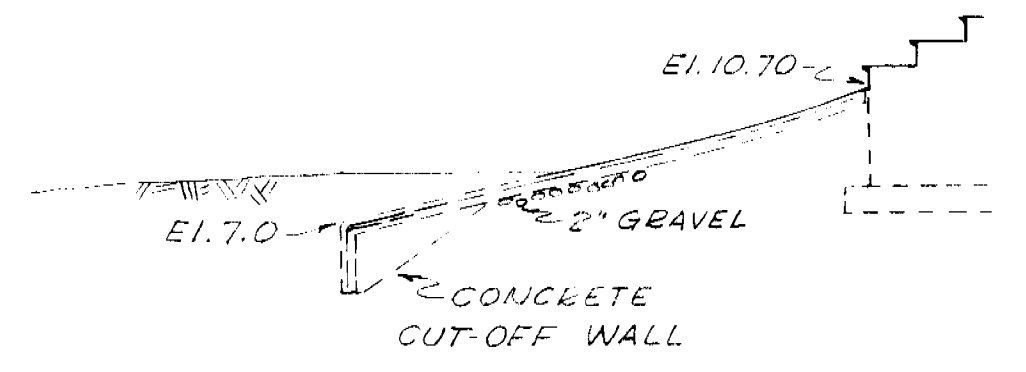
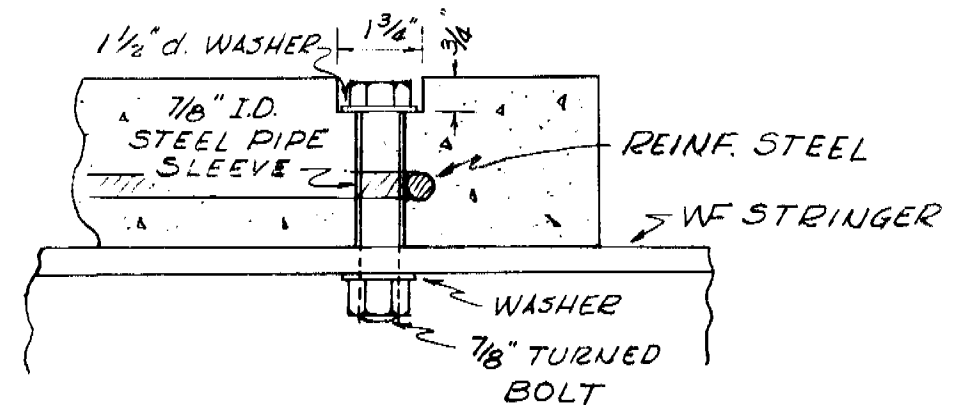

SECTION B-B

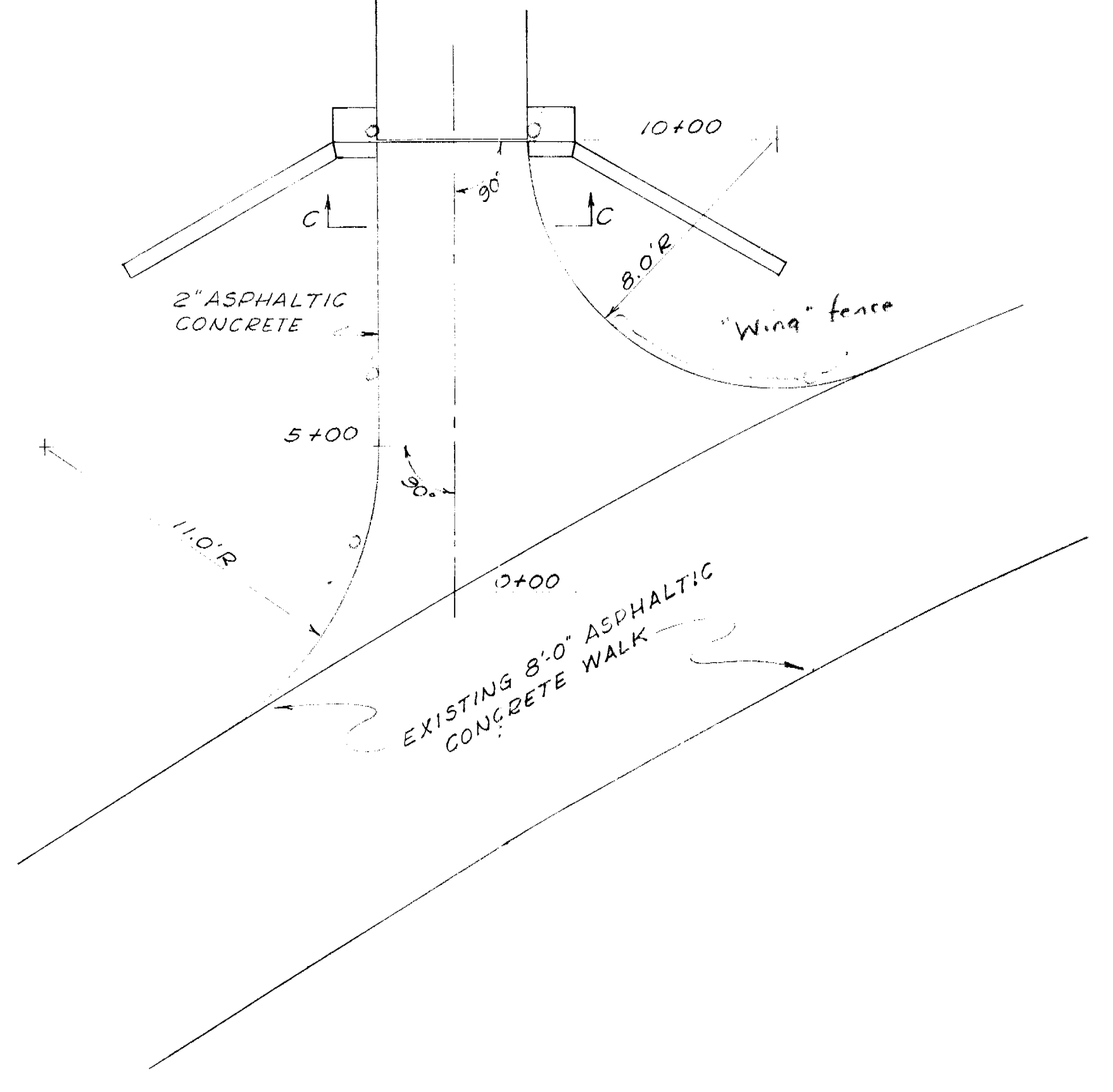

SECTION C-C

DETAIL J

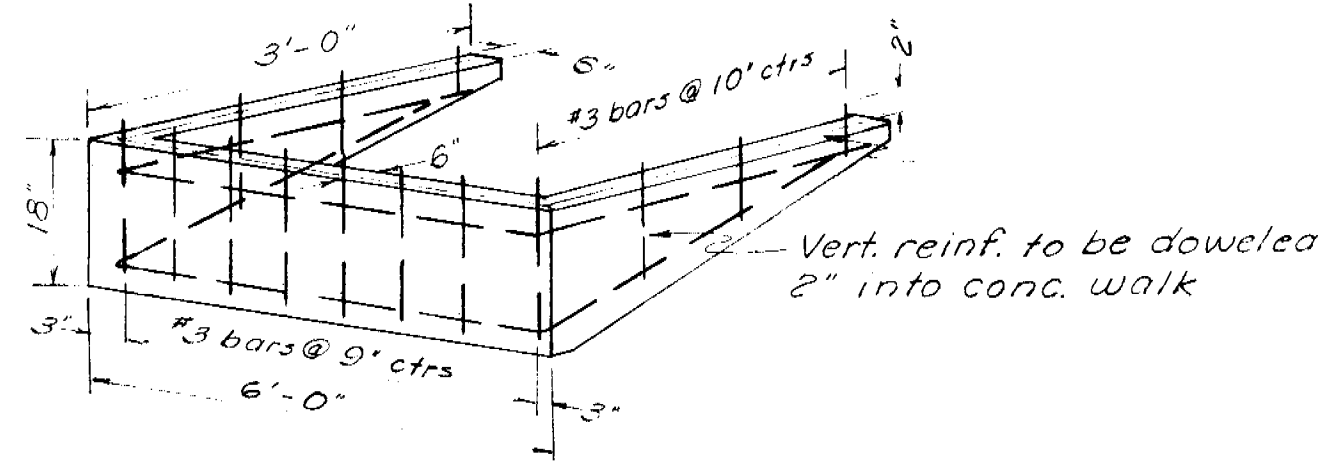

CUT-OFF WALL

DETAIL G

NOTES

Connection of cross bracing shall be accomplished in such a manner as to allow concrete slab to bear fully on WF stringers and cross bracing. Exact length for both end concrete slabs will be determined after all other slabs have been placed. End slabs will then be poured and placed.

NOTE: RECONSTRUCTED 1975  
ACCORDING TO ORIGINAL PLANS.  
AS BUILT INFORMATION NOT CORRECT.

5-5 575 9/26/55	CITY OF SEATTLE DEPARTMENT OF PARKS CARKEEK PARK OVERPASS PLAN & APPROACH DETAILS 9/26/55
-----------------------	--



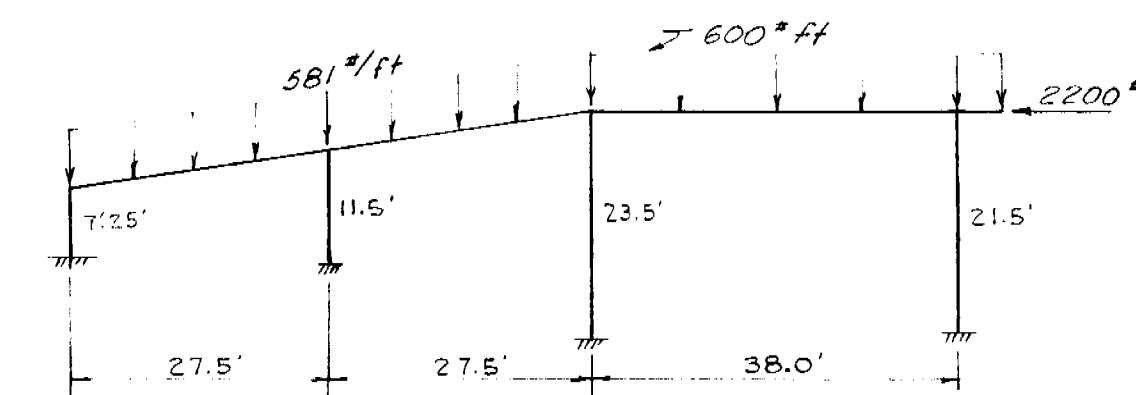
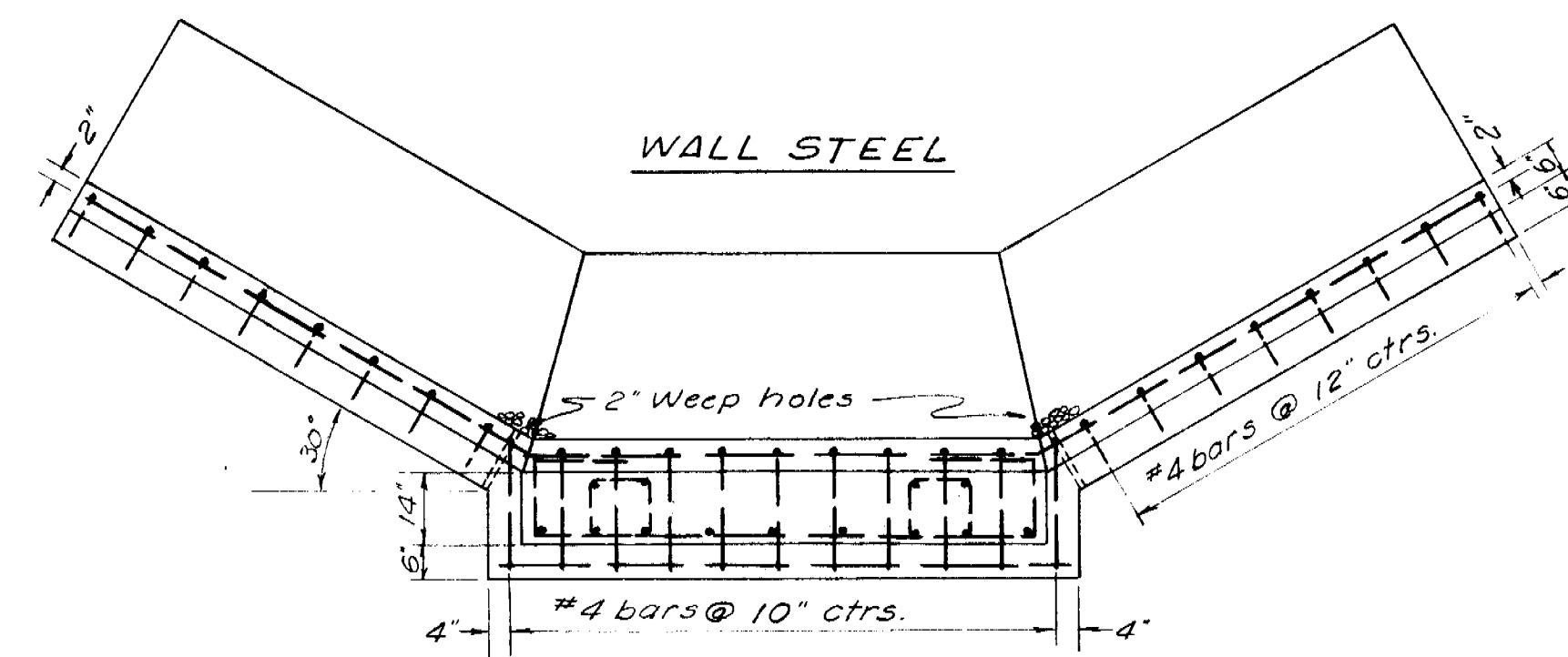
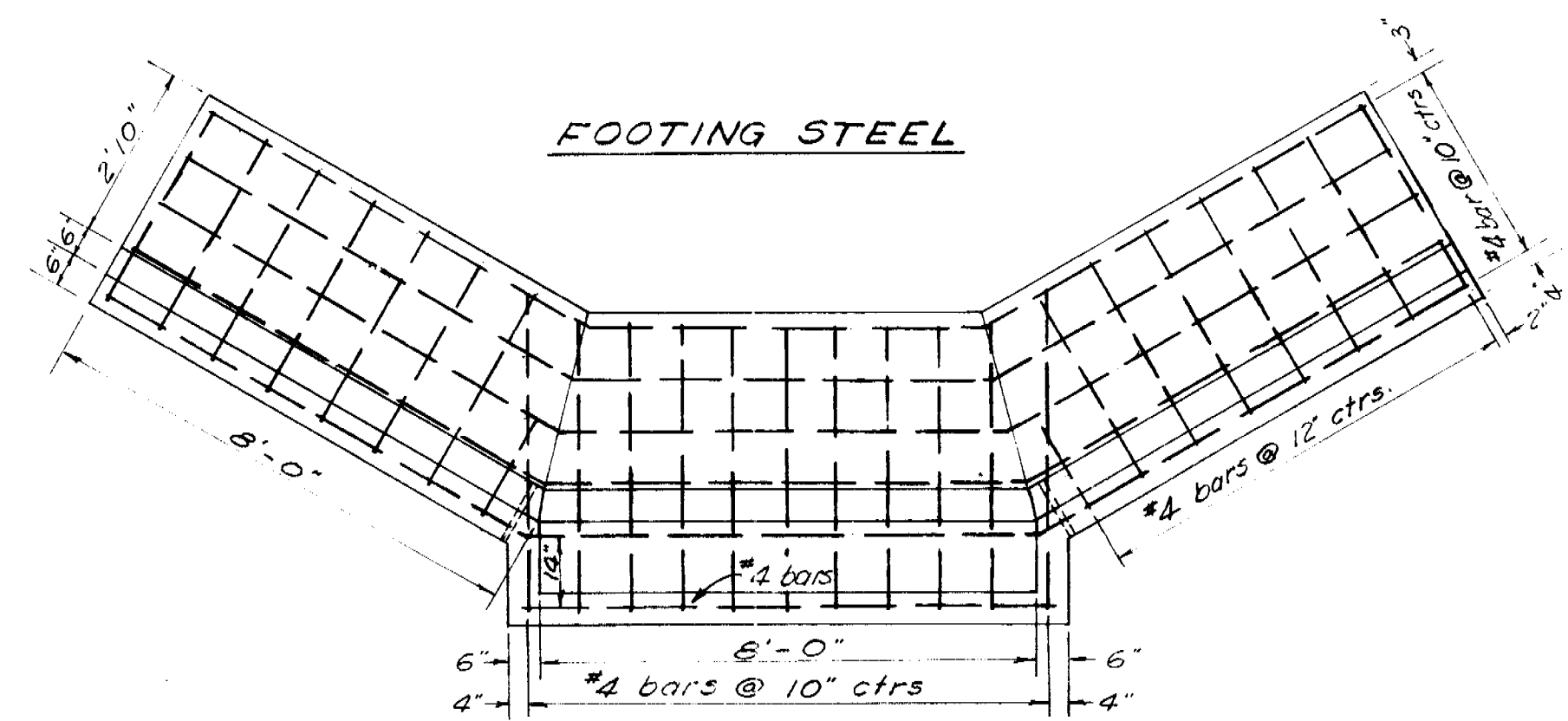

LOAD DIAGRAM

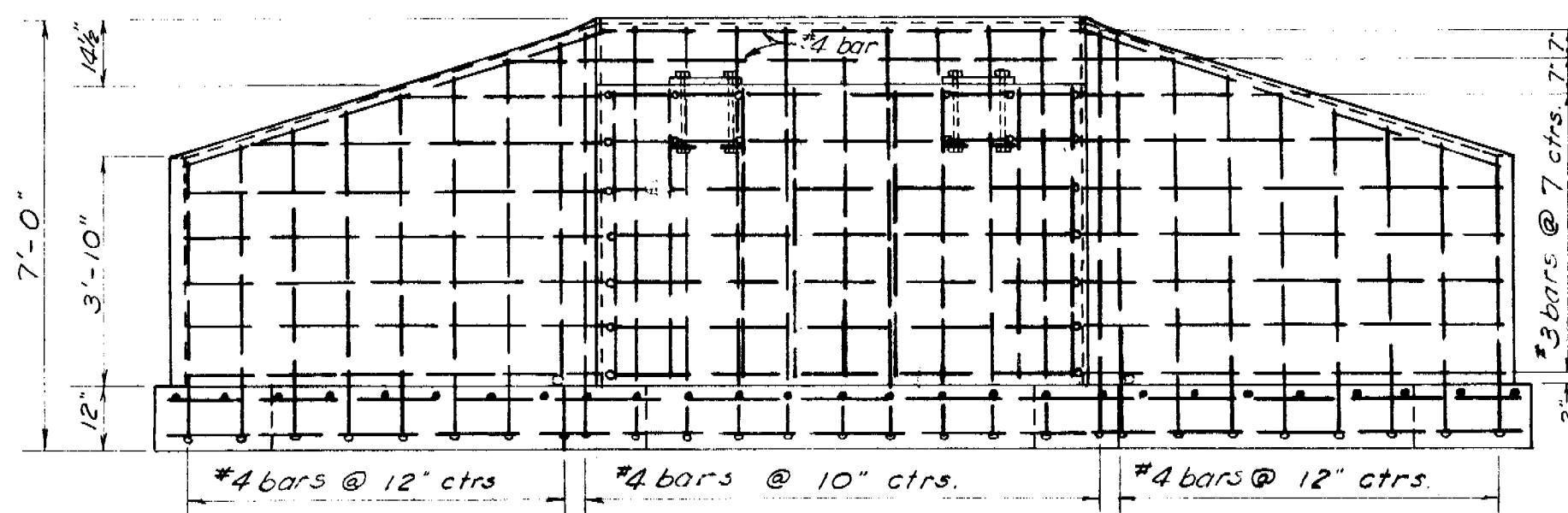

ELEVATION

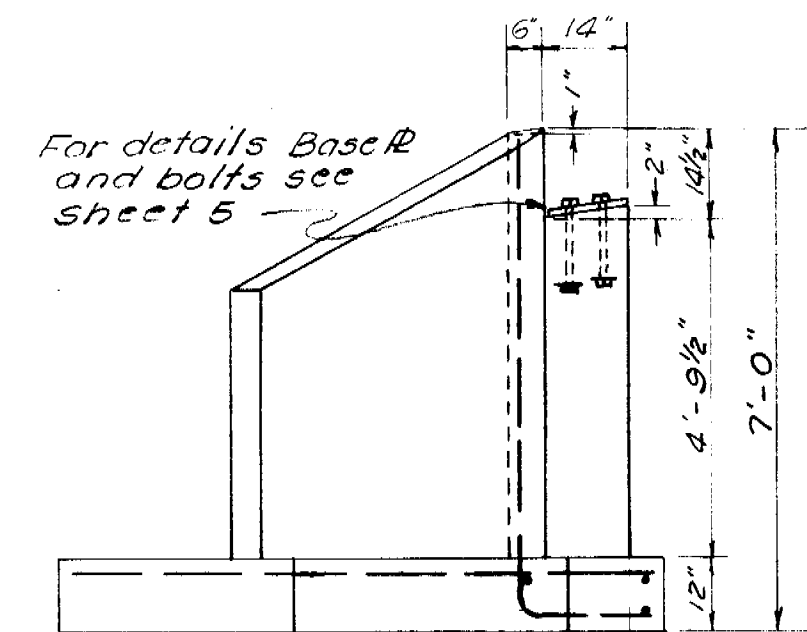

DETAIL A

NOTES  
All reinforcing steel to be placed 2" from face of concrete unless otherwise specified.  
Lap all bars 40 diameters.

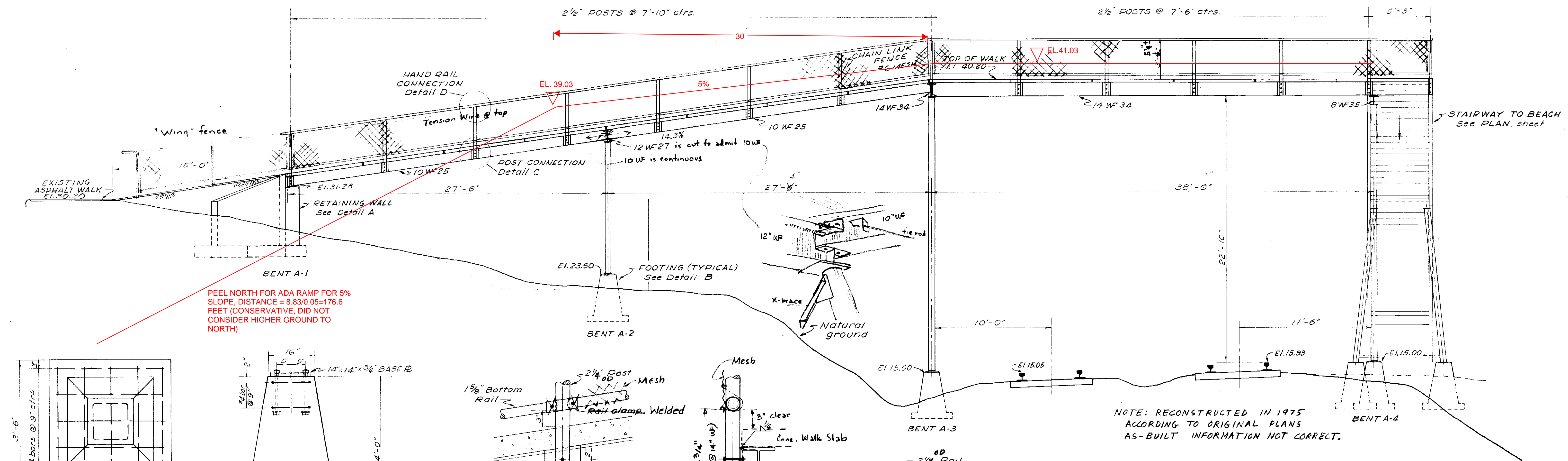

NOTE: RECONSTRUCTED IN 1975 ACCORDING TO ORIGINAL PLANS AS-BUILT INFORMATION NOT CORRECT.

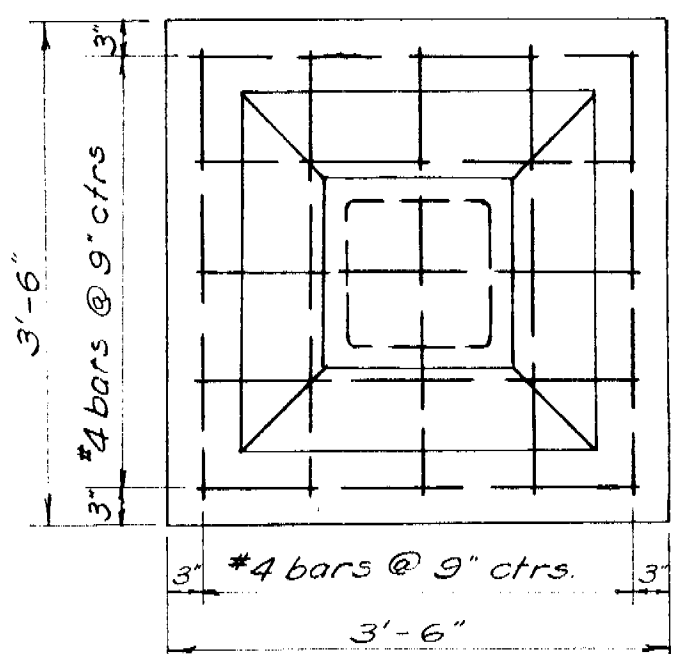

DETAIL B

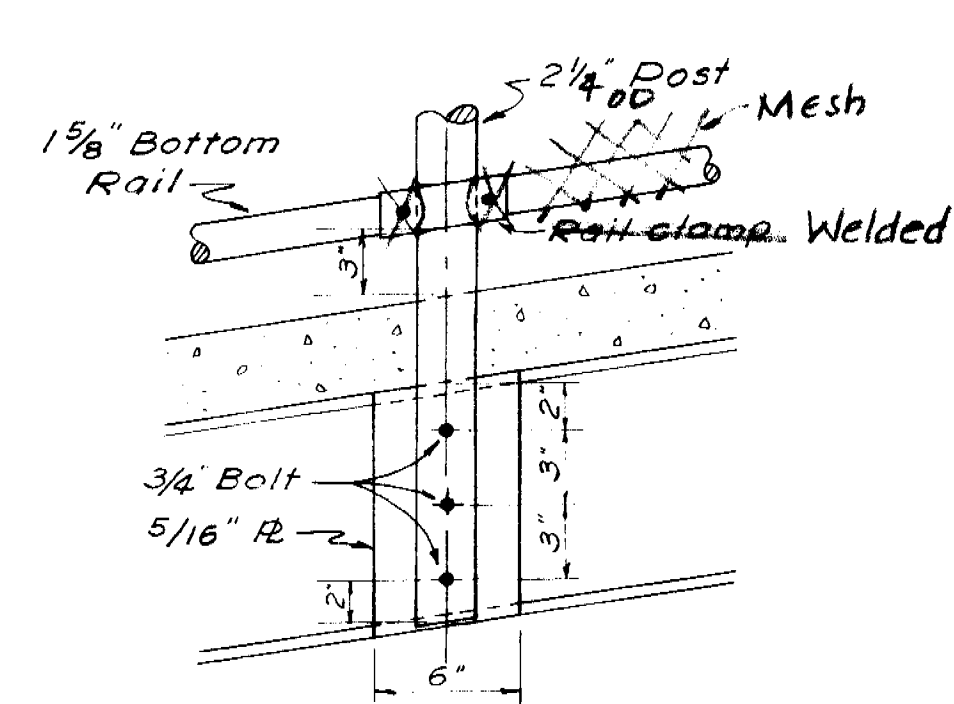
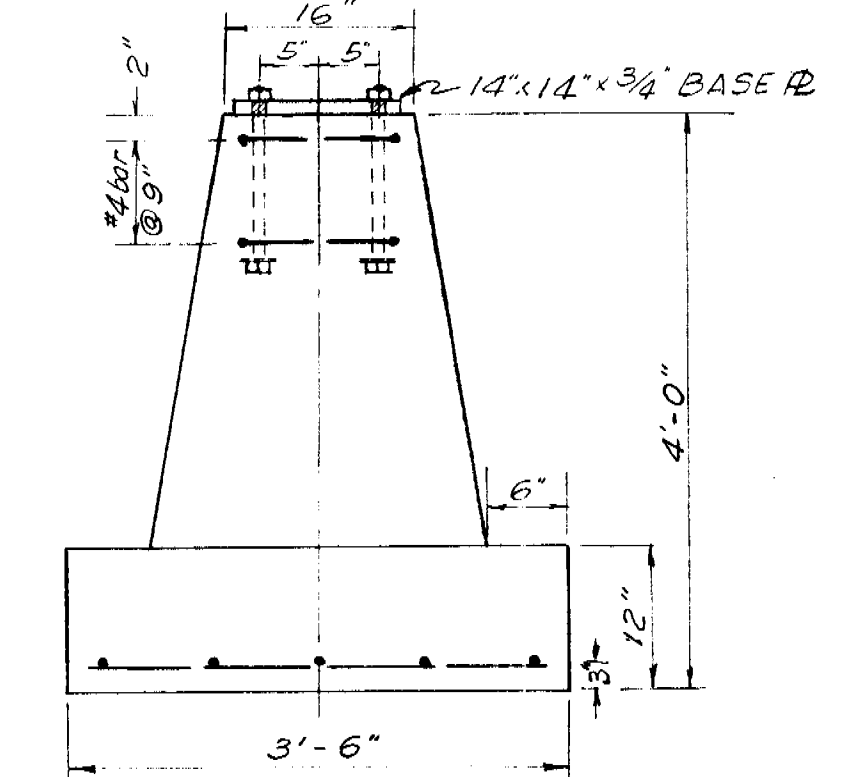

DETAIL C

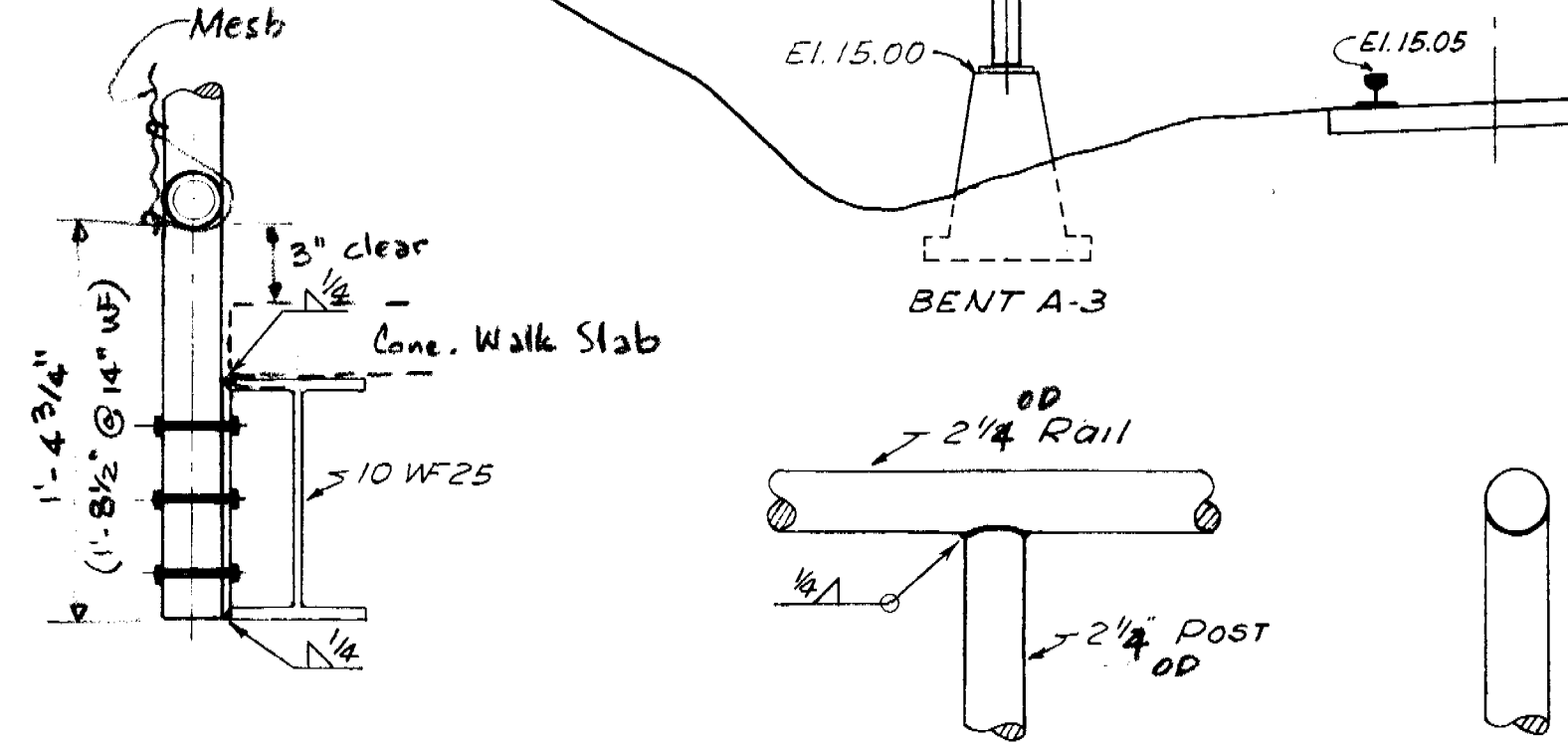

DETAIL D

PREPARED BY  DATE 5-5-56 1-22-55	CITY OF SEATTLE DEPARTMENT OF PARKS 100 PLYMOUTH AVENUE SEATTLE, WASH. 98104 <b>CARKEEK PARK          OVERPASS SECTION          DETAILS</b> SHEET NO. 3 SCALE 1/4" = 1'-0"
--	--

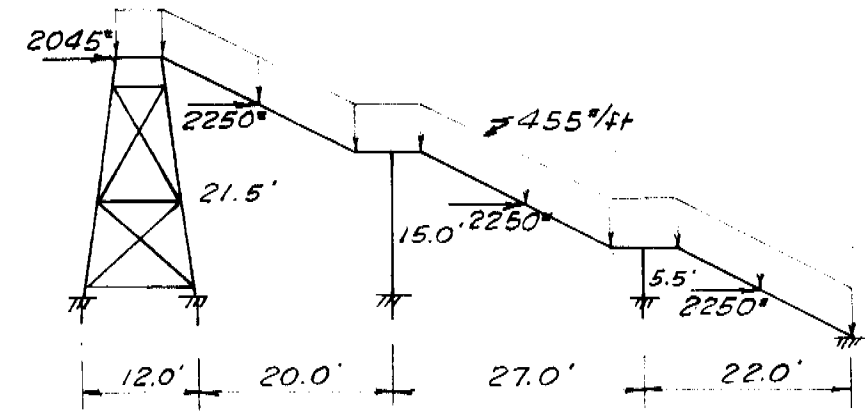

LOAD DIAGRAM

FOOTING HEIGHT		
BENT NO.	L	R
A-4	5'-0"	5'-0"
B-1	8'-0"	5'-0"
B-2	6'-6"	4'-6"

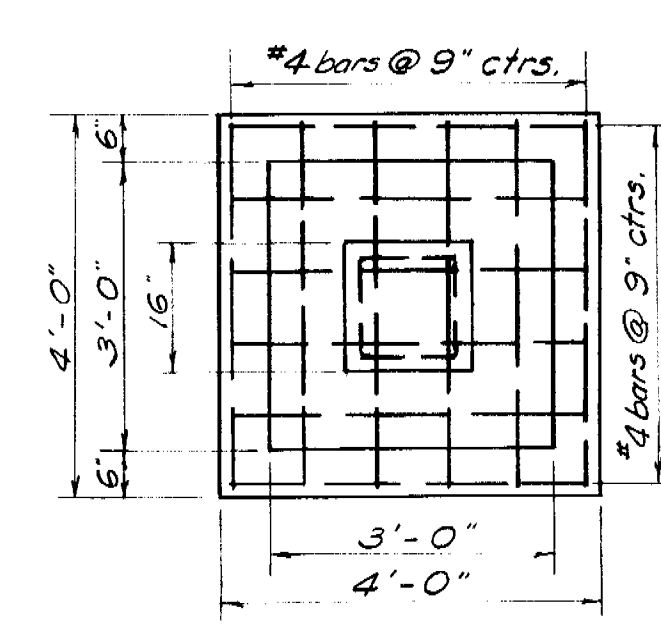
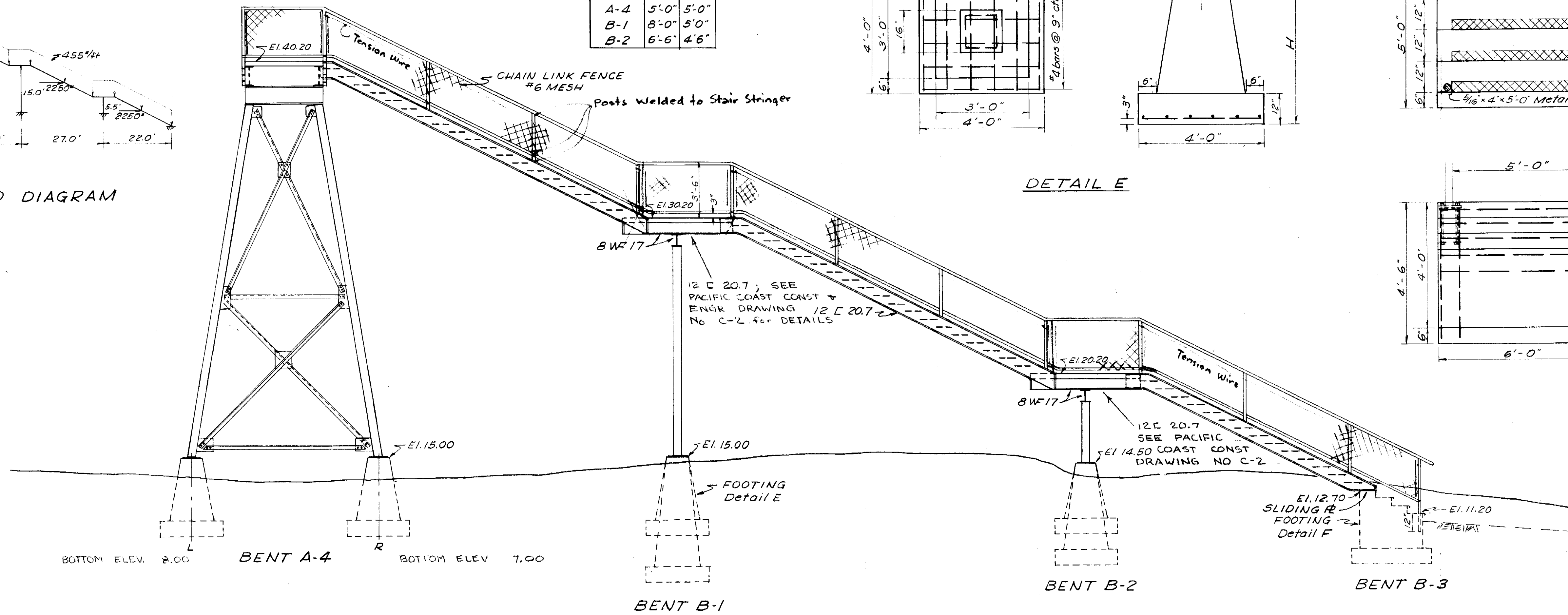

DETAIL E

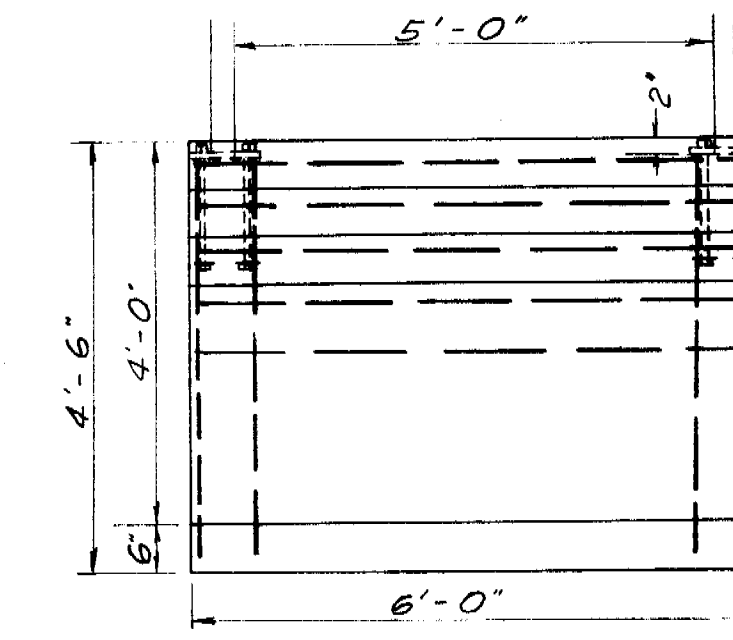
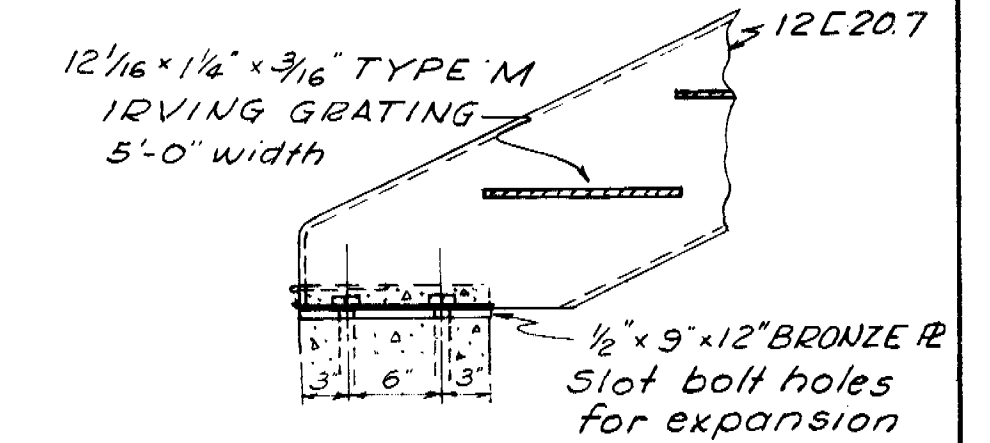
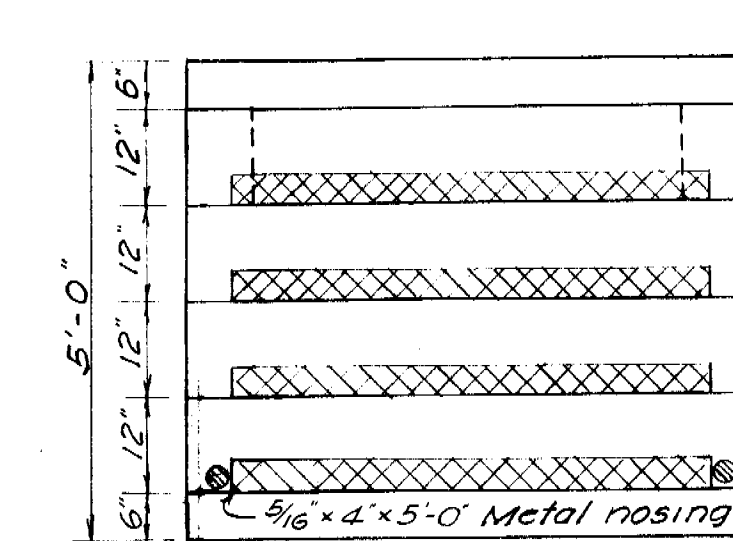
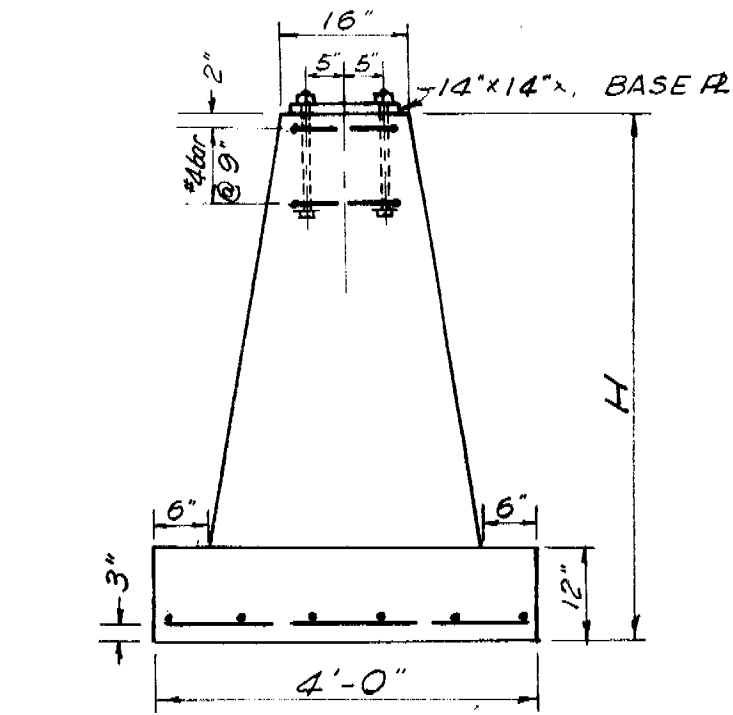

DETAIL F

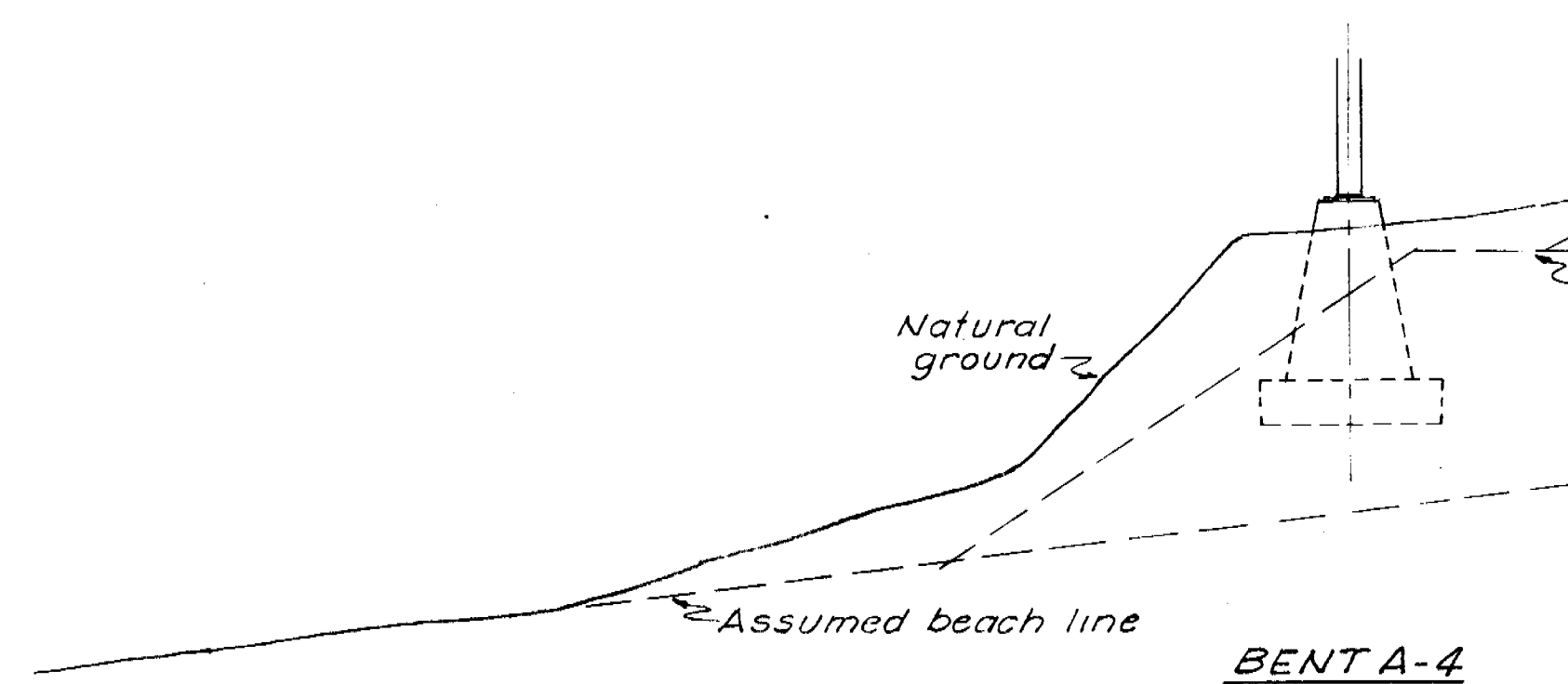
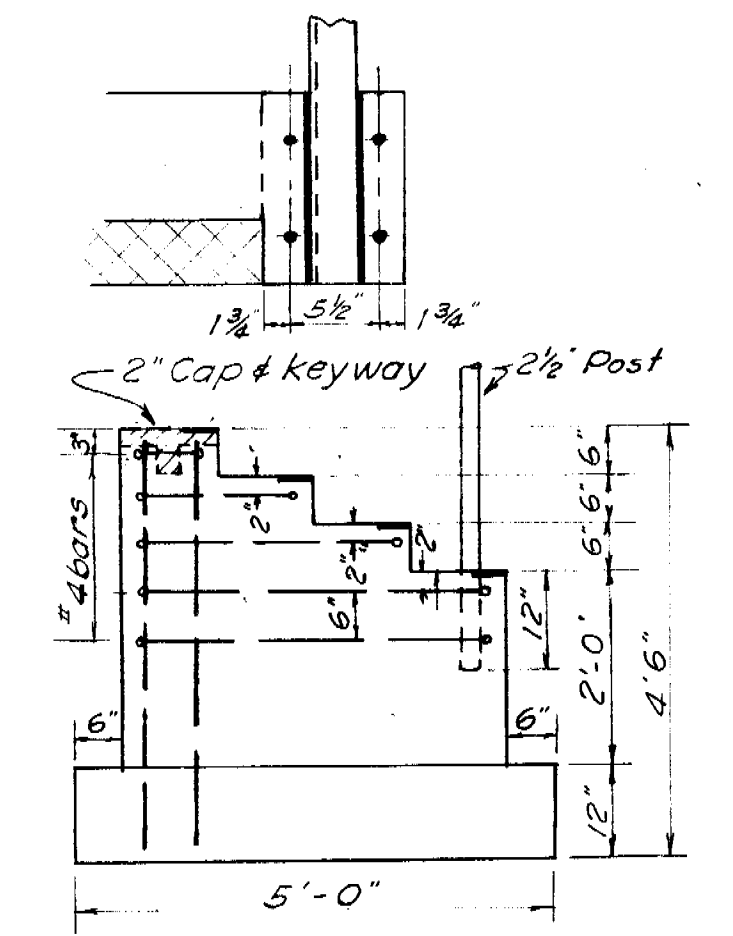

BENT A-4

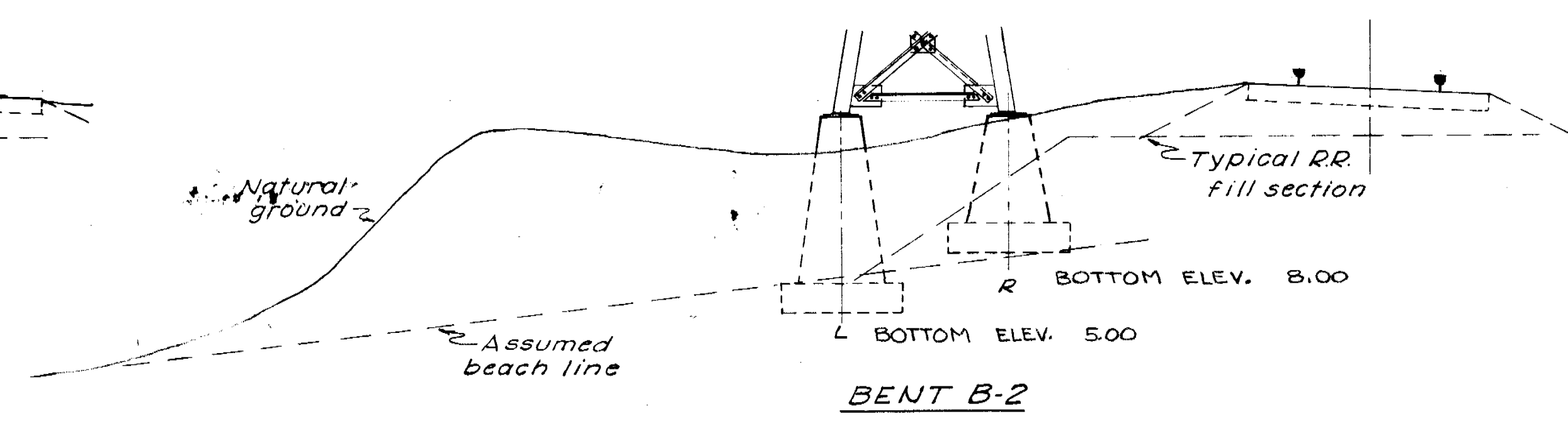

BENT B-2

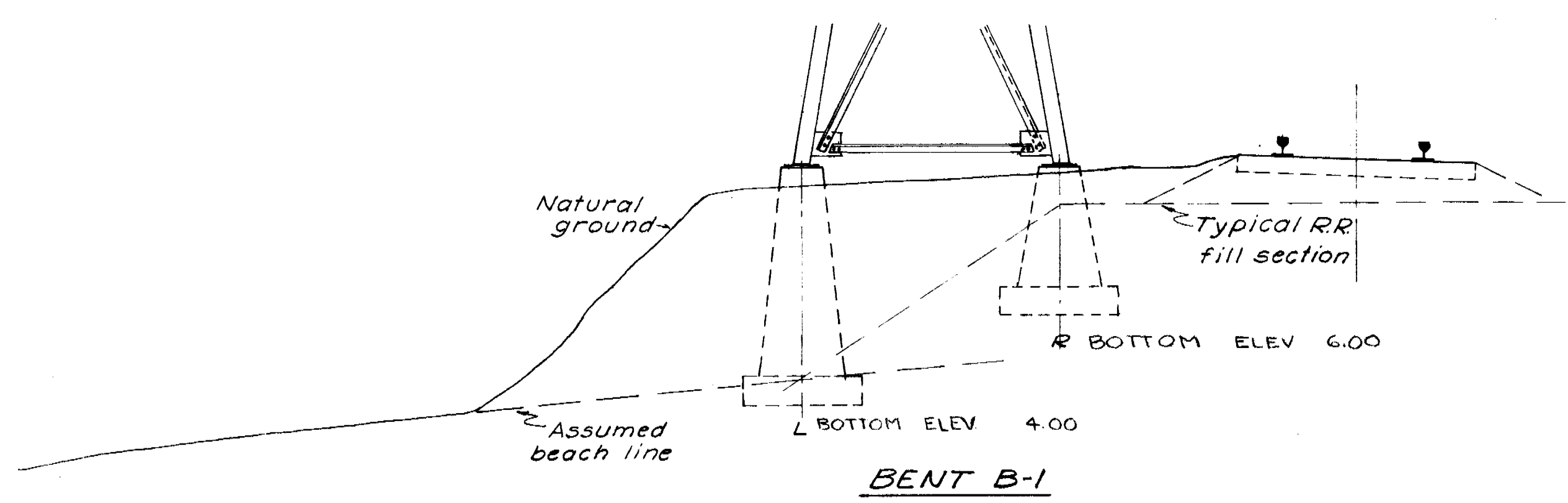

BENT B-1

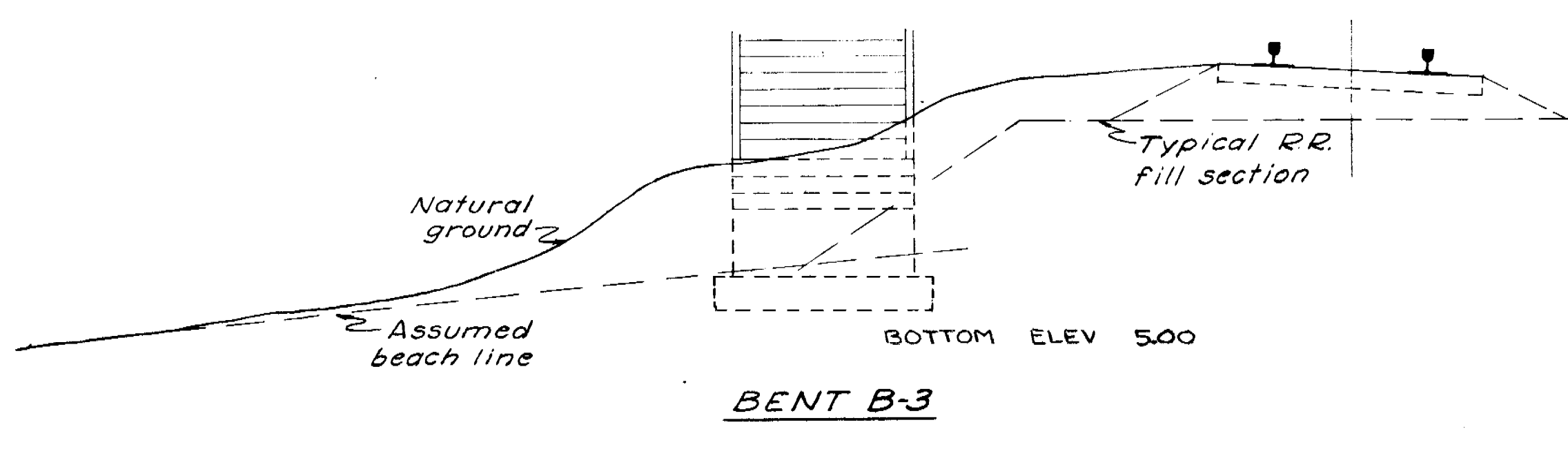

BENT B-3

CROSS-SECTIONS

NOTES  
 2" cap and keyway to be poured after stairway stringer has been secured to footing, giving riser depth of 6".

NOTE: RECONSTRUCTED IN 1975 ACCORDING TO ORIGINAL PLANS. AS-BUILT INFORMATION NOT CORRECT.

5-5 Hall	11-53	CITY OF SEATTLE DEPARTMENT OF PARKS DESIGN & CONSTRUCTION DIVISION 1000 1ST AVE. S.E. MA 1000
5-5 Bauer	56	
1-20-55	575	CARKEEK PARK STAIRWAY SECTION DETAILS BEI 9/26/55 4 5

07424



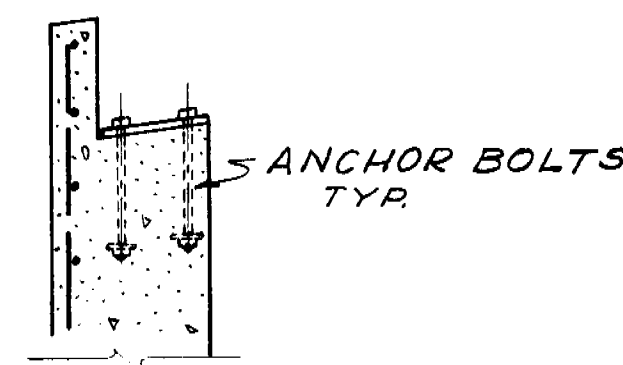

SECTION A-A

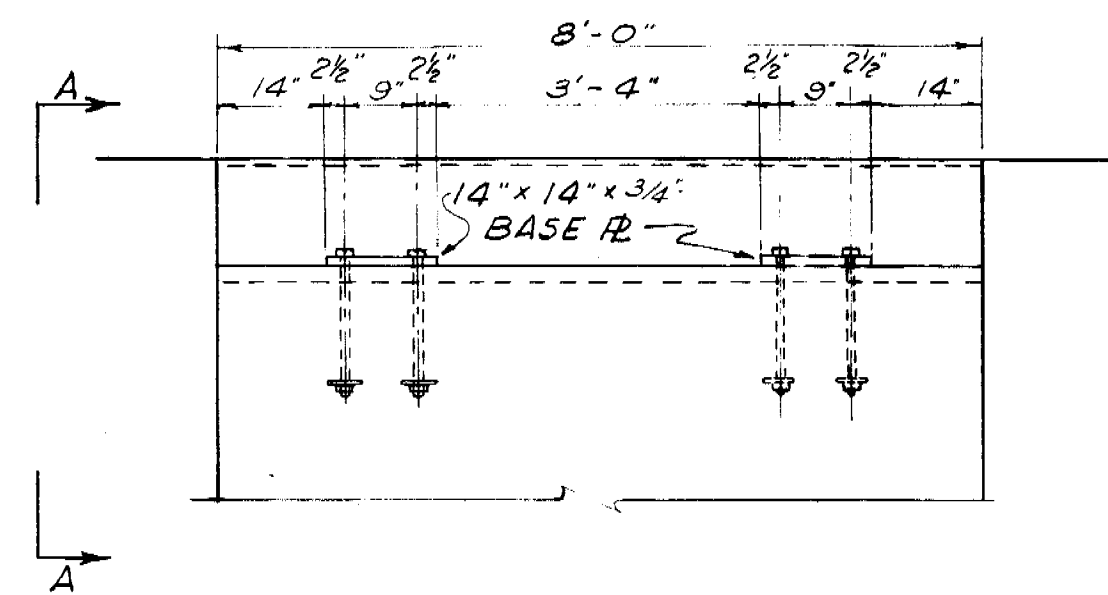

BENT DETAIL A-1

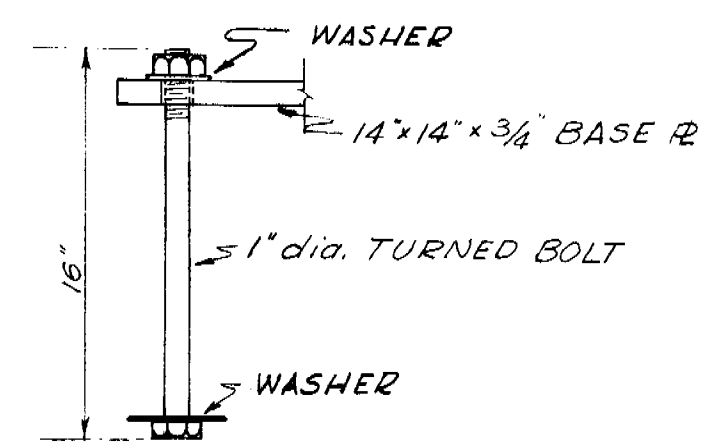

ANCHOR BOLT DETAIL

Angle cap at 14.3% on BENT A-2 only

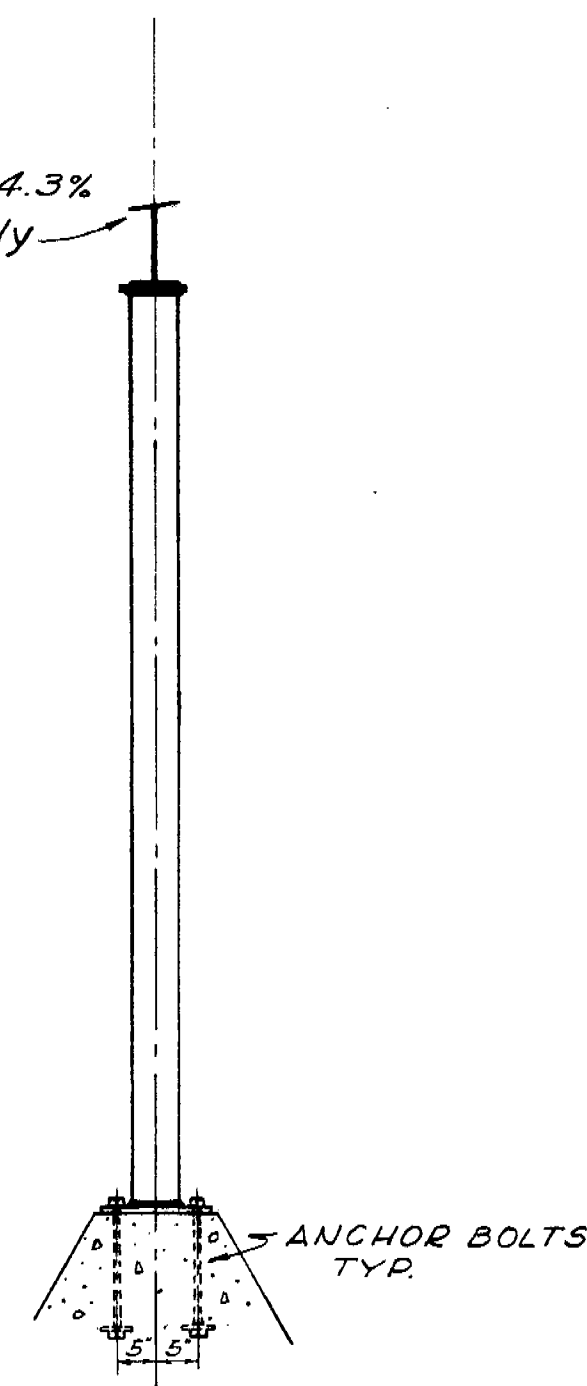

SECTION B-B

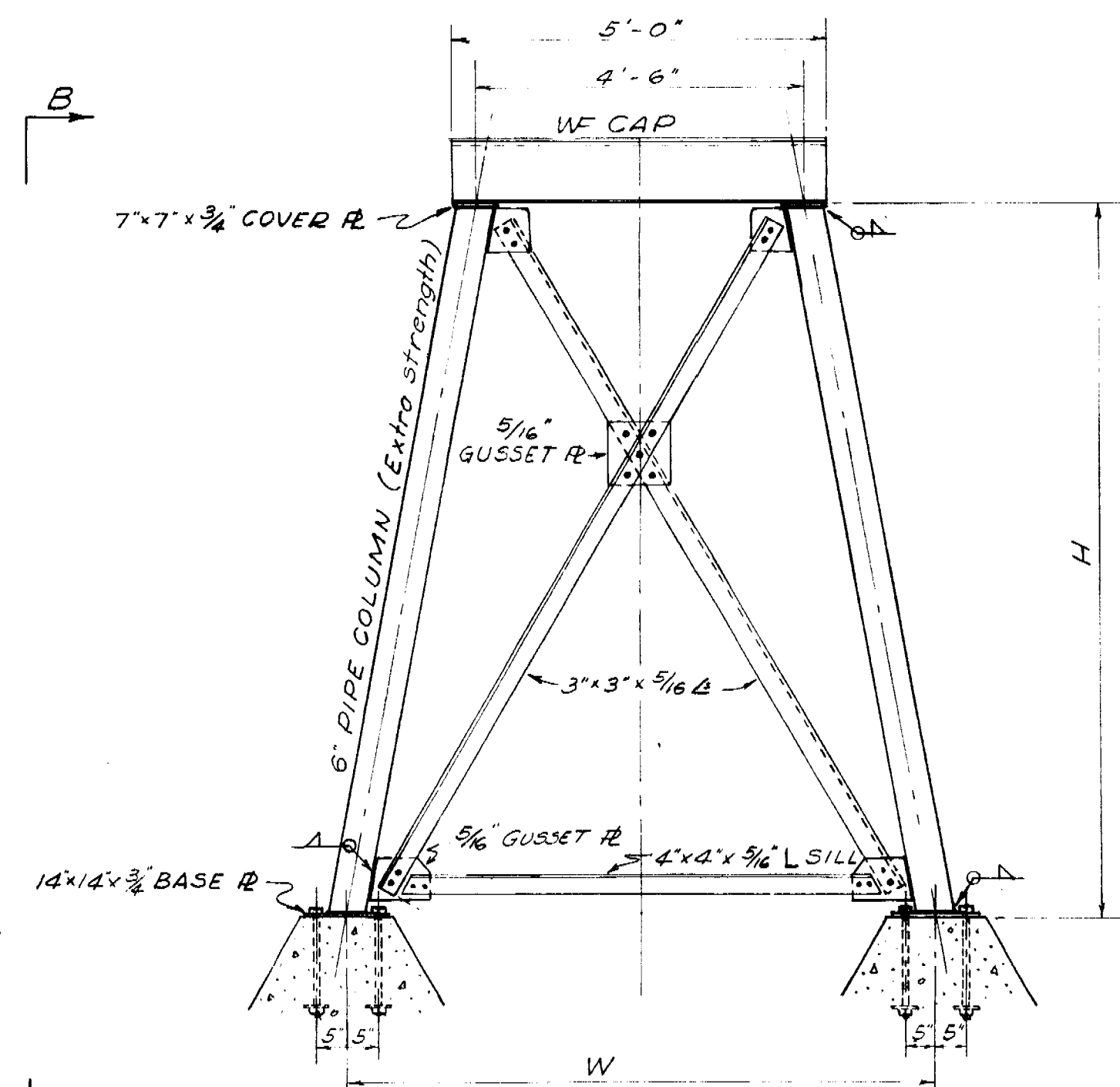

BENT DETAILS A-2, B-3, B-4

BENT NO.	DIMENSIONS			NOMINAL LENGTH		
	W	H	h	6" COLUMN	DIAGONALS	SILL
A-2	8'-4"	11'-4 1/2"	-	11'-6 1/2"	12'-5"	7'-8"
B-1	9'-0"	13'-6 1/2"	-	13'-9"	14'-4"	8'-4"
B-2	5'-6"	3'-1"	-	3'-3 3/4"	5'-3"	4'-10"

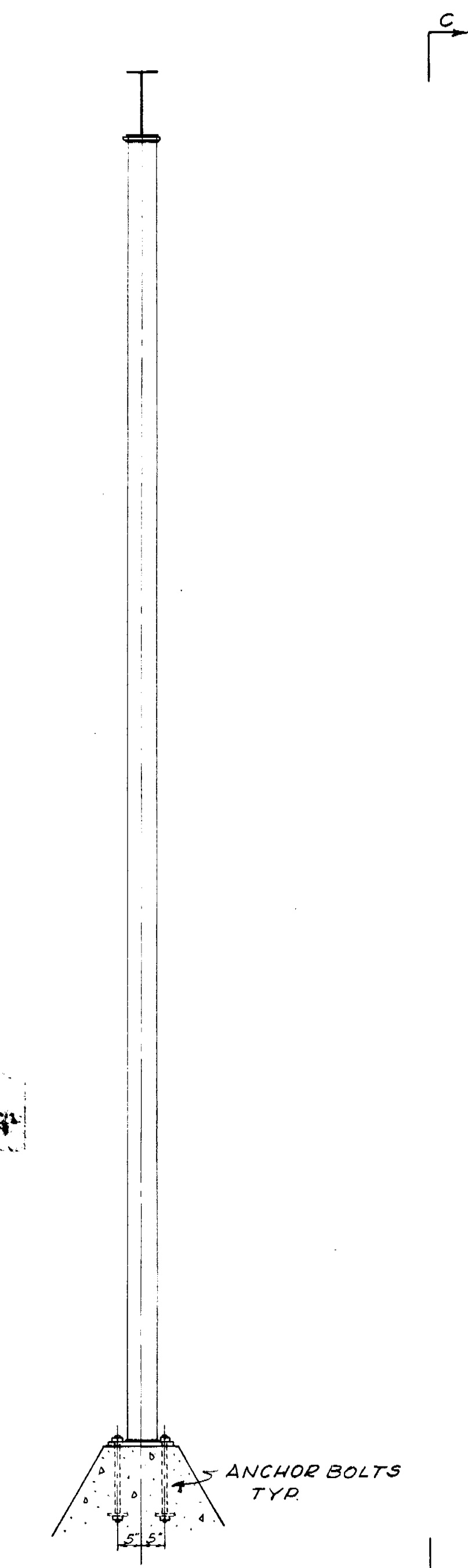

SECTION C-C

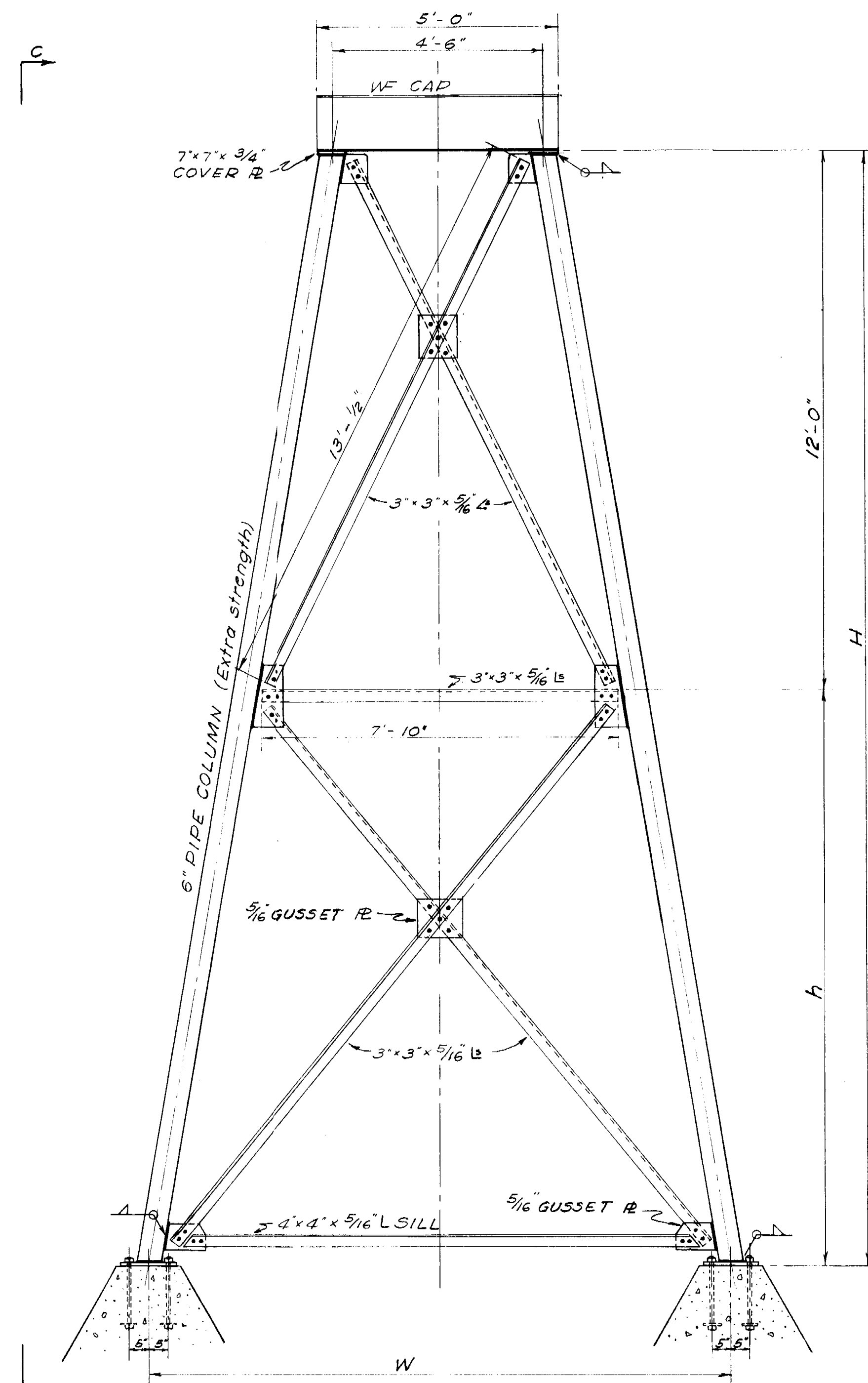

BENT DETAIL A-3, A-4

NOTES

Contractor shall design all connections required for fabrication of structure and such connections shall conform with City of Seattle, Washington Building Code.  
For size of WF CAPS see sheets 3 and 4.

NOTE: RECONSTRUCTED IN 1975.

BENT NO.	DIMENSIONS			NOMINAL LENGTH		
	W	H	h	6" COLUMN	DIAGONALS	SILL
A-3	12'-6"	23'-9"	11'-9"	24'-1"	14'-11"	11'-6"
A-4	12'-2"	23'-1"	11'-4 1/2"	23'-4 1/2"	14'-7"	11'-4"

RECOMMENDED <i>RC 7/20</i>	1954	CITY OF SEATTLE DEPARTMENT OF PARKS DESIGN & CONSTRUCTION DIVISION 100 DEXTER AVE. MA. 6000
CONCURRED		CARKEEK PARK BENT DETAILS FOR OVERPASS SECTION
APPROVED <i>Sumner</i>	5-5 1956	SCALE
AUTHORIZED 1-20-55	575	FILE NO. 9/26/55
STARTED	COMPLETED	NO. 5 OF 5

07425



## APPENDIX A.2

# BRIDGE INSPECTION REPORTS

**BRIDGE INSPECTION REPORT**

Status: Released

Printed On: 10/6/2017

Agency: City/Other Park, Forest, or Reservation Agency

CD Guid: dd7cc383-0312-421c-bb55-8a177d457d03

CD Date: 7/24/2017

Program Mgr: Roman G. Peralta

**Br. No.** BRG-079

**SID** 08567700

**Br. Name** CARKEEK PARK PED /RR

**Carrying** PEDESTRIAN

**Route On**

**Mile Post**

**Intersecting** NPPR

**Route Under**

**Mile Post**

Inspector's Signature KL

Cert # G0520

Cert Exp Date 5/11/2022

Co-Inspector's Signature CEH

<input type="checkbox"/>	Structural Eval (1657)	0	<input type="checkbox"/>	Operating Tons (1552)	0	<input type="checkbox"/>	No Utilities (2675)	<b>Inspections Performed:</b>				
9	<input type="checkbox"/>	Deck Geometry (1658)	<input type="checkbox"/>	Op RF (1553)	N	<input type="checkbox"/>	Bridge Rails (1684)	<b>Freq</b>	<b>Hrs</b>	<b>Date</b>	<b>Rep Type</b>	
4	<input type="checkbox"/>	Underclearance (1659)	0	<input type="checkbox"/>	Inventory Tons (1555)	N	<input type="checkbox"/>	Transition (1685)	24	1.0	5/13/2015	Routine
9	<input type="checkbox"/>	Alignment (1661)	<input type="checkbox"/>	Inv RF (1556)	N	<input type="checkbox"/>	Guardrails (1686)				Fract Crit	
5	<input type="checkbox"/>	Deck Overall (1663)	<input type="checkbox"/>	Operating Level (1660)	N	<input type="checkbox"/>	Terminals (1687)				UW	
7	<input type="checkbox"/>	Superstructure (1671)	<input type="checkbox"/>	Open/Closed (1293)	0.00	<input type="checkbox"/>	Asphalt Depth (2610)				Special	
6	<input type="checkbox"/>	Substructure (1676)	9	<input type="checkbox"/>	Waterway (1662)	<input type="checkbox"/>	Design Curb Ht (2611)	24	1.0	6/9/2016	Interim	
9	<input type="checkbox"/>	Culvert (1678)	N	<input type="checkbox"/>	Scour (1680)	<input type="checkbox"/>	Bridge Rail Ht (2612)				UWI	
9	<input type="checkbox"/>	Chan/Protection (1677)				1956	Year Built (1332)				Damage	
N	<input type="checkbox"/>	Pier/Abut/Prot (1679)				1975	Year Rebuilt (1336)	12	1.0	5/26/2017	Safety	
<input type="checkbox"/>	Soundings Flag (2693)	<input type="checkbox"/>	Revise Rating (2688)	<input type="checkbox"/>	Photos Flag (2691)	<b>Sufficiency Rating</b>					Short Span	
<input type="checkbox"/>	Measure Clrc (2694)	<input type="checkbox"/>	QA Flag (2695)	<b>No Risk Category</b>							In Depth	
											Geometric	

**BMS Elements**

Element	Element Description	Total	Units	CS 1	CS 2	CS 3	CS 4
12	Concrete Deck	545	SF	241	4	300	0
90	Steel Rolled Girder	238	LF	236	0	2	0
202	Steel Pile/Column	10	EA	5	0	5	0
215	Concrete Abutment	15	LF	15	0	0	0
221	Concrete Foundation	5	EA	5	0	0	0
231	Steel Pier Cap/Crossbeam	35	LF	35	0	0	0
260	Steel Sidewalk & Supports - Open Grid	600	SF	600	0	0	0
340	Metal Pedestrian Railing	198	LF	198	0	0	0
904	Organic Zinc/Urethane Paint System	12,000	SF	12,000	0	0	0

**Notes**

--

**BRIDGE INSPECTION REPORT**

Status: Released

Printed On: 10/6/2017

Agency: City/Other Park, Forest, or Reservation Agency

CD Guid: dd7cc383-0312-421c-bb55-8a177d457d03

CD Date: 7/24/2017

Program Mgr: Roman G. Peralta

<b>Br. No.</b> BRG-079	<b>SID</b> 08567700	<b>Br. Name</b> CARKEEK PARK PED /RR	
<b>Carrying</b> PEDESTRIAN		<b>Route On</b>	<b>Mile Post</b>
<b>Intersecting</b> NPRR		<b>Route Under</b>	<b>Mile Post</b>

**Notes (Continued)**

0 7/24/2017 - added repair recommendation for BE 090, Steel Rolled Girder, west stair landing, 1" X 2" rusted web section loss.

05/26/17, Safety Inspection, KL/CEH, 1 P.M., 73°F., Sunny.

Orientation

\* BRG-079 spans west to east crossing-over R/R tracks. The west end is near Puget Sound. The east end is near the parking lot.

\* For this report: Structure components moving west to east:  
Starting parallel to R/R tracks heading north: W. Abut, ST1, P1, ST2, P2, ST3, P3, turning 90 degrees east over R/R tracks, SS1, P4, SS2, P5, SS3, and E. Abut at Carkeek parking lot.

ST= stairways. SS = superstructure spans. P = steel A-frame post piers.

Seattle Parks is bridge owner.

\* TW66864/F49

3 General Notes

\* Portions of bridge painted in 2009 except for the bents and spans over the R/R tracks.

\* Verify SQ of open grid

\* Fence fabric replaced with a green, vinyl coated fabric.

12 Concrete Deck

\* Deck panels east of main span - hairline cracks along top and soffit surfaces - Continue to Observe (CTO).

\* Typical along soffit surfaces - spalls w/exposed rebar and hairline cracking with rust stains - CTO.

\* Panels connections to structural beam are secured to steel girders via weld tabs. In some cases weld tabs have broken.

\* Top of east approach deck panels have been ground down in 2 locations to achieve smooth transition between panels.

\* Main span - transverse hairline cracks along middle of precast panel typical - CTO.

**BRIDGE INSPECTION REPORT**

Status: Released  
 CD Guid: dd7cc383-0312-421c-bb55-8a177d457d03

Printed On: 10/6/2017  
 CD Date: 7/24/2017

Agency: City/Other Park, Forest, or Reservation Agency  
 Program Mgr: Roman G. Peralta

<b>Br. No.</b> BRG-079	<b>SID</b> 08567700	<b>Br. Name</b> CARKEEK PARK PED /RR	
<b>Carrying</b> PEDESTRIAN		<b>Route On</b>	<b>Mile Post</b>
<b>Intersecting</b> NPRR		<b>Route Under</b>	<b>Mile Post</b>

**Notes (Continued)**

90 Steel Rolled Girder

- \* E-end: girder connections to E-abutment concrete seat are covered in organic debris - Recommendation: remove debris to limit corrosive environment.
- \* E-end: girder flange interior surfaces are corroding - CTO.
- \* Span over R/R tracks: girder corrosion - Recommendation: paint following manufacturers' surface prep requirements.
- \* South side, bottom flange is bent at 2 locations: above the west track and near the west abutment - CTO.
- \* Span above R/R tracks: tension rods appear loose - CTO.
- \* Tension rods above R/R tracks: paint worn down to either the galvanized finish or to bare, metal substrate. From a distance, could not confirm corrosion - CTO.
- \* Below deck cross-bracing L-sections are corroding with visible section loss - Recommend - paint following manufacturers' surface prep requirements.
- \* Steel diaphragms top of piers - corrosion along flange edges and at bolted connections - Recommend - spot paint following manufacturers' surface prep recommendations.
- \* At the west stair, about 1" x 2" rusted web section loss near top of east steel channel beam of stairway - Recommendation: repair to remove the wobble in the landing.
- \* C-section beams supporting stairway landings - failed protective coatings along hard to reach interior areas - Recommendation - paint following manufacturers' surface prep requirements.

202 Steel Pile/Column

- \* Steel post columns adjacent to RR tracks show moderate corrosion. Recommendation - paint following manufacturer's surface prep recommendations.
- \* Pier posts lateral bracings - failing protective coatings - typical - CTO.
- \* Pier 3 post to concrete pedestal connections, immediately west of R/R tracks - protective coating worn away from the two base plates. Pitted corrosion along post to plate interfaces. Recommendation - paint bolted connection plates following manufacturer's surface prep recommendations.
- \* Pier 4 post to concrete pedestal connections - immediately east of tracks - connections covered with R/R ballast

215 Abutment

East abutment: See Steel Rolled Girder at east abutment connection concerning debris on top of anchor bolt connections.

221 Concrete Foundation

- \* Post connections to concrete pedestals are covered with debris at Piers 1, 2, and 4. Recommendation: remove debris to reduce corrosive environment and assist in visual inspections of these connections. If protective coatings are worn away, paint following the manufacturer's surface prep requirements.

231 Steel Caps

- \* Steel caps and connection plates at Piers 3 (west of tracks), Pier 4 (east of tracks) and Pier 5: caps and connections are corroding. Recommendation: paint following the manufacturer's surface prep requirements.

**BRIDGE INSPECTION REPORT**

Status: Released

Printed On: 10/6/2017

Agency: City/Other Park, Forest, or Reservation Agency

CD Guid: dd7cc383-0312-421c-bb55-8a177d457d03

CD Date: 7/24/2017

Program Mgr: Roman G. Peralta

<b>Br. No.</b> BRG-079	<b>SID</b> 08567700	<b>Br. Name</b> CARKEEK PARK PED /RR	
<b>Carrying</b> PEDESTRIAN		<b>Route On</b>	<b>Mile Post</b>
<b>Intersecting</b> NPRR		<b>Route Under</b>	<b>Mile Post</b>

**Notes (Continued)**

260 Steel Grid (west stairs)

- \* Top of 2nd landing, E-edge: pack rust with section loss on the grated landing platform support in contact with the east L-bracket. Recommendation: paint following the manufacturer's surface prep requirements. Platform has a slight wobble due to the support's section loss no longer fully seated onto the L-bracket. Consider replacing east L-bracket with a longer top flange. Notify Parks Maintenance to evaluate and repair as needed
- \* Top of 1st landing from the W-abut - E-edge: cold galvanized paint repair of landing platform ledge - corrosion re-appearing along the top edges - Recommendation: platform has a slight wobble due to support's section loss no longer fully seated onto the L-bracket. Consider replacing east L-bracket with a longer top flange. Notify Parks Maintenance to evaluate and repair as needed
- \* At the landing south of the south most steel bent, the east angle supporting the steel grating is detached from channel at the south 2 feet - CTO.

340 Metal Pedestrian Railing

- \* At west stairwell, middle landing, bottom rail of east pipe railing has begun to crack. The crack is at a weld joint and the east 1/2 of the rail is cracked - CTO.
- \* E-end\_S-side: From the east, 9th fence section - corroded, section loss at lower horizontal rail to post interface - Recommend - either replacing lower rail, splicing new lower rail section to post, or adding new short vertical member securing lower rail to beam. Notify Parks Maintenance to evaluate and repair as needed

904 Paint

- \* See notes under steel rolled girder, caps and columns.
- \* Fence posts and rails - typical throughout - sporadic chipped, flaking paint down to previous paint coat - no corrosion- CTO

**Repairs**

Repair No	Pr	R	Repair Descriptions	Noted	Maint	Verified
			(No repairs for this structure)			

**Inspections Performed and Resources Required**

Report Type	Date	Freq	Hrs	Insp	CertNo	Coinsp	Note
Routine	5/13/2015	24	1.0	JMO	G0101	AM	5/13/15, Routine Inspection, JMO/AM.
Interim	6/9/2016	24	1.0	JMO	G0101	KL	Interim Inspection, JMO/KL. 6/09/2016, 11:30 AM; 60°F+/-, overcast.
Primary Safety	5/26/2017	12	1.0	KL	G0520	CEH	05/26/17, Safety Inspection, KL/CEH, 1 P.M., 73°F., Sunny
Informational	5/26/2017		1.0	KL	G0520	CEH	7/24/2017 - added repair recommendation for BE 090, Steel Rolled Girder, west stair landing, 1" X 2" rusted web section loss near top of east channel beam of stairway. Recommendation: this landing's wobble warrants a closer look at a repair.



# BRIDGE INSPECTION REPORT

Status: Released

Printed On: 9/13/2018

Agency: City/Other Park, Forest, or Reservation Agency

CD Guid: 5ee60649-03f0-4e0a-bbf6-a9e029343a97

CD Date: 5/21/2018

Program Mgr: Roman G. Peralta

**Br. No.** BRG-079

**SID** 08567700

**Br. Name** CARKEEK PARK PED /RR

**Carrying** PEDESTRIAN

**Route On**

**Mile Post**

**Intersecting** NPPR

**Route Under**

**Mile Post**

Inspector's Signature JMO

Cert # G0101

Cert Exp Date 5/11/2022

Co-Inspector's Signature SJW

	<input type="checkbox"/> Structural Eval (1657)	0	<input type="checkbox"/> Operating Tons (1552)	0	<input type="checkbox"/> No Utilities (2675)	<b>Inspections Performed:</b> <table style="width: 100%; border-collapse: collapse;"> <thead> <tr> <th style="text-align: left;">Freq</th> <th style="text-align: left;">Hrs</th> <th style="text-align: left;">Date</th> <th style="text-align: left;">Rep Type</th> </tr> </thead> <tbody> <tr><td colspan="4"><b>Routine</b></td></tr> <tr><td></td><td></td><td></td><td>Fract Crit</td></tr> <tr><td></td><td></td><td></td><td>UW</td></tr> <tr><td></td><td></td><td></td><td>Special</td></tr> <tr><td colspan="4"><b>Interim</b></td></tr> <tr><td></td><td></td><td></td><td>UWI</td></tr> <tr><td></td><td></td><td></td><td>Damage</td></tr> <tr><td colspan="4"><b>PRM Safety</b></td></tr> <tr><td></td><td></td><td></td><td>SEC Safety</td></tr> <tr><td style="text-align: center;"><b>12</b></td><td style="text-align: center;"><b>1.0</b></td><td style="text-align: center;"><b>5/14/2018</b></td><td style="text-align: center;"><b>Condition</b></td></tr> <tr><td></td><td></td><td></td><td>Short Span</td></tr> <tr><td></td><td></td><td></td><td>In Depth</td></tr> <tr><td></td><td></td><td></td><td>Geometric</td></tr> </tbody> </table>			Freq	Hrs	Date	Rep Type	<b>Routine</b>							Fract Crit				UW				Special	<b>Interim</b>							UWI				Damage	<b>PRM Safety</b>							SEC Safety	<b>12</b>	<b>1.0</b>	<b>5/14/2018</b>	<b>Condition</b>				Short Span				In Depth				Geometric
Freq	Hrs	Date	Rep Type																																																													
<b>Routine</b>																																																																
			Fract Crit																																																													
			UW																																																													
			Special																																																													
<b>Interim</b>																																																																
			UWI																																																													
			Damage																																																													
<b>PRM Safety</b>																																																																
			SEC Safety																																																													
<b>12</b>	<b>1.0</b>	<b>5/14/2018</b>	<b>Condition</b>																																																													
			Short Span																																																													
			In Depth																																																													
			Geometric																																																													
9	<input type="checkbox"/> Deck Geometry (1658)		<input type="checkbox"/> Op RF (1553)	N	<input type="checkbox"/> Bridge Rails (1684)																																																											
4	<input type="checkbox"/> Underclearance (1659)	0	<input type="checkbox"/> Inventory Tons (1555)	N	<input type="checkbox"/> Transition (1685)																																																											
9	<input type="checkbox"/> Alignment (1661)		<input type="checkbox"/> Inv RF (1556)	N	<input type="checkbox"/> Guardrails (1686)																																																											
5	<input type="checkbox"/> Deck Overall (1663)		<input type="checkbox"/> Operating Level (1660)	N	<input type="checkbox"/> Terminals (1687)																																																											
7	<input type="checkbox"/> 6 Superstructure (1671)		<input type="checkbox"/> Open/Closed (1293)	0.00	<input type="checkbox"/> Asphalt Depth (2610)																																																											
6	<input type="checkbox"/> Substructure (1676)	9	<input type="checkbox"/> Waterway (1662)		<input type="checkbox"/> Design Curb Ht (2611)																																																											
9	<input type="checkbox"/> Culvert (1678)	N	<input type="checkbox"/> Scour (1680)		<input type="checkbox"/> Bridge Rail Ht (2612)																																																											
9	<input type="checkbox"/> Chan/Protection (1677)			1956	<input type="checkbox"/> Year Built (1332)																																																											
N	<input type="checkbox"/> Pier/Abut/Prot (1679)			1975	<input type="checkbox"/> Year Rebuilt (1336)																																																											
	<input type="checkbox"/> Soundings Flag (2693)		<input type="checkbox"/> Revise Rating (2688)	<table border="1" style="width: 100%; border-collapse: collapse;"> <tr><td style="text-align: center;">Sufficiency Rating</td></tr> <tr><td style="text-align: center;">No Risk Category</td></tr> </table>		Sufficiency Rating	No Risk Category																																																									
Sufficiency Rating																																																																
No Risk Category																																																																
	<input type="checkbox"/> Measure Clrnc (2694)		<input type="checkbox"/> Photos Flag (2691)																																																													
			<input type="checkbox"/> QA Flag (2695)																																																													

BMS Elements							
Element	Element Description	Total	Units	CS 1	CS 2	CS 3	CS 4
12	Concrete Deck	545	SF	241	4	300	0
90	Steel Rolled Girder	238	LF	168	0	70	0
202	Steel Pile/Column	10	EA	5	0	5	0
215	Concrete Abutment	15	LF	15	0	0	0
221	Concrete Foundation	5	EA	5	0	0	0
231	Steel Pier Cap/Crossbeam	35	LF	30	0	5	0
260	Steel Sidewalk & Supports - Open Grid	600	SF	590	0	10	0
340	Metal Pedestrian Railing	198	LF	193	0	5	0
904	Organic Zinc/Urethane Paint System	12,000	SF	1,000	0	10,000	1,000

Notes

**BRIDGE INSPECTION REPORT**

Status: Released

Printed On: 9/13/2018

Agency: City/Other Park, Forest, or Reservation Agency

CD Guid: 5ee60649-03f0-4e0a-bbf6-a9e029343a97

CD Date: 5/21/2018

Program Mgr: Roman G. Peralta

<b>Br. No.</b> BRG-079	<b>SID</b> 08567700	<b>Br. Name</b> CARKEEK PARK PED /RR
<b>Carrying</b> PEDESTRIAN		<b>Route On</b>
<b>Intersecting</b> NPRR		<b>Route Under</b>
		<b>Mile Post</b>
		<b>Mile Post</b>

**Notes (Continued)**

0 05/14/2018, Condition Inspection, JMO/SJW, 11 A.M., Sunny, 75°F.

Orientation

\* Bridge spans west to east crossing over RR tracks. The west end is near Puget Sound. The east end is near the parking lot.

\* Stairs and landings west of RR tracks oriented south to north.

Seattle Parks is bridge owner.

\* TW66864/F49

3 General Notes

\* Portions of bridge painted in 2009 except for the bents and spans over the RR tracks.

\* At main span, NW and SW steel throw fence rail posts - heavy corrosion with holes forming at the top of both throw fence posts. Recommendation - Cut out corroded portions of posts, weld in new sections and paint.

12 Concrete Deck - precast concrete deck panels

\* Deck panels east of main span - hairline cracks along top and soffit surfaces - Continue to Observe (CTO).

\* Typical along soffit surfaces - spalls w/exposed rebar and hairline cracking with rust stains - CTO.

\* Panels are secured to steel girders via weld tabs. In some cases weld tabs have broken. Some cracking and spalling of panels adjacent to embedded weld tabs - CTO.

\* Top of east approach deck panels have been ground down in 2 locations to achieve smooth transition between panels - CTO.

\* Main span - transverse hairline cracks along middle of precast panel typical - CTO.

90 Steel Rolled Girder

\* Packrust typical between weld tab embedded in concrete deck panels and top of girder - CTO.

\* East end, at tip of top flange - corrosion and section loss. Recommendation - paint.

\* Span over RR tracks - moderate corrosion. Recommendation - paint.

\* Span over RR tracks, south side, bottom flange is bent at 2 locations: above the west track and near the west abutment - CTO.

\* Span above RR tracks: cross brace rods appear loose - CTO.

\* Cross brace rods over RR tracks and span east of RR tracks - heavy corrosion. Recommendation - paint.

\* At west stair, about 1" x 2" rusted web section loss near top of east steel channel beam of stairway - CTO.

\* C-section beams supporting stairway landings - failed protective coatings along hard to reach interior areas. Recommendation - paint.

**BRIDGE INSPECTION REPORT**

Status: Released

Printed On: 9/13/2018

Agency: City/Other Park, Forest, or Reservation Agency

CD Guid: 5ee60649-03f0-4e0a-bbf6-a9e029343a97

CD Date: 5/21/2018

Program Mgr: Roman G. Peralta

<b>Br. No.</b> BRG-079	<b>SID</b> 08567700	<b>Br. Name</b> CARKEEK PARK PED /RR	
<b>Carrying</b> PEDESTRIAN		<b>Route On</b>	<b>Mile Post</b>
<b>Intersecting</b> NPRR		<b>Route Under</b>	<b>Mile Post</b>

**Notes (Continued)**

202 Steel Pile/Column

- \* Columns adjacent to RR tracks - moderate corrosion. Recommendation - paint.
- \* North column west of RR tracks, at base, above drain hole - NE column face has minor diagonal displacement, but no crack found (may be an old weld) - CTO.
- \* Packrust at exposed column base plates. At some locations, base plates are fully buried. Recommendation - Remove soil and debris and clean and paint base plates.

215 Abutment

- \* Dirt and debris on top of east abutment. Recommendation - Remove dirt and debris.

221 Concrete Foundation

- \* No defects noted at exposed column footings. At some locations, footings are fully buried.

231 Steel Caps

- \* Steel caps above columns - corrosion along flange edges and at bolted connections. Recommendation - paint.

260 Steel Grid (west stairs)

- \* At the middle landing - tread is missing support in SE corner and deflects when stepped on because east angle supporting the steel grating has severe corrosion and is detached from channel at south 2 feet. Recommendation - Replace east angle.
- \* At the lower landing, at east end of steel grating, at extreme south face - minor section loss above east angle - CTO.

340 Metal Pedestrian Railing

- \* At west stairway, middle landing, bottom rail of east pipe railing has begun to crack. The crack is at a weld joint and the east 1/2 of the rail is cracked - CTO.
- \* At west stairway, railing was measured at 36 inch height. Current IBC and AASHTO standard is 42 inch height. Recommendation - Consider retrofit of railing at stairway.
- \* At east approach to main span, south rail, bottom tube has corrosion - CTO.
- \* Fence posts and rails - typical throughout - sporadic chipped, flaking paint down to previous paint coat - no corrosion- CTO

904 Paint

- \* Recommendation - Clean and paint girders, caps and columns per manufacturers' preparation requirements.

**Repairs**

Repair No	Pr	R	Repair Descriptions	BMS	Noted	Maint	Verified
			(No repairs for this structure)				

**Inspections Performed and Resources Required**

Report Type	Date	Freq	Hrs	Insp	CertNo	Coinsp	Note
Condition	5/14/2018	12	1.0	JMO	G0101	SJW	05/14/2018, Condition Inspection, JMO/SJW, 11 A.M., Sunny, 75°F.

# BRIDGE INSPECTION REPORT

Status: Released

Printed On: 11/25/2020

Agency: City/Other Park, Forest, or Reservation Agency

CD Guid: f1334121-2f92-44e5-8a08-f4d266407160

Release Date: 6/15/2020

Program Mgr: Roman G. Peralta

**Br. No.** BRG-079

**SID** 08567700

**Br. Name** CARKEEK PARK PED /RR

**Carrying** PEDESTRIAN

**Route On**

**Mile Post**

**Intersecting** NPPR

**Route Under**

**Mile Post**

Inspector's Signature PZ

Cert # G1808

Cert Exp Date 4/3/2023

Co-Inspector's Signature GF

## Inspections Performed

Report Type	Inspection Type	Date	Freq	Hours	Inspector	Cert No	Co-Insp.
<b>Condition</b>		<u>5/6/2020</u>	<u>12</u>	<u>1.0</u>	<u>PZ</u>	<u>G1808</u>	<u>GF</u>

9	<input type="checkbox"/> Alignment (1661)	0	<input type="checkbox"/> Operating Tons (1552)	N	<input type="checkbox"/> Bridge Rails (1684)	0	<input type="checkbox"/> No Utilities (2675)
5	<input type="checkbox"/> Deck Overall (1663)		<input type="checkbox"/> Op RF (1553)	N	<input type="checkbox"/> Transition (1685)	0.00	<input type="checkbox"/> Asphalt Depth (2610)
6	<input type="checkbox"/> Superstructure (1671)	0	<input type="checkbox"/> Inventory Tons (1555)	N	<input type="checkbox"/> Guardrails (1686)	1956	<input type="checkbox"/> Year Built (1332)
6	<input type="checkbox"/> Substructure (1676)		<input type="checkbox"/> Inv RF (1556)	N	<input type="checkbox"/> Terminals (1687)	1975	<input type="checkbox"/> Year Rebuilt (1336)
9	<input type="checkbox"/> Culvert (1678)		<input type="checkbox"/> Operating Level (1660)		<input type="checkbox"/> Bridge Rail Ht (2612)		
9	<input type="checkbox"/> Chan/Protection (1677)		<input type="checkbox"/> Open/Closed (1293)		<input type="checkbox"/> Design Curb Ht (2611)		
N	<input type="checkbox"/> Pier/Abut/Prot (1679)		<input type="checkbox"/> Structural Eval (1657)				
9	<input type="checkbox"/> Waterway (1662)	9	<input type="checkbox"/> Deck Geometry (1658)				
N	<input type="checkbox"/> Scour (1680)	4	<input type="checkbox"/> Underclearance (1659)				

NBIS Risk Category

---

No Risk Category

## Inspection Flags

<input type="checkbox"/> Soundings (2693)	<input type="checkbox"/> Measure Clearance (2694)	<input type="checkbox"/> Revise Rating (2688)	<input type="checkbox"/> Photos (2691)	<input type="checkbox"/> QA Flag (2695)
---	---	---	--	---

## BMS Elements

Element	Element Description	Total	Units	CS 1	CS 2	CS 3	CS 4
12	Concrete Deck	545	SF	241	4	300	0
90	Steel Rolled Girder	238	LF	168	0	70	0
202	Steel Pile/Column	10	EA	5	0	5	0
215	Concrete Abutment	15	LF	15	0	0	0
221	Concrete Foundation	5	EA	5	0	0	0
231	Steel Pier Cap/Crossbeam	35	LF	30	0	5	0
260	Steel Sidewalk & Supports - Open Grid	600	SF	590	0	10	0
340	Metal Pedestrian Railing	198	LF	193	0	5	0
904	Organic Zinc/Urethane Paint System	12000	SF	1000	0	10000	1000

## Notes

--

**BRIDGE INSPECTION REPORT**

Status: Released

Printed On: 11/25/2020

Agency: City/Other Park, Forest, or Reservation Agency

CD Guid: f1334121-2f92-44e5-8a08-f4d266407160

Release Date: 6/15/2020

Program Mgr: Roman G. Peralta

**Br. No.** BRG-079

**SID** 08567700

**Br. Name** CARKEEK PARK PED /RR

**Carrying** PEDESTRIAN

**Route On**

**Mile Post**

**Intersecting** NPRR

**Route Under**

**Mile Post**

**Notes (Continued)**

0 Orientation

Seattle Parks Owned.

- \* Bridge spans west to east crossing over RR tracks. The west end is near Puget Sound. The east end is near the parking lot.
- \* Stairs & landings west of RR tracks oriented south to north.
- \* TW66864/F49 (old charge code), TRR0008-R0809 (new speedtype)

3 General Notes

- \* Establish a cleaing plan that will be implemented every 24 months to prevent corrosion.
- \* At main span, NW &SW steel throw fence rail posts - heavy corrosion with holes forming at the top of both throw fence posts. Recommendation - Cut out corroded portions of posts, weld in new sections and paint.

12 Concrete Deck (Precast concrete deck panels) Inspected from ground surface. Did not have access to soffits.

- \* Deck panels east of main span - hairline cracks along top & soffit surfaces.
- \* Top of east approach deck panels have been ground down in 2 locations to achieve smooth transition between panels.
- \* Main span - transverse hairline cracks along middle of precast panel typical.

90 Steel Rolled Girder

- \* Packrust typical between weld tab embedded in concrete deck panels & top of girder.
- \* East end, consistently along top flange - corrosion and section loss (up to 1/8" loss on width of flange). Recommendation - clean & paint w/ zinc.
- \* Span over RR tracks - moderate corrosion. Recommendation - clean & paint.
- \* Cross brace rods over RR tracks and span east of RR tracks - heavy corrosion. Recommendation - clean & paint.
- \* C-section beams supporting stairway landings - failed protective coatings along hard to reach interior areas. Recommendation - clean & paint.

202 Steel Pile/Column

- \* Packrust at exposed column base plates. At some locations, base plates are fully buried. Recommendation - Remove soil and debris and clean and paint base plates.

215 Abutment

- \* Dirt and debris on top of east abutment. Recommendation - Remove debris, paint with zinc.

221 Concrete Foundation

- \* Footings are fully buried not visible.

231 Steel Caps

- \* Steel caps above columns - corrosion along flange edges along length of cap and at bolted connections. Recommendation - paint.

260 Steel Grid (west stairs)

- \* At the lower landing, at east end of steel grating, at extreme south face - minor section loss above east angle.



**BRIDGE INSPECTION REPORT**

Status: Released

Printed On: 11/25/2020

Agency: City/Other Park, Forest, or Reservation Agency

CD Guid: f1334121-2f92-44e5-8a08-f4d266407160

Release Date: 6/15/2020

Program Mgr: Roman G. Peralta

**Br. No.** BRG-079

**SID** 08567700

**Br. Name** CARKEEK PARK PED /RR

**Carrying** PEDESTRIAN

**Route On**

**Mile Post**

**Intersecting** NPRR

**Route Under**

**Mile Post**

**Notes (Continued)**

340 Metal Pedestrian Railing

\* Stairway, middle landing, bottom rail of east pipe railing has begun to crack. The crack is at a weld joint and the east 1/2 of the rail is cracked.

\* Stairway, railing was measured at 36 inch height. Current IBC and AASHTO standard is 42 inch height. Recommendation - Consider retrofit of railing at stairway.

\* East approach to main span, south rail, bottom tube has corrosion.

904 Paint (Portions of bridge painted in 2009 except for the bents and spans over the RR tracks)

\* Recommendation - Clean and paint girders, caps and columns per manufacturers' preparation requirements.

**Repairs**

Repair No	Pr	R	Repair Descriptions	BMS	Noted	Maint	Verified
10000	1	B	Remove debris from abutment at the bearing area to prevent corrosion.		5/6/2020		
10001	2	B	Repair deck fence supports that have section loss		5/6/2020		
10002	1	B	Clean and complete spot painting with zinc to slow corrosion.		5/6/2020		

**Inspections Performed and Resources Required**

Report Type	Date	Freq	Hrs	Insp	CertNo	Coinsp	Note
Condition	5/6/2020	12	1.0	PZ	G1808	GF	05/06/2020, Condition Inspection, PZ/GF, 10:00 A.M., Sunny, 60°F.

## APPENDIX A.3

### FIELD VISIT MEMO AND OTHER BACKUP INFORMATION

**The City of Seattle**

**Seattle Parks and Recreation (SPR)**

**Carkeek Park Pedestrian Bridge Replacement Feasibility Study**

**Site Visit Memorandum**

**Time:** 11:00 AM to 1:00 PM

**Date:** October 19, 2020

**Location:** Carkeek Park, 950 NW Carkeek Park Road, Seattle, WA 98177

**Attendees:**

<b>Name</b>	<b>Organization</b>	<b>Role</b>	<b>Notes</b>
Colin Campbell	SPR	Project Manager	
Ted Orr	SPR	Maintenance	
Eduardo Aban	SPR	Engineer	
Jane Li	RHC	Project Manager	
Jimmy Chen	RHC	Structural Lead	
John Vaudreuil	RHC	Senior Engineer	
Stephen Van Dyck	LMN	Lead Architect	
Adam Amrhein	LMN	Urban Design Lead	
Scott Crawford	LMN	Principal Designer	
Rives Kitchell	LMN	Project Architect	
Kerem Kalkay	Shannon & Wilson	Geotechnical Engineer	

The site visit started with the whole group conversation standing in a big circle at the lawn area for social distancing. Everyone had the mask on. Ted Orr introduced the bridge history. After a brief conversation, the group was divided into two sub-groups to the bridge site. The summary of this site visit includes major topics discussed during the field meeting.

**Meeting Notes:**

<p><b>Bridge History and Discussions for Bridge Replacement</b></p> <p>Ted introduced the recent bridge maintenance history, and difficulties in access to the braced piers for maintenance.</p> <p>Several guardrails, bracings and pipes have been through repairs and replacement, especially at the bridge end platform area. Bracing was tightened from the accessible end. Painting is by the SPR maintenance crew and typically to accessible members from the bridge top.</p> <p>Stephen asked about the stair grid deck and how it was procured. Ted mentioned fiberglass deck for low maintenance, and that no records showing whether the existing galvanized steel grid was a separate bid item or not, and whether it was daylight requirement related or not.</p> <p>Jimmy asked about painting frequencies and access. Bridge maintenance over BNSF adds costs from BNSF staff coordination hours. Trains pass over 10 times a day, and each train is typically miles long. During the team’s time there, there were at least two trains passing by in the opposite directions.</p> <p>Jane asked about the original construction access records. It was not known how the existing bridge was built and the construction access was achieved. There was no record on the latest bridge construction date. The date shown on the as-built drawings may not reflect the actual construction time.</p> <p>Colin mentioned that replacing the bridge in the existing footprint if possible. Coordinating with BNSF is needed for extending the bridge footprint and keeping the existing bridge open during construction. The group discussed ways to reduce BNSF constraints if possible for speedy construction.</p> <p>Ted mentioned how heavily used the bridge is by school and children groups during the day midweek, in addition to the heavy weekend and evening use.</p> <p>Group discussed that the bridge is used both for access to the beach, as well as a viewpoints towards the water and especially towards the trains passing below. Group discussed how the views of trains is especially important for young children and attracts them from both the beach and playground sides of the bridge.</p>	
<p><b>Existing Bridge Condition</b></p> <ul style="list-style-type: none"><li>• The deck was made from precast panels bolted onto the top flange; the top flange has significant corrosion at the panel joints and bolt connection area. The deck concrete has cracking, spalls at the anchor area, and fluorescent water stain underneath.</li><li>• The chain link fence enclosure and the diagonal braces are different from the as-built plans.</li><li>• The steel grid stair was much about a structural consideration instead of environmental consideration when the bridge was built.</li></ul>	
<p><b>Site Condition:</b></p> <ul style="list-style-type: none"><li>• ADA access is not required for beach access. Stephen proposed a forward compatibility approach to consider the possibility in the future.</li></ul>	

<ul style="list-style-type: none"> <li>• ADA access is required at the parking side. The trail at south of the bridge is not ADA accessible. Therefore an ADA connection to the trail to south is not needed.</li> <li>• Approaches for construction access include land, water and air access. Land access from the parking lot requires close coordination with BNSF. Water access through a barge may trigger additional environmental permits, and also need to look at how close the barge can access to the beach. Jimmy mentioned a past project example with helicopter lifted materials and components for construction.</li> <li>• The team has agreed that AASHTO LRFD Guide Specifications for Pedestrian Bridges should be used for this project.</li> <li>• Seismic liquefaction is likely at the bridge site. Tsunami effect does not need to be considered and is not required by the AASHTO standard.</li> </ul>	
<p><b>BNSF:</b></p> <ul style="list-style-type: none"> <li>• Group discussed the possibility of at least eliminating one pier that is located inside the BNSF fence causing challenging maintenance access.</li> <li>• The existing bridge does not meet BNSF vertical clearance requirements. Two existing dents were observed and were recorded in the inspection reports.</li> <li>• Stephen mentioned LMN's other projects that took a long time to coordinate with BNSF.</li> </ul>	
<p><b>Replacement Discussions:</b></p> <ul style="list-style-type: none"> <li>• Due to the BNSF coordination requirements and train schedule, rapid construction will be beneficial. Consider using prefabricated superstructure and substructure, if possible.</li> <li>• The existing pier near the BNSF fence will be eliminated due to difficulty in maintenance access.</li> <li>• Foundation construction at the beach side is challenging due to access issues.</li> </ul>	

**The City of Seattle**

**Seattle Parks and Recreation (SPR)**

**Carkeek Park Pedestrian Bridge Replacement Feasibility Study**

**Kick-Off Meeting**

**Time:** 10:00 AM to 11:00 AM

**Date:** October 15, 2020

**Location:** Virtual online through Microsoft Teams Meeting

**Attendees:**

<b>Name</b>	<b>Organization</b>	<b>Role</b>	<b>Notes</b>
Colin Campbell	SPR	Project Manager	
Jane Li	RHC	Project Manager	
Jimmy Chen	RHC	Structural Lead	
John Vaudreuil	RHC	Senior Engineer	
McKenna Miller	RHC	Project Coordinator	
Stephen Van Dyck	LMN	Lead Architect	
Adam Amrhein	LMN	Urban Design Lead	
Scott Crawford	LMN	Designer	
Rives Kitchell	LMN	Project Architect	
Bill Perkins	Shannon & Wilson	Lead Geotechnical Engineer	
Kerem Kalkay	Shannon & Wilson	Geotechnical Engineer	



**Meeting Notes:**

<p><b>Project overview</b>          The initial part of the project will be the assessment of the current bridge. Due to maintenance reports, the bridge is in need of replacement, funding and the future is uncertain right now, so Parks is determining what is a 'now' versus a 'wait' project.          Approach to construction and cost will both be important for replacement development, with the goal to reduce community impact if possible, a major constraint is cost.  <i>Eduardo and Ted will be on site Monday to answer more technical-based questions.</i></p>	Colin
<p><b>Project Schedule</b></p> <ul style="list-style-type: none"> <li>• The project schedule is about four months with first 60 calendar days focusing on assessment and alternatives development and second 60 calendars on concept report. Monday is the site visit. <u>December 8<sup>th</sup></u> is set to present the replacement alternative for Parks' approval. Report of existing structures assessment will be about 30 calendar days after notice to proceed (aim is the beginning of November).</li> <li>• Consider weekly check-in with the tight schedule.</li> <li>• Working with integrated team including Colin to help get consistent feedback/dialogue and build a shared vision during weekly check-in, possibly moving over to Zoom and away from Microsoft Teams as it is more fluid to editing while in meetings.</li> <li>• <i>Consultant to set up Zoom Meetings</i> as Colin can't set up via Zoom</li> </ul>	Jane  Jimmy  Stephen  Colin
<p><b>Project Goals and questions:</b></p> <ul style="list-style-type: none"> <li>• Connecting the place as a feature of the park to welcome people is a major bonus/goal. ADA access to the <i>beach</i> is not required due to the nature of the beach per City's ADA coordinator. A viewpoint on the bridge for ADA access is ideal.</li> <li>• SPR concurrent projects in the park: SPR is working on the playground at Carkeek but is not anticipating any conflicting. Collin can provide the playground project information if needed</li> <li>• Funding source will be from local taxes. The consultant team could support additional federal funding application.</li> <li>• The bridge would be replaced in place, the project team will look at BNSF agreement for options, SPR will provide CAD survey data later.</li> <li>• To determine using IBC or AASHTO design code for the bridge, Colin will check with SPR engineers.</li> <li>• BNSF agreement coordination: safer to use existing agreement before attempting to request a new agreement.</li> </ul>	Colin & team
<p><b>Site Visit:</b></p> <ul style="list-style-type: none"> <li>• The gates at Carkeek Park should be opening on Monday. If the gates aren't open, Ted will be there with a key to let the team in. Can meet by the gates by the entrance until then if arriving early. In terms of safety, limited to five people, so have to remain in separate groups to accommodate that. The main concern is being outside with other families/visitors if the park is open. Want to set a good example as representatives, so safety is the main goal.</li> <li>• RHC/LMN team members will mingle into two separate groups while there. Gear: Masks require d. Yellow safety jacket/vest. No helmet.</li> </ul>	Colin          Jane and team

## **The City of Seattle**

### **Seattle Parks and Recreation (SPR)**

#### **Carkeek Park Pedestrian Bridge Replacement Feasibility Study**

##### **Initial questions for discussion during kick-off and site visit**

1. How can this project support Seattle Park's mission? What are SPR's main goals for the project?
2. What are the goals around outreach and engagement? Will there be coordination with Tribes?
3. Are there north/south limits to the bridge alignment?
4. What is the ADA sphere of influence?
5. Along the Shoreline, are there known critical constraints about footprints/structures/extents that we should start with?
6. What is the expected integration with existing park spaces and trails? Should the study consider opportunities?
7. Have there been any NEW coordination/agreements between Parks and BNSF?
8. Does the existing bridge need to be operational during construction?
9. How did past maintenance access done at the water side?
10. Will the new bridge walkway be the same width or can it be wider than the existing one?
11. Does SPR require IBC or AASHTO code for the bridge design?

## Slab Assessment

---

Deck slab                      3.5" with #4@9"

h=            3.5            in  
b=            12            in  
d=            0.5            in  
s=            9            in  
As=          0.262        in<sup>2</sup>  
Fy=          40.0        ksi  
f'c=          4.0           ksi  
c=            1.000        in            clearance  
Φ=            0.9  
ΦMn=        1.67        k-ft  
Mu=          0.669        k-ft  
OK

Wide Flange and Channel  
Assessment

Steel Wide Flange Section Capacity

References :  
AASHTO LRFD Bridge Design Specifications, 8th Edition, November 2017  
AISC Steel Construction Manual, Fifteenth Edition, May 2017

	WF10x25	WF14x34	C12X20.7	
Section Area	A = 6.09	8.31	6.09	in <sup>2</sup>
Depth	d = 9.90	13.98	12.00	in
Web thickness	t <sub>w</sub> = 0.25	0.29	0.28	in
Width of flange	b <sub>f</sub> = 5.75	6.75	2.94	in
Flange thickness	t <sub>f</sub> = 0.22	0.23	0.45	in
Elastic section modulus about X-axis	S <sub>xx</sub> = 16.64	31.04	21.50	in <sup>3</sup>
Moment of Inertia about X-axis	I <sub>xx</sub> = 97.51	248.29	129.00	in <sup>4</sup>
Elastic section modulus about Y-axis	S <sub>yy</sub> = 3.63	5.16	1.73	in <sup>3</sup>
Moment of Inertia about Y-axis	I <sub>yy</sub> = 10.43	17.41	3.88	in <sup>4</sup>

6.5355125

1) Flexural Resistance of Non-composite steel section

(i) Cross-Section Proportion Limits

AASHTO 6.10.2

	WF10x25	WF14x34	C12X20.7				
Web depth	D = 9.46	13.52	11.10	in		AISC Table 1-1	
Web thickness	t <sub>w</sub> = 0.25	0.285	0.282	in			
D/t <sub>w</sub> (without web stiffeners)	D/t <sub>w</sub> = 37.85	47.44	39.36	<=	150	OK	AASHTO Eq.6.10.2.1.1-1
D/t <sub>w</sub> (with web stiffeners)	D/t <sub>w</sub> = 37.85	47.44	39.36	<=	300	OK	AASHTO Eq.6.10.2.1.2-1
Width of flange	b <sub>f</sub> = 5.75	6.745	2.942	in			
Thickness of flange	t <sub>f</sub> = 0.22	0.23	0.45	in			
b <sub>f</sub> /2t <sub>f</sub>	b <sub>f</sub> /2t <sub>f</sub> = 13.07	14.66	3.27	>	12	NG	AASHTO Eq.6.10.2.2-1
b <sub>f</sub> /(D/6)	b <sub>f</sub> /(D/6) = 3.65	2.99	1.59	>	1	OK	AASHTO Eq.6.10.2.2-2
t <sub>f</sub> /(1.1t <sub>w</sub> )	t <sub>f</sub> /(1.1t <sub>w</sub> ) = 0.80	0.73	1.45	<=	1	NG	AASHTO Eq.6.10.2.2-3
Inertia of compression flange about vertical axis	I <sub>yc</sub> = 0.01	0.01	0.02	in <sup>4</sup>			
Inertia of tension flange about vertical axis	I <sub>yt</sub> = 0.04	0.05	0.02	in <sup>4</sup>			
I <sub>yc</sub> /I <sub>yt</sub>	I <sub>yc</sub> /I <sub>yt</sub> = 0.12	0.13	1	>=	0.1	OK	AASHTO Eq.6.10.2.2-4
				<=	10	OK	
Slenderness ratio for the compression flange	λ <sub>f</sub> = 13.07	14.66	3.27				λ <sub>f</sub> = b <sub>f</sub> /2t <sub>f</sub> AASHTO Eq.6.10.8.2.2-3
Modulus of Elasticity	E = 29000	29000	29000	ksi			
Minimum Yield stress of compression flange	F <sub>yc</sub> = 36	36	36	ksi			
Limiting slenderness ratio for compact flange	λ <sub>pf</sub> = 10.79	10.79	10.79				λ <sub>pf</sub> = 0.38*SQRT(E/F <sub>yc</sub> ) AASHTO Eq.6.10.8.2.2-4
Limiting slenderness ratio for noncompact flange	λ <sub>rf</sub> = 15.89	15.89	15.89				λ <sub>rf</sub> = 0.56*SQRT(E/F <sub>yc</sub> )

(ii) Local Buckling Resistance of Compression Flange

	WF10x25	WF14x34	C12X20.7		
2Dc/tw=	38	47	39		
λ <sub>rw</sub>	161.78	161.78	161.78	=5.7sqrt(E/Fyc)	
awc=	1.87	2.48	2.36	2Dc*tw/bfc/tfc=D*tw/bf/ft	
R <sub>b</sub>	1.0	1.0	1.0		AASHTO 6.10.8
R <sub>h</sub>	1.0	1.0	1.0		AASHTO 6.10.1.10.1
F <sub>yc</sub>	36	36	36	ksi	MBE Table 6A.6.2.1-1
F <sub>nc(FLB)</sub>	31.17	27.80	36.00	ksi	F <sub>nc</sub> = R <sub>b</sub> R <sub>h</sub> F <sub>yc</sub> AASHTO Eq.6.10.8.2.2-1

(iii) Lateral Torsional Buckling

	WF10x25	WF14x34	C12X20.7		
Depth of web in compression in the elastic range	D <sub>c</sub> = 5.86	8.00	6.00	in	
Width of compression flange	b <sub>fc</sub> = 5.75	6.745	2.942	in	b <sub>fc</sub> = b <sub>f</sub> for rolled shapes
Thickness of web	t <sub>w</sub> = 0.25	0.285	0.282	in	
Thickness of compression flange	t <sub>fc</sub> = 0.22	0.23	0.45	in	t <sub>fc</sub> = t <sub>f</sub> for rolled shapes
Effective radius of gyration for lateral torsional buckling	r <sub>t</sub> = 1.41	1.60	0.71	in	
Limiting unbraced length	L <sub>p</sub> = 3.33	3.77	1.68	ft	L <sub>p</sub> = 1.0r <sub>t</sub> *SQRT(E/F <sub>yc</sub> ) AASHTO Eq.6.10.8.2.3-9
Unbraced Length provided	L <sub>b</sub> = 13.75	12.5	1	ft	AASHTO Eq.6.10.8.2.3-4
	L <sub>b</sub> >	>	<	L <sub>p</sub>	
Comp. flange stress at the onset of nominal yielding	F <sub>yr</sub> = 25.2	25.2	25.2	ksi	= MIN(0.7F <sub>yc</sub> , 0.7F <sub>yw</sub> ) [F <sub>yc</sub> =F <sub>yw</sub> ] .3
Limiting unbraced length to achieve the onset of yielding	L <sub>r</sub> = 12.52	14.17	6.32	ft	L <sub>r</sub> = π*r <sub>t</sub> *SQRT(E/F <sub>yr</sub> ) AASHTO Eq.6.10.8.2.3-5
	L <sub>b</sub> >	<	<	L <sub>r</sub>	Non Compact Unbraced Length
Moment gradient factor	C <sub>b</sub> = 1	1	1		Conservative
(L <sub>b</sub> -L <sub>p</sub> )/(L <sub>r</sub> -L <sub>p</sub> )	1.13	0.84	-0.15		
F <sub>yr</sub> /R <sub>h</sub> F <sub>yc</sub>	0.7	0.7	0.7		
C <sub>r</sub>	20.9	32.4	36.0	ksi	C <sub>b</sub> R <sub>b</sub> π <sup>2</sup> E/(L <sub>b</sub> /rt) <sup>2</sup>
F <sub>nc(LTB)</sub>	20.9	26.9	36.0	ksi	AASHTO Eq.6.10.8.3.2.3-2
F <sub>nc</sub>	20.9	26.9	36.0	ksi	F <sub>nc</sub> = MIN(F <sub>nc(FLB)</sub> , F <sub>nc(LTB)</sub> ) For Compression flange
The nominal flexural strength	M <sub>n</sub> = 28.98	69.67	64.50	kip-ft	M <sub>n</sub> = F <sub>nc</sub> *I/y

$$F_{nc} = C_b \left[ 1 - \left( 1 - \frac{F_{yr}}{R_h F_{yc}} \right) \left( \frac{L_b - L_p}{L_r - L_p} \right) \right] R_b R_h F_{yc} \leq R_b R_h F_{yc}$$

Wide Flange and Channel  
 Assessment

Resistance factor	$\phi_r =$	1.00	1.00	1.00		AASHTO 6.5.4.2
Factored Flexural strength	$M_r =$	29.0	69.7	64.5	kip-ft	$M_r = \phi_r M_n$

2) **Shear Resistance of Non-composite Steel section**  
 (i) Unstiffened Section

Minimum yielding moment for web	$F_{yw} =$	36	36	36	ksi	MBE Table 6A.6.2.1-1
Thickness of web	$t_w =$	0.25	0.285	0.282	in	
Shear buckling coefficient	$k =$	5.0	5.0	5.0		AASHTO 6.10.9.2
Web depth	$D =$	9.4625	13.52	11.1	in	
	$D/t_w =$	37.85	47.44	39.36		
	$1.12 \cdot \text{SQRT}(Ek/F_{yw}) =$	71.08	71.08	71.08		
	$D/t_w \leq$	$\leq$	$\leq$	$\leq$	$1.12 \cdot \text{SQRT}(Ek/F_{yw})$	
Ratio of shear buckling resistance to shear yield strength	$C =$	1	1	1		AASHTO Eq.6.10.9.3.2-4
Plastic Shear Force	$V_p =$	49.39	80.45	65.36	kips	$V_p = 0.58F_{yw}Dt_w$ AASHTO Eq.6.10.9.2-2
Shear yielding or shear buckling resistance	$V_n = V_{cr} =$	49.39	80.45	65.36	kips	$V_{cr} = CV_p$ AASHTO Eq.6.10.9.2-1
Resistance factor for shear	$\phi_v =$	1.0	1.0	1.0		AASHTO 6.5.4.2
Factored Shear resistance	$V_r =$	49.4	80.5	65.4	kips	

PIPE  
 Assessment

**Shear**

$V_n = 0.5F_{cr}A_g$			6.12.1.2.3c-1
$F_{cr} = \max(\min(1.6E/\sqrt{L_v/D}/(D/t)1.25, 0.58F_y), \min(0.78E/(D/t)^{1.5}, 0.58F_y))$			
$F_y =$	36	36 ksi	
$E =$	29000	29000 ksi	
$D_o =$	6.625	6.625 in	
$t =$	0.432	0.18 in	
$L_v =$	23.75	23.75 ft	
$F_{cr} =$	20.88	20.88 ksi	
$A_g =$	8.40	3.68 in <sup>2</sup>	
$I_g =$	40.49	18.62 in <sup>4</sup>	
$V_n =$	87.75	19.20 kips	
$\Phi_v =$	1.00	1.00	
$\Phi_v V_n =$	87.75	19.20 kips	

**Flexural**

$M_n = M_p = F_y Z$ for $D/t \leq 0.07E/F_y$			6.12.2.2.3-1
$D/t =$	15.34	37.48	
$0.45E/F_y =$	362.5	362.5	
$0.31E/F_y =$	249.7	249.7	
$0.07E/F_y =$	56.39	56.39	
$Z =$	11.28	5.91 in <sup>3</sup>	
$M_n =$	33.84	17.73 k-ft	
$\Phi_f =$	1.00	1.00	
$M_r = \Phi_f M_n =$	33.84	17.73 k-ft	

**Compression**

$P_r = \Phi_c P_n$		
$A_g =$	8.40	3.68 in <sup>2</sup>
$\Phi_c =$	0.9	0.9
$\lambda_r =$		
$P_e = \pi^2 E A_g / (K L / r_s)^2$		
$K =$	1	1
$L =$	285	285
$r_s =$	2.19	2.25 in
$P_e =$	142.68	65.63 kips
$P_0 = F_y A_g =$	302.58	132.43 kips
$P_e / P_0 =$	0.47	0.50
$P_n = P_0 * 0.658^{(P_0 / P_e)}$ , if $P_e / P_0 \geq 0.44$		
$P_n = 0.877 P_e$ , if $P_e / P_0 < 0.44$		
$P_n =$	124.55	56.91 kips
$\Phi_c =$	0.95	0.95
$\Phi_c P_n =$	118.33	54.06 kips
	As-Built	Corroded



**Appendix B**  
**Geotechnical Report**

SUBMITTED TO:  
RHC Engineering, Inc.  
720 3rd Avenue, Suite 1400  
Seattle, WA 98104

BY:  
Shannon & Wilson  
400 N. 34th Street, Suite 100  
Seattle, WA 98103

(206) 632-8020  
[www.shannonwilson.com](http://www.shannonwilson.com)

GEOTECHNICAL REPORT  
Carkeek Park Pedestrian Bridge  
Feasibility Study  
SEATTLE, WASHINGTON

Submitted To: RHC Engineering, Inc.  
720 3rd Avenue, Suite 1400  
Seattle, WA 98104

Subject: GEOTECHNICAL REPORT, CARKEEK PARK PEDESTRIAN BRIDGE  
FEASIBILITY STUDY, SEATTLE, WASHINGTON

Shannon & Wilson prepared this report and participated in this project as a subconsultant to RHC Engineering, Inc. Our scope of services was specified in an agreement with RHC dated October 8, 2020. This report presents the results of our preliminary geotechnical engineering analyses and was prepared by the undersigned.

We appreciate the opportunity to be of service to you on this project. If you have questions concerning this report, or we may be of further service, please contact us.

Sincerely,

SHANNON & WILSON

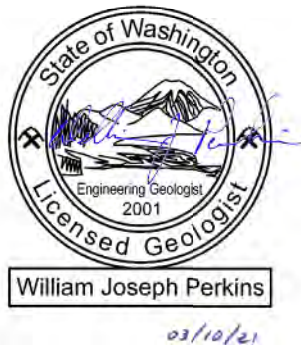

William Joseph Perkins

William J. Perkins, PE, LEG  
Vice President

KDK:WJP/kdk

1 Site and Project Description.....1

2 Subsurface Conditions.....1

    2.1 Soil Conditions .....1

    2.2 Groundwater Conditions .....2

3 Geotechnical Engineering Studies and Recommendations.....3

    3.1 Design Criteria.....3

    3.2 Seismic Design Ground Motions .....3

    3.3 Seismically Induced Geologic Hazards.....4

    3.4 Foundation Requirements .....5

        3.4.1 Spread Footing Bearing Resistance.....6

        3.4.2 Deep Foundation Axial Resistance .....7

        3.4.3 Deep Foundation Lateral Resistance .....8

4 Closure and Limitations.....9

5 References .....9

Tables

Table 1: Summary of Recommended Seismic Design Parameters

Table 2: Summary of Estimated Bearing Resistances for Existing Spread Footing Foundations

Figures

Figure 1: Vicinity Map

Figure 2: Geologic Map and Existing Exploration Locations

Figure 3: Recommended Seismic Design Spectra Based on USGS 2014 Seismic Hazard Maps

Figure 4: Recommended Seismic Design Spectra Based on USGS 2018 Seismic Hazard Maps

Figure 5: Recommended Lateral Spreading Induced Earth Pressures Acting on Deep Foundations, Shore-side (West of Rail)

Figure 6: Factored Bearing Resistance versus Footing Width, Rectangular Footing, L/B = 1, Parking Area-side (Approach Footings)

Figure 7: Factored Bearing Resistance versus Footing Width, Rectangular Footing, L/B = 10, Parking Area-side (Approach Footings)

- Figure 8: Factored Bearing Resistance versus Footing Width, Rectangular Footing,  $L/B = 1$ , Parking Area-side (Large Footing)
- Figure 9: Factored Bearing Resistance versus Footing Width, Rectangular Footing,  $L/B = 10$ , Parking Area-side (Large Footing)
- Figure 10: Factored Bearing Resistance versus Footing Width, Rectangular Footing,  $L/B = 1$ , Shore-side
- Figure 11: Factored Bearing Resistance versus Footing Width, Rectangular Footing,  $L/B = 10$ , Shore-side
- Figure 12: Estimated Axial Resistance, 9-in-diam Micropile, Parking Area-side (East of Rail)
- Figure 13: Estimated Axial Resistance, 9-in-diam Micropile, Shore-side (West of Rail), Liquefaction to 30 feet
- Figure 14: Estimated Axial Resistance, 9-in-diam Micropile, Shore-side (West of Rail), Liquefaction to 60 feet
- Figure 15: Estimated Axial Resistance, 12-in-diam Micropile, Parking Area-side (East of Rail)
- Figure 16: Estimated Axial Resistance, 12-in-diam Micropile, Shore-side (West of Rail), Liquefaction to 30 feet
- Figure 17: Estimated Axial Resistance, 12-in-diam Micropile, Shore-side (West of Rail), Liquefaction to 60 feet
- Figure 18: Estimated Axial Resistance, 1.5-ft-diam Drilled Shaft, Parking Area-side (East of Rail)
- Figure 19: Estimated Axial Resistance, 1.5-ft-diam Drilled Shaft, Shore-side (West of Rail), Liquefaction to 30 feet
- Figure 20: Estimated Axial Resistance, 1.5-ft-diam Drilled Shaft, Shore-side (West of Rail), Liquefaction to 60 feet
- Figure 21: Estimated Axial Resistance, 3-ft-diam Drilled Shaft, Parking Area-side (East of Rail)
- Figure 22: Estimated Axial Resistance, 3-ft-diam Drilled Shaft, Shore-side (West of Rail), Liquefaction to 30 feet
- Figure 23: Estimated Axial Resistance, 3-ft-diam Drilled Shaft, Shore-side (West of Rail), Liquefaction to 60 feet

## Appendices

Appendix A: Existing Subsurface Explorations

Important Information



## ACRONYMS

AASHTO	American Association of State Highway and Transportation Officials
bgs	beneath ground surface
ft	feet or foot
LRFD	Load and Resistance Factor Design
LS	Limit State
Qal	Holocene alluvium deposits
Qb	Holocene beach deposits
Qpf	Pleistocene Pre-Vashon deposits
S&W	Shannon & Wilson
SWIF	Southern Whidbey Island Fault
USGS	U.S. Geological Survey
WDNR	Washington State Department of Natural Resources
WSDOT	Washington State Department of Transportation

# 1 SITE AND PROJECT DESCRIPTION

The existing Carkeek Park Pedestrian Bridge is located in the western extent of Carkeek Park in Seattle, Washington, about 280 feet (ft) north of Piper's Creek (see Figure 1). The bridge spans over the double-track BNSF rail alignment, allowing pedestrian access from a park parking area on the east, to the Carkeek Park Beach and Puget Sound on the west (Figure 2). The bridge site slopes down from an elevation of about 35 ft near the parking lot to about elevations 20 and 15 ft at the BNSF rail alignment and shore landing, respectively. Within the vicinity of the bridge, the slope on both the east and west sides of the BNSF rail alignment are about 1.2 Horizontal to 1 Vertical or flatter. These slopes are vegetated with deciduous trees and shrubs. The slope on the east side of the BNSF rail alignment typically increases in steepness north of the bridge site.

Based on construction drawings (i.e., as-builts) we reviewed, the existing Carkeek Park Pedestrian Bridge is supported on shallow, spread footing foundations. Nearest the parking area, the bridge is supported on an approximate 4-ft-wide by 24-ft-long wing wall. At the shore-side stair landing, a 5-ft by 6-ft-wide spread footing supports the bridge. In between these areas, the bridge is supported on 3.5- to 4-ft-wide, square spread footings, which taper up to 16 by 16 inches in plan dimension at the top of the footings. During the Design Team's field visit on October 19, 2020, we confirmed the 16- by 16-inch top of footing dimensions.

# 2 SUBSURFACE CONDITIONS

Our characterization of the subsurface conditions of the Carkeek Park Pedestrian Bridge site for this feasibility study is based on existing geologic and subsurface data, including 1:24,000-scale geologic maps and subsurface exploration data available in Shannon & Wilson's (S&W's) internal database and the Washington State Department of Natural Resources (WDNR) Geologic Information Portal. Based on our review of the geologic maps and the available subsurface explorations in the vicinity, the east end of the bridge is underlain by very dense/hard glacially overridden Quaternary Pre-Vashon deposits (Qpf), while the west side of the bridge is underlain by relatively loose Holocene alluvium (Qal) and Holocene beach deposits (Qb) (see Figure 2).

## 2.1 Soil Conditions

Based on our review of the geologic maps, the near surface soils east of the BNSF rail alignment at the site are a result of the Pleistocene glaciation between 13,000 and 20,000

years ago, as well as geologic processes since the end of the Pleistocene epoch. These soils consist of dense to very dense, interbedded sand; gravel; and very stiff/hard silt. West of this area and extending south to Piper's Creek, the near-surface soils are Holocene-age alluvial fan deposits from Piper's Creek. These soils consist of loose to dense sand, silt, gravel, and cobbles. We note that the geologic maps also indicate the presence of Holocene beach (Hb) deposits north and west of the west end of the bridge. These soils typically consist of loose to dense sand and gravel.

We found logs of the following two existing borings in our review of S&W's internal database and the WDNR Geologic Information Portal:

- Boring B-4, completed in 2019, was accomplished about 600 ft north of the site along the eastern boundary of the BNSF rail alignment to a depth of about 41.5 ft. The near-surface soils encountered in the boring consisted of medium dense to very dense/very stiff to hard silt with sand. The soil density typically increases with increasing depth, and the soil gradation typically increases in particle size, grading to silty sand, down to the bottom of the boring.
- Boring TB-19, completed in 1972, was accomplished about 100 to 250 ft south of the site, near Piper's Creek, to a depth of about 26.5 ft. The soils encountered in the boring consisted of very loose to loose sand and silt with trace gravel and scattered organics.

The approximate location of borings B-4 and TB-19 are shown in Figure 2. Logs of borings B-4 and TB-19 are provided in Appendix A. We note the surficial subsurface conditions described on the logs of these borings are consistent with the geologic units shown on the 1:24,000-scale geologic maps at the site.

For the purpose of our preliminary engineering studies, we have assumed the surficial subsurface conditions encountered in boring B-4 as representative of the area east of the BNSF rail alignment and boring TB-19 as representative west of this area.

## 2.2 Groundwater Conditions

Given the site proximity to Piper's Creek and the Puget Sound shore, we assume the site groundwater table varies between the creek, high tide, and low tide elevations. The groundwater levels also likely fluctuate seasonally, and perched groundwater may be located above soil contacts with less pervious glacially overridden soils and may exist during wetter winter/spring seasons.



### 3 GEOTECHNICAL ENGINEERING STUDIES AND RECOMMENDATIONS

We conducted preliminary engineering studies to develop geotechnical recommendations for conceptual bridge design. Our analyses were based on discussion with the Design Team, and our recommendations and the results of our engineering studies consider the following:

- Design Criteria;
- Seismic Design Ground Motions;
- Seismically Induced Geologic Hazards; and
- Foundation Requirements.

Our engineering studies are based on the limited existing geotechnical data presented in Section 2.1. In order to develop recommendations for final bridge design, we recommend explorations be accomplished near the proposed bridge foundations on both sides of the BNSF rail alignment.

#### 3.1 Design Criteria

We understand that the proposed bridge will be designed in accordance with the American Association of State Highway and Transportation Officials (AASHTO) Load and Resistance Factor Design (LRFD) Bridge Design Specifications (AASHTO, 2020). As such, design foundation loads, load combinations, and load factors will follow AASHTO specifications. Based on the date of this report's preparation, the latest governing edition of AASHTO is the 9th edition, published in 2020.

#### 3.2 Seismic Design Ground Motions

The seismic design ground motions developed for the site are based on AASHTO (2020). Per AASHTO (2020), these earthquake ground motions are defined as those with a probability of exceedance of 7% in 75 years, which corresponds to a return period of approximately 1,000 years. We developed the 1,000-year return period seismic ground motion based on both the 2014 and 2018 U.S. Geological Survey (USGS) ground motion hazards for National Earthquake Hazards Reduction Program Site Class B/C boundary conditions. The ground motions were modified based on the assumed soil conditions at the bridge using the revised Site Coefficients in the 2020 Washington State Department of Transportation (WSDOT) Bridge Design Manual (WSDOT, 2020a).

Based on our assumed soil conditions at the site, we recommend Site Class C at the parking area-side of the site east of the BNSF rail alignment. To the west of BNSF rail alignment (shore-side of the site), we recommend either Site Class D or E. We have prepared seismic design horizontal acceleration spectra for Site Classes C, D, and E in Figures 3 and 4 for the 2014 and 2018 USGS seismic hazard maps, respectively. Table 1 also presents the seismic design ground motion parameters.

### 3.3 Seismically Induced Geologic Hazards

Based on the results of our preliminary subsurface characterization and experience in similar soil and project conditions, we evaluated potential geologic hazards that could affect the design and construction of the proposed bridge. Furthermore, we reviewed the available geologic hazard maps published by the WDNR on their Geologic Information Portal.

Seismically induced geologic hazards that may affect a given site include landsliding, fault-related ground rupture, and liquefaction and its associated effects on soils (such as loss of shear strength, bearing capacity failure, settlement, and lateral spreading/flow failure). Each of these seismically induced geologic hazards are discussed below:

- **Seismically Induced Landsliding:** Based on our review of landslide hazard maps, there are mapped known and potential landslide areas north and south of the site, including slides that S&W has responded to at BNSF's request in the past. However, we note that bridge site falls outside the mapped landslide hazard zones. The site being outside mapped landslide hazard zones is consistent with: the relatively small elevation difference between the parking lot and the beach (i.e., the ends of the bridge), and the east side of the bridge and parking area being underlain by dense to very dense, Pleistocene-age soils. Consequently, it is our opinion that the risk of seismically induced landsliding on the east side of the bridge is relatively low. Where embankment fill slopes supporting the BNSF rail alignment are supported on dense to very dense Pleistocene deposits, and assuming the embankments were appropriately placed and compacted as engineered fills, it is our opinion that the risk of these slopes failing during a seismic event would also be low. However, in our opinion, there is moderate to high potential for liquefaction-induced lateral spread and embankment instability where the embankment is underlain by Holocene alluvium and/or beach deposits (see last bullet in this section).
- **Fault-Related Ground Surface Rupture:** The nearest fault to the site is the Southern Whidbey Island Fault (SWIF) Zone, an approximately 6- to 11-kilometer-wide, northwest-trending, northeast steeply dipping zone, extending from the eastern Straits of Juan de Fuca, southeast across southern Whidbey Island and Mukilteo, and potentially as far east as Rattlesnake Mountain. The site is within 3 miles of a subparallel strand of the SWIF Zone. The SWIF Zone's recurrence interval for large



earthquakes that may rupture the ground surface appears to be on the order of at least a few thousand years. Given the distance between the site and nearest mapped strand and the relatively long recurrence interval, it is our opinion that the potential for fault-related ground surface rupture at the site is low.

- **Liquefaction:** Soil liquefaction occurs in loose, saturated, sandy soils when the water pressure in the pore spaces approaches a level that is sufficient to separate the soil particle grains from each other. This phenomenon occurs during ground shaking and results in a reduction of the soil shear strength, i.e., a quicksand-like condition. This reduction in shear strength depends on the degree and extent of the liquefaction. The degree of liquefaction depends on the consistency and density of the soil, the grain-size distribution of the soil, and the level of ground shaking at the site from a given seismic event. Soil liquefaction may result in ground settlement and reduction in bearing resistance and potential failure of foundations founded above or within these soils. Permanent lateral ground displacement, referred to as lateral spreading and flow failure, may occur on gentle slopes or on flat ground towards the nearest free face (e.g., the face of a retaining wall or slope). In addition, settlement could also result from partial liquefaction or densification of unsaturated sands. The liquefaction susceptibility of the dense to very dense, Pleistocene-age deposits east of the BNSF rail alignment near the parking area is very low. However, at the shore-side of the site, where there are very loose to loose, Holocene-age alluvial and/or beach deposits, these soils are susceptible to liquefaction, and we estimate the liquefaction potential is moderate to high. We note that liquefaction potential hazard maps published by the WDNR also indicate a moderate to high potential for liquefaction at the shore-side of the site. Based on the limited available geotechnical data we reviewed for this study, we assume liquefaction at the shore-side of the site may be expected to depths of about 30 to 60 ft beneath ground surface (bgs). The primary hazards posed by the potential for liquefaction at the shore-side of the site are liquefaction-induced settlement, reduction in soil bearing resistance, and lateral spreading/embankment instability where the railroad embankment is founded over the alluvium. The use of deep foundations as support for the bridge on the shore-side of the site would mitigate the impact of reduction in soil bearing resistance, and potentially lateral spreading/embankment instability. Design of the deep foundations should account for downdrag loads caused by liquefaction-induced settlement and lateral forces due to lateral spreading/embankment instability. Figure 5 presents our preliminary recommended lateral spreading-induced earth pressures for the conceptual deep foundations on the shore-side of the site.

### 3.4 Foundation Requirements

We understand that two bridge replacement design options are in consideration, consisting of either a truss or cable-stayed bridge. Based on correspondence with RHC Engineering, Inc., spread footings may be used as support for the proposed bridge at the parking area-side of the site and for the shore-side landing stairs. In consideration of potential

construction accessibility issues and potential liquefaction on the shore-side of the, we understand that deep foundations are also being considered as an alternative to support the proposed bridge.

The following sections discuss our recommendations regarding spread footings and deep foundations at the site.

#### 3.4.1 Spread Footing Bearing Resistance

We understand that the proposed bridge will be designed in accordance with AASHTO, which compares a factored resistance to a factored load at three distinct limit states, the: Service, Strength, and Extreme Event Limit States (LSs). The Service LS corresponds to the allowable bearing resistance that will limit the foundation settlement (typically 0.5- to 1-inch) that is dictated by the structure. For our Service LS calculations, we assumed a maximum tolerable settlement of 0.5- and 1-inch. The factored Strength and Extreme Event LS bearing resistances are computed by multiplying the nominal (i.e., unfactored) soil bearing resistance by the appropriate LRFD resistance factor to account for uncertainties in determination and variability of the actual shear strength of the soil.

At the request of RHC, we performed bearing resistance analyses for both the existing and proposed spread footings. We performed our bearing resistance analyses in accordance with AASHTO (2020), using the assumed representative soil conditions discussed in Section 2.1, and our experience in similar soil and project conditions. The analyses were performed using an in-house spreadsheet that estimates nominal bearing resistance. In accordance with AASHTO (2020) Section 10.6.3.1.2c, we also considered the effect of footings founded on or adjacent to sloping ground by applying reduction coefficients to our estimated factored bearing resistances, where appropriate. The reduction coefficients are a function of soil properties, footing geometry, and ground slope geometry.

Table 2 summarizes our estimated factored bearing resistances for the existing spread footings at each of the Service, Strength, and Extreme Event LSs. In our analyses, we assumed a footing embedment of 2 ft bgs. The resistance factors used to determine the factored bearing resistances at each of the LSs are summarized in the notes under Table 1.

Figures 6 through 11 present plots of factored bearing resistance versus footing width for assumed square and continuous footings, respectively. For footings with length to width ratios varying between 1 and 10, the plots may be used to interpolate an appropriate factored bearing resistance given a specific footing width. The resistance factors used to determine the factored bearing resistances at each of the LSs are summarized in each of the figures.



We note that under the design seismic event, we assume the alluvium and/or beach deposits supporting the spread footings at the shore-side of the site will experience liquefaction. As a result, the spread footings would become unstable, experiencing a significant loss in bearing resistance and liquefaction-induced vertical and horizontal displacements. Consequently, we have not provided factored bearing resistance at the Extreme Event LS for both the existing and proposed spread footing foundations. We recommend deep foundations be used as support at the shore-side of the site. Alternatively, shallow spread footing foundations could be used if ground improvement (e.g., stone columns, compaction grouting, soil-cement columns) is used to mitigate/eliminate the liquefaction susceptibility of the Holocene soils supporting the foundations. Conceptually, the ground improvements would extend from the base of the foundations, through the liquefiable soils, to non-liquefiable soils at depth. The improved ground would extend horizontally beyond the edge of the foundation a distance equal to approximately one-third of the depth to the non-liquefiable soil deposits. For conceptual design, the Extreme LS for footings on improved ground can be taken as approximately twice the Strength LS provided in Table 2.

### 3.4.2 Deep Foundation Axial Resistance

At the request of RHC, we performed deep foundation axial resistance analyses for 9- and 12-inch-diameter micropiles, in addition to 1.5- and 3-ft-diameter drilled shafts. We performed our axial resistance analyses in accordance with AASHTO (2020), using the assumed representative soil conditions discussed in Section 2.1 and our experience in similar soil and project conditions. The analyses were performed using an in-house spreadsheet that estimates nominal (i.e., unfactored) axial compression resistance by summing the nominal side resistance along the side of the foundation and the nominal base resistance at the foundation tip.

Deep foundations designed using the LRFD method are proportioned so that the factored axial resistance provided by the soil is at least equal to the factored axial load applied to the foundations at the Service, Strength, and Extreme Event LSs. The factored axial resistance is defined as the nominal resistance provided by the soil, multiplied by appropriate LRFD resistance factors to account for uncertainties in determination and variability of the actual shear strength of the soil. The factored axial load is defined as the nominal load multiplied by an LRFD load factor.

To account for potential disturbance during construction, contributions to axial resistance within the upper 5 ft of the deep foundations is ignored in our analyses. For non-redundant drilled shafts, where a pier/column is supported on a single shaft, the resistance factors at the Strength LS are reduced by 20% in accordance with AASHTO (2020) Section 10.5.5.2.4.

Conceptually, we recommend that the deep foundations extend a minimum distance of 10 ft into very dense/hard glacially overridden soils.

Results of our axial resistance analyses are included in Figures 12 through 23 and are presented graphically in terms of plots of deep foundation penetration versus nominal side and base resistances, in addition to factored total compression resistance. Our generalized subsurface conditions are also presented in the figures. For drilled shafts at the Service LS, our preliminary recommended axial resistances are based on assumed 0.5- and 1.0-inch drilled shaft settlement for a single shaft. For the shore-side analyses at the Extreme Event LS, axial resistance above the bottom of the assumed potentially liquefiable zones is ignored. Furthermore, estimated unfactored liquefaction-induced downdrag loads are presented in the figures for the shore-side foundations. These unfactored downdrag loads should be multiplied by an appropriate LRFD load factor and used by the structural engineer in their design of the foundations at the Structural LS. As discussed above in Section 3.3, design of the deep foundations at the shore-side of the site should also account for lateral forces due to lateral spreading/embankment instability (see Figure 5).

If foundations are planned in a group configuration, recommendations for foundation groups should also be considered while designing the deep foundations in accordance with AASHTO (2020). Per AASHTO (2020) Section 10.9.1.2, reduction factors for axial resistance are not necessary for micropiles with center-to-center (c-c) spacing greater than 30 inches or 3 pile diameters, whichever is greater. Per AASHTO (2020) Section 10.8.1.2, reduction factors for axial resistance are not necessary for drilled shafts with c-c spacing greater than 4 shaft diameters. If foundation groups are planned with spacing closer than those listed above, our recommended preliminary axial resistances should be re-evaluated.

### 3.4.3 Deep Foundation Lateral Resistance

Lateral pile resistance should be considered in final deep foundation design. The computer program, LPILE (Isenhower and others, 2019), may be used by the structural engineer to develop P-Y curves for use in designing the deep foundations (i.e., piles). If needed for conceptual design, preliminary soil parameters for LPILE analyses can be included upon request.

We recommend AASHTO (2020) Table 10.7.2.4-1 be used to evaluate the group effects (p-multipliers) for laterally loaded piles placed in a group configuration. If c-c spacing is equal to, or greater than 6 pile diameters, the group effects can be considered negligible.



## 4 CLOSURE AND LIMITATIONS

This report was prepared for use by RHC for evaluation of the existing Carkeek Park Pedestrian Bridge conditions and preparation of conceptual design alternatives for a new replacement bridge. The contents of this report should not be considered as a warranty of site and subsurface conditions. Please review the important information included as an appendix in this report.

The analyses, conclusions, and conceptual recommendations presented in this report are based on:

- The limitations of our approved scope, schedule, and budget;
- Information provided by RHC during the performance of our studies;
- Our understanding of the project as described herein; and
- Limited historical data and site conditions as they presently exist, and further assume that the existing subsurface data that we reviewed are representative of the subsurface conditions at the project site.

We recommend site-specific subsurface explorations, along with laboratory testing on soil samples retrieved from the explorations, be performed for preliminary and final design of the proposed bridge structure and other proposed improvements. More detailed conceptual geotechnical recommendations will be provided after the preferred alternative is selected and more design information becomes available.

We understand that this report will be used to support conceptual design at the site being performed by RHC. Should the purpose of this report or project change, this report immediately ceases to be valid and use of it by any party without S&W's written authorization will be at the user's sole risk.

## 5 REFERENCES

American Association of State Highway and Transportation Officials (AASHTO), 2020, AASHTO LRFD bridge design specifications (9th ed.): Washington, D. C., AASHTO, 1 v.

Isenhower, W. M.; Wang, S. T.; and Vasquez, L. G., 2019, User's manual for LPILE v2019 (v. 11), a program for the analysis of deep foundations under lateral loading: Austin, Texas, Ensoft, Inc.



- Petersen, M. D.; Moschetti, M. P.; Powers, P. M.; and others, 2014, Documentation for the 2014 update of the United States national seismic hazard maps: U.S. Geological Survey Open-File Report 2014-1091, 243 p.
- Petersen, M. D.; Shumway, A. M.; Powers, P. M.; and others, 2019, The 2018 update of the US National Seismic Hazard model: Overview of model and implications, earthquake spectra: U.S. Geological Survey.
- Troost, K. G.; Booth, D. B.; Wisher, A. P.; and Shimel, S. A., 2005, Geologic map of Seattle - a progress report: U. S. Geological Survey Open File Report OF 2005-1252, scale 1:24,000.
- U.S. Geological Survey (USGS) and California Geological Survey, 2020, Quaternary fault and fold database of the United States: Available: <https://www.usgs.gov/natural-hazards/earthquake-hazards/faults?qt-science> support page related con=4#qt-science support page related con, accessed November 2020.
- Washington State Department of Natural Resources (WDNR), 2020, Geologic information portal: Available: <https://www.dnr.wa.gov/geologyportal>, accessed October and November 2020.
- Washington State Department of Transportation (WSDOT), 2020a, Bridge design manual (LRFD): Olympia, Wash., WSDOT, Manual M 23-50.20, November, available: <http://www.wsdot.wa.gov/Publications/Manuals/M23-50.htm>
- Washington State Department of Transportation (WSDOT), 2020b, Geotechnical design manual: Olympia, Wash., WSDOT, Manual M 46-03, 1 v., November, available: <http://www.wsdot.wa.gov/Publications/Manuals/M46-03.htm>

**Table 1 - Summary of Recommended Seismic Design Parameters**

Seismic Parameter <sup>1</sup>	USGS 2014 Seismic Hazard Maps			USGS 2018 Seismic Hazard Maps		
	Site Class			Site Class		
	C	D	E	C	D	E
Mapped Peak Ground Acceleration, PGA (g)	0.42	0.42	0.42	0.4	0.4	0.4
Mapped Short-Period Spectral Acceleration, $S_S$ (g)	0.96	0.96	0.96	0.93	0.93	0.93
Mapped Long-Period Spectral Acceleration, $S_1$ (g)	0.25	0.25	0.25	0.35	0.35	0.35
Peak Ground Acceleration Site Coefficient, $F_{PGA}$	1.2	1.18	1.37	1.2	1.2	1.39
Short-Period Site Coefficient, $F_a$	1.2	1.12	1.05	1.2	1.13	1.08
Long-Period Site Coefficient, $F_v$	1.5	2.09	3.03	1.5	1.96	2.62
Design Peak Ground Acceleration, $A_s$ (g)	0.5	0.49	0.57	0.48	0.48	0.56
Design Short-Period Spectral Acceleration, $S_{DS}$ (g)	1.15	1.07	1.01	1.12	1.05	1.01
Design Long-Period Spectral Acceleration, $S_{D1}$ (g)	0.38	0.53	0.77	0.52	0.67	0.9
Reference Period $T_0$ (s)	0.07	0.1	0.15	0.09	0.13	0.18
Corner Period $T_s$ (s)	0.33	0.5	0.77	0.46	0.64	0.9

NOTES:

1 The seismic parameters are based on design ground motions with a 7 percent probability of exceedance in 75 years (about a 1,000-year return period) for the Site Class B/C boundary.

2 The site factors considered in our analyses are adopted from the WSDOT BDM (2020).

g = standard gravitational acceleration; s = second; and WSDOT BDM = Washington State Department of Transportation, Bridge Design Manual

**Table 2 - Summary of Estimated Bearing Resistances for Existing Spread Footing Foundations**

Summary of Assumed Foundation Geometry <sup>1</sup>				Summary of Bearing Resistance Analyses				
Bent Designation	Footing Width, B (feet)	Footing Length to Width Ratio, L/B (-)	Assumed Ground Slope Angle <sup>2</sup>	USGS Geologic Unit Designation of Assumed Bearing Soil Stratum	Bearing Stratum Potentially Liquefiable?	Estimated Factored Bearing Resistance <sup>3</sup>		
						Strength LS (ksf)	Extreme Event LS (ksf)	Service LS (ksf)
A-1	3.8	6.3	4.35H:1V	Qpf	No	3.7	8.3	8
A-2	3.5	1	1.25H:1V	Qpf	No	1.7	3.9	8
A-3	3.5	1	Level	Qal	Yes	1.8	See Note 4	1.3
A-4	4	1	2H:1V	Qal	Yes	0.4	See Note 4	0.2
B-1	4	1	10H:1V	Qal	Yes	1.4	See Note 4	0.9
B-2	4	1	10H:1V	Qal	Yes	1.4	See Note 4	0.9
B-3	5	1.2	Level	Qal	Yes	2	See Note 4	0.8
								1.7

**NOTES:**

- The bent designations and assumed spread footing geometry are based on information included as part of the as-built plans in the PDF file named "Carkeek Bridge As-Built.pdf."
  - The assumed ground slope angles are based on ground surface elevations shown on the as-built plans, in addition to currently available LIDAR data.
  - Estimated bearing resistances are based on an assumed footing embedment depth of 2 feet. In accordance with the AASHTO LRFD BDS (2020), the following resistance factors (RFs) were considered in our analyses: Strength LSRF = 0.45; and Extreme Event and Service LSRF = 1.0.
  - During the design 1,000-year ground motion, we assume the Qal soils will liquify, resulting in significant loss of bearing resistance and liquefaction-induced vertical and horizontal displacements.
- AASHTO LRFD BDS = American Association of State Highway and Transportation Officials, Load and Resistance Factor Design, Bridge Design Specifications; LS = Limit State; Qal = Holocene alluvium deposits; Qpf = Pleistocene Pre-Yashon deposits; RF = Resistance Factor; and USGS = United States Geological Survey



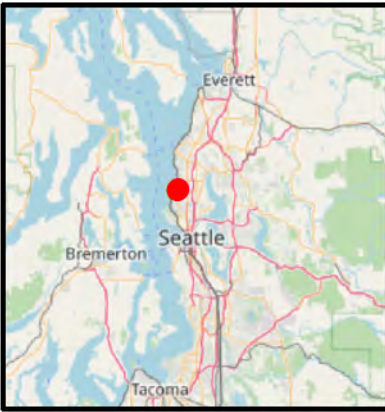

Puget Sound

BNSF Railway

Carkeek Park

Scenic

Carkeek Park Pedestrian Bridge  
Replacement Feasibility Study  
Seattle, WA

**VICINITY MAP**

March 2021

SEA-105937



**LEGEND**

● Exploration Location (Approximate) and Designation

○ BNSF Railway Milepost

— BNSF Railway

▭ 1:24k-Scale Geologic Map Units  
 Qal - Holocene Alluvium  
 Qb - Holocene Beach Deposits  
 Qpf - Quaternary Pre-Fraser Deposits

NOTE:  
 Geologic Units from Troost and others (2005) provided by WA DNR Geologic Information Portal accessed 2020.

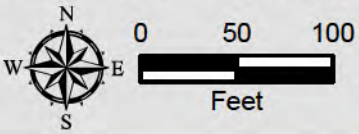

Document Path: I:\NF\SEA\105000s\105937 Carkeek Park Ped Bridge\GIS\FIG-1\_GEO\_Carkeek.mxd

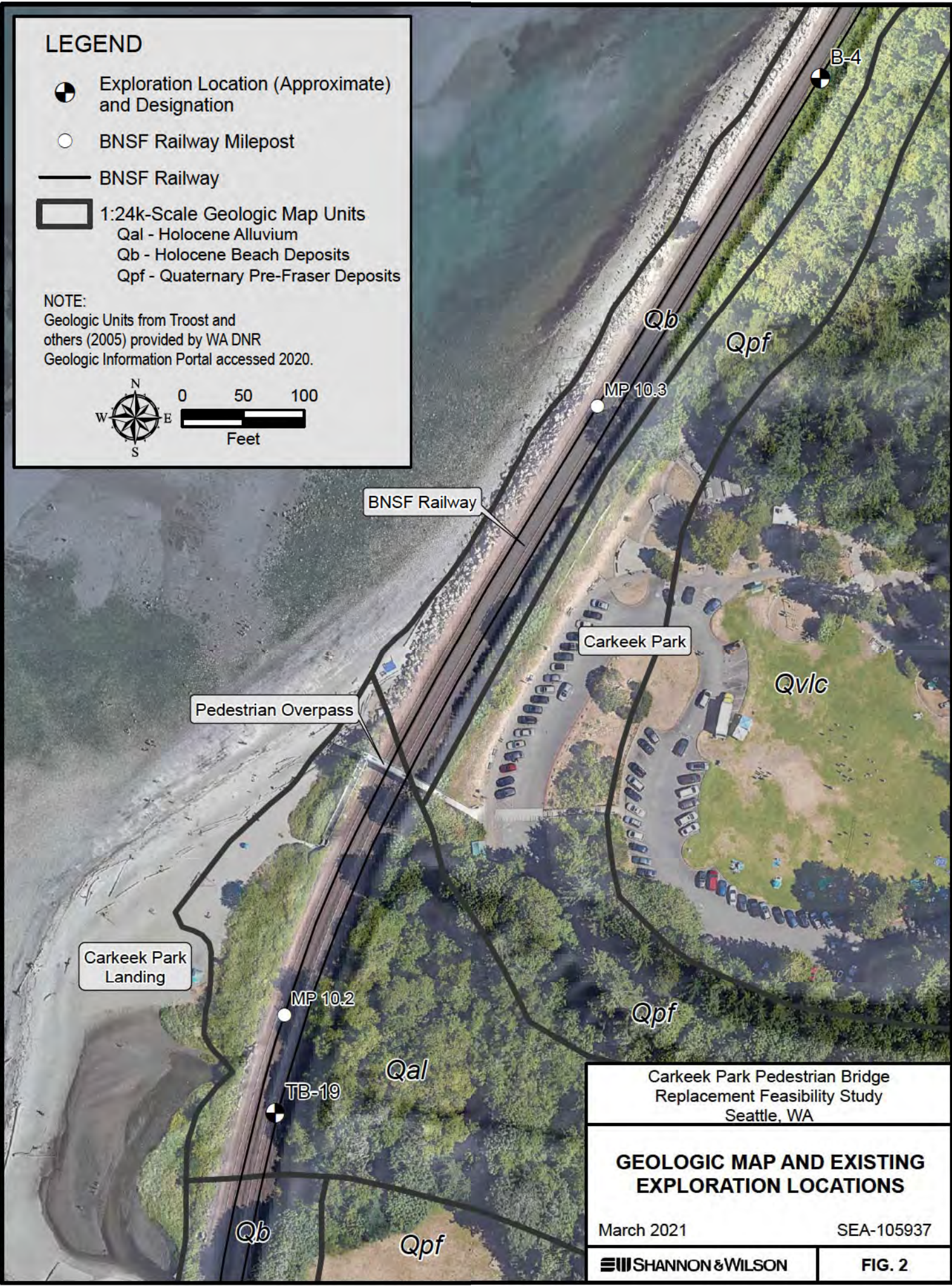

Carkeek Park Pedestrian Bridge Replacement Feasibility Study  
 Seattle, WA

**GEOLOGIC MAP AND EXISTING EXPLORATION LOCATIONS**

March 2021 SEA-105937



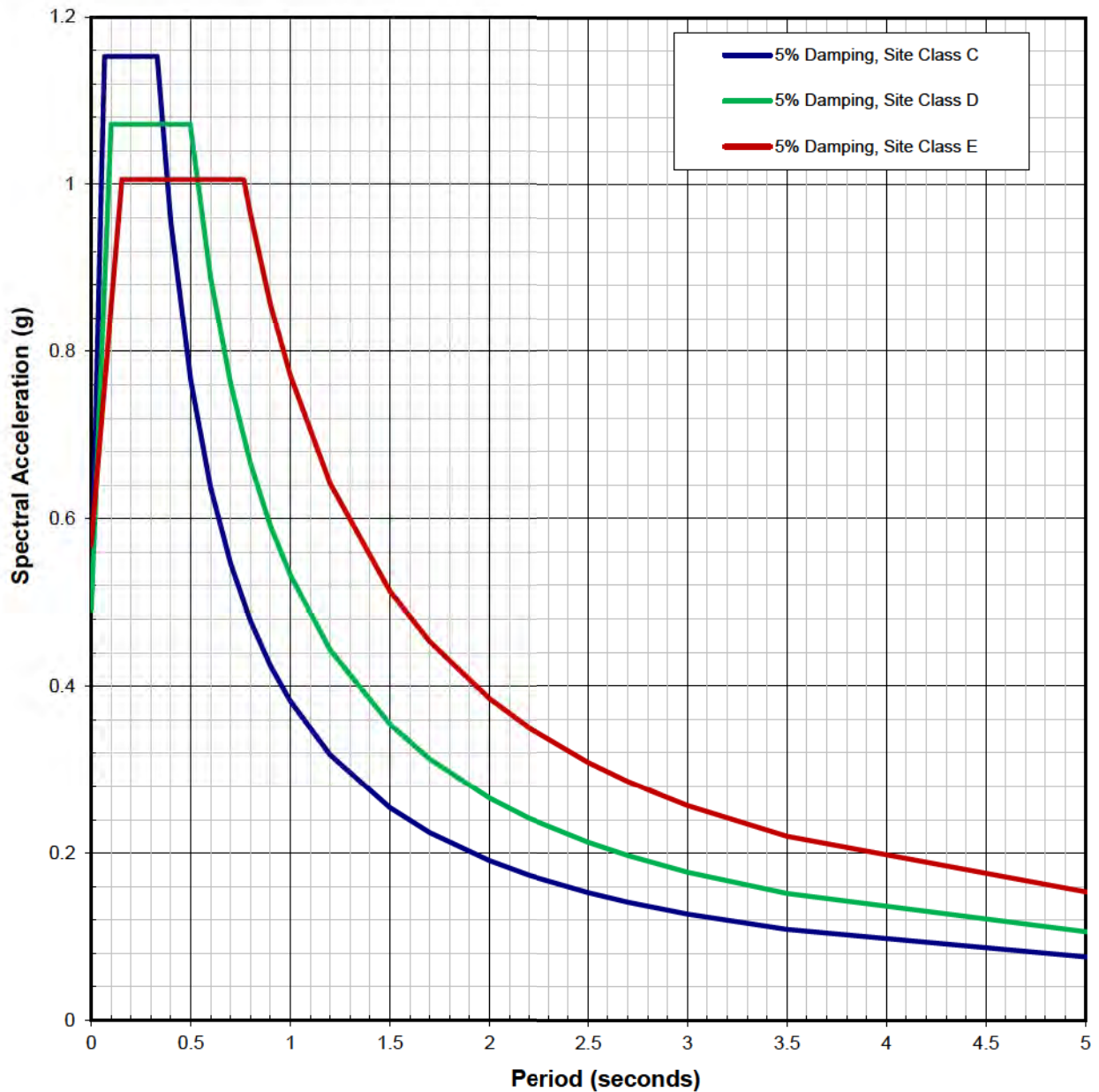

**NOTES**

1. We developed the design response spectrum based on guidance in the AASHTO LRFD BDS (2020) and the WSDOT BDM (2020).
2. The seismic design parameters are based on design ground motions with a 7 percent probability of exceedance in 75 years (about a 1,000-year return period) and are based on Site Class B/C boundary PGA,  $S_s$ , and  $S_1$  values.
3. The mapped SRA values are based on a probabilistic seismic hazard analysis performed by the USGS (Petersen and others, 2014).
4. AASHTO LRFD BDS = American Association of State Highway and Transportation Officials, Load and Resistance Factor Design, Bridge Design Specifications;  
 g = standard gravitational acceleration;  
 PGA = peak ground acceleration;  
 SRA = spectral response acceleration;  
 USGS = U.S. geological survey;  
 WSDOT BDM = Washington State Department of Transportation, Bridge Design Manual

Carkeek Park Pedestrian Bridge Replacement Feasibility Study Seattle, WA	
<b>RECOMMENDED SEISMIC                  DESIGN SPECTRA BASED ON                  USGS 2014 SEISMIC HAZARD MAPS</b>	
March 2021	SEA-105937
<b>SHANNON &amp; WILSON, INC.</b> <small>GEOTECHNICAL AND ENVIRONMENTAL CONSULTANTS</small>	<b>FIG. 3</b>

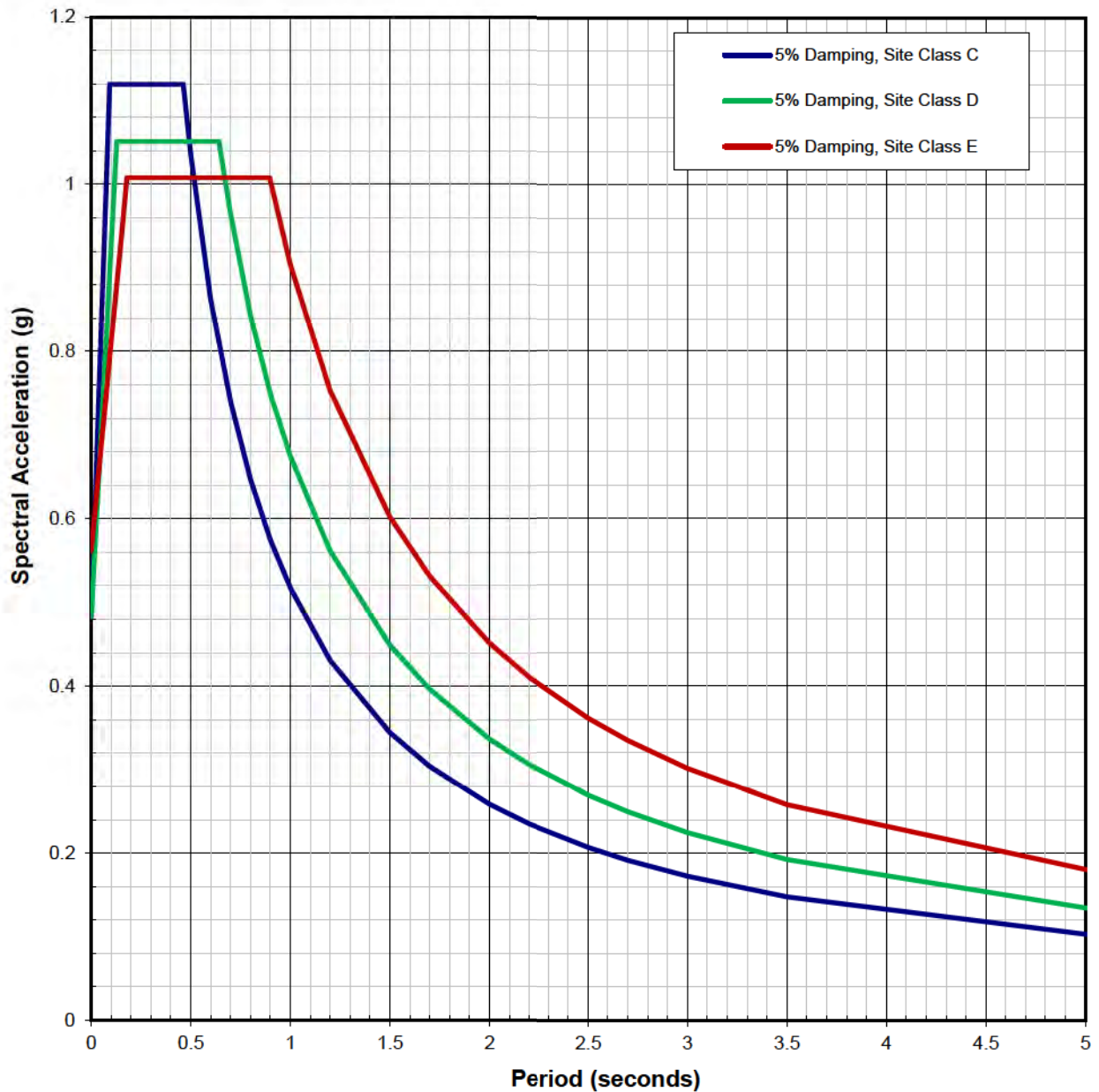

**NOTES**

1. We developed the design response spectrum based on guidance in the AASHTO LRFD BDS (2020) and the WSDOT BDM (2020).
2. The seismic design parameters are based on design ground motions with a 7 percent probability of exceedance in 75 years (about a 1,000-year return period) and are based on Site Class B/C boundary PGA,  $S_s$ , and  $S_1$  values.
3. The mapped SRA values are based on a probabilistic seismic hazard analysis performed by the USGS (Petersen and others, 2018).
4. AASHTO LRFD BDS = American Association of State Highway and Transportation Officials, Load and Resistance Factor Design, Bridge Design Specifications;  
 g = standard gravitational acceleration;  
 PGA = peak ground acceleration;  
 SRA = spectral response acceleration;  
 USGS = U.S. geological survey;  
 WSDOT BDM = Washington State Department of Transportation, Bridge Design Manual

Carkeek Park Pedestrian Bridge Replacement Feasibility Study Seattle, WA	
<b>RECOMMENDED SEISMIC                  DESIGN SPECTRA BASED ON                  USGS 2018 SEISMIC HAZARD MAPS</b>	
March 2021	SEA-105937
SHANNON & WILSON, INC. <small>GEOTECHNICAL AND ENVIRONMENTAL CONSULTANTS</small>	<b>FIG. 4</b>

**FIGURE NOT DRAWN TO SCALE**

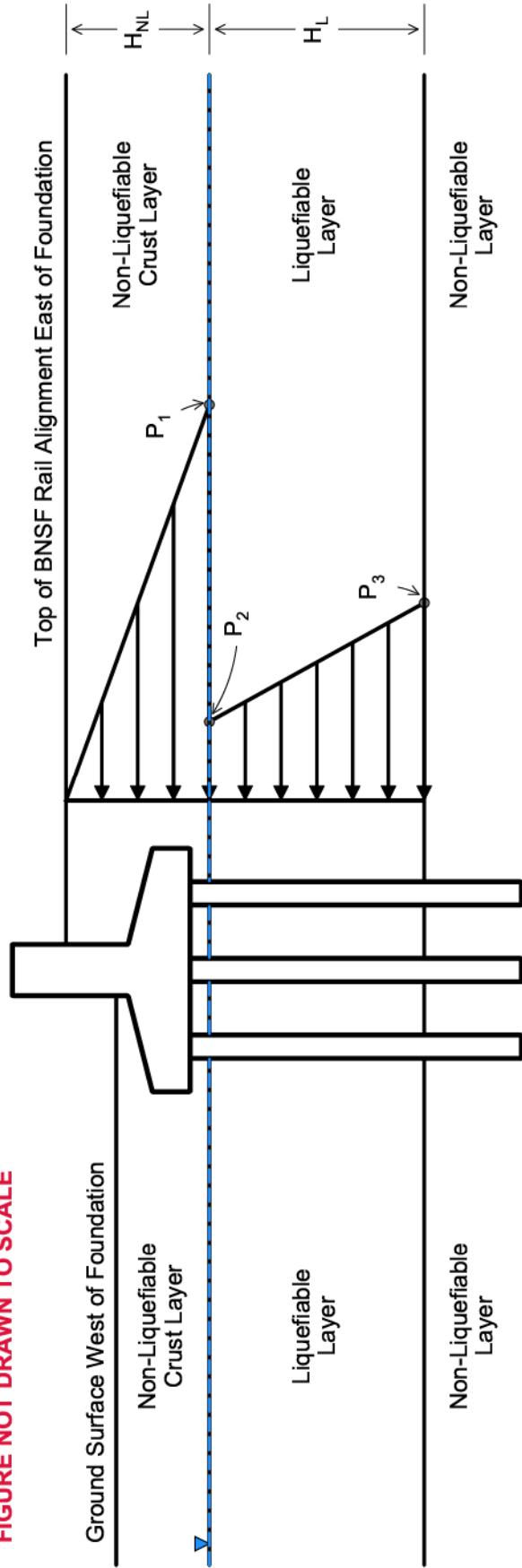

**Table: Earth Pressure Loading Parameters**

Parameter	Description	Estimated Value(s)	Units
$H_{NL}$	Thickness of non-liquefiable crust layer	10 to 15 (assumed)	feet
$H_L$	Thickness of liquefiable layer	30 to 60 (assumed)	feet
$P_1$	Estimated lateral spreading-induced earth pressure (Above liquefiable layer)	$600H_{NL}$ to $960H_{NL}$	psf
$P_2$	Estimated lateral spreading-induced earth pressure (Below non-liquefiable crust layer)	$36H_{NL}$	psf
$P_3$	Estimated lateral spreading-induced earth pressure (Bottom of liquefiable layer)	$36H_{NL} + 33H_L$	psf

**Notes:**

1. Recommended equivalent fluid weight values are in units of pounds per cubic foot (pcf), such that the recommended equivalent fluid pressure (EFP) values are in units of pounds per square foot (psf).
2. For foundation groups, apply the EFPs to the full width of the foundation group. For a single foundation element supporting a bridge pier, apply the EFPs to the width of the foundation element.
3. Lateral spreading-induced earth pressures were estimated based on the force-based methodology by Yokoyama and others (1997).
4. Lateral earth pressure analyses were performed using Coulomb's theory and an assumed interface friction angle,  $\delta$ , equal to two-thirds the soil internal angle of friction,  $\phi$ .

Carkeek Park Pedestrian Bridge  
Replacement Feasibility Study  
Seattle, WA

**RECOMMENDED LATERAL SPREADING  
INDUCED EARTH PRESSURES  
ACTING ON DEEP FOUNDATIONS  
SHORE-SIDE (WEST OF RAIL)**

March 2021 SEA-105937

**SHANNON & WILSON, INC.**  
Geotechnical and Environmental Consultants

**FIG. 5**

**FIG. 5**



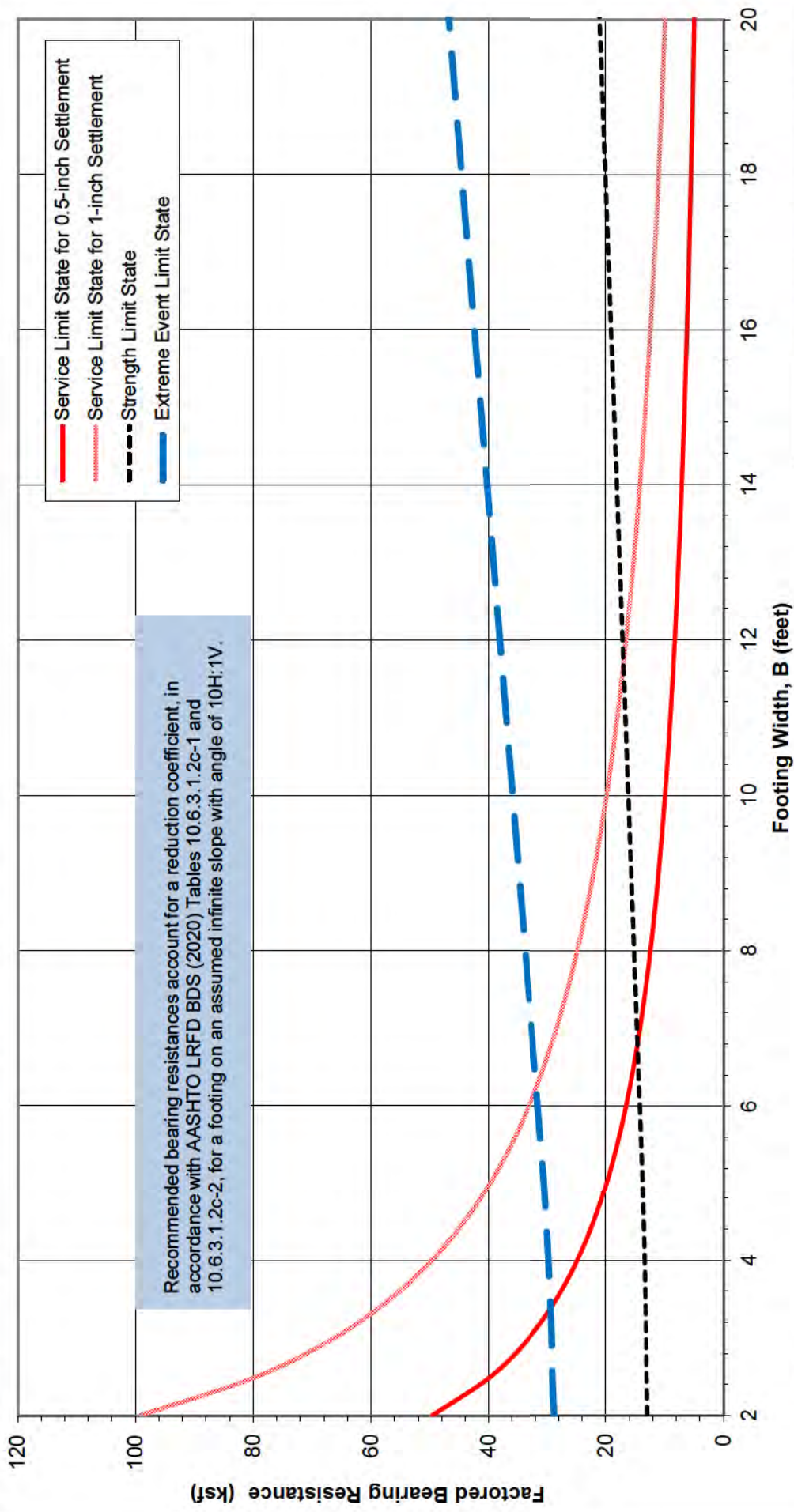

Recommended bearing resistances account for a reduction coefficient, in accordance with AASHTO LRFD BDS (2020) Tables 10.6.3.1.2c-1 and 10.6.3.1.2c-2, for a footing on an assumed infinite slope with angle of 10H:1V.

**NOTES**

- We recommend using the following resistance factors for footing LRFD design; the plotted bearing capacities use the bearing capacity resistance factors.
 

Limit State	Sliding Shear	Passive Press.	Bearing Capacity
Service Strength	N/A	N/A	1.0
Extreme Event	0.8	0.5	0.45
	1.0	1.0	1.0
- The factored bearing capacities are based on a soil friction angle of 36 degrees, a soil cohesion of 0 psf, a total unit weight of 130 pcf, a Poisson's ratio of 0.35, and a soil elastic modulus of 2,000 ksf. Our analyses assume that the bottom of the footing is 5 feet below the ground surface.
- psf - pounds per square foot; pcf - pounds per cubic foot; ksf - kips per square foot (1 kip = 1,000 pounds)

Carkeek Park Pedestrian Bridge  
Replacement Feasibility Study  
Seattle, WA

**FACTORED BEARING RESISTANCE  
VERSUS FOOTING WIDTH  
RECTANGULAR FOOTING, L/B = 1  
PARKING AREA-SIDE (APPROACH FOOTINGS)**

March 2021 SEA-105937

**SHANNON & WILSON, INC.**  
Geotechnical and Environmental Consultants

**FIG. 6**

**FIG. 6**



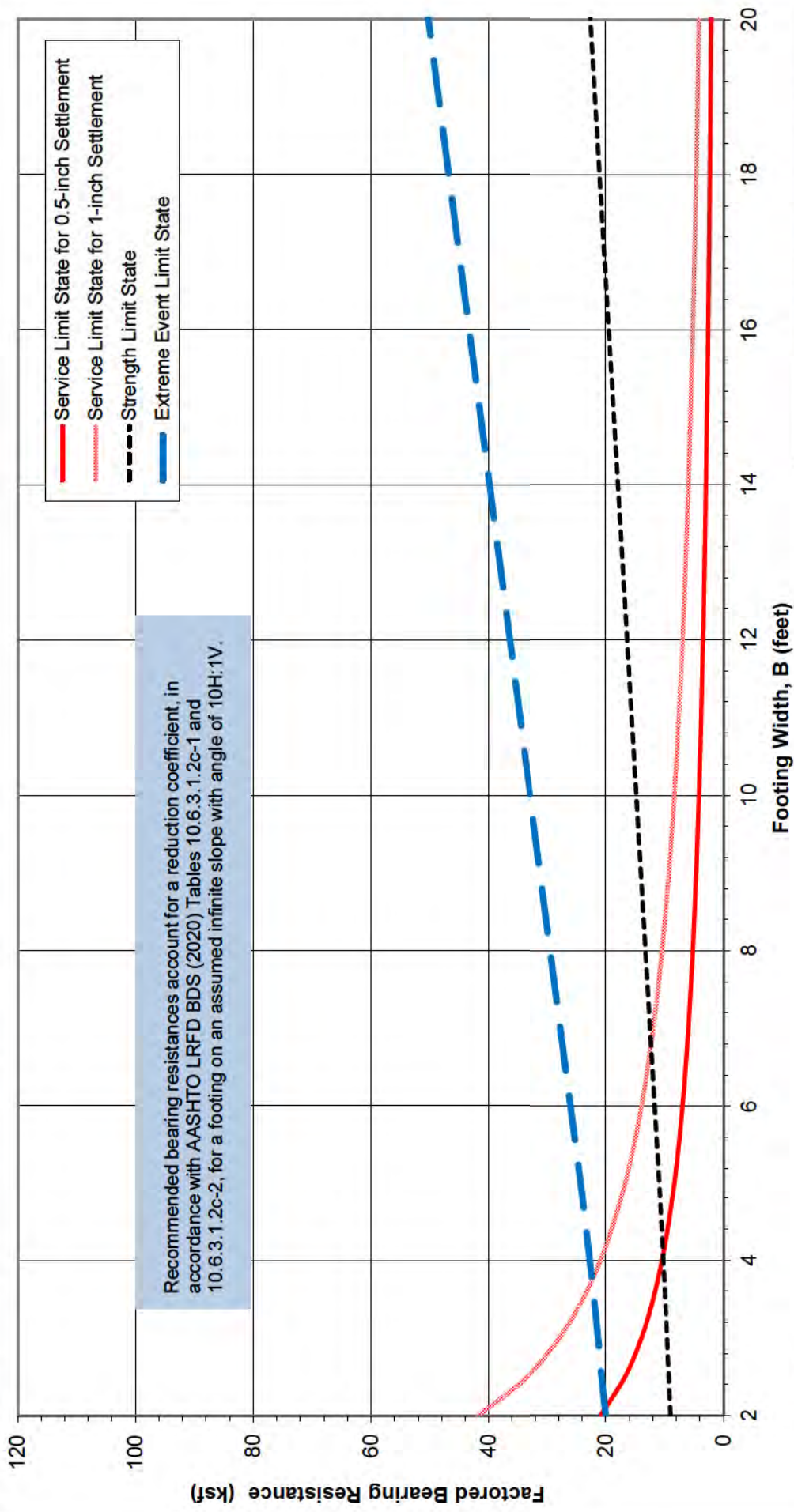

Recommended bearing resistances account for a reduction coefficient, in accordance with AASHTO LRFD BDS (2020) Tables 10.6.3.1.2c-1 and 10.6.3.1.2c-2, for a footing on an assumed infinite slope with angle of 10H:1V.

— Service Limit State for 0.5-inch Settlement  
- - - Service Limit State for 1-inch Settlement  
- - - Strength Limit State  
- - - Extreme Event Limit State

**NOTES**

- We recommend using the following resistance factors for footing LRFD design; the plotted bearing capacities use the bearing capacity resistance factors.
 

Limit State	Sliding Shear	Passive Press.	Bearing Capacity
Service Strength	N/A	N/A	1.0
Extreme Event	0.8	0.5	0.45
	1.0	1.0	1.0
- The factored bearing capacities are based on a soil friction angle of 36 degrees, a soil cohesion of 0 psf, a total unit weight of 130 pcf, a Poisson's ratio of 0.35, and a soil elastic modulus of 2,000 ksf. Our analyses assume that the bottom of the footing is 5 feet below the ground surface.
- psf - pounds per square foot; pcf - pounds per cubic foot; ksf - kips per square foot (1 kip = 1,000 pounds)

Carkeek Park Pedestrian Bridge  
Replacement Feasibility Study  
Seattle, WA

---

**FACTORED BEARING RESISTANCE  
VERSUS FOOTING WIDTH  
RECTANGULAR FOOTING, L/B = 10  
PARKING AREA-SIDE (APPROACH FOOTINGS)**

March 2021      SEA-105937

---

**SHANNON & WILSON, INC.**  
Geotechnical and Environmental Consultants

**FIG. 7**

**FIG. 7**

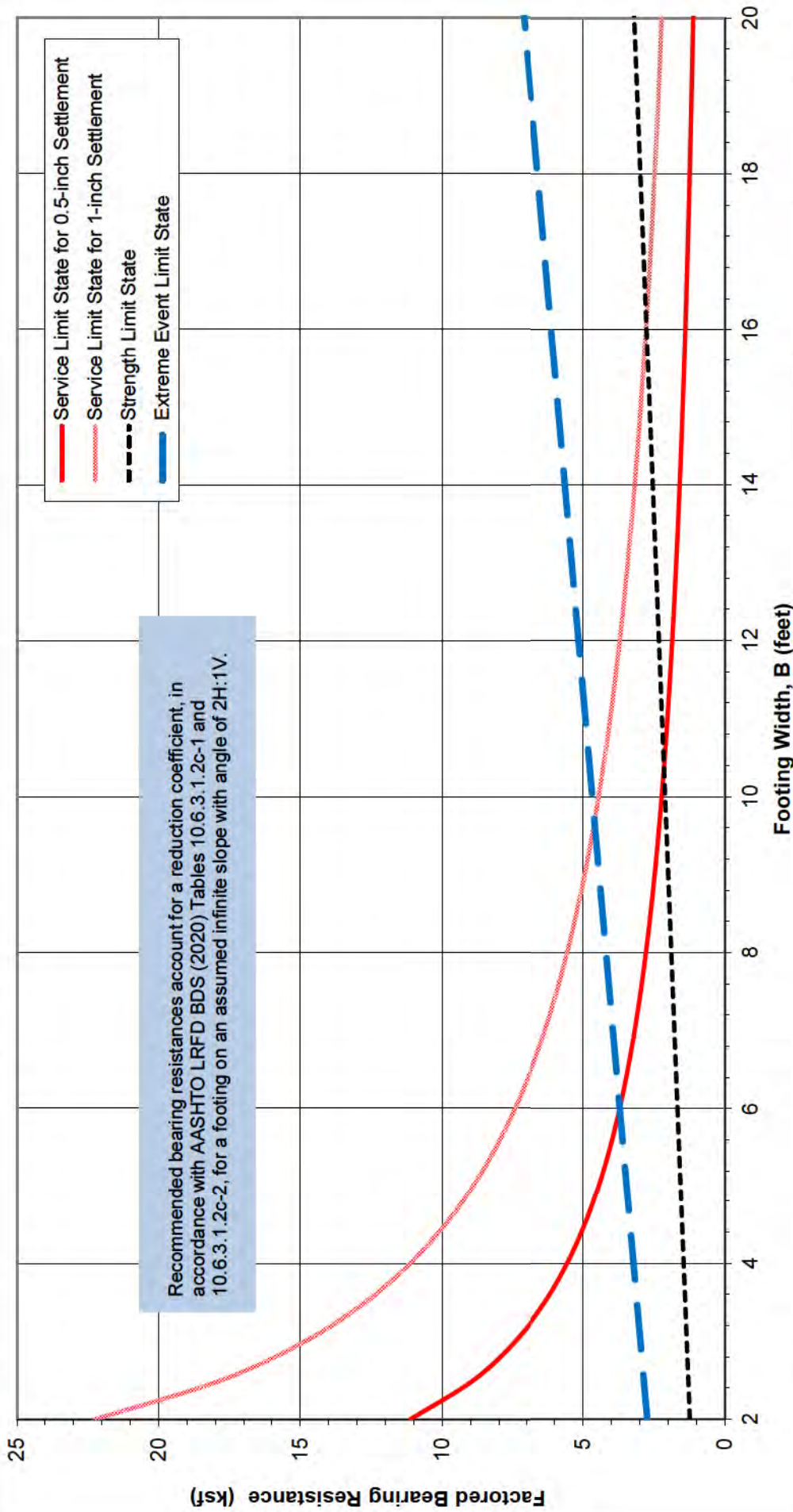

**NOTES**

- We recommend using the following resistance factors for footing LRFD design; the plotted bearing capacities use the bearing capacity resistance factors.
- The factored bearing capacities are based on a soil friction angle of 36 degrees, a soil cohesion of 0 psf, a total unit weight of 130 pcf, a Poisson's ratio of 0.35, and a soil elastic modulus of 2,000 ksf. Our analyses assume that the bottom of the footing is 2 feet below the ground surface.
- psf - pounds per square foot; pcf - pounds per cubic foot; ksf - kips per square foot (1 kip = 1,000 pounds)

Limit State	Sliding Shear	Passive Press.	Bearing Capacity
Service Strength	N/A	N/A	1.0
Extreme Event	0.8	0.5	0.45
	1.0	1.0	1.0

Carkeek Park Pedestrian Bridge  
Replacement Feasibility Study  
Seattle, WA

**FACTORED BEARING RESISTANCE  
VERSUS FOOTING WIDTH  
RECTANGULAR FOOTING, L/B = 1  
PARKING AREA-SIDE (LARGE FOOTING)**

March 2021 SEA-105937

**SHANNON & WILSON, INC.**  
Geotechnical and Environmental Consultants

**FIG. 8**

**FIG. 8**



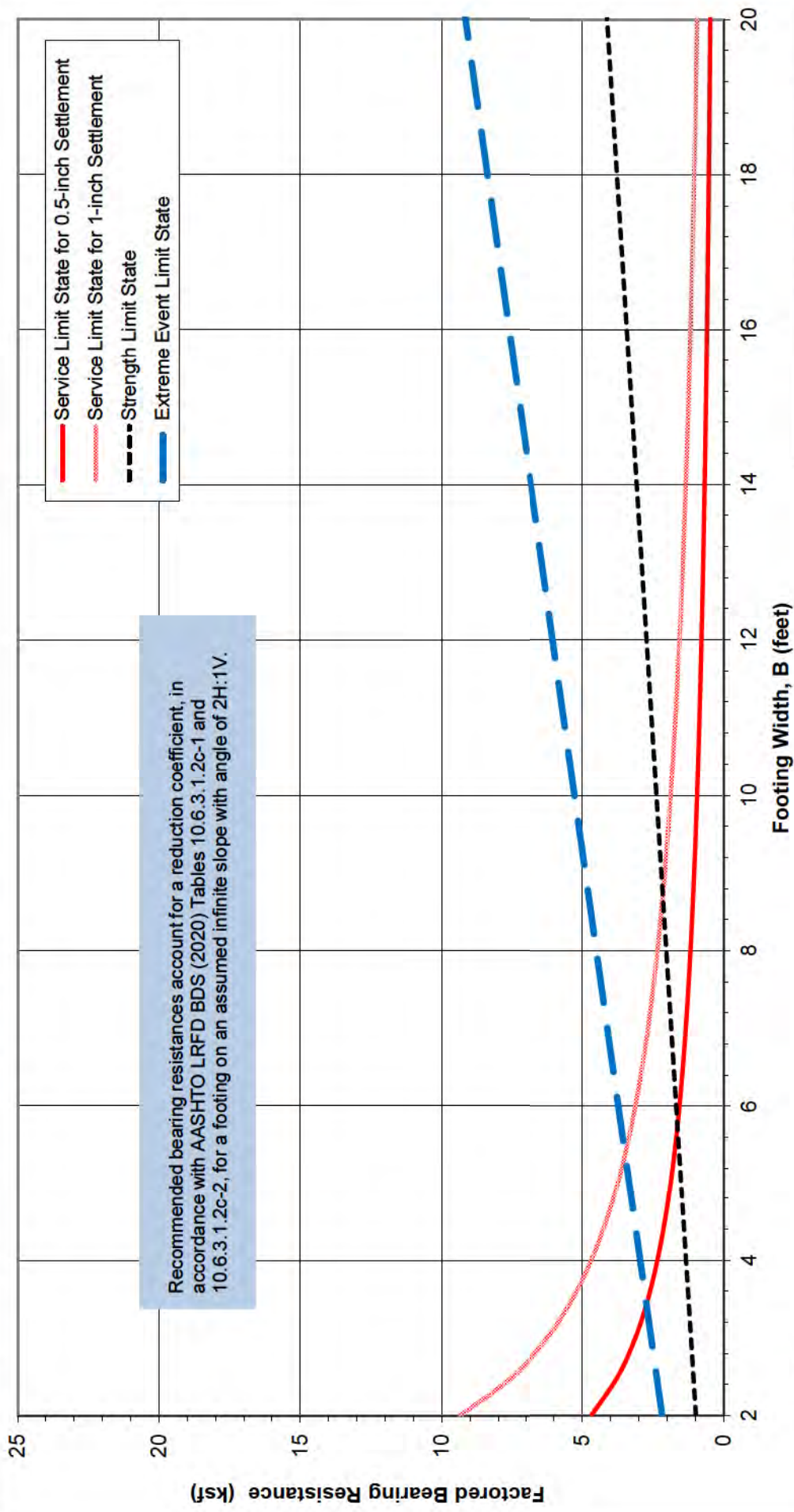

Recommended bearing resistances account for a reduction coefficient, in accordance with AASHTO LRFD BDS (2020) Tables 10.6.3.1.2c-1 and 10.6.3.1.2c-2, for a footing on an assumed infinite slope with angle of 2H:1V.

— Service Limit State for 0.5-inch Settlement  
- - - Service Limit State for 1-inch Settlement  
- - - Strength Limit State  
- - - Extreme Event Limit State

**NOTES**

- We recommend using the following resistance factors for footing LRFD design; the plotted bearing capacities use the bearing capacity resistance factors.
- The factored bearing capacities are based on a soil friction angle of 36 degrees, a soil cohesion of 0 psf, a total unit weight of 130 pcf, a Poisson's ratio of 0.35, and a soil elastic modulus of 2,000 ksf. Our analyses assume that the bottom of the footing is 2 feet below the ground surface.
- psf - pounds per square foot; pcf - pounds per cubic foot; ksf - kips per square foot (1 kip = 1,000 pounds)

Limit State	Sliding Shear	Passive Press.	Bearing Capacity
Service Strength	N/A	N/A	1.0
Extreme Event	0.8	0.5	0.45
	1.0	1.0	1.0

Carkeek Park Pedestrian Bridge  
Replacement Feasibility Study  
Seattle, WA

**FACTORED BEARING RESISTANCE  
VERSUS FOOTING WIDTH  
RECTANGULAR FOOTING, L/B = 10  
PARKING AREA-SIDE (LARGE FOOTING)**

March 2021 SEA-105937

**SHANNON & WILSON, INC.**  
Geotechnical and Environmental Consultants

**FIG. 9**

**FIG. 9**

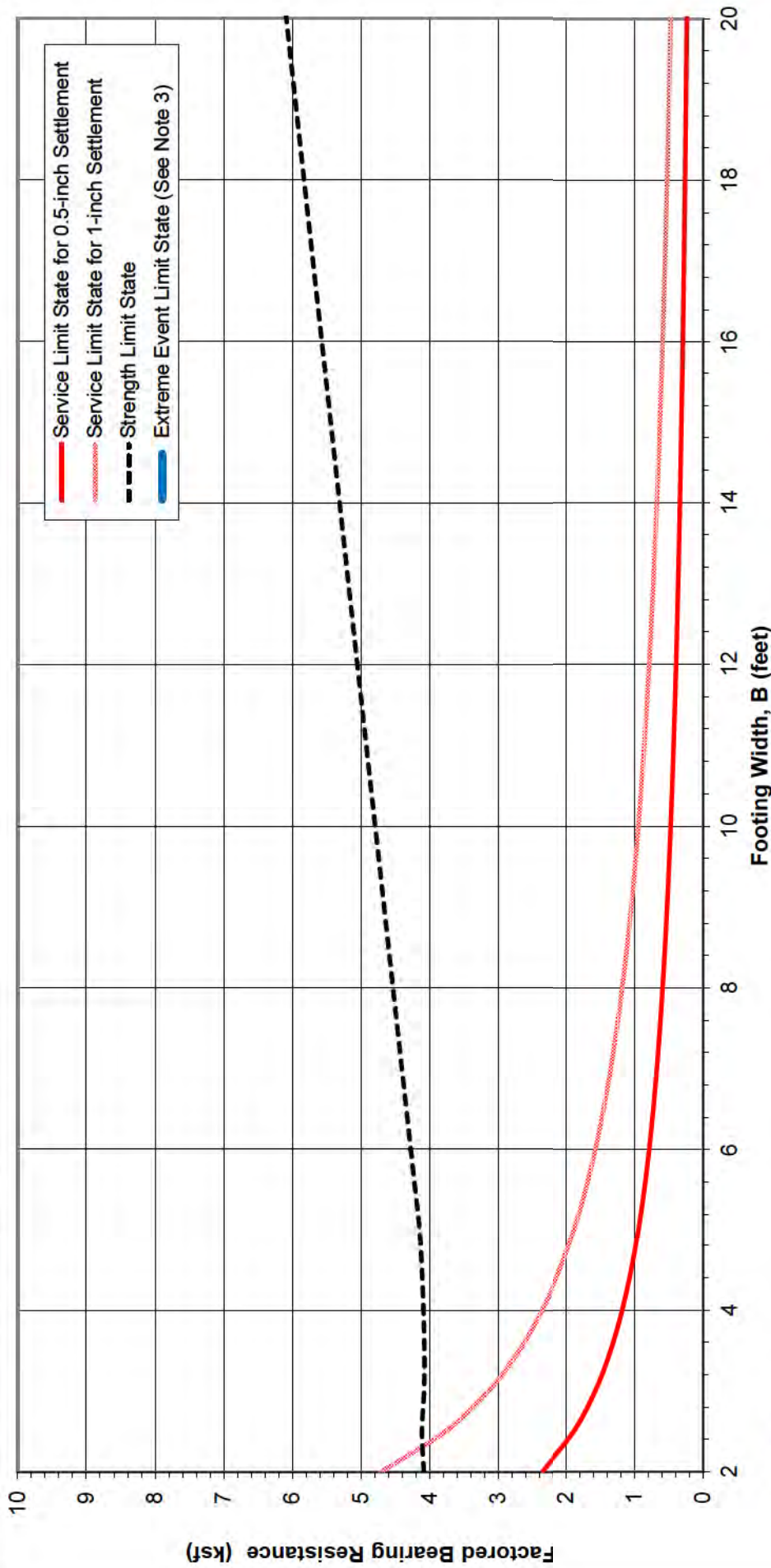

**NOTES**

- We recommend using the following resistance factors for footing LRFD design; the plotted bearing capacities use the bearing capacity resistance factors.
- | Limit State      | Sliding Shear | Passive Press. | Bearing Capacity |
|------------------|---------------|----------------|------------------|
| Service Strength | N/A           | N/A            | 1.0              |
| Extreme Event    | 0.8           | 0.5            | 0.45             |
|                  | See Note 3    | See Note 3     | See Note 3       |
- The factored bearing capacities are based on a soil friction angle of 28 degrees, a soil cohesion of 0 psf, a total unit weight of 115 pcf, a Poisson's ratio of 0.25, and a soil elastic modulus of 100 ksf. Our analyses assume that the bottom of the footing is 5 feet below the ground surface.
  - During the design 1,000-year ground motion, we assume the bearing soil will liquefy, resulting in significant loss of bearing resistance and liquefaction-induced vertical and horizontal displacements.
  - psf - pounds per square foot; pcf - pounds per cubic foot; ksf - kips per square foot (1 kip = 1,000 pounds)

**FIG. 10**

Carkeek Park Pedestrian Bridge  
Replacement Feasibility Study  
Seattle, WA

**FACTORED BEARING RESISTANCE  
VERSUS FOOTING WIDTH  
RECTANGULAR FOOTING, L/B = 1  
SHORE-SIDE**

March 2021

SEA-105937

**SHANNON & WILSON, INC.**  
Geotechnical and Environmental Consultants

**FIG. 10**



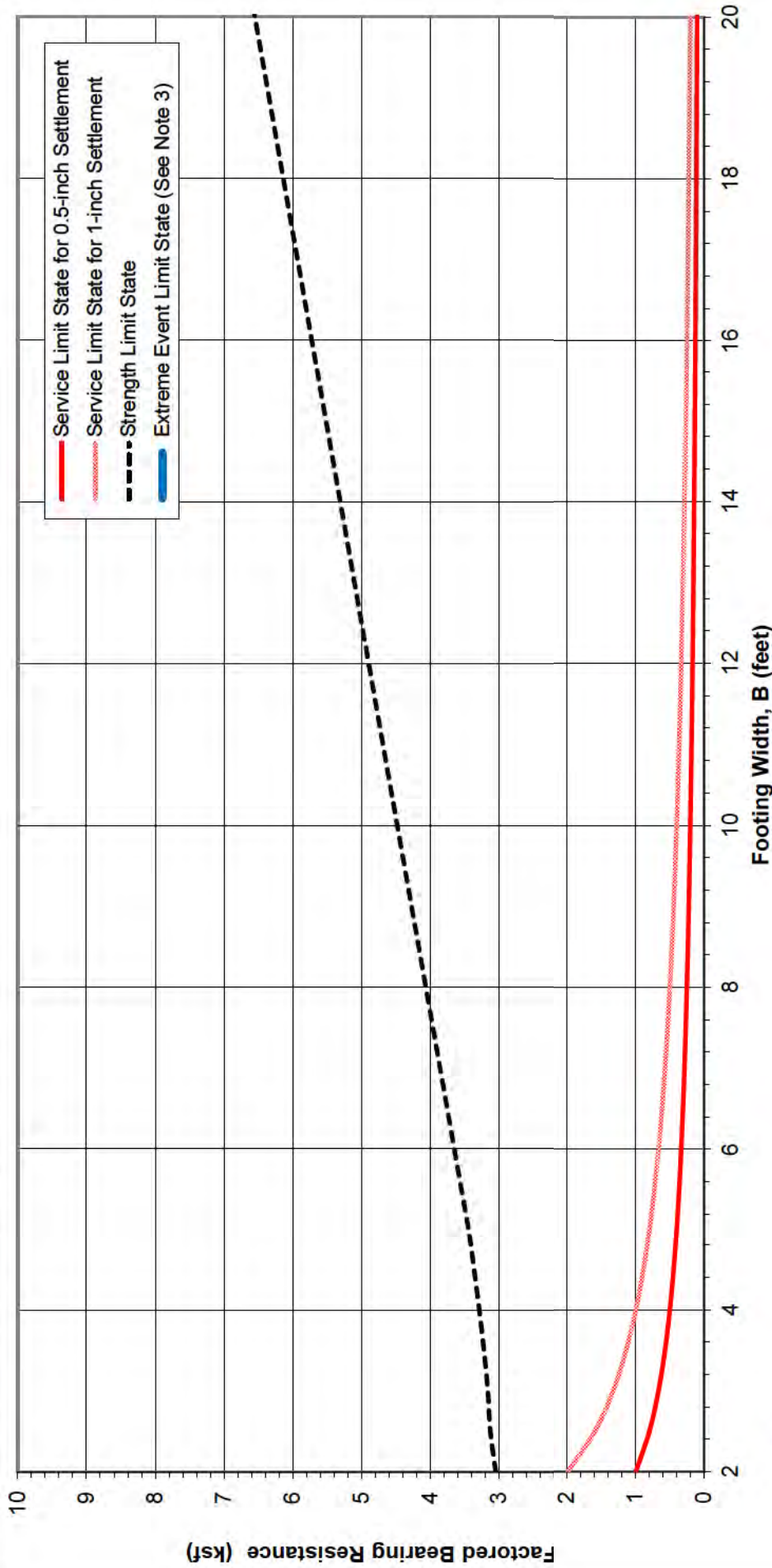

**NOTES**

- We recommend using the following resistance factors for footing LRFD design; the plotted bearing capacities use the bearing capacity resistance factors.
- | Limit State      | Sliding Shear | Passive Press. | Bearing Capacity |
|------------------|---------------|----------------|------------------|
| Service Strength | N/A           | N/A            | 1.0              |
| Extreme Event    | 0.8           | 0.5            | 0.45             |
|                  | See Note 3    | See Note 3     | See Note 3       |
- The factored bearing capacities are based on a soil friction angle of 28 degrees, a soil cohesion of 0 psf, a total unit weight of 115 pcf, a Poisson's ratio of 0.25, and a soil elastic modulus of 100 ksf. Our analyses assume that the bottom of the footing is 5 feet below the ground surface.
  - During the design 1,000-year ground motion, we assume the bearing soil will liquefy, resulting in significant loss of bearing resistance and liquefaction-induced vertical and horizontal displacements.
  - psf - pounds per square foot; pcf - pounds per cubic foot; ksf - kips per square foot (1 kip = 1,000 pounds)

**FIG. 11**

Carkeek Park Pedestrian Bridge  
Replacement Feasibility Study  
Seattle, WA

**FACTORED BEARING RESISTANCE  
VERSUS FOOTING WIDTH  
RECTANGULAR FOOTING, L/B = 10  
SHORE-SIDE**

March 2021

SEA-105937

**SHANNON & WILSON, INC.**  
Geotechnical and Environmental Consultants

**FIG. 11**

**GENERALIZED SUBSURFACE PROFILE**

Based on Nearby Explorations:  
B-4 (2020)

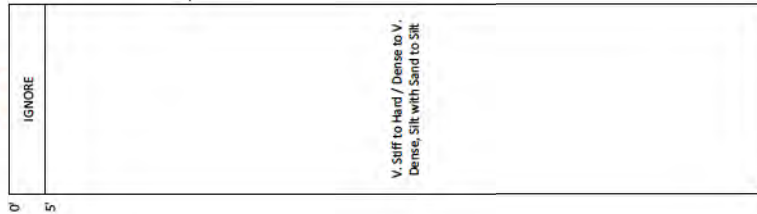

**STRENGTH LIMIT STATE**

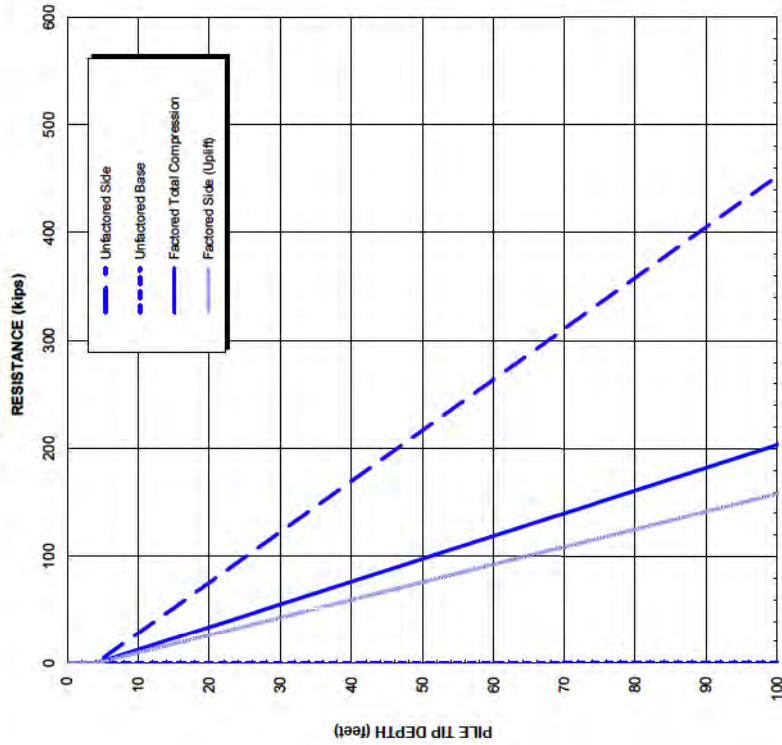

**STRENGTH LIMIT STATE NOTES:**

1. Recommended resistance factors are 0.45 and 0.45 for side and base resistances, respectively. See general note 3 below.
2. Recommended resistance factor for uplift is 0.5.

**EXTREME EVENT LIMIT STATE**

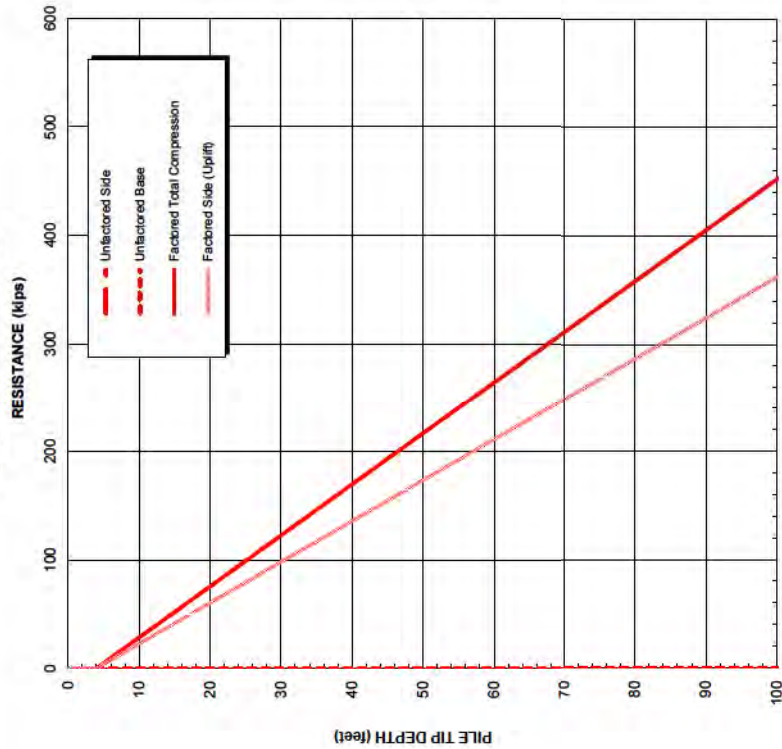

**EXTREME EVENT LIMIT STATE NOTES:**

1. Recommended resistance factors are 1.0 for both side and base resistance, and 0.8 for uplift.
2. Unfactored downward force is estimated to be 0 kips. Per the WSDOT GDM, a load factor of 1.25 is recommended to determine factored downward force. Downward force is recommended to be applied with post-earthquake loading.

**GENERAL NOTES:**

1. The analyses were performed based on guidelines included in the AASHTO LRFD Bridge Design Specifications (AASHTO), the WSDOT Geotechnical Design Manual (GDM), and local experience. The analyses are based on a single pile and do not consider group action of closely spaced piles (closer than 30 inches or 3.0 diameters, center to center, whichever is greater).
2. Factored total compression pile resistance shown on plots is determined by adding its unfactored side and base resistances multiplied by the appropriate resistance factors as noted above.
3. Recommended resistance factors for the strength limit state are intended to be used with the Shannon & Wilson pile design method. These resistance factors are based upon substantial successful application of the Shannon & Wilson pile design method in the Pacific Northwest. They are not calibrated to a specific reliability index.
4. Contribution to axial resistance within the upper 5 feet of the pile is ignored to account for disturbance during construction.

Carkeek Park Pedestrian Bridge  
Replacement Feasibility Study  
Seattle, WA

---

**ESTIMATED AXIAL RESISTANCE**  
**9-IN-DIAM MICROPILE**  
**PARKING AREA-SIDE (EAST OF RAIL)**

March 2021      SEA-105937

---

**SHANNON & WILSON, INC.**  
A SHANNON & WILSON COMPANY

**FIG. 12**



**GENERALIZED SUBSURFACE PROFILE**

Based on Nearby Explorations:  
TB-19 (1972)



**STRENGTH LIMIT STATE**

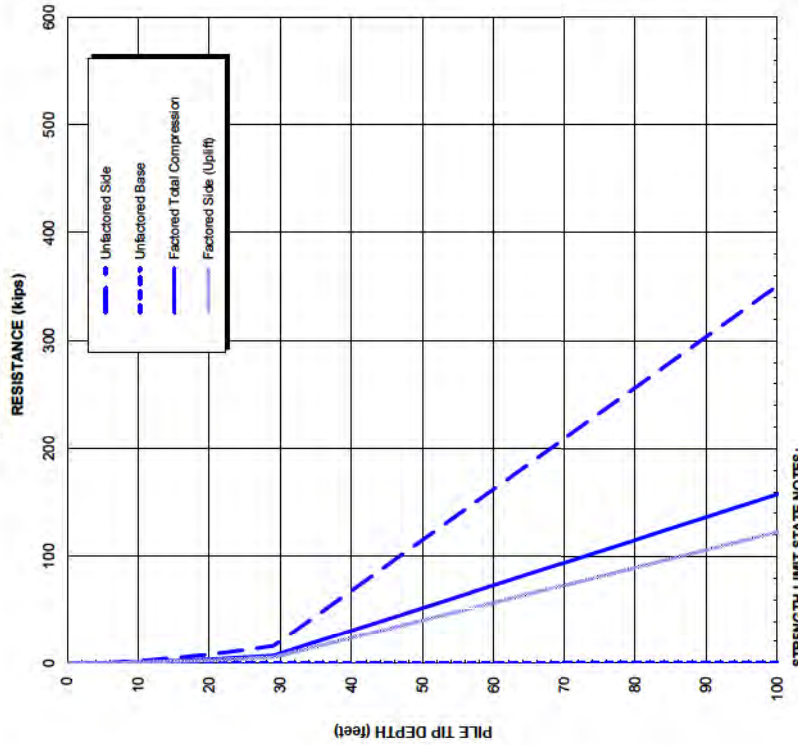

**STRENGTH LIMIT STATE NOTES:**

1. Recommended resistance factors are 0.45 and 0.45 for side and base resistances, respectively. See general note 3 below.
2. Recommended resistance factor for uplift is 0.5.

**EXTREME EVENT LIMIT STATE**

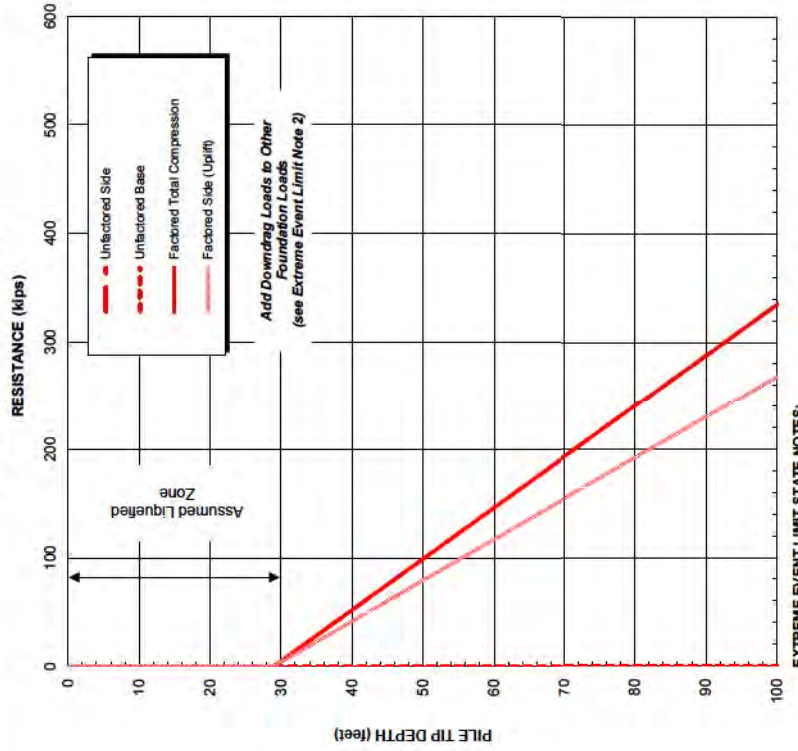

**EXTREME EVENT LIMIT STATE NOTES:**

1. Recommended resistance factors are 1.0 for both side and base resistance, and 0.8 for uplift.
2. Unfactored downdrag force is estimated to be 20 kips. Per the WSDOT GDM, a load factor of 1.25 is recommended to determine factored downdrag force. Downdrag force is recommended to be applied with post-earthquake loading.

**GENERAL NOTES:**

1. The analyses were performed based on guidelines included in the AASHTO LRFD Bridge Design Specifications (AASHTO), the WSDOT Geotechnical Design Manual (GDM), and local experience. The analyses are based on a single pile and do not consider group action of closely spaced piles (closer than 30 inches or 3.0 diameters, center to center, whichever is greater).
2. Factored total compression pile resistance shown on plots is determined by adding its unfactored side and base resistances multiplied by the appropriate resistance factors as noted above.
3. Recommended resistance factors for the strength limit state are intended to be used with the Shannon & Wilson pile design method. These resistance factors are based upon substantial successful application of the Shannon & Wilson pile design method in the Pacific Northwest. They are not calibrated to a specific reliability index.
4. Contribution to axial resistance within the upper 5 feet of the pile is ignored to account for disturbance during construction.

Carkeek Park Pedestrian Bridge  
Replacement Feasibility Study  
Seattle, WA

ESTIMATED AXIAL RESISTANCE  
9-IN-DIAM MICROPILE  
SHORE-SIDE (WEST OF RAIL)  
LIQUEFACTION TO 30 FEET

March 2021 SEA-105937



SHANNON & WILSON, INC.

FIG. 13

**GENERALIZED SUBSURFACE PROFILE**

Based on Nearby Explorations:  
TB-19 (1972)

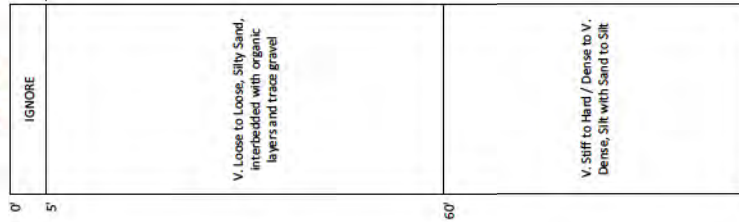

**STRENGTH LIMIT STATE**

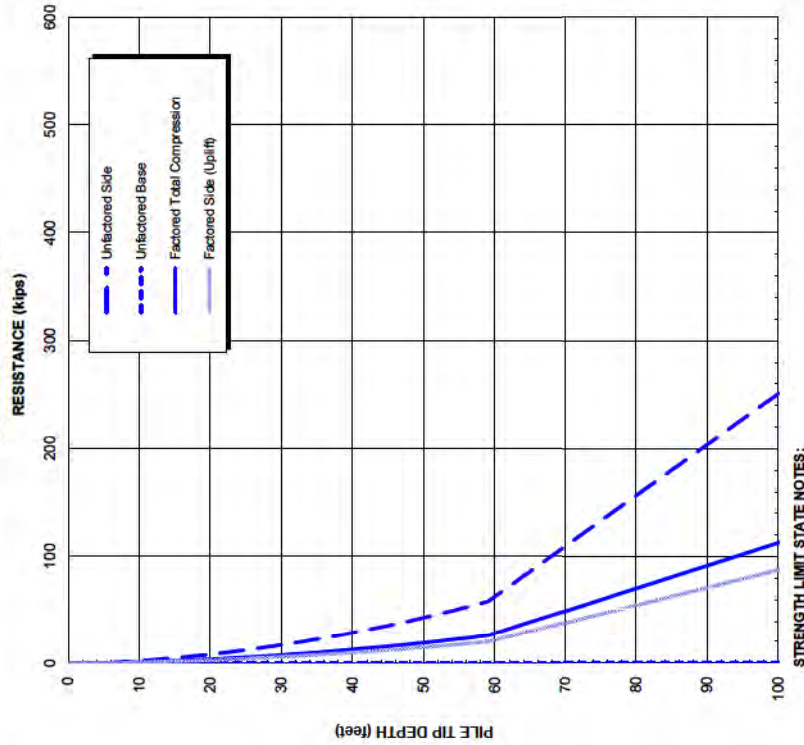

**STRENGTH LIMIT STATE NOTES:**

1. Recommended resistance factors are 0.45 and 0.45 for side and base resistances, respectively. See general note 3 below.
2. Recommended resistance factor for uplift is 0.5.

**EXTREME EVENT LIMIT STATE**

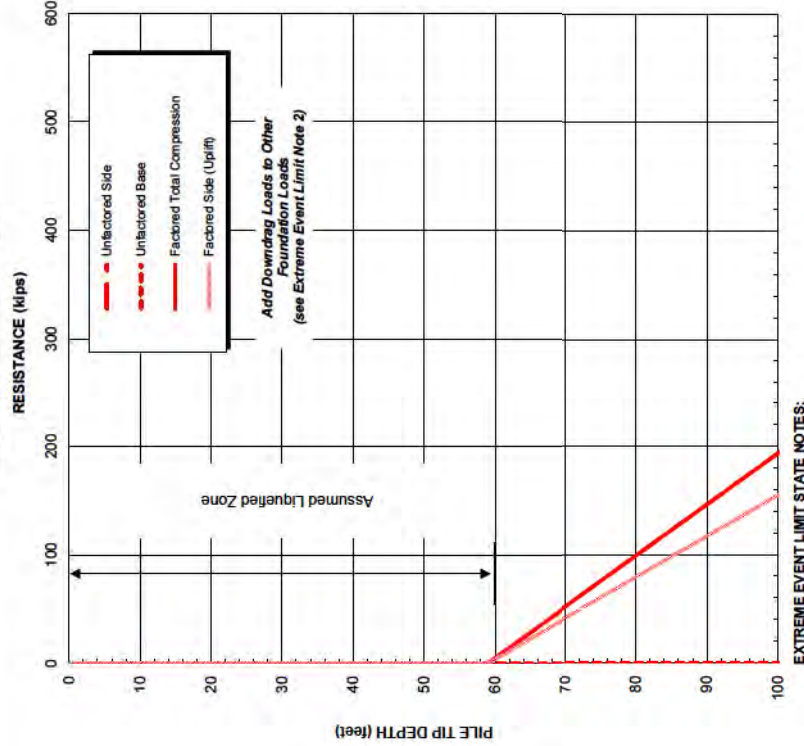

**EXTREME EVENT LIMIT STATE NOTES:**

1. Recommended resistance factors are 1.0 for both side and base resistance, and 0.8 for uplift.
2. Unfactored downdrag force is estimated to be 60 kips. Per the WSDOT GDM, a load factor of 1.25 is recommended to determine factored downdrag force. Downdrag force is recommended to be applied with post-earthquake loading.

**GENERAL NOTES:**

1. The analyses were performed based on guidelines included in the AASHTO LRFD Bridge Design Specifications (AASHTO), the WSDOT Geotechnical Design Manual (GDM), and local experience. The analyses are based on a single pile and do not consider group action of closely spaced piles (closer than 30 inches or 3.0 diameters, center to center, whichever is greater).
2. Factored total compression pile resistance shown on plots is determined by adding its unfactored side and base resistances multiplied by the appropriate resistance factors as noted above.
3. Recommended resistance factors for the strength limit state are intended to be used with the Shannon & Wilson pile design method. These resistance factors are based upon substantial successful application of the Shannon & Wilson pile design method in the Pacific Northwest. They are not calibrated to a specific reliability index.
4. Contribution to axial resistance within the upper 5 feet of the pile is ignored to account for disturbance during construction.

Carkeek Park Pedestrian Bridge  
Replacement Feasibility Study  
Seattle, WA

ESTIMATED AXIAL RESISTANCE  
9-IN-DIAM MICROPILE  
SHORE-SIDE (WEST OF RAIL)  
LIQUEFACTION TO 60 FEET  
March 2021 SEA-105937



SHANNON & WILSON, INC.

FIG. 14



**GENERALIZED SUBSURFACE PROFILE**

Based on *Nearby Explorations B-4 (2020)*

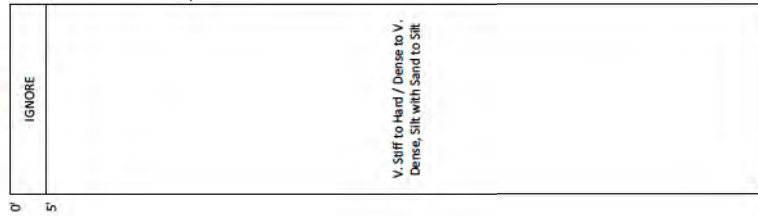

**STRENGTH LIMIT STATE**

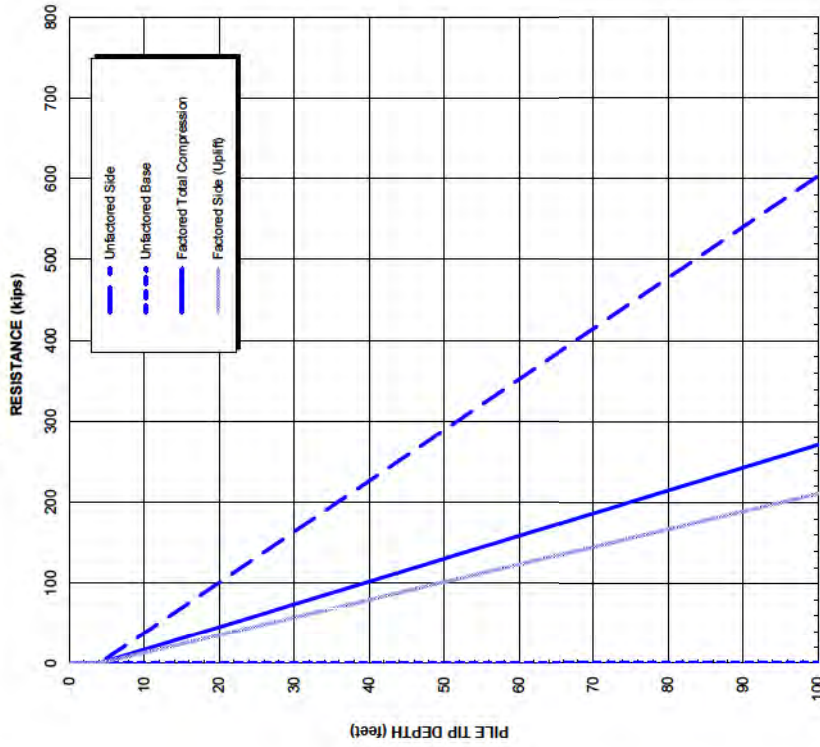

**STRENGTH LIMIT STATE NOTES:**

1. Recommended resistance factors are 0.45 and 0.45 for side and base resistance, respectively. See general note 3 below.
2. Recommended resistance factor for uplift is 0.5.

**EXTREME EVENT LIMIT STATE**

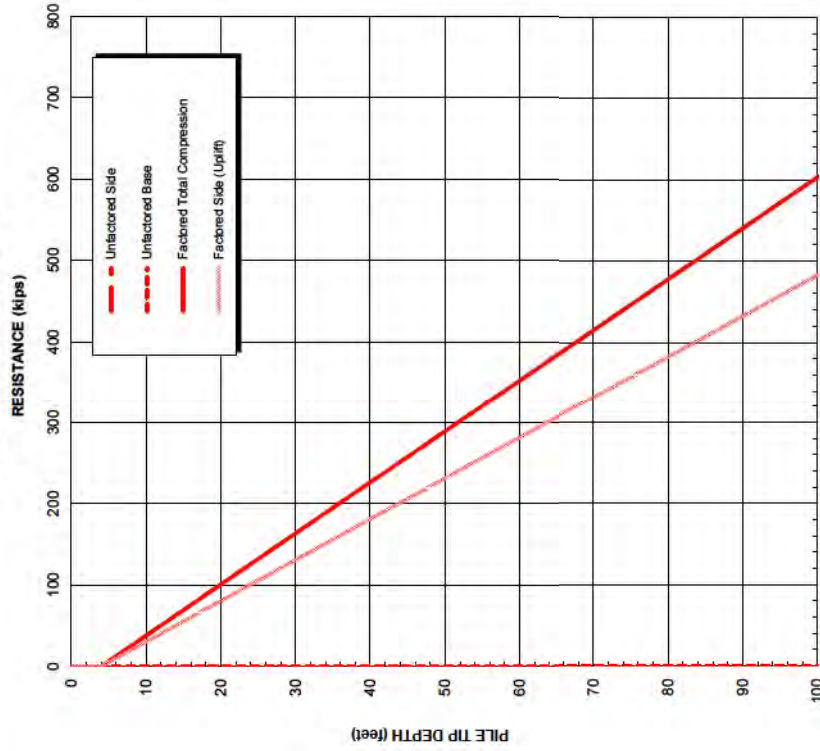

**EXTREME EVENT LIMIT STATE NOTES:**

1. Recommended resistance factors are 1.0 for both side and base resistance, and 0.8 for uplift.
2. Unfactored downward force is estimated to be 0 kips. Per the WSDOT GDM, a load factor of 1.25 is recommended to determine factored downward force. Downward force is recommended to be applied with post-earthquake loading.

**GENERAL NOTES:**

1. The analyses were performed based on guidelines included in the AASHTO LRPD Bridge Design Specifications (AASHTO), the WSDOT Geotechnical Design Manual (GDM), and local experience. The analyses are based on a single pile and do not consider group action of closely spaced piles (closer than 30 inches or 3.0 diameters, center to center, whichever is greater).
2. Factored total compression pile resistance shown on plots is determined by adding its unfactored side and base resistances multiplied by the appropriate resistance factors as noted above.
3. Recommended resistance factors for the strength limit state are intended to be used with the Shannon & Wilson pile design method. These resistance factors are based upon substantial successful application of the Shannon & Wilson pile design method in the Pacific Northwest. They are not calibrated to a specific reliability index.
4. Contribution to axial resistance within the upper 5 feet of the pile is ignored to account for disturbance during construction.

Carkeek Park Pedestrian Bridge  
Replacement Feasibility Study  
Seattle, WA

ESTIMATED AXIAL RESISTANCE  
12-IN-DIAM MICROPILE  
PARKING AREA-SIDE (EAST OF RAIL)

March 2021 SEA-105937

SHANNON & WILSON, INC.

FIG. 15

**GENERALIZED SUBSURFACE PROFILE**

Based on *Nearby Explorations*  
TB-19 (1972)

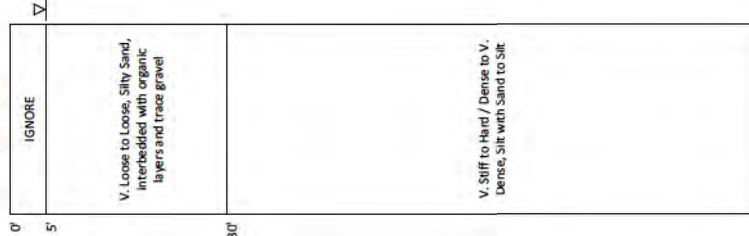

**STRENGTH LIMIT STATE**

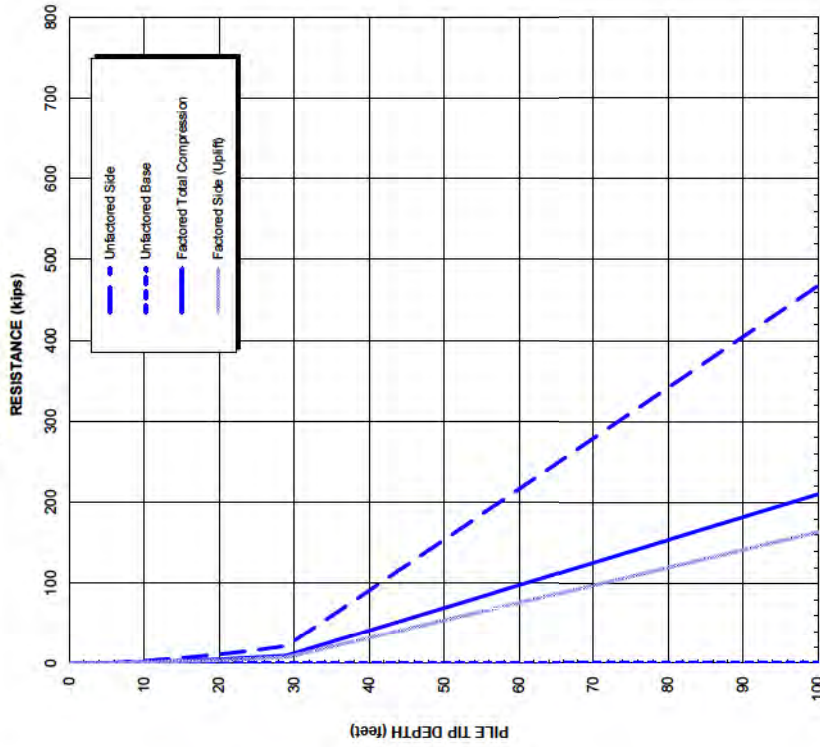

**STRENGTH LIMIT STATE NOTES:**

1. Recommended resistance factors are 0.45 and 0.45 for side and base resistance, respectively. See general note 3 below.
2. Recommended resistance factor for uplift is 0.5.

**EXTREME EVENT LIMIT STATE**

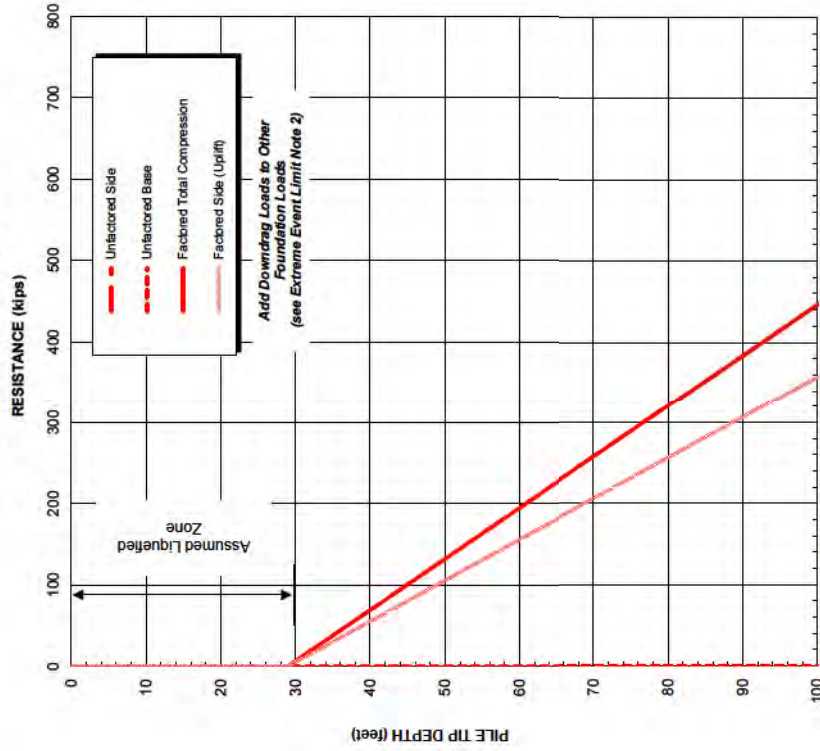

**EXTREME EVENT LIMIT STATE NOTES:**

1. Recommended resistance factors are 1.0 for both side and base resistance, and 0.8 for uplift.
2. Unfactored downdrag force is estimated to be 20 kips. Per the WSDOT GDM, a load factor of 1.25 is recommended to determine factored downdrag force. Downdrag force is recommended to be applied with post-earthquake loading.

**GENERAL NOTES:**

1. The analyses were performed based on guidelines included in the AASHTO LRPD Bridge Design Specifications (AASHTO), the WSDOT Geotechnical Design Manual (GDM), and local experience. The analyses are based on a single pile and do not consider group action of closely spaced piles (closer than 30 inches or 3.0 diameters, center to center, whichever is greater).
2. Factored total compression pile resistance shown on plots is determined by adding its unfactored side and base resistances multiplied by the appropriate resistance factors as noted above.
3. Recommended resistance factors for the strength limit state are intended to be used with the Shannon & Wilson pile design method. These resistance factors are based upon substantial successful application of the Shannon & Wilson pile design method in the Pacific Northwest. They are not calibrated to a specific reliability index.
4. Contribution to axial resistance within the upper 5 feet of the pile is ignored to account for disturbance during construction.

Carkeek Park Pedestrian Bridge  
Replacement Feasibility Study  
Seattle, WA

ESTIMATED AXIAL RESISTANCE  
12-IN-DIAM MICROPILE  
SHORE-SIDE (WEST OF RAIL)  
LIQUEFACTION TO 30 FEET

March 2021 SEA-105937

SHANNON & WILSON, INC.

FIG. 16



**GENERALIZED SUBSURFACE PROFILE**

Based on Nearby Explorations  
TB-19 (1972)

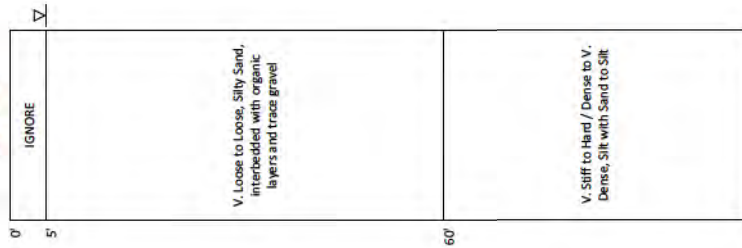

**STRENGTH LIMIT STATE**

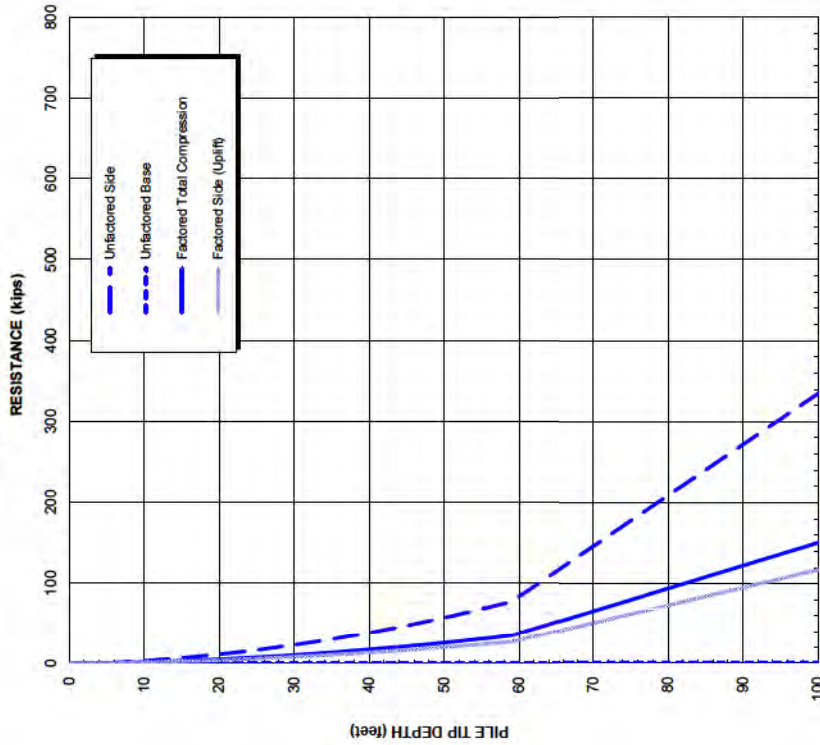

**STRENGTH LIMIT STATE NOTES:**

1. Recommended resistance factors are 0.45 and 0.45 for side and base resistance, respectively. See general note 3 below.
2. Recommended resistance factor for uplift is 0.5.

**EXTREME EVENT LIMIT STATE**

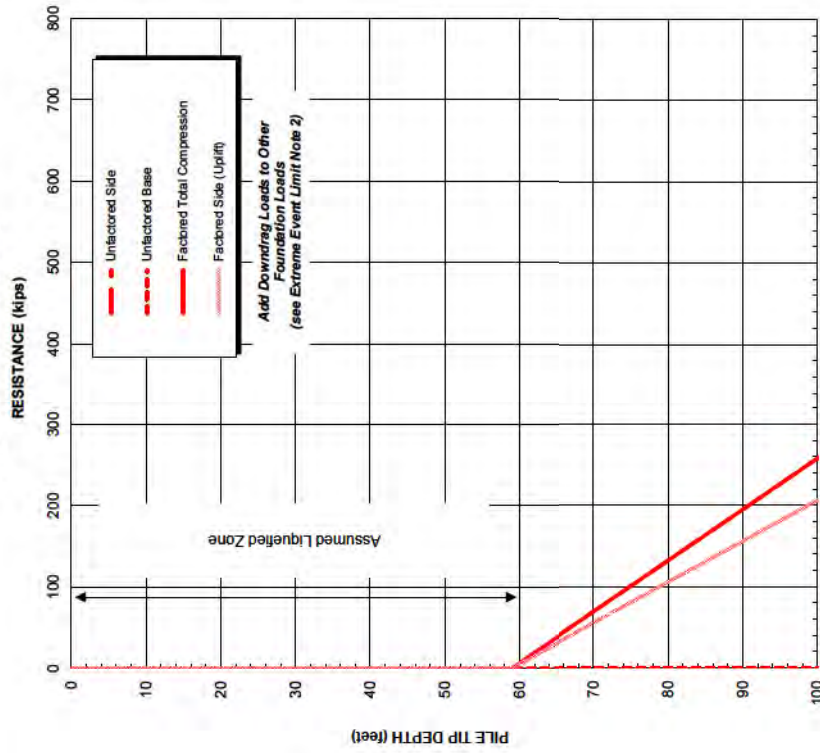

**EXTREME EVENT LIMIT STATE NOTES:**

1. Recommended resistance factors are 1.0 for both side and base resistance, and 0.8 for uplift.
2. Unfactored downdrag force is estimated to be 80 kips. Per the WSDOT GDM, a load factor of 1.25 is recommended to determine factored downdrag force. Downdrag force is recommended to be applied with post-earthquake loading.

**GENERAL NOTES:**

1. The analyses were performed based on guidelines included in the AASHTO LRPD Bridge Design Specifications (AASHTO), the WSDOT Geotechnical Design Manual (GDM), and local experience. The analyses are based on a single pile and do not consider group action of closely spaced piles (closer than 30 inches or 3.0 diameters, center to center, whichever is greater).
2. Factored total compression pile resistance shown on plots is determined by adding its unfactored side and base resistances multiplied by the appropriate resistance factors as noted above.
3. Recommended resistance factors for the strength limit state are intended to be used with the Shannon & Wilson pile design method. These resistance factors are based upon substantial successful application of the Shannon & Wilson pile design method in the Pacific Northwest. They are not calibrated to a specific reliability index.
4. Contribution to axial resistance within the upper 5 feet of the pile is ignored to account for disturbance during construction.

Carkeek Park Pedestrian Bridge  
Replacement Feasibility Study  
Seattle, WA

ESTIMATED AXIAL RESISTANCE  
12-IN-DIAM MICROPILE  
SHORE-SIDE (WEST OF RAIL)  
LIQUEFACTION TO 60 FEET

March 2021 SEA-105937

SHANNON & WILSON, INC.

FIG. 17

**ASSUMED SUBSURFACE PROFILE**

Based on Nearby Explorations:  
B-4 (2020)

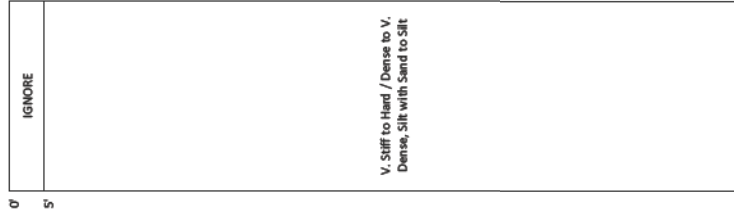

**SERVICE LIMIT STATE**

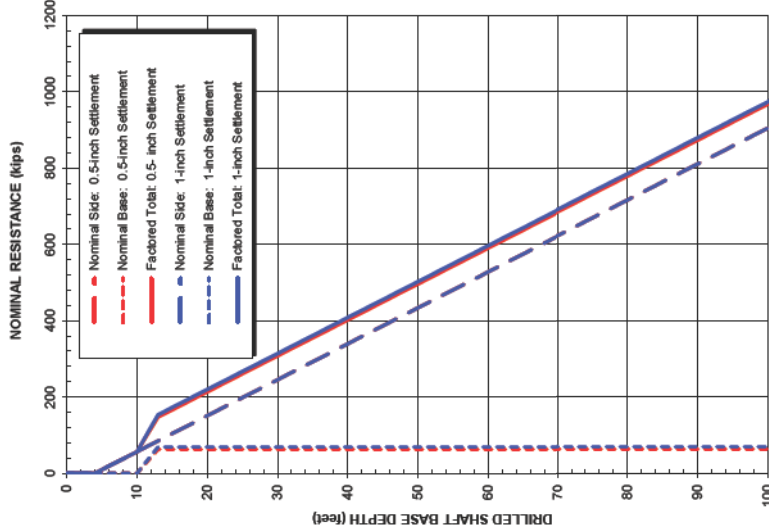

**SERVICE LIMIT STATE NOTES:**

1. Recommended resistance factors per AASHTO are 1.0 for both side and base resistance.
2. Settlement is based on a single shaft. No group action is considered.

**STRENGTH LIMIT STATE**

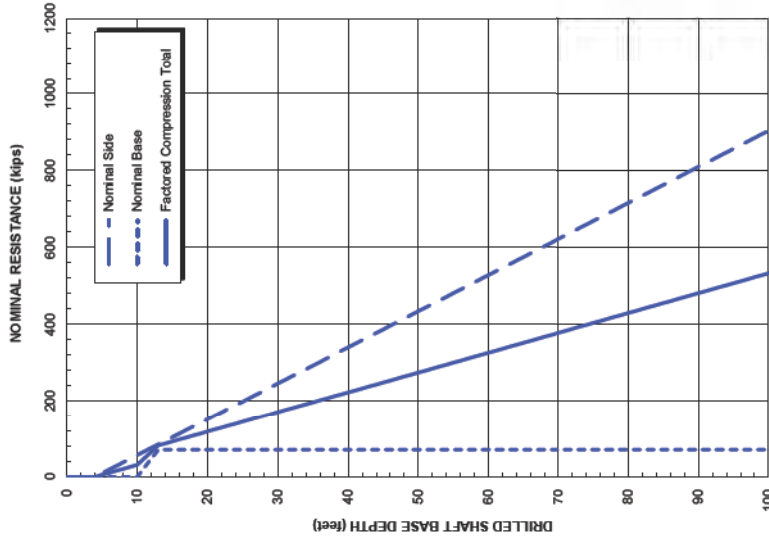

**STRENGTH LIMIT STATE NOTES:**

1. Recommended compression resistance factors per AASHTO are 0.55 and 0.5 for side and base resistance, respectively.
2. Shaft uplift resistance can be estimated by using the nominal side resistance shown above and a recommended resistance factor of 0.35 (per AASHTO).
3. For non-redundant shafts, where a pier/column is supported on a single shaft, the resistance factors are reduced by 20% (per AASHTO).

**EXTREME EVENT LIMIT STATE**

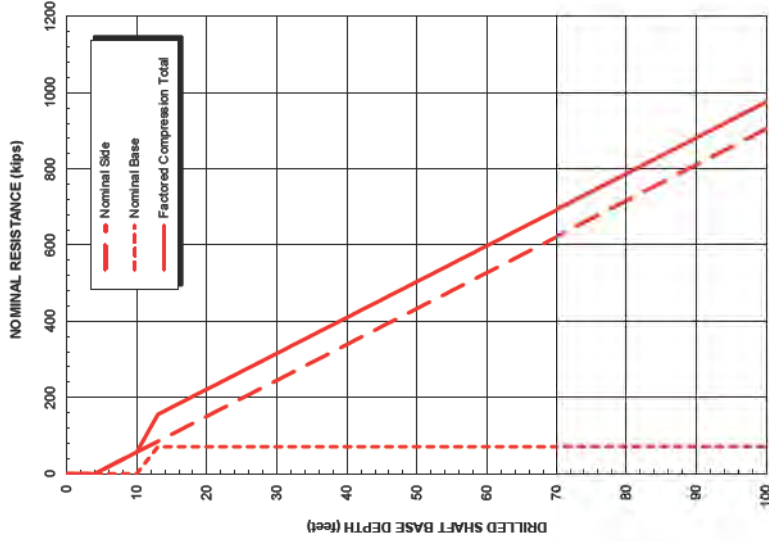

**EXTREME EVENT LIMIT STATE NOTES:**

1. Recommended resistance factors per AASHTO for both side and base resistance are 1.0 for compression and 0.8 for uplift.
2. Unfactored downdrag force is estimated to be 0 kips. Per AASHTO, a load factor of 1.25 is recommended to determine factored downdrag force. Downdrag force is recommended to be applied with positive earthquake loading.

**GENERAL NOTES**

1. The analyses were performed based on guidelines included in the AASHTO LRFD Bridge Design Specifications (AASHTO), the WSDOT Geotechnical Design Manual (GDM), and local experience. The analyses are based on a single shaft and do not consider group action of closely spaced shafts (closer than 4 diameters, center to center).
2. Factored total shaft resistance shown on plots is determined by adding its nominal side and base resistance multiplied by the appropriate resistance factors as noted above.
3. Estimated shaft resistance assumes that if casing is used, it will be removed after the shaft installation. If, however, the casing is left in place, grouting should be used to fill all potential voids around the casing and the estimated resistance given above should be re-evaluated.
4. Contribution to axial resistance within the upper 5 feet of the pile is ignored to account for disturbance during construction.

Carleek Park Pedestrian Bridge  
Replacement Feasibility Study  
Seattle, WA

ESTIMATED AXIAL RESISTANCE  
1.5-FT-DIAM DRILLED SHAFT  
PARKING AREA-SIDE (EAST OF RAIL)

March 2021 SEA-106937

SHANNON & WILSON, INC.

FIG. 18



**ASSUMED SUBSURFACE PROFILE**

Based on Nearby Explorations:  
TB-19 (1972)

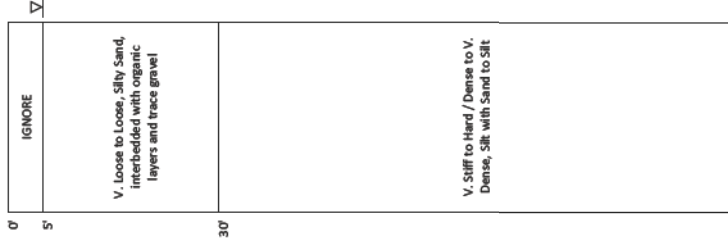

**SERVICE LIMIT STATE**

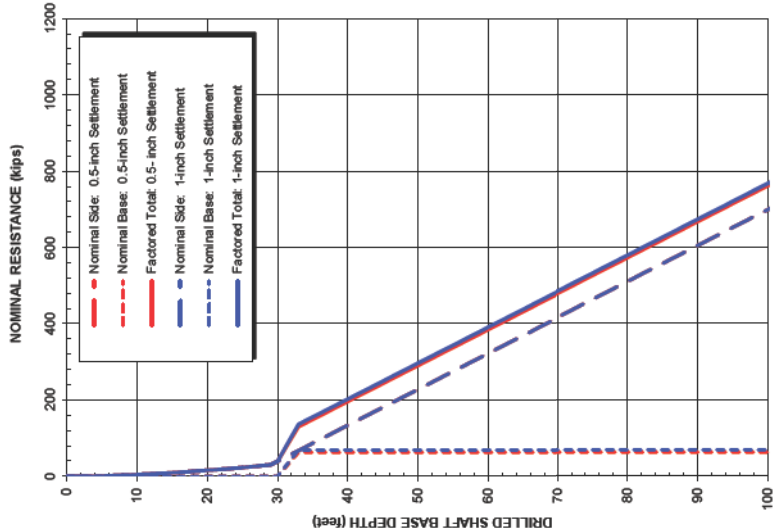

**SERVICE LIMIT STATE NOTES:**

1. Recommended resistance factors per AASHTO are 1.0 for both side and base resistance.
2. Settlement is based on a single shaft. No group action is considered.

**STRENGTH LIMIT STATE**

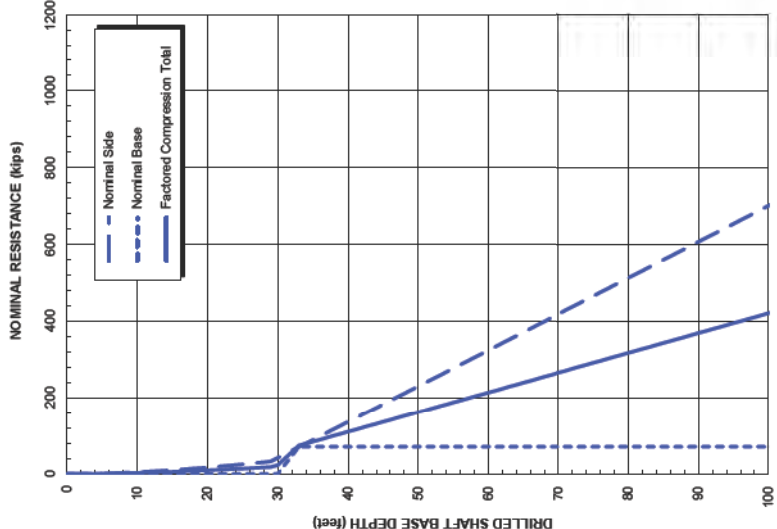

**STRENGTH LIMIT STATE NOTES:**

1. Recommended compression resistance factors per AASHTO are 0.55 and 0.5 for side and base resistance, respectively.
2. Shaft uplift resistance can be estimated by using the nominal side resistance shown above and a recommended resistance factor of 0.35 (per AASHTO).
3. For non-redundant shafts, where a pier/column is supported on a single shaft, the resistance factors are reduced by 20% (per AASHTO).

**EXTREME EVENT LIMIT STATE**

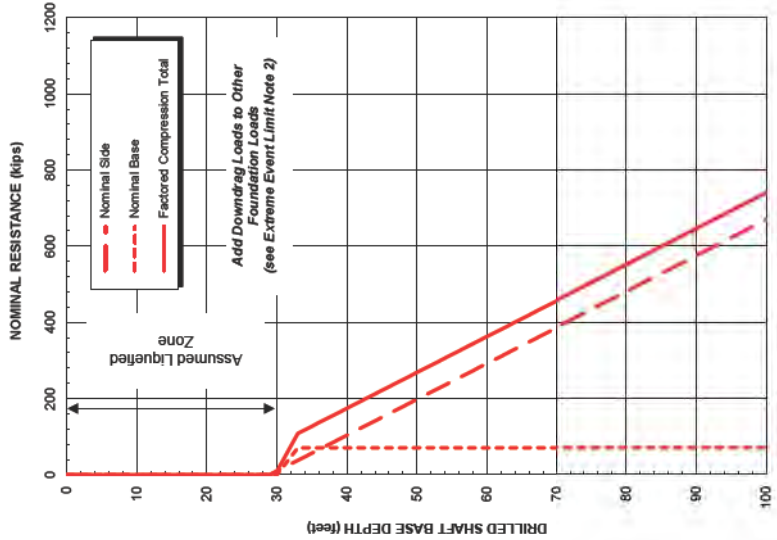

**EXTREME EVENT LIMIT STATE NOTES:**

1. Recommended resistance factors per AASHTO for both side and base resistance are 1.0 for compression and 0.8 for uplift.
2. Unfactored downdrag force is estimated to be 30 kips. Per AASHTO, a load factor of 1.25 is recommended to determine factored downdrag force. Downdrag force is recommended to be applied with post-earthquake loading.

**GENERAL NOTES**

1. The analyses were performed based on guidelines included in the AASHTO LRFD Bridge Design Specifications (AASHTO), the WSDOT Geotechnical Design Manual (GDM), and local experience. The analyses are based on a single shaft and do not consider group action of closely spaced shafts (closer than 4 diameters, center to center).
2. Factored total shaft resistance shown on plots is determined by adding its nominal side and base resistances multiplied by the appropriate resistance factors as noted above.
3. Estimated shaft resistance assumes that if casing is used, it will be removed after the shaft installation. If, however, the casing is left in place, grouting should be used to fill all potential voids around the casing and the estimated resistance given above should be re-evaluated.
4. Contribution to axial resistance within the upper 5 feet of the pile is ignored to account for disturbance during construction.

Carkeek Park Pedestrian Bridge  
Replacement Feasibility Study  
Seattle, WA

**ESTIMATED AXIAL RESISTANCE**  
**1.5-FT-DIAM DRILLED SHAFT**  
**SHORE-SIDE (WEST OF RAIL)**  
**LIQUEFACTION TO 30 FEET**

March 2021  
SEA-106937

SHANNON & WILSON, INC.  
FIG. 19

**ASSUMED SUBSURFACE PROFILE**

Based on Nearby Explorations:  
TB-19 (1972)

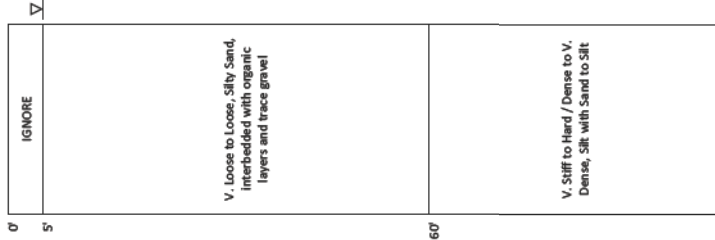

**SERVICE LIMIT STATE**

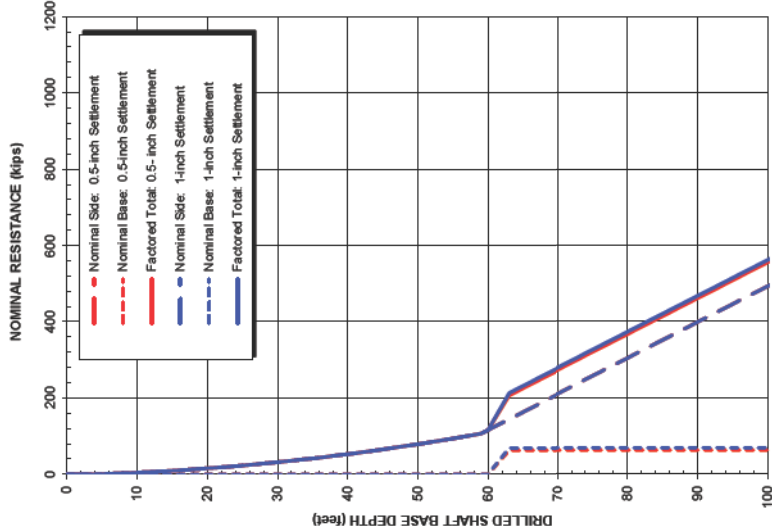

**SERVICE LIMIT STATE NOTES:**

1. Recommended resistance factors per AASHTO are 1.0 for both side and base resistance.
2. Settlement is based on a single shaft. No group action is considered.

**STRENGTH LIMIT STATE**

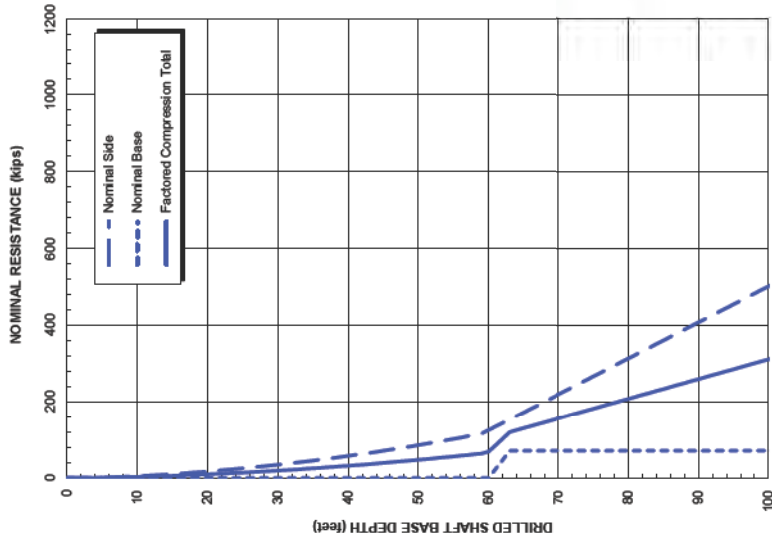

**STRENGTH LIMIT STATE NOTES:**

1. Recommended compression resistance factors per AASHTO are 0.55 and 0.5 for side and base resistance, respectively.
2. Shaft uplift resistance can be estimated by using the nominal side resistance shown above and a recommended resistance factor of 0.35 (per AASHTO).
3. For non-redundant shafts, where a pier/column is supported on a single shaft, the resistance factors are reduced by 20% (per AASHTO).

**EXTREME EVENT LIMIT STATE**

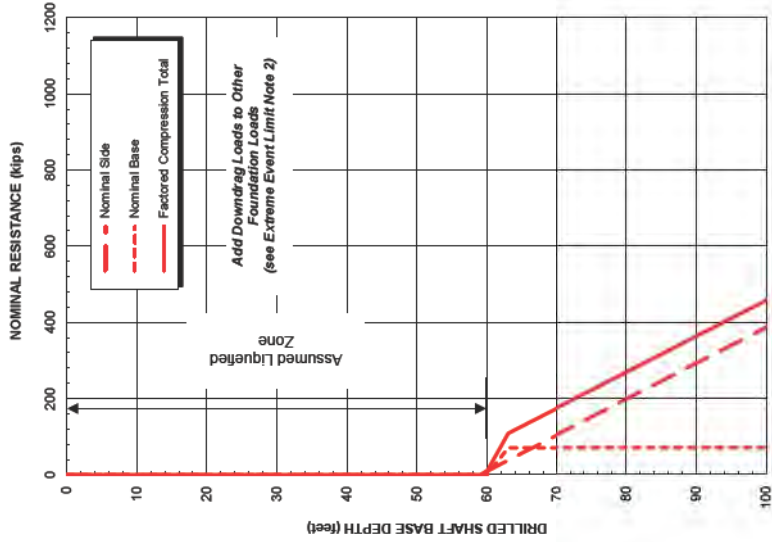

**EXTREME EVENT LIMIT STATE NOTES:**

1. Recommended resistance factors per AASHTO for both side and base resistance are 1.0 for compression and 0.8 for uplift.
2. Unfactored downward force is estimated to be 120 kips. Per AASHTO, a load factor of 1.25 is recommended to determine factored downward force. Downward force is recommended to be applied with post-earthquake loading.

Carkeek Park Pedestrian Bridge  
Replacement Feasibility Study  
Seattle, WA

**ESTIMATED AXIAL RESISTANCE**  
**1.5-FT-DIAM DRILLED SHAFT**  
**SHORE-SIDE (WEST OF RAIL)**  
**LIQUEFACTION TO 60 FEET**

March 2021  
SEA-106937

SHANNON & WILSON, INC.

FIG. 20

**GENERAL NOTES**

1. The analyses were performed based on guidelines included in the AASHTO LRFD Bridge Design Specifications (AASHTO), the WSDOT Geotechnical Design Manual (GDM), and local experience. The analyses are based on a single shaft and do not consider group action of closely spaced shafts (closer than 4 diameters, center to center).
2. Factored total shaft resistance shown on plots is determined by adding its nominal side and base resistances multiplied by the appropriate resistance factors as noted above.
3. Estimated shaft resistance assumes that if casing is used, it will be removed after the shaft installation. If, however, the casing is left in place, grouting should be used to fill all potential voids around the casing and the estimated resistance given above should be re-evaluated.
4. Contribution to axial resistance within the upper 5 feet of the pile is ignored to account for disturbance during construction.

**ASSUMED SUBSURFACE PROFILE**

Based on Nearby Explorations: B-4 (2020)

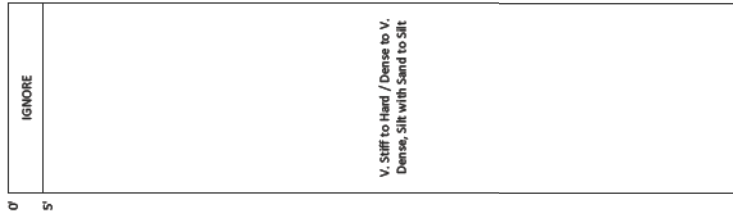

**SERVICE LIMIT STATE**

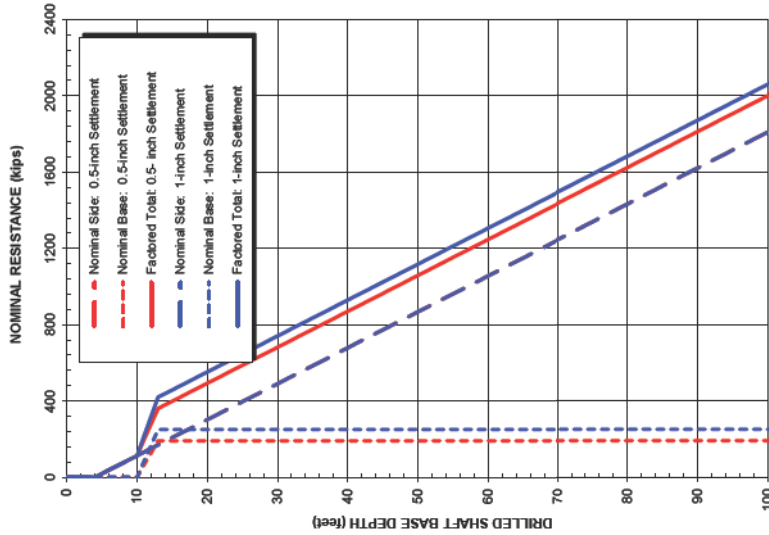

**SERVICE LIMIT STATE NOTES:**

1. Recommended resistance factors per AASHTO are 1.0 for both side and base resistance.
2. Settlement is based on a single shaft. No group action is considered.

**STRENGTH LIMIT STATE**

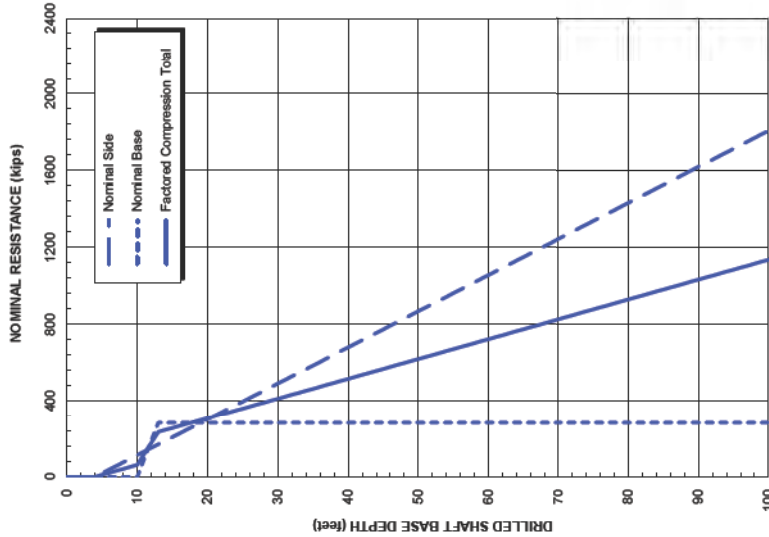

**STRENGTH LIMIT STATE NOTES:**

1. Recommended compression resistance factors per AASHTO are 0.55 and 0.5 for side and base resistance, respectively.
2. Shaft uplift resistance can be estimated by using the nominal side resistance shown above and a recommended resistance factor of 0.35 (per AASHTO).
3. For non-redundant shafts, where a pier/column is supported on a single shaft, the resistance factors are reduced by 20% (per AASHTO).

**EXTREME EVENT LIMIT STATE**

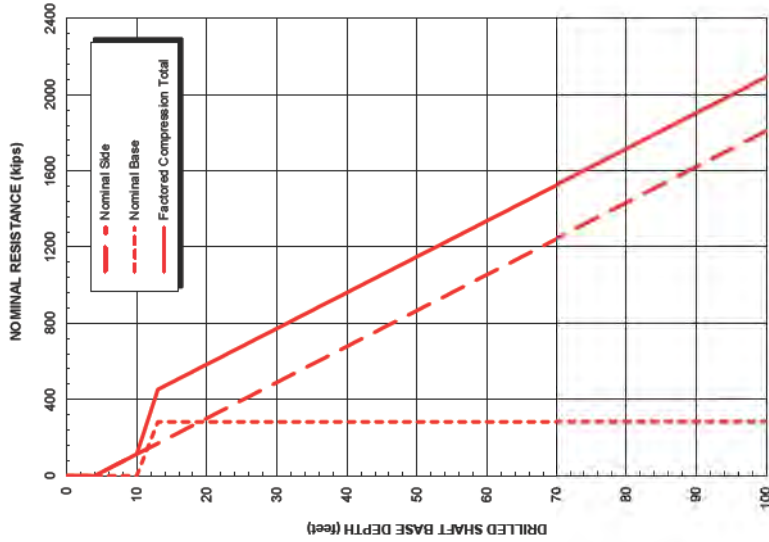

**EXTREME EVENT LIMIT STATE NOTES:**

1. Recommended resistance factors per AASHTO for both side and base resistance are 1.0 for compression and 0.8 for uplift.
2. Unfactored downdrag force is estimated to be 0 kips. Per AASHTO, a load factor of 1.25 is recommended to determine factored downdrag force. Downdrag force is recommended to be applied with positive earthquake loading.

**GENERAL NOTES**

1. The analyses were performed based on guidelines included in the AASHTO LRFD Bridge Design Specifications (AASHTO), the WSDOT Geotechnical Design Manual (GDM), and local experience. The analyses are based on a single shaft and do not consider group action of closely spaced shafts (closer than 4 diameters, center to center).
2. Factored total shaft resistance shown on plots is determined by adding its nominal side and base resistance multiplied by the appropriate resistance factors as noted above.
3. Estimated shaft resistance assumes that if casing is used, it will be removed after the shaft installation. If, however, the casing is left in place, grouting should be used to fill all potential voids around the casing and the estimated resistance given above should be re-evaluated.
4. Contribution to axial resistance within the upper 5 feet of the pile is ignored to account for disturbance during construction.

Carkeek Park Pedestrian Bridge  
Replacement Feasibility Study  
Seattle, WA

ESTIMATED AXIAL RESISTANCE  
3-FT-DIAM DRILLED SHAFT  
PARKING AREA-SIDE (EAST OF RAIL)

March 2021 SEA-105937

SHANNON & WILSON, INC.

FIG. 21

**ASSUMED SUBSURFACE PROFILE**

Based on Nearby Explorations:  
TB-19 (1972)

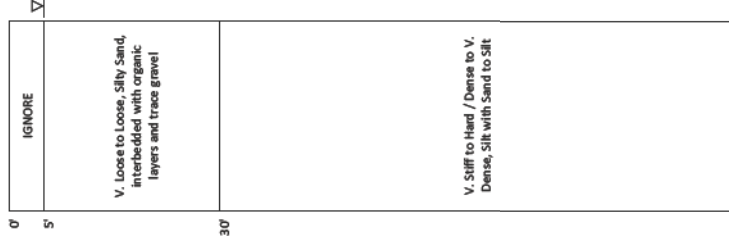

**SERVICE LIMIT STATE**

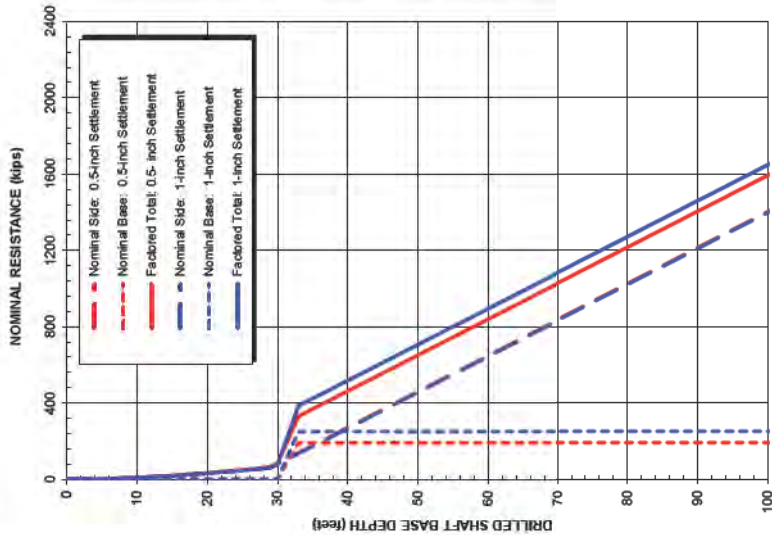

**SERVICE LIMIT STATE NOTES:**

1. Recommended resistance factors per AASHTO are 1.0 for both side and base resistance.
2. Settlement is based on a single shaft. No group action is considered.

**STRENGTH LIMIT STATE**

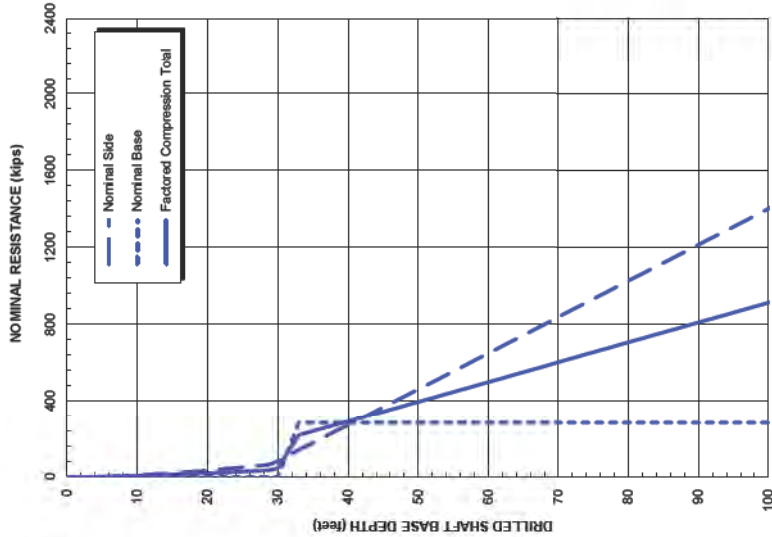

**STRENGTH LIMIT STATE NOTES:**

1. Recommended compression resistance factors per AASHTO are 0.55 and 0.5 for side and base resistance, respectively.
2. Shaft uplift resistance can be estimated by using the nominal side resistance shown above and a recommended resistance factor of 0.35 (per AASHTO).
3. For non-redundant shafts, where a pier/column is supported on a single shaft, the resistance factors are reduced by 20% (per AASHTO).

**EXTREME EVENT LIMIT STATE**

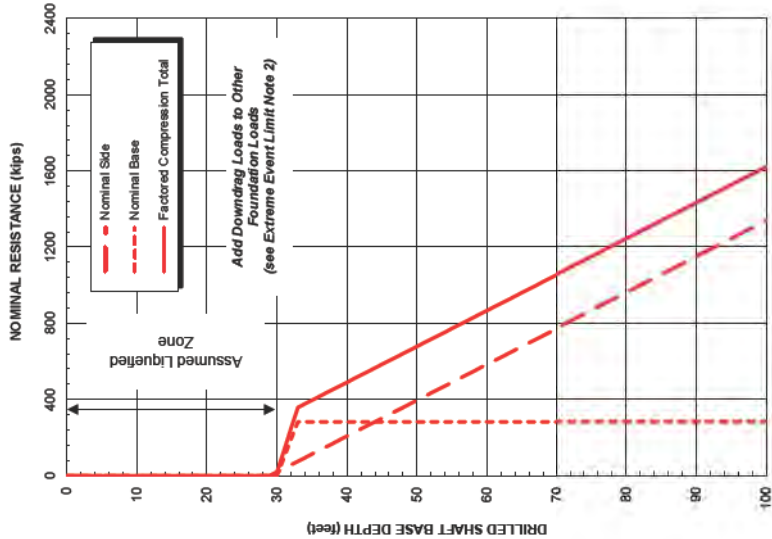

**EXTREME EVENT LIMIT STATE NOTES:**

1. Recommended resistance factors per AASHTO for both side and base resistance are 1.0 for compression and 0.8 for uplift.
2. Unfactored downward force is estimated to be 60 kips. Per AASHTO, a load factor of 1.25 is recommended to determine factored downward force. Downward force is recommended to be applied with post-earthquake loading.

**GENERAL NOTES**

1. The analyses were performed based on guidelines included in the AASHTO LRFD Bridge Design Specifications (AASHTO), the WSDOT Geotechnical Design Manual (GDM), and local experience. The analyses are based on a single shaft and do not consider group action of closely spaced shafts (closer than 4 diameters, center to center).
2. Factored total shaft resistance shown on plots is determined by adding its nominal side and base resistances multiplied by the appropriate resistance factors as noted above.
3. Estimated shaft resistance assumes that if casing is used, it will be removed after the shaft installation. If, however, the casing is left in place, grouting should be used to fill all potential voids around the casing and the estimated resistance given above should be re-evaluated.
4. Contribution to axial resistance within the upper 5 feet of the pile is ignored to account for disturbance during construction.

Carlisle Park Pedestrian Bridge  
Replacement Feasibility Study  
Seattle, WA

ESTIMATED AXIAL RESISTANCE  
3-FT-DIAM DRILLED SHAFT  
SHORE-SIDE (WEST OF RAIL)  
LIQUEFACTION TO 30 FEET

March 2021 SEA-105937

SHANNON & WILSON, INC. FIG. 22



**ASSUMED SUBSURFACE PROFILE**

Based on Nearby Explorations:  
TB-19 (1972)

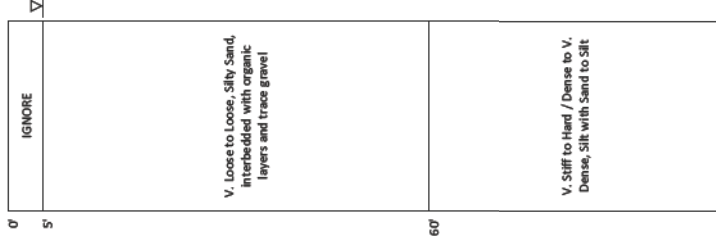

**SERVICE LIMIT STATE**

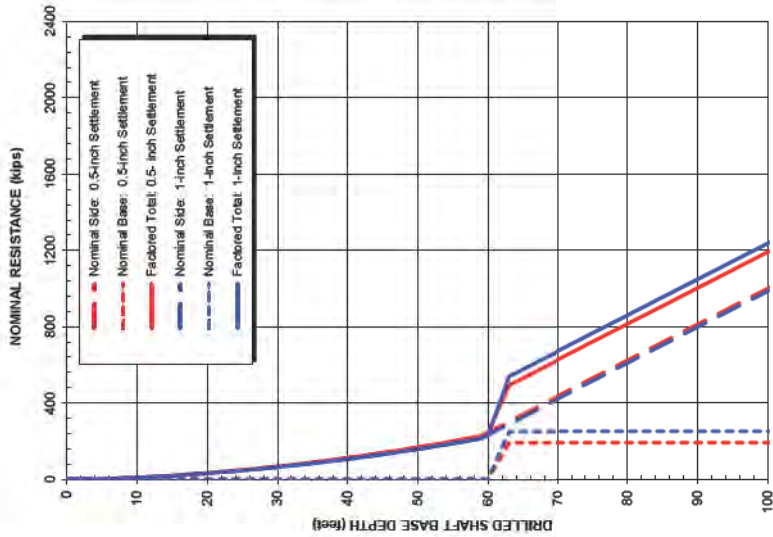

**SERVICE LIMIT STATE NOTES:**

1. Recommended resistance factors per AASHTO are 1.0 for both side and base resistance.
2. Settlement is based on a single shaft. No group action is considered.

**STRENGTH LIMIT STATE**

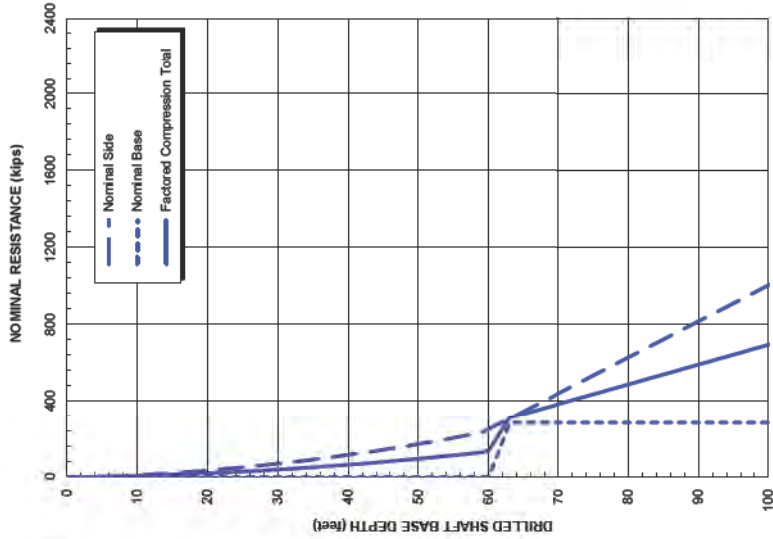

**STRENGTH LIMIT STATE NOTES:**

1. Recommended compression resistance factors per AASHTO are 0.55 and 0.5 for side and base resistance, respectively.
2. Shaft uplift resistance can be estimated by using the nominal side resistance shown above and a recommended resistance factor of 0.35 (per AASHTO).
3. For non-redundant shafts, where a pier/column is supported on a single shaft, the resistance factors are reduced by 20% (per AASHTO).

**EXTREME EVENT LIMIT STATE**

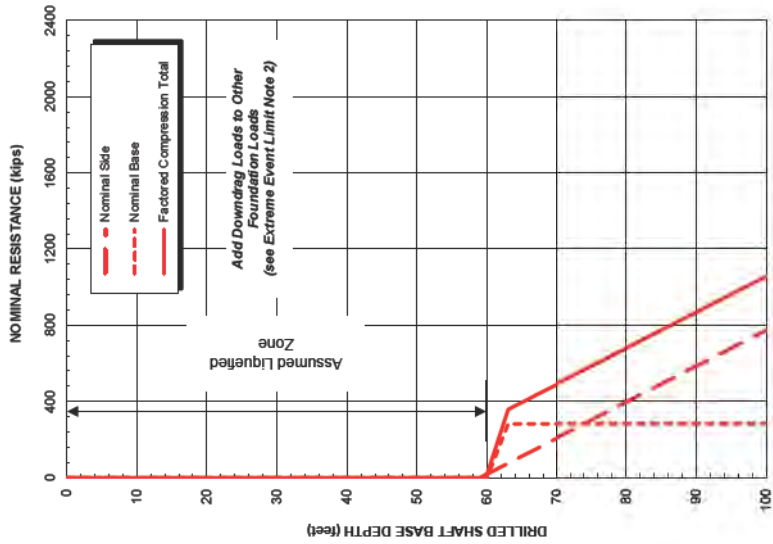

**EXTREME EVENT LIMIT STATE NOTES:**

1. Recommended resistance factors per AASHTO for both side and base resistance are 1.0 for compression and 0.8 for uplift.
2. Unfactored downward force is estimated to be 230 kips. Per AASHTO, a load factor of 1.25 is recommended to determine factored downward force. Downward force is recommended to be applied with post-earthquake loading.

**GENERAL NOTES**

1. The analyses were performed based on guidelines included in the AASHTO LRFD Bridge Design Specifications (AASHTO), the WSDOT Geotechnical Design Manual (GDM), and local experience. The analyses are based on a single shaft and do not consider group action of closely spaced shafts (closer than 4 diameters, center to center).
2. Factored total shaft resistance shown on plots is determined by adding its nominal side and base resistance multiplied by the appropriate resistance factors as noted above.
3. Estimated shaft resistance assumes that if casing is used, it will be removed after the shaft installation. If, however, the casing is left in place, grouting should be used to fill all potential voids around the casing and the estimated resistance given above should be re-evaluated.
4. Contribution to axial resistance within the upper 5 feet of the pile is ignored to account for disturbance during construction.

Carleek Park Pedestrian Bridge  
Replacement Feasibility Study  
Seattle, WA

ESTIMATED AXIAL RESISTANCE  
3-FT-DIAM DRILLED SHAFT  
SHORE-SIDE (WEST OF RAIL)  
LIQUEFACTION TO 60 FEET

March 2021 SEA-105937

SHANNON & WILSON, INC.

FIG. 23

Appendix A

# Existing Subsurface Explorations

## CONTENTS

- Log of Boring B-4
- Log of Boring TB-19

Total Depth: 41.4 ft. Northing: \_\_\_\_\_ Drilling Method: Hollow Stem Auger Hole Diam.: \_\_\_\_\_  
 Top Elevation: ~ Easting: \_\_\_\_\_ Drilling Company: Holt Services Rod Diam.: 6-inch  
 Vert. Datum: \_\_\_\_\_ Station: \_\_\_\_\_ Drill Rig Equipment: LDS 75 HT CC Drill Hammer Type: Hydraulic  
 Horiz. Datum: \_\_\_\_\_ Offset: \_\_\_\_\_ Other Comments: \_\_\_\_\_

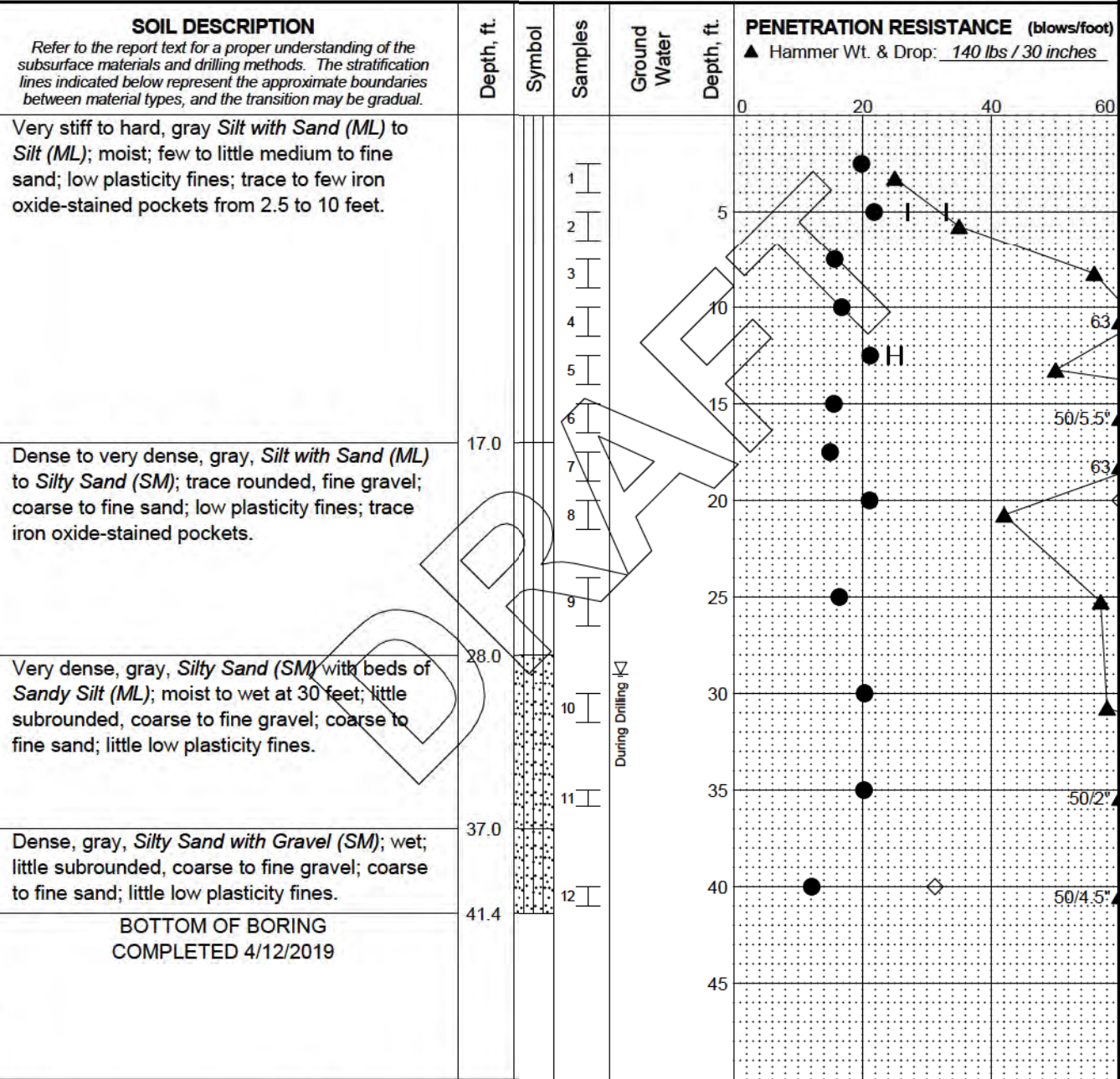

Log: KWS Rev: AJD Typ: LKV  
MASTER LOG E 102539-001.GPJ SHAN WIL GDT 6/13/19

**LEGEND**

\* Sample Not Recovered      ▽ Ground Water Level ATD  
 I 2.0" O.D. Split Spoon Sample      ◇ % Fines (<0.075mm)  
 ● % Water Content  
 Plastic Limit —●— Liquid Limit  
 Natural Water Content

**NOTES**

- Refer to KEY for explanation of symbols, codes, abbreviations and definitions.
- Groundwater level, if indicated above, is for the date specified and may vary.
- USCS designation is based on visual-manual classification and selected lab testing.

BNSF Railway  
 WSDOT Landslide Mitigation  
 LS 50, MP 10.5, Seattle, WA

**LOG OF BORING B-4**

June 2019 102539-001

**SHANNON & WILSON, INC.**  
 Geotechnical and Environmental Consultants **FIG. A-5**



SEATTLE ENGINEERING DEPARTMENT  
 MATERIALS LABORATORY  
**LOG OF TEST BORING**

DATE 3-14-72 HOLE NO. 19  
 PROJECT N. GREENWOOD W. GRD. ELEV. \_\_\_\_\_  
 LOCATION CULVER AT R.R. 302 S. OF E. OF CULBERT & 62 W. OF FINE.

STRATA	DEPTH	SAMPLE NO.	BLOW COUNT	STD. PEN.	DESCRIPTION OF MATERIAL				WATER LEVEL
					COMPOSITION	CONSISTENCY	MOISTURE	COLOR	
					BON SILTY SAND				
			18"		FINE SAND w/ THIN SILT LAYER				
		A	2	2					
			12"						
		B x	1	1	FINE SAND	LOOSE	SAT	BRN	Creek Level
			12"						
		C x	1	1	16" FINE SAND	LOOSE	SAT	GRAY	
			12"		2" ORANGE (PEAT)		MOIST	BRN	
		D x	1	1	12" ORGANIC (PEAT)	SOFT	MOIST	BRN	
			18"						
		E	2	2	ORGANIC (PEAT)	SOFT	MOIST	BRN	
					1" SILTY SAND w/ ORGANIC			GRAY	
		F	1	6	GRAVELLY SAND	FIRM	SAT	GRAY	
					6" GRAVELLY SAND w/ ORGANIC				
		G	10	5	FINE SAND	LOOSE	SAT	GRAY	
			12"						
		H	2	1	SILTY FINE SAND w/ ORGANIC	LOOSE	MOIST	GRAY	
			12"						
		I	1	2	SILT-V. FINE SAND	LOOSE	WET	GRAY	
		J	1	1	SILT-V. FINE SAND w/ THIN ORGANIC	LOOSE	WET	GRAY	

INSPECTOR



# Important Information

About Your Geotechnical Report

**IMPORTANT INFORMATION**

## CONSULTING SERVICES ARE PERFORMED FOR SPECIFIC PURPOSES AND FOR SPECIFIC CLIENTS.

Consultants prepare reports to meet the specific needs of specific individuals. A report prepared for a civil engineer may not be adequate for a construction contractor or even another civil engineer. Unless indicated otherwise, your consultant prepared your report expressly for you and expressly for the purposes you indicated. No one other than you should apply this report for its intended purpose without first conferring with the consultant. No party should apply this report for any purpose other than that originally contemplated without first conferring with the consultant.

## THE CONSULTANT'S REPORT IS BASED ON PROJECT-SPECIFIC FACTORS.

A geotechnical/environmental report is based on a subsurface exploration plan designed to consider a unique set of project-specific factors. Depending on the project, these may include the general nature of the structure and property involved; its size and configuration; its historical use and practice; the location of the structure on the site and its orientation; other improvements such as access roads, parking lots, and underground utilities; and the additional risk created by scope-of-service limitations imposed by the client. To help avoid costly problems, ask the consultant to evaluate how any factors that change subsequent to the date of the report may affect the recommendations. Unless your consultant indicates otherwise, your report should not be used (1) when the nature of the proposed project is changed (for example, if an office building will be erected instead of a parking garage, or if a refrigerated warehouse will be built instead of an unrefrigerated one, or chemicals are discovered on or near the site); (2) when the size, elevation, or configuration of the proposed project is altered; (3) when the location or orientation of the proposed project is modified; (4) when there is a change of ownership; or (5) for application to an adjacent site. Consultants cannot accept responsibility for problems that may occur if they are not consulted after factors that were considered in the development of the report have changed.

## SUBSURFACE CONDITIONS CAN CHANGE.

Subsurface conditions may be affected as a result of natural processes or human activity. Because a geotechnical/environmental report is based on conditions that existed at the time of subsurface exploration, construction decisions should not be based on a report whose adequacy may have been affected by time. Ask the consultant to advise if additional tests are desirable before construction starts; for example, groundwater conditions commonly vary seasonally.

Construction operations at or adjacent to the site and natural events such as floods, earthquakes, or groundwater fluctuations may also affect subsurface conditions and, thus, the continuing adequacy of a geotechnical/environmental report. The consultant should be kept apprised of any such events and should be consulted to determine if additional tests are necessary.

## MOST RECOMMENDATIONS ARE PROFESSIONAL JUDGMENTS.

Site exploration and testing identifies actual surface and subsurface conditions only at those points where samples are taken. The data were extrapolated by your consultant, who then applied judgment to render an opinion about overall subsurface conditions. The actual interface between materials may be far more gradual or abrupt than your report indicates. Actual conditions in areas not sampled may differ from those predicted in your report. While nothing can be done to prevent such situations, you and your consultant can work together to help reduce their impacts. Retaining

your consultant to observe subsurface construction operations can be particularly beneficial in this respect.

#### A REPORT'S CONCLUSIONS ARE PRELIMINARY.

The conclusions contained in your consultant's report are preliminary, because they must be based on the assumption that conditions revealed through selective exploratory sampling are indicative of actual conditions throughout a site. Actual subsurface conditions can be discerned only during earthwork; therefore, you should retain your consultant to observe actual conditions and to provide conclusions. Only the consultant who prepared the report is fully familiar with the background information needed to determine whether or not the report's recommendations based on those conclusions are valid and whether or not the contractor is abiding by applicable recommendations. The consultant who developed your report cannot assume responsibility or liability for the adequacy of the report's recommendations if another party is retained to observe construction.

#### THE CONSULTANT'S REPORT IS SUBJECT TO MISINTERPRETATION.

Costly problems can occur when other design professionals develop their plans based on misinterpretation of a geotechnical/environmental report. To help avoid these problems, the consultant should be retained to work with other project design professionals to explain relevant geotechnical, geological, hydrogeological, and environmental findings, and to review the adequacy of their plans and specifications relative to these issues.

#### BORING LOGS AND/OR MONITORING WELL DATA SHOULD NOT BE SEPARATED FROM THE REPORT.

Final boring logs developed by the consultant are based upon interpretation of field logs (assembled by site personnel), field test results, and laboratory and/or office evaluation of field samples and data. Only final boring logs and data are customarily included in geotechnical/environmental reports. These final logs should not, under any circumstances, be redrawn for inclusion in architectural or other design drawings, because drafters may commit errors or omissions in the transfer process.

To reduce the likelihood of boring log or monitoring well misinterpretation, contractors should be given ready access to the complete geotechnical engineering/environmental report prepared or authorized for their use. If access is provided only to the report prepared for you, you should advise contractors of the report's limitations, assuming that a contractor was not one of the specific persons for whom the report was prepared, and that developing construction cost estimates was not one of the specific purposes for which it was prepared. While a contractor may gain important knowledge from a report prepared for another party, the contractor should discuss the report with your consultant and perform the additional or alternative work believed necessary to obtain the data specifically appropriate for construction cost estimating purposes. Some clients hold the mistaken impression that simply disclaiming responsibility for the accuracy of subsurface information always insulates them from attendant liability. Providing the best available information to contractors helps prevent costly construction problems and the adversarial attitudes that aggravate them to a disproportionate scale.

#### READ RESPONSIBILITY CLAUSES CLOSELY.

Because geotechnical/environmental engineering is based extensively on judgment and opinion, it is far less exact than other design disciplines. This situation has resulted in wholly unwarranted claims



being lodged against consultants. To help prevent this problem, consultants have developed a number of clauses for use in their contracts, reports, and other documents. These responsibility clauses are not exculpatory clauses designed to transfer the consultant's liabilities to other parties; rather, they are definitive clauses that identify where the consultant's responsibilities begin and end. Their use helps all parties involved recognize their individual responsibilities and take appropriate action. Some of these definitive clauses are likely to appear in your report, and you are encouraged to read them closely. Your consultant will be pleased to give full and frank answers to your questions.

**The preceding paragraphs are based on information provided by the ASFE/Association of Engineering Firms Practicing in the Geosciences, Silver Spring, Maryland**

IMPORTANT INFORMATION



**Appendix C**  
**Concept Design Plan**

# CARKEEK PARK

# PEDESTRIAN BRIDGE REPLACEMENT

Parks Specification # 0000 PW # 0000-000 Project # PRK000000-00

Funding Source: Seattle Parks District/Other Funding Source

**Owner:**

City of Seattle Department of Finance & Administrative Services,  
Purchasing & Contracting

**Administering Department:**

City of Seattle Department of Parks and Recreation, Planning & Development Division  
300 Elliot Avenue West, Suite 100, Seattle, WA 98119  
Project Manager: Name 206-000-0000

**Project Design Team:**

SPR PROJECT MANAGER:

**COLIN CAMPBELL**

206-000-0000

CIVIL & STRUCTURAL ENGINEER

**RHC ENGINEERING**

ARCHITECT

**LMN ARCHITECTS**

GEOTECHNICAL ENGINEER

**SHANNON & WILSON, INC.**

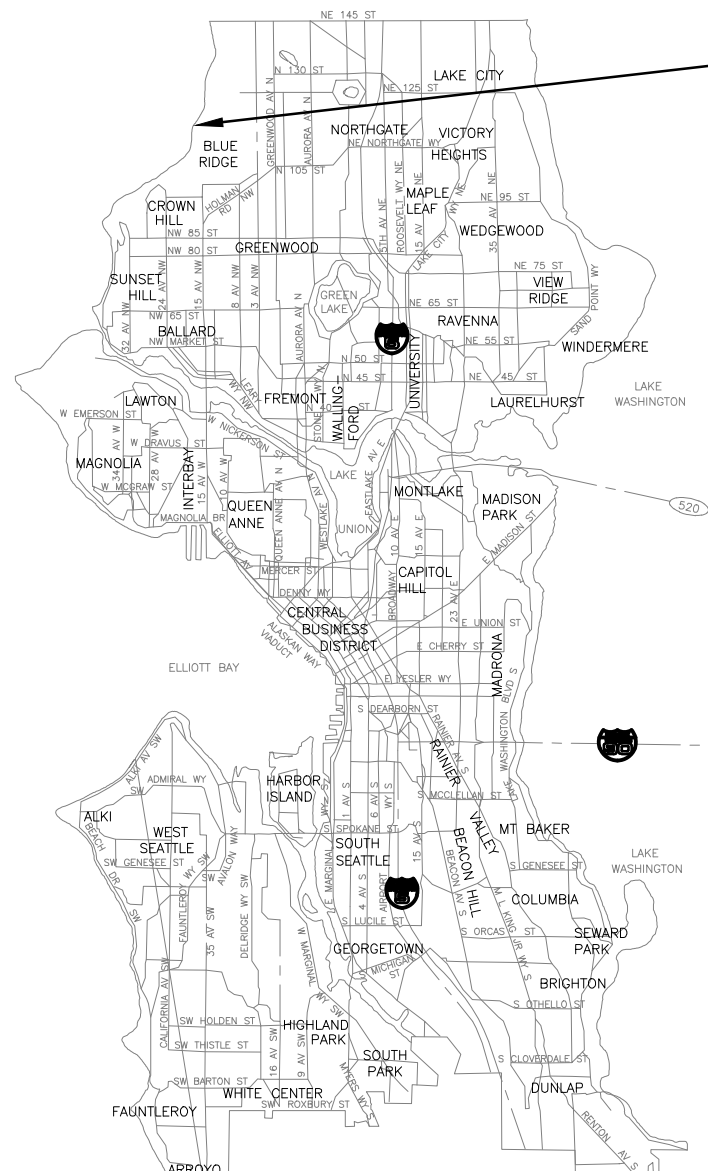

Project Site Location

Project Address  
855 NW 114TH Street  
Seattle, WA 98177

LEGAL DESCRIPTION

Lot, Block, Section, etc.

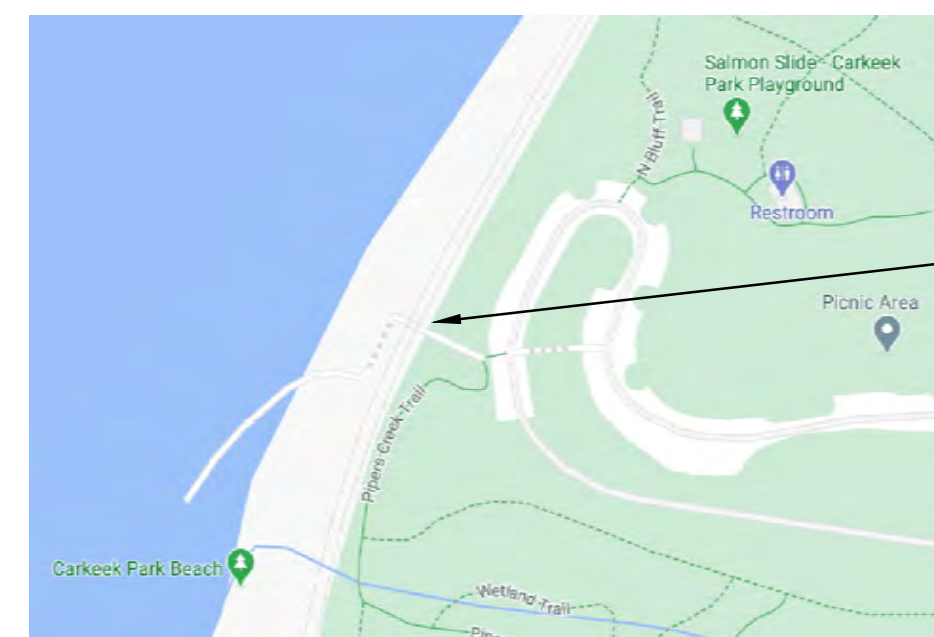

BRIDGE LOCATION

VICINITY MAP

CITY OF SEATTLE - NOT TO SCALE

LOCATION MAP

## STANDARD ABBREVIATIONS

Aban	Abandon(ed)	Gal	Gallon	Qty	Quantity
Adj	Adjust	GPM	Gallons Per Minute	R	Radius
ADA	Americans with Disabilities Act	Galv	Galvanized/Galvanized	RR	Railroad
AIC	Aerial Interconnect	GIP	Galvanized Iron Pipe	Rtlyw	Railway
Al	Aluminum	GSP	Galvanized Steel Pipe	Reconn	Reconnect
AP	Angle Point	GM	Gas Meter	Red	Reducer
Approx	Approximate	G Reg	Gas Regulator	Ref	Refer/Reference
Asph	Asphalt	G V	Gas Valve	Reinf	Reinforcing/Reinforcement
ASW	Asphalt Bike Way	Gf	Grade	RCP	Reinforced Concrete Pipe
ATB	Asphalt Treated Base	Gnd	Ground	Reloc	Relocate
ACV	Automatic Control Valve	GP	Guy Pole	Rem	Remove
AVB	Automatic Vacuum Breaker	HH	Handhole	R&R	Remove and Replace
Ave	Avenue	HPCG	High Pressure Gas	Repl	Replace
Av	Average	HPS	High Pressure Sodium	Req'd	Required
BV	Ball Valve	Horiz	Horizontal	Ret	Retire(d)
BOC	Beginning of Curb	HB	Hose Bib	Rt	Right
BO	Blow Off	HC	Hose Connection	R/W	Right of Way
BF	Bottom Face	Hse	House	RSS	Rigid Galvanized Steel
Br	Brick	Hyd	Hydrant	RS	Rigid Steel
Blkhd	Bulkhead	In	Inch/Inches	Rdwy	Roadway
BFV	Butterfly Valve	Inl	Inlet	RD	Roof Drain
Cb	Cable	ID	Inside Diameter	SB	Sand Box
Cal	Caliper	IE	Invert Elevation	SCL	Seattle City Light
OIP	Cast Iron Pipe	Inv	Invert (Line)	SED	Seattle Engineering Dept.
CB	Catch Basin	IP	Iron Pipe	SWD	Seattle Water Department
CL	Center Line	Irrg	Irrigation	SG	Subgrade
C-C	Center to Center	IRC	Irrigation Controller	SD	Service Drain
CLF	Chain Link Fence	Irrg	Irrigation	Sht	Sheet
Ch	Chamber	IH	Irrigation Head	SS	Side Sewer - Combined
Cl	Class	Jt	Joint	SSS	Side Sewer - Sanitary
CO	Clean Out	JB	Junction Box	SI	Sleeve
Clr	Clearance	KV	Kilovolt	Spce	Spaces
Conc	Concrete	LT	Large Inlet Top	Spec	Specification(s)
CSW	Concrete Bike Way	Lt	Left	SH	Sprinkler Head
CC	Concrete Culvert	LP	Light Pole	Sq	Square
CW	Concrete Walk	LF	Lineal Feet	Std	Standard
Cond	Condition	Loc	Location/Locate	Stl	Steel
Cd	Conduit	MH	Manhole	Stl P	Steel Pipe
Conn	Connect	MCV	Manual Control Valve	St	Street
CMP	Corrugated Metal Pipe	MDV	Manual Drain Valve	SDS	Street Designation Sign
Cont	Continuous	Max	Maximum	SLHH	Street Light Handhole
Cr	Cross	MJ	Mechanical Joint	SNS	Street Name Sign
Cu Ft	Cubic Feet	MVL	Mercury Vapor Light	Struct	Structural/Structure
Cu Yd	Cubic Yard	Min	Minimum	SL	Survey Line
Culv	Culvert	Misc	Miscellaneous	T	Tee
C&G	Curb and Gutter	ML	Monument Line	Tel	Telephone
CR	Curb Radius	NIC	Not in Contract	TCb	Telephone Cable
Dept	Department	NTS	Not To Scale	TCd	Telephone Conduit
Dia	Diameter	No.	Number	TC	Top of Curb
DB	Direct Burial Cable	OC	On Center	THH	Telephone Handhole
DGV	District Gate Valve	OD	Outside Diameter	TVCb	Television Cable
DCV	Double Check Valve	Pav	Pavement	TVHH	Television Handhole
Dwy	Driveway	PPB	Pedestrian Push Button	Temp	Temporary
DIP	Ductile Iron Pipe	PDP	Perforated Drain Pipe	TH	Testhole
Ea	Each	PS	Pipe Sewer Combined	TF	Top Face
Esmt	Easement	PSS	Pipe Sewer Sanitary	Tr	Traffic
Ecc	Eccentric	PSD	Pipe Storm Drain	TrCb	Traffic Cable
Elec	Electric/Electrical	PSDD	Pipe Storm Drain Detention	TrCd	Traffic Conduit
ECb	Electric Cable	PE	Plain End	TCHH	Traffic Handhole
ECd	Electric Conduit	PL	Plate	TrSB	Traffic Signal Box
ED	Electric Duct	PCC	Point of Compound Curvature	TrSP	Traffic Signal Pole
EMH	Electric Manhole	PC	Point of Curvature	XP	Transmission Pole
EV	Electric Vault	PI	Point of Intersection	Typ	Typical
EI	Elevation	PRC	Point of Reverse Curve	VCh	Valve Chamber
Elev	Elevation	PT	Point of Tangency	V/Var	Variable
Encl	Enclosure	PVC	Polyvinyl Chloride	Vrt	Vertical
EOC	End of Curb	LBS	Pounds	VB	Valve Box
Eq	Equal	PSI	Pounds per Square Inch	V/C	Vertical Curve
Ex	Existing	PP	Power Pole	W	Water
Exp	Expansion	PPL	Power Pole with Light	WM	Water Meter
Ft	Feet	PRV	Pressure Reducing Valve	WCR	Wheel Chair Ramp
FLP	Field Light Pole	PVB	Pressure Vacuum Breaker	w/	With
Fig	Figure	PL	Property Line	WP	Wood Pole
FF	Finished Floor	Prop	Proposed	WSP	Wood Stave Pipe
FG	Finish Grade				
FS	Finished Surface (paving)				
FM	Force Main				

## GENERAL NOTES:

- A PROFESSIONAL SURVEY IS REQUIRED FOR FINAL PLAN SET.
- BRIDGE DESIGN CRITERIA:
  - AASHTO LRFD GUIDE SPECIFICATIONS FOR THE DESIGN OF PEDESTRIAN BRIDGES, 2009
  - AASHTO LRFD BRIDGE DESIGN SPECIFICATIONS, 2017
- BRIDGE DESIGN LOADS (PRELIMINARY)
  - PEDESTRIAN: 90 PSF
  - AASHTO H-10 WITHOUT IMPACT
  - WIND LOAD: 115 MPH
  - SEISMIC LOAD: SDS=1.05, SD1=0.67, SITE CLASS D
- MATERIALS
  - STRUCTURAL STEEL: ASTM A709 GRADE 50W
  - REINFORCEMENT: ASTM A706 GRADE 60
  - STEEL CABLE: ASTM A586 OR ASTMA603
  - STEEL MICROPILE: ASTM A GRADE 36
  - CONCRETE DECK: F'C=5000 KSI
  - CONCRETE FOUNDATION: CLASS 4000
  - MICRO-PILES: ASTM A847

## SHEET INDEX

- |    |                         |
|----|-------------------------|
| 01 | COVER SHEET             |
| 02 | CIVIL SITE PLAN         |
| 03 | BRIDGE PLAN AND PROFILE |
| 04 | TYPICAL SECTIONS        |

**>>>>CAUTION - CALL 811<<<<**  
**UTILITY NOTIFICATION CENTER**  
**BEFORE YOU DIG!**  
**WWW.CALL811.COM**

Also, verify all underground utilities not located by the 811 service by using a commercial location service and call SPR Inspection Request Line (206) 684-7034.

APPROVED FOR ADVERTISING:	7		
Liz Alzeer	6		
Purchasing & Contracting	5		
Seattle, Washington	4		
Date	3		
20	2		
Signature:	1		
Director, Purchasing & Contracting	NO.	REVISION - AS BUILT	DATE

REVIEWED: \_\_\_\_\_ DATE \_\_\_\_\_  
PARK ENGINEER \_\_\_\_\_

All work done in accordance with the City of Seattle Standard Plans and Specifications in effect on the date shown above, and supplemented by Special Provisions.

**RHC ENGINEERING**  
WWW.RHCENGINEERING.COM  
720 3RD AVE SUITE 1400  
SEATTLE WA 98104  
PH: 206.623.5984

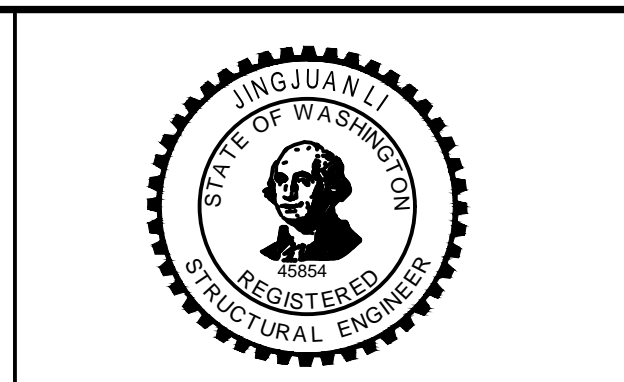

**CARKEEK PARK**  
**PEDESTRIAN BRIDGE REPLACEMENT**  
**COVER SHEET**

DESIGNED	JL	DATE	03/05/2021
DRAWN	TL	SHEET	1 OF 4
CHECKED	GMC	Sht. No.	
ORDINANCE NO.	X		
SPECIFICATION NO.	X		
SCALE	X		



SEC.26 T.26N R.3E W.M.

10 5 0 10 20  
SCALE IN FEET

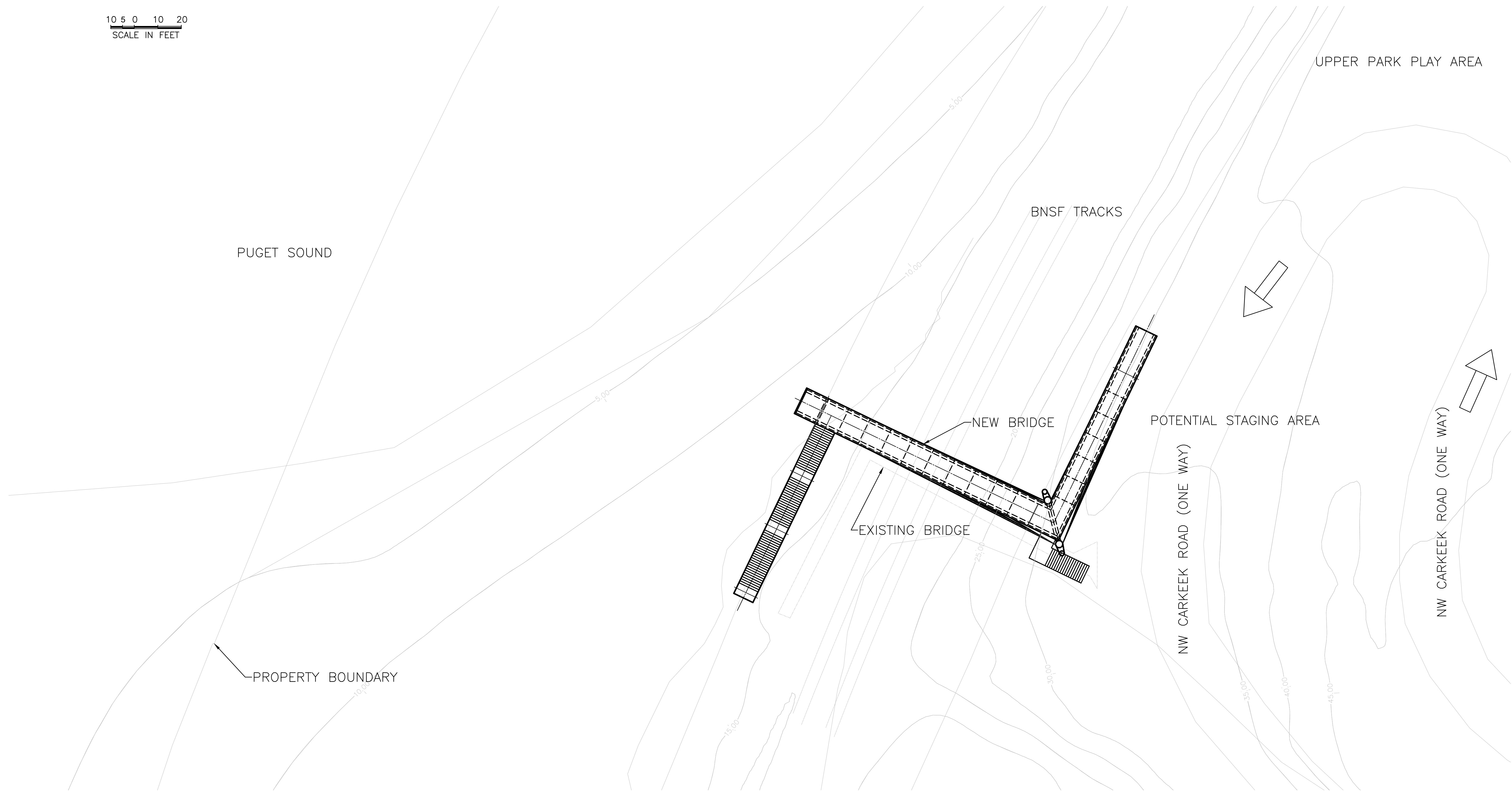

- PROPOSED CONSTRUCTION SEQUENCE:
1. CONSTRUCT BEACH SIDE SPREAD FOOTINGS FOR STAIR AND MICROPILE FOUNDATION FOR BRIDGE.
  2. CONSTRUCT PARKING SIDE FOUNDATIONS AND TOWERS.
  3. REMOVE EXISTING BRIDGE.
  4. PLACE STAIR BEAMS, STAIRS, AND GIRDERS
  5. PLACE CABLES
  6. PLACE PRECAST DECK PANELS AND ADJUST CABLE TENSION
  7. PLACE BARRIER AND DECK FINISH.

PRELIMINARY NOT FOR CONSTRUCTION

>>>>CAUTION - CALL 811<<<<  
UTILITY NOTIFICATION CENTER  
BEFORE YOU DIG!  
WWW.CALL811.COM  
Also, verify all underground utilities not located by the 811 service by using a commercial location service and call SPR Inspection Request Line (206) 684-7034.

7		
6		
5		
4		
3		
2		
1		
NO.	REVISION -- AS BUILT	DATE

REVIEWED: \_\_\_\_\_ DATE \_\_\_\_\_  
PARK ENGINEER

All work done in accordance with the City of Seattle Standard Plans and Specifications in effect on the date shown above, and supplemented by Special Provisions.

**RHC ENGINEERING**  
WWW.RHCENGINEERING.COM  
720 3RD AVE SUITE 1400  
SEATTLE WA 98104  
PH: 206.623.5984

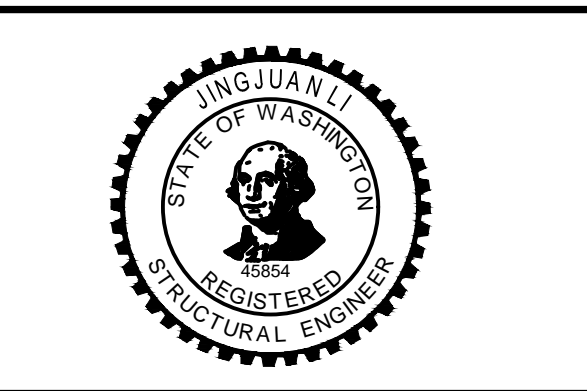

**Seattle Parks & Recreation**

**CARKEEK PARK**  
**PEDESTRIAN BRIDGE REPLACEMENT**  
**SITE PLAN**

DESIGNED	JL
DRAWN	YW
CHECKED	GMC
ORDINANCE NO.	X
SPECIFICATION NO.	X
SCALE	X

DATE 03/05/2021  
SHEET 2 OF 4  
**Sht. No.**



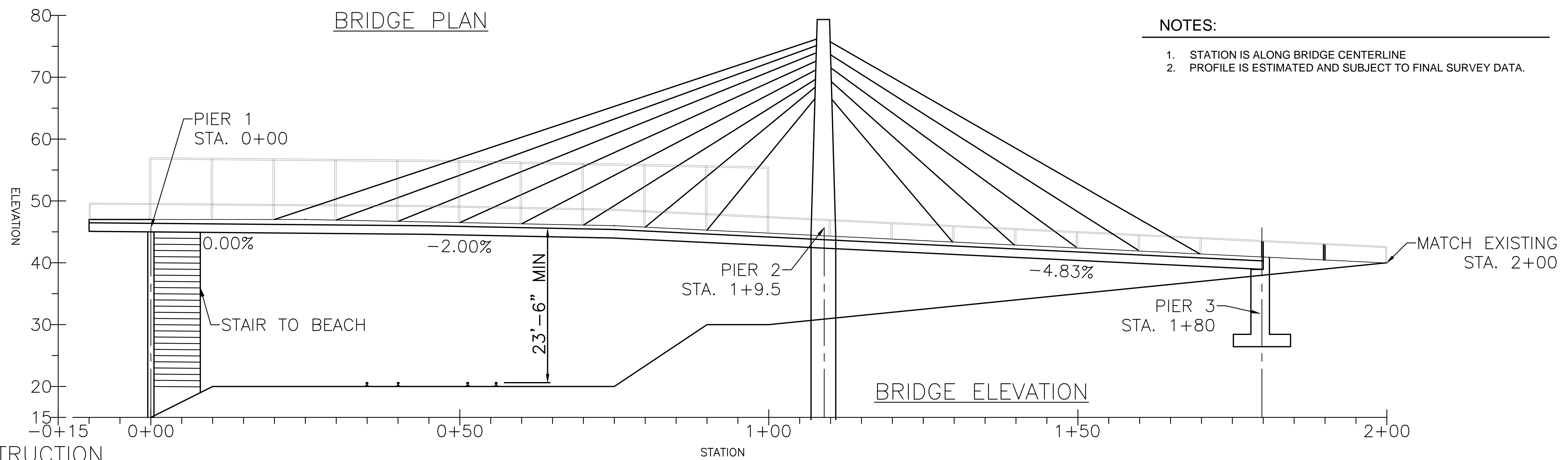
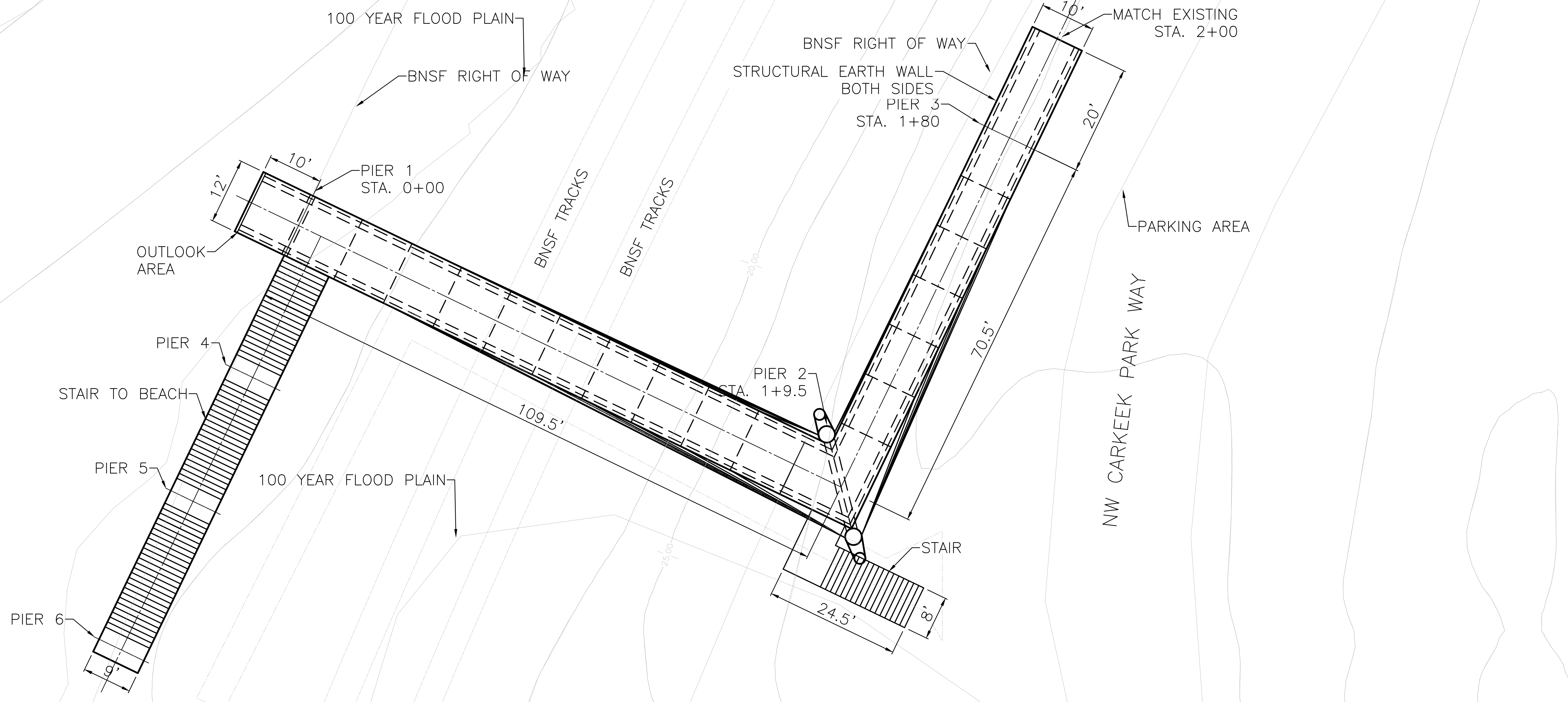

- NOTES:**
1. STATION IS ALONG BRIDGE CENTERLINE
  2. PROFILE IS ESTIMATED AND SUBJECT TO FINAL SURVEY DATA.

PRELIMINARY NOT FOR CONSTRUCTION

**>>>>CAUTION - CALL 811<<<<**  
**UTILITY NOTIFICATION CENTER**  
**BEFORE YOU DIG!**  
**WWW.CALL811.COM**  
Also, verify all underground utilities not located by the 811 service by using a commercial location service and call SPR Inspection Request Line (206) 684-7034.

NO.	REVISION	DATE
7		
6		
5		
4		
3		
2		
1		
	REVISION - AS BUILT	

REVIEWED: \_\_\_\_\_ DATE \_\_\_\_\_  
 PARK ENGINEER

All work done in accordance with the City of Seattle Standard Plans and Specifications in effect on the date shown above, and supplemented by Special Provisions.

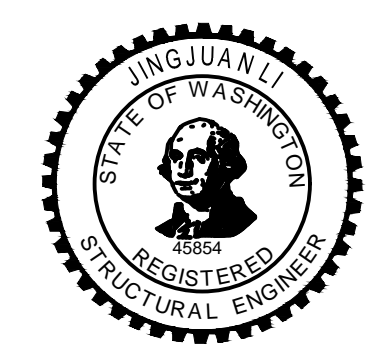

**CARKEEK PARK**  
**PEDESTRIAN BRIDGE**  
**REPLACEMENT**  
**PLAN & ELEVATION**

DESIGNED	JL
DRAWN	TL
CHECKED	GMC
ORDINANCE NO.	X
SPECIFICATION NO.	X
SCALE	X

DATE 03/05/2021  
 SHEET 3 OF 4  
**Sht. No.**



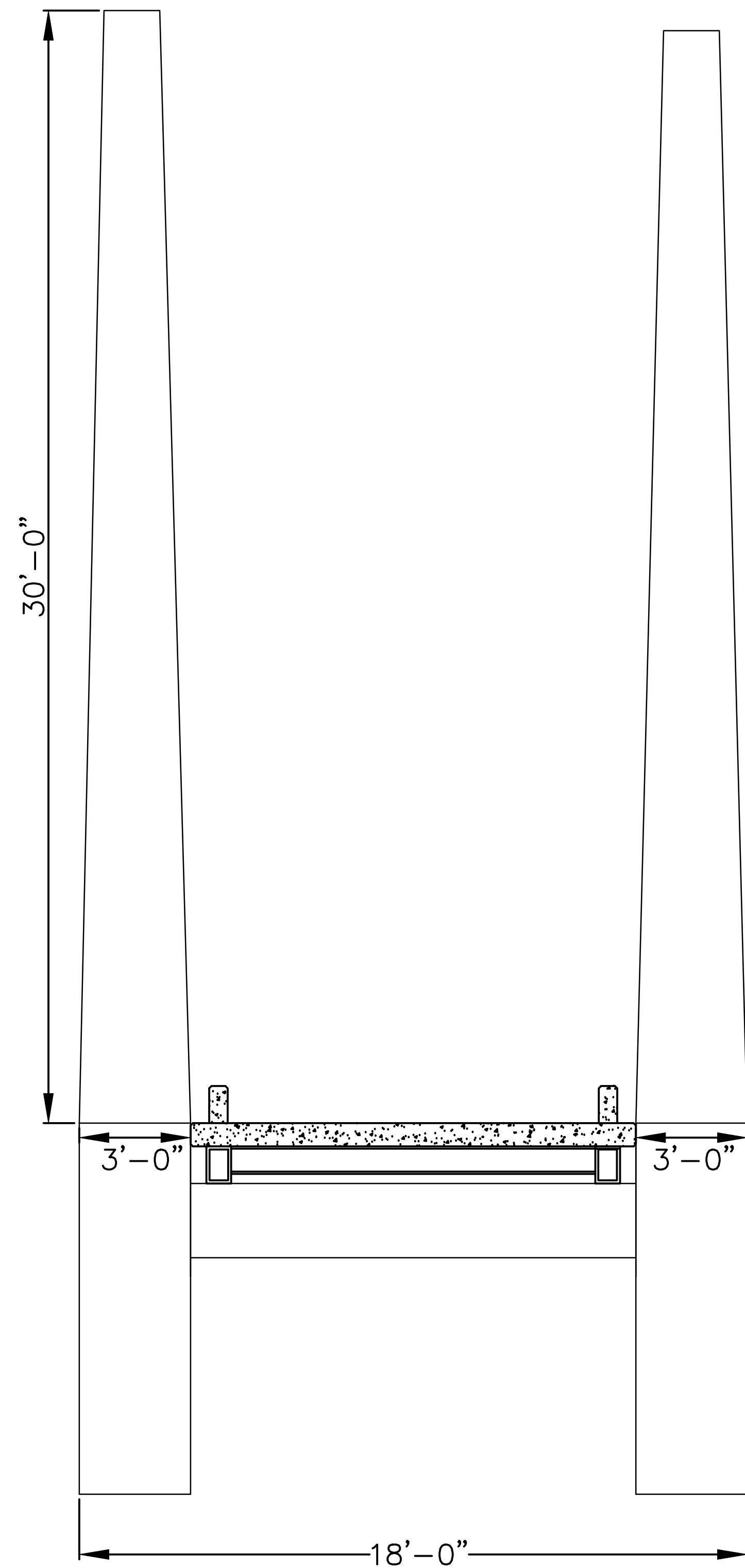

TOWER SECTION

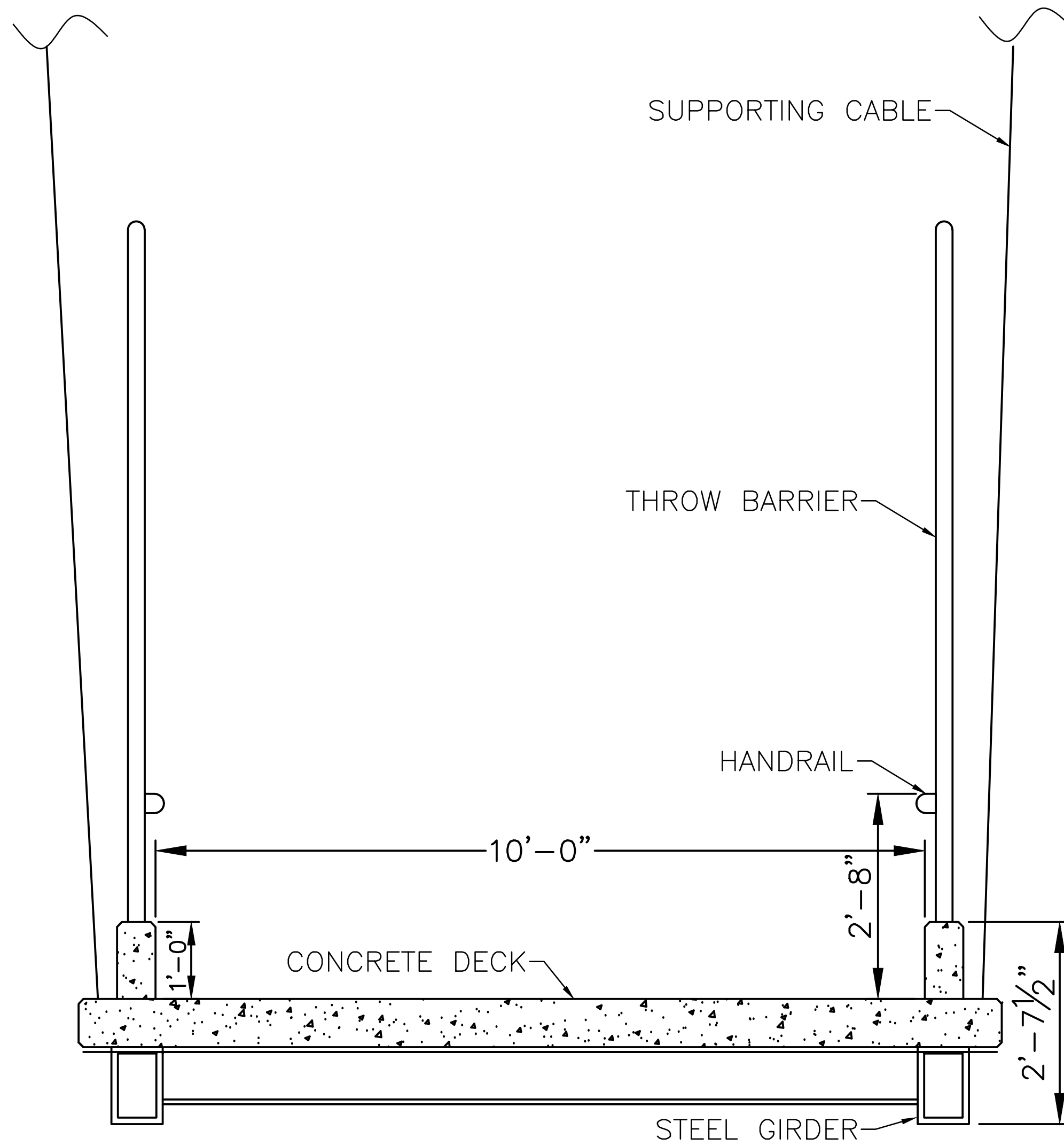

MAIN SPAN SECTION

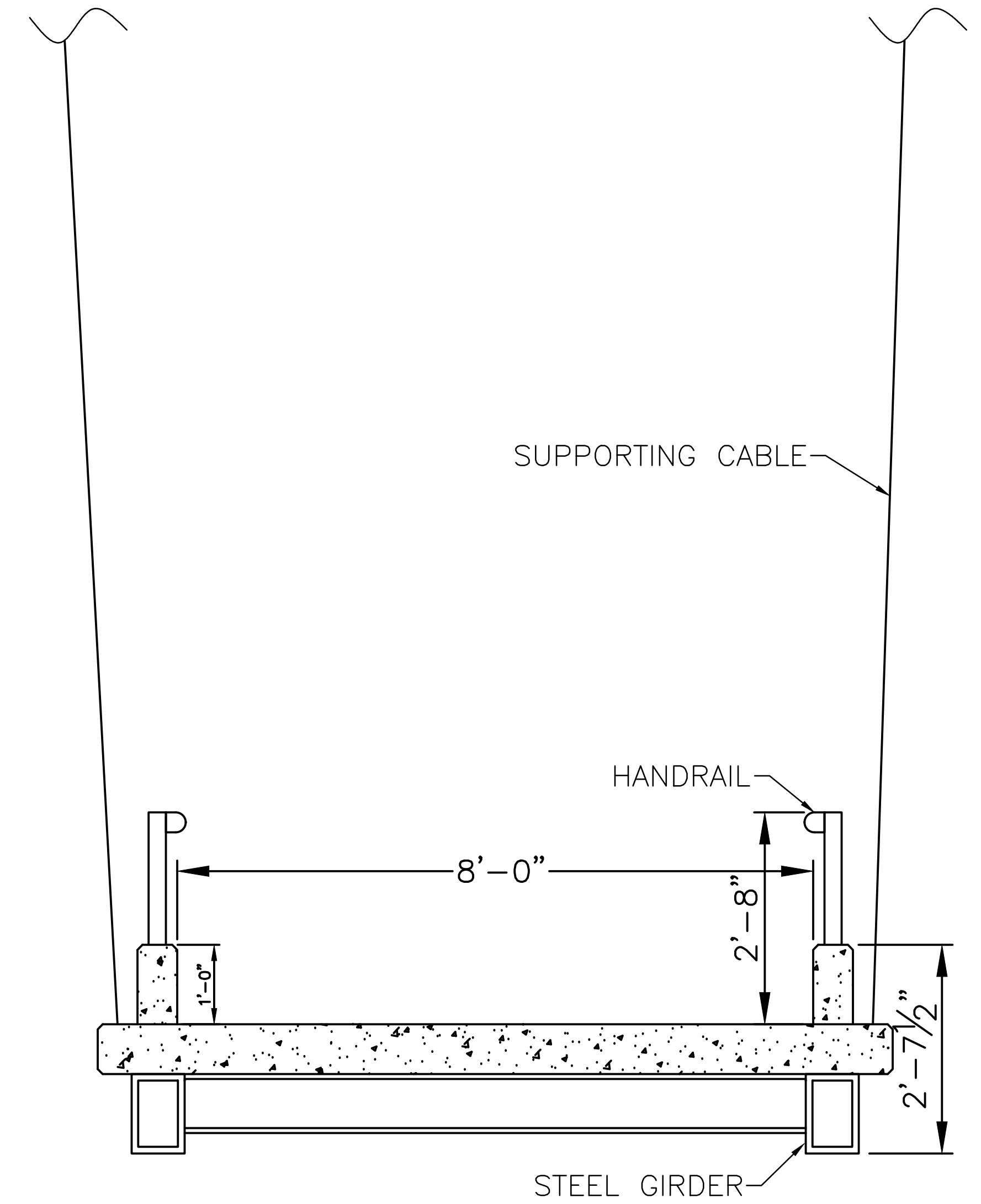

RAMP SECTION

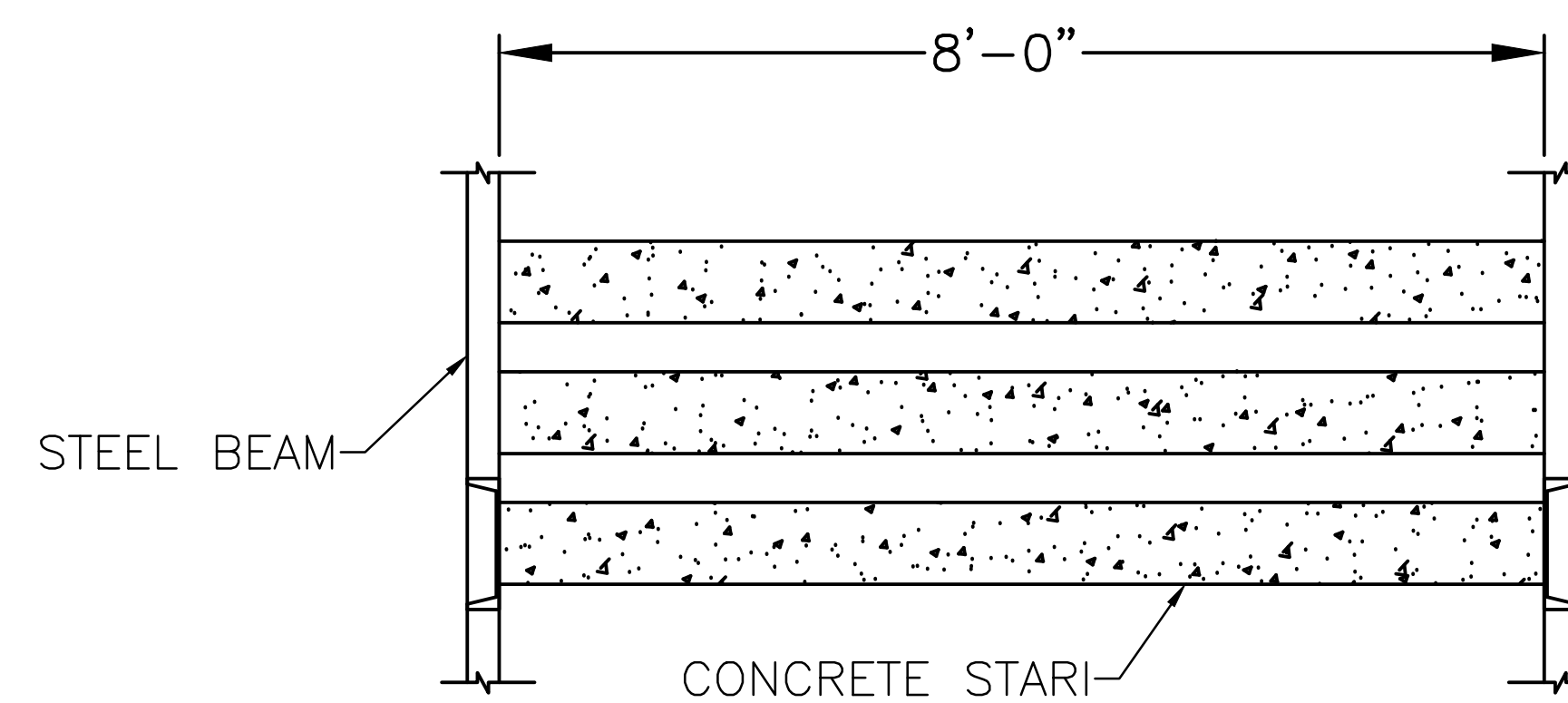

STAIR SECTION

PRELIMINARY NOT FOR CONSTRUCTION

>>>>CAUTION - CALL 811<<<<  
UTILITY NOTIFICATION CENTER  
BEFORE YOU DIG!  
WWW.CALL811.COM

Also, verify all underground utilities not located by the 811 service by using a commercial location service and call SPR Inspection Request Line (206) 684-7034.

7		
6		
5		
4		
3		
2		
1		
NO.	REVISION - AS BUILT	DATE

REVIEWED: \_\_\_\_\_ DATE \_\_\_\_\_  
PARK ENGINEER

All work done in accordance with the City of Seattle Standard Plans and Specifications in effect on the date shown above, and supplemented by Special Provisions.

**RHC ENGINEERING**  
WWW.RHCENGINEERING.COM  
720 3RD AVE SUITE 1400  
SEATTLE WA 98104  
PH: 206.623.5984



**Seattle Parks & Recreation**

**CARKEEK PARK  
PEDESTRIAN BRIDGE  
REPLACEMENT  
SECTIONS**

DESIGNED	JL
DRAWN	TL
CHECKED	GMC
ORDINANCE NO.	X
SPECIFICATION NO.	X
SCALE	X

DATE 03/05/2021

SHEET 4 OF 4

Sht. No.