

Certificate of Approval Application for La Quinta Apartments 1710 E Denny Way

Project Owner:

DEP Holdings I, LLC
1401 E Jefferson St, Ste 503
Seattle, WA 98122
Cao Huynh
cao@dephomes.com
206.322.1241

City Historic Preservation Officer:

Erin Doherty
Landmarks Preservation Program
Erin.Doherty@seattle.gov
206.684.0380

Project Contact:

Pollard Development Company
Michael Pollard
michael@pollarddevelopment.com
206.818.2595

Controls and Incentives Agreement executed 9/27/2021

Ordinance 126567, King County Recording #20220506001548; re-recorded #20220829001163

Certificate of Approval Request Narrative

- Installation of new 6" stormwater drainage pipe. Pipe is to be located in landscaping, run through the La Quinta basement, and buried in La Quinta crawlspace. Pipe exits the site to the south to connect to the drainage main in E Denny Way.
- The stormwater pipe serves a proposed new apartment building located on the same property as La Quinta. The new apartment building utilizes zoning incentives provided in the code for properties that contain Landmarked buildings. The La Quinta property was merged with 2 parcels to the north, creating the current configuration of one large parcel.
- The La Quinta building spans from property line to property line, precluding alternative utility access around the building to connect to the drainage main in E Denny Way. Constructing a new drainage main in 17th Ave E is economically unviable.
- The pipe will be below-grade, and **will not impact any of the controlled features**
 - Installation requires limited trenching. All landscaping will be repaired to prior existing condition.
 - Installation requires (2) 8" core holes through existing 8" concrete basement wall below-grade level. Pipe will be surface mounted to interior face of wall in rear of basement storage area.
 - Pipe penetrations at basement walls will be sealed meeting or exceeding industry standard waterproofing practices. See Link-Seal Product Data
 - Installation may require temporary support of wood staircase that leads to caretaker unit, but if needed, the stairs will be repaired to prior existing condition.
 - Ongoing pipe maintenance is allowed by exterior accessed 'cleanouts' located at various points along the proposed pipe. Cleanouts are commonly used for inspection and maintenance of utility pipes. Repair can be accomplished by the same methods as initial installation, or by non-invasive relining.

Additional Notes

- Stormwater drainage pipe has been designed by Civil Engineer for exterior portions of pipe and Plumbing Engineer for portions of pipe underneath building
- SPU has confirmed that the private pipe is not allowed to run around the building, in the right of way. The only alternative is a lengthy public drainage main extension in 17th Ave E, which is cost prohibitive. SPU Codes and Policies allow for the parcel to make a connection to the main in E Denny, and do not otherwise require a public main extension.
- Structural Engineer has evaluated existing basement wall condition and approved (2) 8” core holes
- SDCI Drainage and SPU have provided conceptual approval
- King County Public Health – Plumbing and Gas Piping Program have provided conceptual approval
- The Stormwater pipe is projected to convey 4.9 gpm in a worst-in-2-years storm event, up to 89 gpm in a 100-year storm event. The pipe is rated for approximately 160 gpm.
- Controls And Incentives Agreement lists Underground Utilities as exempt from requiring Certificate of Approval. The focus of this CoA request is for the (2) pipe penetrations and seals through the basement walls.
- The alternative to connecting a drainage pipe under the building and through the basement is a stormwater drainage main extension in 17th Ave E. This typically costs on the order of \$1,500 per lineal foot, which equates to approximately \$400,000, plus an additional \$75,000-\$100,000 in engineering, permitting, financing and management costs. This is an economically unviable alternative. This extension is not otherwise required by SPU.

Aerial Overview



Photo Source: La Quinta Nomination Report: Page A.4 Figure 4

Courtyard View - A



Landscaping to be restored

Approximate pipe location

Approximate trench location and size

Photo Source: La Quinta Nomination Report: Page A.6 Figure 8

North Yard View - B



Photo Source: SHW Architects

Under Stairs View - C



Wood stairs to be temporarily supported as needed

Approximate trench location and size

Approximate pipe location

Photo Source: Pollard Development Company

CAD FILE NUMBER: P:\CLIENTS\CIVIL\SEATTLE\DRAWINGS\1710 E DENNY WAY SEATTLE, DCI.DWG
 LAST MODIFIED BY: NICK - SAVE DATE: 9/20/2023 11:45 AM - SHEET SET: 1710 E DENNY WAY SEATTLE, DCI - ORIGINAL SHEET SIZE: ARCH FULL BLEED D (36.00 X 24.00 INCHES)
 PROJECT MANAGER: NA DESIGNED BY: FA DRAWN BY: MH CHECKED BY: MA

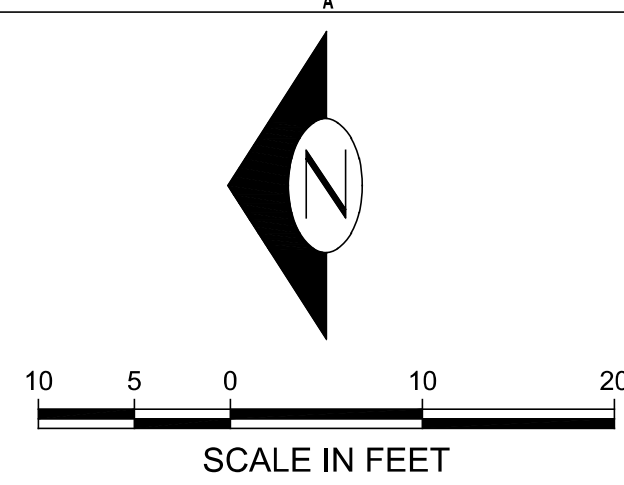

LEGEND:

	CONCRETE
	CONCRETE ROADWAY
	ASPHALT
	LANDSCAPE

ABBREVIATIONS:

BP	= BIOPLANTER
BOTS	= BOTTOM OF STAIR
BOTW	= FG @ BOTTOM OF WALL
EOP	= EDGE OF PAVEMENT
EG	= EXISTING GRADE
TOP	= TOP OF PAVEMENT
TOPS	= TOP OF STAIR
TOPW	= TOP OF WALL

KEY NOTES		
KEY	NOTE	DETAIL/SHEET
1	6" SDCO RIM 419.0± 6" IE 417.00	-
2	115 LF 6" SD PIPE @ 2.00% BURIED IN TRENCH WITHIN THE BUILDING FOOTPRINT, PIPE MATERIAL SHALL BE NO-HUB CAST IRON PIPE PER ASTM 888 AND CISPI 301.	-
3	6" SDCO RIM 420.00± 6" IE 414.70	-
4	63 LF 6" SD @ 7.2% SLOPE, ADD VERTICAL BENDS AS NECESSARY	-
5	NEW 6" SD CONNECT TO EX 12" PSD 6" SD IE 410.12 EX 12" PSD IE 409.12± CONTRACTOR TO POTHOLE AND CONFIRM THE DEPTH OF EX 12" PSD PRIOR TO TRENCHING IN ROADWAY	-
6	TREE PROTECTION FENCING FOR TREE IN PLANTING STRIP	COS STD PLAN 132A
7	INSTALL THROUGH FOUNDATION WALL TO CRAWL SPACE/STORAGE ROOM	-
8	APPROXIMATE CRAWLSPACE GRADE	-
9	INSTALL CLEANOUT OUTSIDE OF APARTMENT BUILDING FOUNDATION (TYP)	-
10	FOOTING AND STEM WALL PER STRUCTURAL ASBUILTS (APPROXIMATE), CONTRACTOR TO CONFIRM DEPTH OF FOOTING PRIOR TO WALL PENETRATION	-
11	PROTECT EX GATE/ARCH IN PLACE	-
12	EX APARTMENT BASEMENT STORAGE ROOM	-
13	MOUNT PIPING TO STORAGE ROOM WALL, HANGERS PROVIDED PER UPC	-
14	BURIED SECTION BENEATH APARTMENT BUILDING	-
15	EX FENCE TO REMAIN UNDISTURBED	-
16	EX STAIRS TO REMAIN UNDISTURBED	-
17	EX PATHWAYS TO BE REPLACED IN-KIND	-

NOTE:
DUE TO DEFLECTED ALIGNMENT, LENGTHS IN PROFILE VIEW MAY BE SKEWED

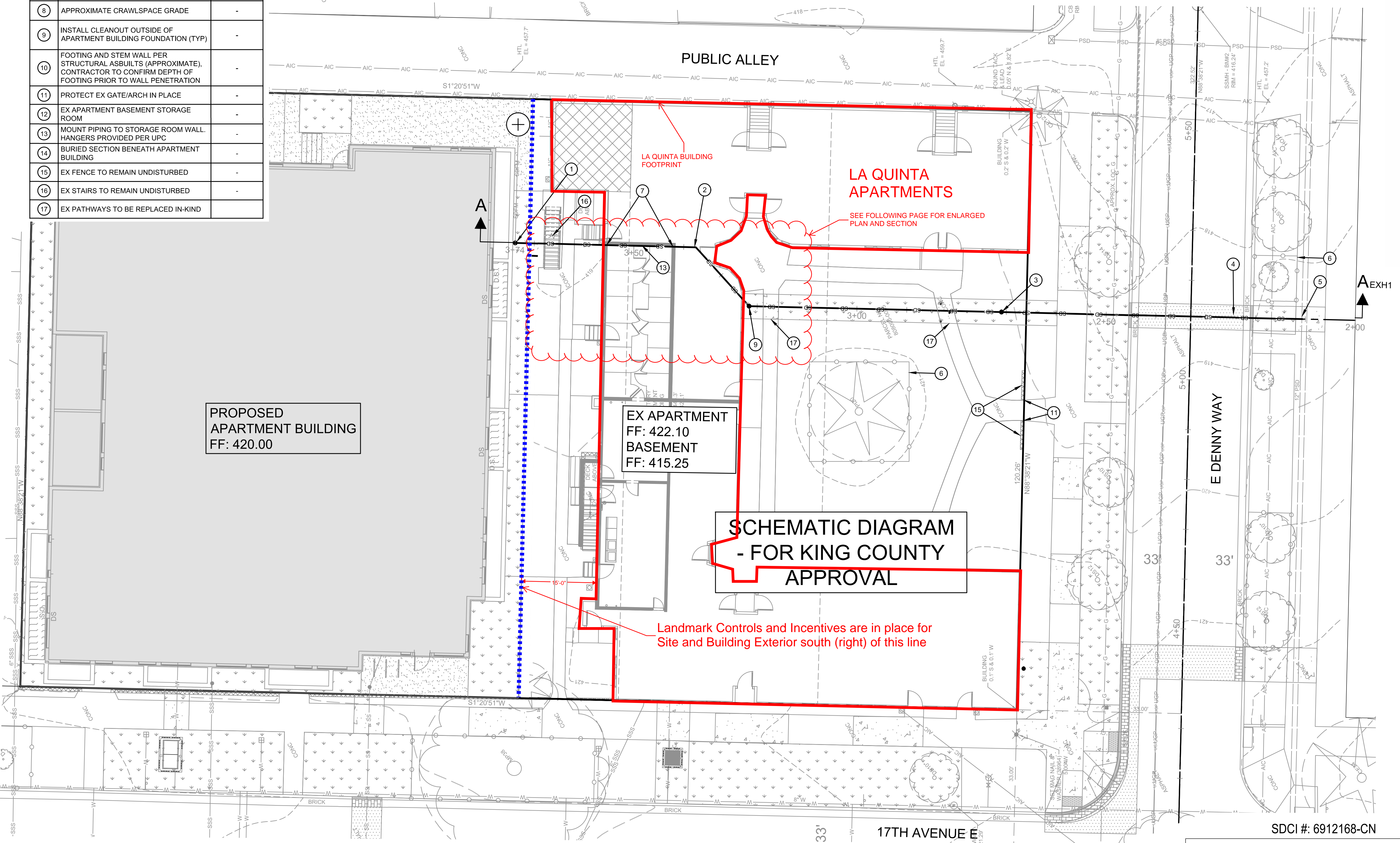
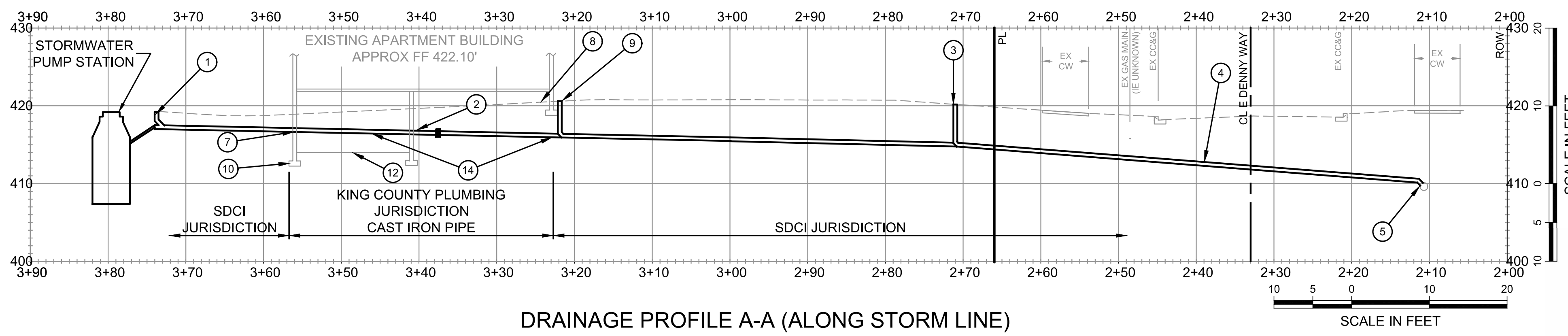

DRAINAGE PLAN & PROFILE

SDCI APPROVAL STAMP

 DIG WATERSHED 9706 4th Ave NE Suite 300 Seattle, WA 98115 P: 206.523.0024 www.digwatershed.com	NO. DATE BY REVISION
	CALL 811 2 BUSINESS DAYS BEFORE YOU DIG (UNDERGROUND UTILITY LOCATIONS ARE APPROX.)
 KEVIN L. YAMADA STATE OF WASHINGTON LICENSED PROFESSIONAL ENGINEER REG. NO. 47428	DATE: 20/09/2023 PLAN NUMBER:
1710 E DENNY WAY SDCI PLANS 1710 E DENNY WAY SEATTLE, WA 98122 2207.0177.00	SHEET 1 OF 5

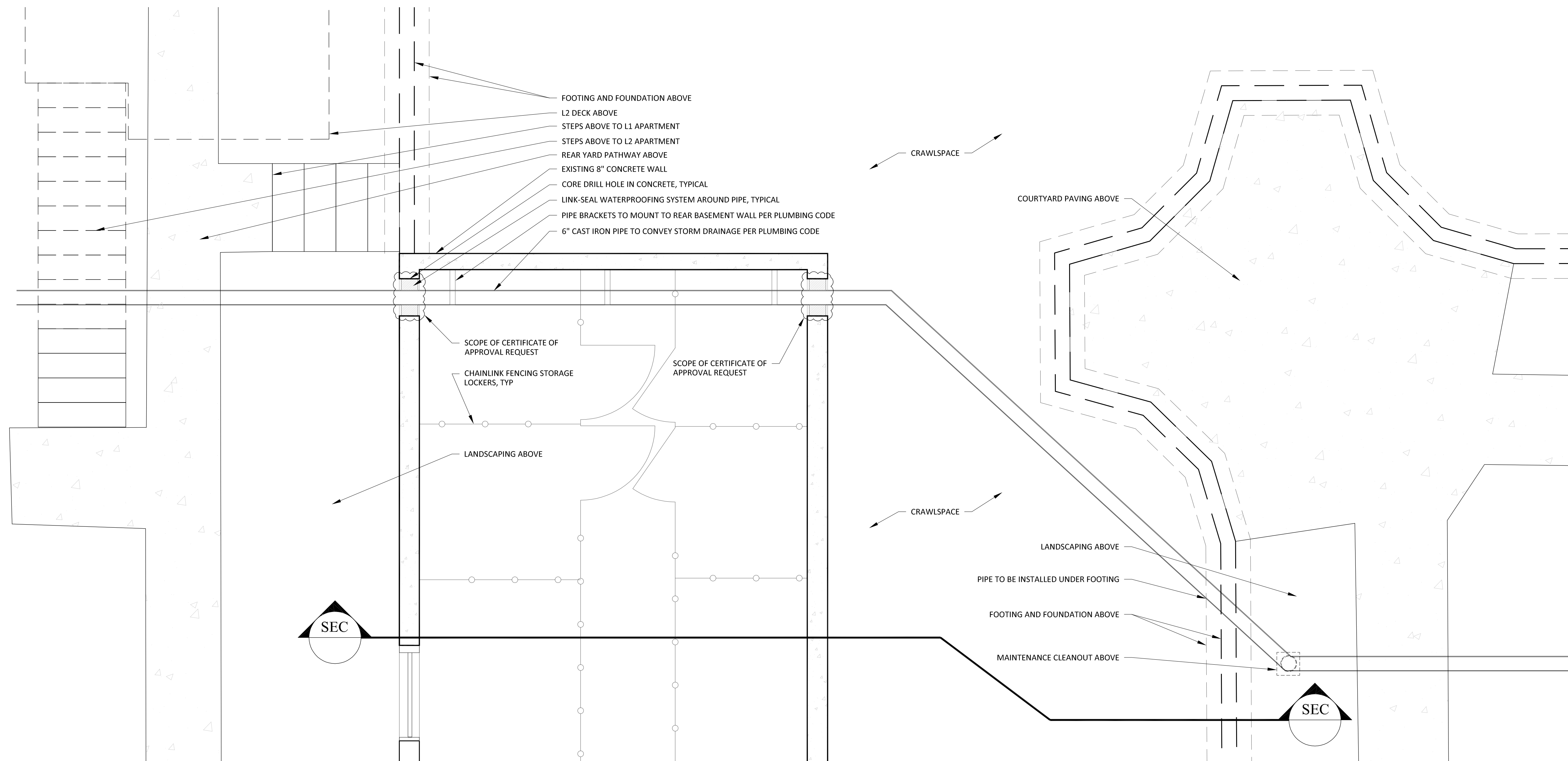

ENLARGED BASEMENT PLAN WITH EXTERIOR SITE PLAN OVERLAY

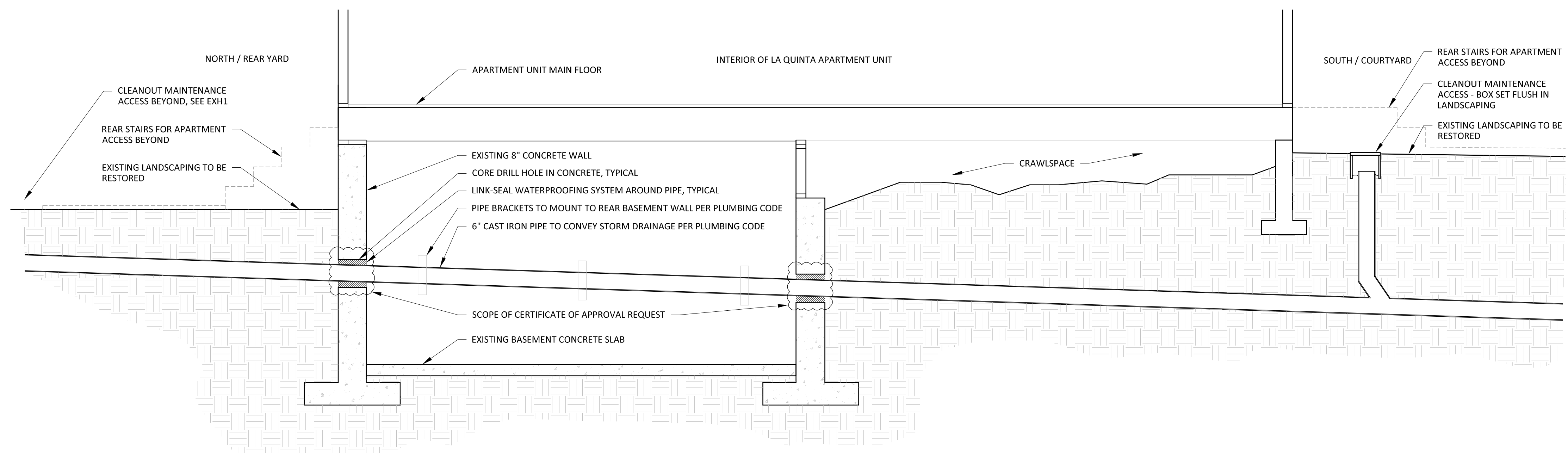

BUILDING SECTION THROUGH BASEMENT

CAD FILE NUMBER: P:\CLIENTS\CIVIL\SEATTLE\DRAWINGS\1710 E DENNY WAY SEATTLE, DCI.DWG
 LAST MODIFIED BY: NICK - SAVE DATE: 9/20/2023 11:45 AM - SHEET SET: 1710 E DENNY WAY SEATTLE, DCI - ORIGINAL SHEET SIZE: ARCH FULL BLEED D (36.00 X 24.00 INCHES)
 PROJECT MANAGER: NA DESIGNED BY: FA DRAWN BY: MH CHECKED BY: MA

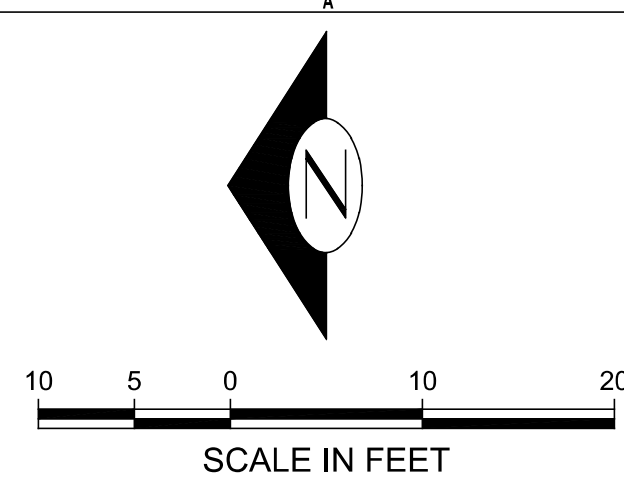

LEGEND:

	CONCRETE
	CONCRETE ROADWAY
	ASPHALT
	LANDSCAPE

ABBREVIATIONS:

BP	= BIOPLANTER
BOTS	= BOTTOM OF STAIR
BOTW	= FG @ BOTTOM OF WALL
EOP	= EDGE OF PAVEMENT
EG	= EXISTING GRADE
TOP	= TOP OF PAVEMENT
TOPS	= TOP OF STAIR
TOPW	= TOP OF WALL

KEY NOTES		
KEY	NOTE	DETAIL/SHEET
1	6" SDCO RIM 419.0± 6" IE 417.00	-
2	115 LF 6" SD PIPE @ 2.00% BURIED IN TRENCH WITHIN THE BUILDING FOOTPRINT, PIPE MATERIAL SHALL BE NO-HUB CAST IRON PIPE PER ASTM 888 AND CISPI 301.	-
3	6" SDCO RIM 420.00± 6" IE 414.70	-
4	63 LF 6" SD @ 7.2% SLOPE, ADD VERTICAL BENDS AS NECESSARY	-
5	NEW 6" SD CONNECT TO EX 12" PSD 6" SD IE 410.12 EX 12" PSD IE 409.12± CONTRACTOR TO POTHOLE AND CONFIRM THE DEPTH OF EX 12" PSD PRIOR TO TRENCHING IN ROADWAY	-
6	TREE PROTECTION FENCING FOR TREE IN PLANTING STRIP	COS STD PLAN 132A
7	INSTALL THROUGH FOUNDATION WALL TO CRAWL SPACE/STORAGE ROOM	-
8	APPROXIMATE CRAWLSPACE GRADE	-
9	INSTALL CLEANOUT OUTSIDE OF APARTMENT BUILDING FOUNDATION (TYP)	-
10	FOOTING AND STEM WALL PER STRUCTURAL ASBUILTS (APPROXIMATE), CONTRACTOR TO CONFIRM DEPTH OF FOOTING PRIOR TO WALL PENETRATION	-
11	PROTECT EX GATE/ARCH IN PLACE	-
12	EX APARTMENT BASEMENT STORAGE ROOM	-
13	MOUNT PIPING TO STORAGE ROOM WALL, HANGERS PROVIDED PER UPC	-
14	BURIED SECTION BENEATH APARTMENT BUILDING	-
15	EX FENCE TO REMAIN UNDISTURBED	-
16	EX STAIRS TO REMAIN UNDISTURBED	-
17	EX PATHWAYS TO BE REPLACED IN-KIND	-

NOTE:
DUE TO DEFLECTED ALIGNMENT, LENGTHS IN PROFILE VIEW MAY BE SKEWED

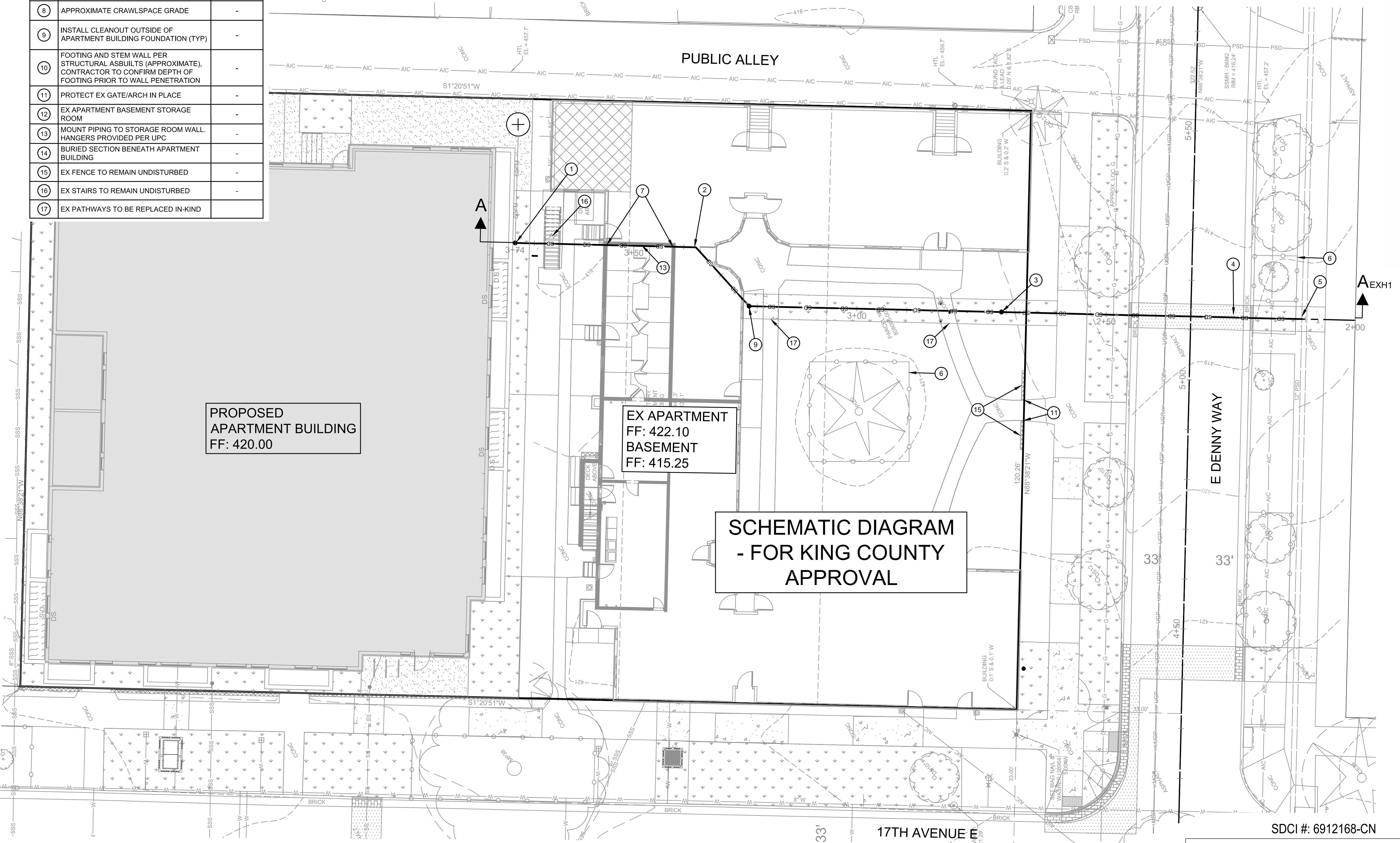
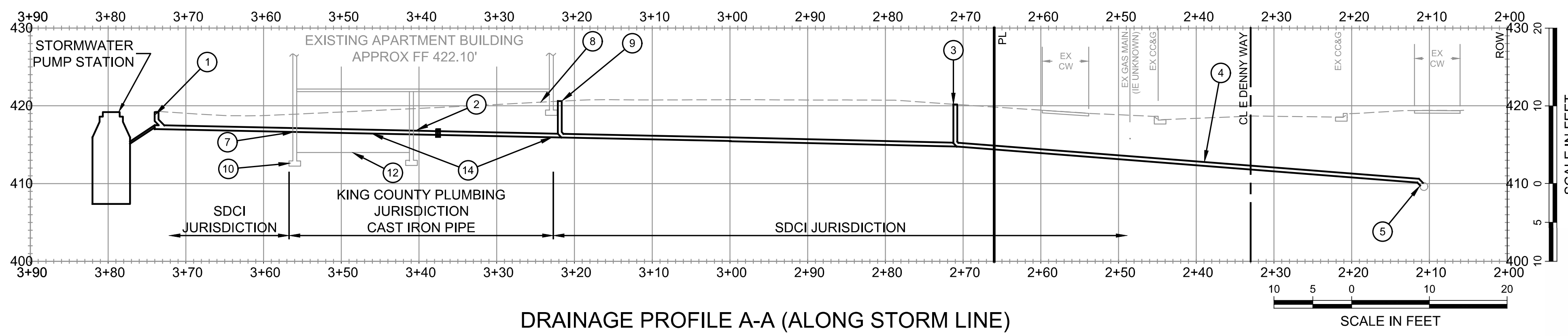

DRAINAGE PLAN & PROFILE

SDCI APPROVAL STAMP

 DIG WATERSHED 9706 4th Ave NE Suite 300 Seattle, WA 98115 P: 206.523.0024 www.digwatershed.com	NO. DATE BY REVISION
	DATE: 20/09/2023 PLAN NUMBER: EXH1 SHEET 1 OF 5
 KEVIN L. YAMADA STATE OF WASHINGTON REGISTERED PROFESSIONAL ENGINEER No. 47428 EXPIRES 12/31/2025	CALL 811 2 BUSINESS DAYS BEFORE YOU DIG (UNDERGROUND UTILITY LOCATIONS ARE APPROX.)
1710 E DENNY WAY SDCI PLANS 1710 E DENNY WAY SEATTLE, WA 98122 2207.0177.00	SDCI # : 6912168-CN

Selection Guide

Experience Counts

PROPOSED SEAL AROUND PIPE AT
BASEMENT WALL CORE DRILL HOLE

LINK-SEAL® MODULAR SEALS

CENTURY-LINE® SLEEVES

CELL-CAST® DISKS



50 years and still sealing



Experience Counts - Use the Original

CONTENTS

The System is the Solution 5
 Features 5
 Applications 5
 Sizing Procedure 12-16
 LINK-SEAL® Installation 17
 CENTURY-LINE® Installation 18
 CELL-CAST® Installation 19

LINK-SEAL® MODULAR SEALS

Properties 6-8
 Bolt & Nut Specifications 8

CENTURY-LINE® SLEEVES

Features 9
 Weights and Dimensional Data 9

CELL-CAST® Disks

Features 10
 Weights and Dimensional Data 10

WS STEEL WALL SLEEVES

Weights, Dimensional Data and Specifications 11

SIZING PROCEDURE

Steel & Plastic 12
 SDR-35 Gravity Sewer Pipe 13
 Ductile Iron Pipe 13
 Cast Iron Soil Pipe (Extra Heavy) 14
 Cast Iron Soil Pipe (Service Weight) 14
 Electrical Metallic Tubing 15
 Intermediate Metal Conduit 15
 Rigid, Aluminum, Galvanized, Non-Metallic Conduit 16
 Copper Tubing 16

INSTALLATION

LINK-SEAL® Modular Seals 17
 CENTURY-LINE® Sleeves 18
 CELL-CAST® Disks 19

Typical Specifications 20
 FAQ 21
 LINK-SEAL® Technical Approvals 22
 Product Ordering Code 23

Performance data included in this manual is intended for guideline purposes only. Performance suitability for any specific application should be determined by the end user. Variation in temperature, pressure, concentration or mixtures acting synergistically may preclude recommended service use.

CAD drawings (.dwg) are available on-line. Drawings can be downloaded and inserted into Auto-CAD for drawing plans. Submittal sheets can also be accessed in a PDF file. Contact Garlock or your local authorized distributor for support and purchasing information.

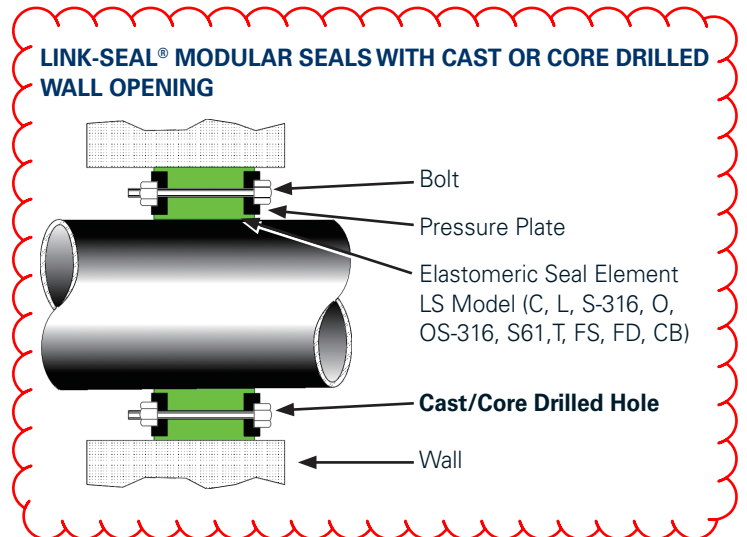

LINK-SEAL® MODULAR SEALS WITH MODEL WS STEEL WALL SLEEVES

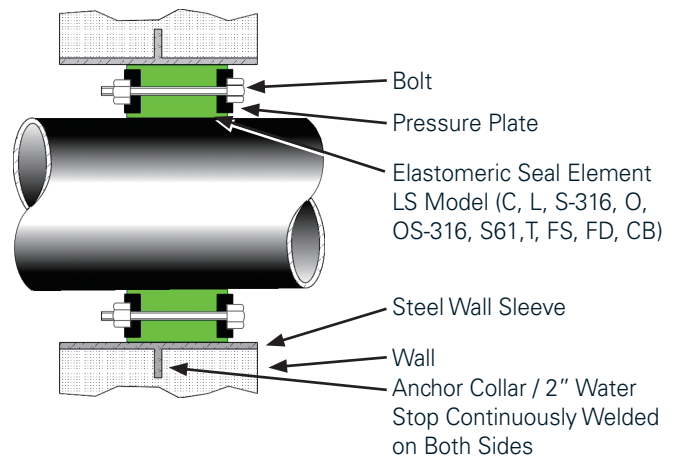

LINK-SEAL® MODULAR SEALS WITH CENTURY-LINE® SLEEVES

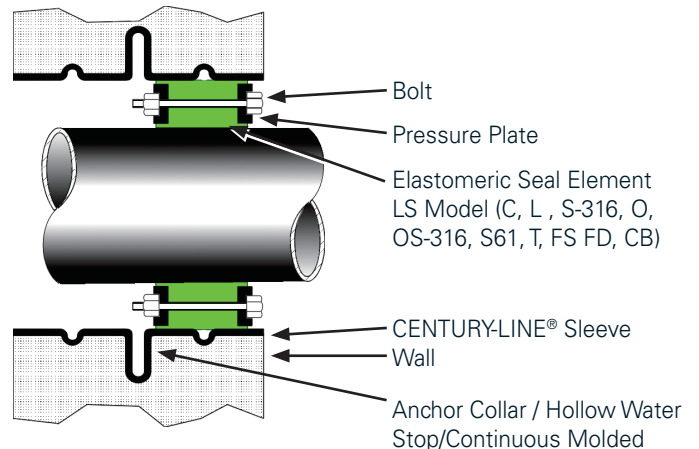

The System is the Solution

LINK-SEAL® MODULAR SEALS

The best way to permanently seal any cylindrical object, of any size, passing through any type of concrete barrier (wall, floor or ceiling) is to use LINK-SEAL® modular seals. From ductile iron to pre-stressed concrete to metal or plastic pipe, conduit or cables - whatever your application - LINK-SEAL® modular seals will affect a hydrostatic seal capable of holding 20 psig (40 feet of static head) between the pipe and the penetration cylinder through which the pipe passes.

IN COMBINATION WITH CENTURY-LINE® SLEEVES

The best way to guarantee a perfect seal is to use CENTURY-LINE® sleeves with LINK-SEAL® modular seals. They're engineered and sized to provide a stable hole that matches dimensionally with LINK-SEAL® modular seals. It makes ordering quick and easy and guarantees a perfect fit - and seal - each and every time.

CELL-CAST® DISKS

For larger holes in poured concrete structures, (29.25" to 64.75"Ø) CELL-CAST® disks are used to produce a dimensionally stable hole and smooth concrete surface that is perfect for use with LINK-SEAL® modular seals.



Features

SAVES TIME AND MONEY

LINK-SEAL® modular seals install in up to 75% less time compared to hand fitting flashings, mastics or casing boots.

POSITIVE HYDROSTATIC SEAL

LINK-SEAL® modular seals are rated at 20 psig (40 feet of static head), which exceeds the performance requirements of most applications.

LONG SEAL LIFE

LINK-SEAL® modular seals are designed for use as a permanent seal. Seal elements are specially compounded to resist aging and attack from ozone, sunlight, water and a wide range of chemicals.

MAXIMUM PROTECTION AGAINST CORROSION

Standard fasteners have a proprietary corrosion inhibiting coating. Corrosion resistant 316 stainless steel hardware selected for maximum corrosion protection.

ISO QUALITY ASSURANCE

LINK-SEAL® modular seals are manufactured in an ISO 9001:2015 certified facility.

CONFIGURE A LINK-SEAL® MODULAR SEAL TO MATCH YOUR APPLICATION

16 sizes, color coded EPDM, Nitrile, & Silicone elastomers may be used with various hardware options to match performance characteristics with service conditions.

LINK-SEAL® Modular Seal Applications

- » Mechanical Contractors - Interior & Exterior Piping Systems
- » Manhole Pipe Entry Seals
- » Waste Treatment Plants
- » Cased Road Crossings
- » Thermal Storage Systems
- » Fire Protection Wall Penetrations
- » Cased Railroad Crossings
- » Electrical Isolation of Pipes
- » Precast Concrete Vault Seals
- » Insulated Pipe Seals
- » Dual Containment Seals
- » Marine Applications
- » Noise Dampening
- » Flexible Sign & Pole Supports
- » Electrical Isolation of Pipe Supports
- » Mining
- » Pulp & Paper
- » Decorative Fountains
- » Pool Contractors
- » Electrical Contractors
- » Waste Water & Water Treatment Plants
- » Telecommunications
- » Valve Pits
- » Refrigeration Buildings
- » Guard Post Assemblies
- » Power Generation Dams
- » Offshore Oil Rigs
- » High Pressure Tank Guards
- » Underground Steel Tanks
- » Precast Concrete Manufacturers
- » Perimeter Berm Installations Around Tank Farms
- » Flow Restrictions in Sewer Maintenance
- » Fluid Overflow Devices
- » Noise and Sway Dampener
- » Through Deck Fire Breaks
- » Bridge Construction
- » Septic Tank Installations
- » Coal Preparation Plants
- » Tunneling Operations

LINK-SEAL® Modular Seal Model Properties

WITH EPDM SEAL ELEMENTS



EPDM (BLACK)

* = Sustained operation near temperature limits may affect life expectancy.

MODEL "C" LINK-SEAL® MODULAR SEAL

Suitable for normal atmospheric conditions and conditions with occasional or periodic water contact. Provides electrical isolation where cathodic protection is required.

Type: Standard
 Seal Element: EPDM (Black)
 Pressure Plates: Reinforced Nylon Polymer
 Bolts & Nuts: Carbon steel with corrosion inhibiting proprietary organic coating.
 Temp. Range: -40° - +250°F (-40° - +121°C)*

MODEL "S-316" LINK-SEAL® MODULAR SEAL

For direct water contact, chemical processing & waste water treatment. High level of water-resistance, resistant to most inorganic acids and alkalis, and most organic chemicals (acetone, alcohol, ketones).

Type: Stainless
 Seal Element: EPDM (Black)
 Pressure Plates: Reinforced Nylon Polymer
 Bolts & Nuts: 316 Stainless Steel
 Temp. Range: -40° - +250°F (-40° - +121°C)*

WITH EPDM SEAL ELEMENTS



EPDM (BLUE)

Low Durometer

* = Sustained operation near temperature limits may affect life expectancy.

MODEL "L" LINK-SEAL® MODULAR SEAL

Low Durometer EPDM specifically designed for use with fragile pipe and tubing. Suitable for normal atmospheric conditions and conditions with occasional or periodic water contact. Provides electrical isolation where cathodic protection is required.

Type: Standard
 Seal Element: EPDM (Blue)
 Pressure Plates: Reinforced Nylon Polymer
 Bolts & Nuts: Carbon steel with corrosion inhibiting proprietary organic coating.
 Temp. Range: -40° - +250°F (-40° - +121°C)*

MODEL "LS-316" LINK-SEAL® MODULAR SEAL

Low Durometer EPDM specifically designed for use with fragile pipe and tubing. For chemical processing & waste water treatment. High level of water-resistance, resistant to most inorganic acids and alkalis, and most organic chemicals (acetone, alcohol, ketones).

Type: Stainless
 Seal Element: EPDM (Blue)
 Pressure Plates: Reinforced Nylon Polymer
 Bolts & Nuts: 316 Stainless Steel
 Temp. Range: -40° - +250°F (-40° - +121°C)*

WITH NITRILE SEAL ELEMENTS



NITRILE (GREEN)

* = Sustained operation near temperature limits may affect life expectancy.

MODEL "O" LINK-SEAL® MODULAR SEAL

Nitrile rubber is resistant to oils, fuel and many solvents (gasoline, motor oil, kerosene, methane, jet fuel, hydraulic fluid, water, etc.).

Type: Oil Resistant
 Seal Element: Nitrile (Green)
 Note: Not U.V. Resistant
 Pressure Plates: Reinforced Nylon Polymer
 Bolts & Nuts: Carbon steel with corrosion inhibiting proprietary organic coating.
 Temp. Range: -40° - +210°F (-40° - +99°C)*

MODEL "OS-316" LINK-SEAL® MODULAR SEAL

Combination of oil resistant rubber and stainless steel hardware.

Type: Oil Resistant
 Seal Element: Nitrile (Green)
NOTE: Not U.V. Resistant
 Pressure Plates: Reinforced Nylon Polymer
 Bolts & Nuts: 316 Stainless Steel
 Temp. Range: -40° - +210°F (-40° - +99°C)*

LINK-SEAL® Modular Seal Model Properties

MATERIAL PROPERTIES OF LINK-SEAL® MODULAR SEAL ELEMENTS

Property	ASTM Method	EPDM (EPDM L)	Nitrile	Silicone
Hardness (shore A)	D-2240	50 ±5 (40 ±5)	50 ±5	50 ±5
Tensile	D-412	1450 psi	1300 psi	860 psi
Elongation	D-412	400%	300%	250%
Compression Set	S-395	15% 22 hrs. @ 158° F (70° C)	45% 22 hrs. @ 212° F (100° C)	40% 22 hrs. @ 350° F (177° C)
Specific Gravity	D-297	1.10	1.15	1.40

MATERIAL PROPERTIES OF COMPOSITE PRESSURE PLATES

Property	ASTM Method	Value
Izod Impact - Notched	D-256	1.11 ft-lb/in
Tensile Strength @ Yield	D-638	20,000 psi
Tensile Strength - Break	D-638	20,250 psi
Flexural Strength @ Yield	D-790	30,750 psi
Flexural Modulus	D-790	1,124,000 psi
Elongation, Break	D-638	11.07%
Specific Gravity	D-792	1.38
Moisture Content	--	0.18%

BOLT & NUT SPECIFICATION

» Carbon Steel



- › Carbon steel with a corrosion inhibiting proprietary organic coating. (passes 1470 hour salt spray test)
- › Tensile Strength = 60,000 psi, minimum.

An independent 1,470 hour salt spray test run in accordance to ASTM B117-97 has proven LINK-SEAL® modular seals' Carbon Steel bolts, with proprietary corrosion inhibiting coating, to be superior when compared with competitive manufactures.

» Stainless Steel

- › ANSI Type = 316, Per ASTM F593-95
- › Tensile Strength = 85,000 psi, average



LINK-SEAL® Model	Tool Size/ Type Req.	Bolt Head Type
LS-200, LS-275	4mm, Allen	
LS-300, LS-315	6mm, Allen	
LS-325, LS-340, LS-360	13mm, Hex	
LS-400, LS-410, LS-425, LS-475	17mm, Hex	
LS-500, LS-525, LS-575, LS-650	19mm, Hex	
LS-615	24mm, Hex	

To provide consistency and worldwide compatibility, Garlock now offers all LINK-SEAL® Modular Seal sizes with metric bolts. The new bolts adhere to metric specifications as used by most all countries outside the U.S.A. Smaller LINK-SEAL® Modular Seals (sizes LS-200, LS-275, LS-300, and LS-315) will consist of metric Allen head or socket cap bolt heads while the balance of the line will use standard hex head metric bolts.

Sizing Procedure

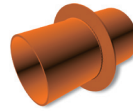

CAST IRON SOIL PIPE (EXTRA HEAVY)

Pipe Size (Nom.)	Actual O.D. (Inches)	CENTURY-LINE® SLEEVE			STEEL SLEEVE			CAST OR CORE BIT DRILLED HOLE		
		Model Number	LINK-SEAL® Size	Links Per Seal	Model Number	LINK-SEAL® Size	Links Per Seal	Hole I.D.	LINK-SEAL® Size	Links Per Seal
2	2.380	CS-4-*	LS-300-***	6	WS-3-½-22-S-*	LS-200-***	8	4.000	LS-300-***	6
3	3.500	CS-5-*	LS-315-***	9	WS-6-28-S-*	LS-360-***	7	5.000	LS-300-***	8
4	4.500	CS-8-*	LS-475-***	8	WS-6-28-S-*	LS-300-***	10	6.000	LS-300-***	10
5	5.500	CS-8-*	LS-360-***	10	WS-8-32-S-*	LS-340-***	13	8.000	LS-340-***	13
6	6.500	CS-8-*	LS-315-***	15	WS-10-36-S-*	LS-475-***	10	10.000	LS-475-***	10
8	8.620	CS-12-*	LS-475-***	12	WS-12-37-S-*	LS-475-***	12	12.000	LS-475-***	12
10	10.750	CS-14-*	LS-410-***	15	WS-14-37-S-*	LS-425-***	10	14.000	LS-475-***	14
12	12.750	CS-16-*	LS-475-***	17	WS-16-37-S-*	LS-425-***	12	16.000	LS-475-***	17
15	15.880	CS-20-*	LS-410-***	21	WS-20-37-S-*	LS-475-***	20	18.000	LS-340-***	33

= Specify sleeve length in inches ** = See CELL-CAST® Page 25 *** = Specify LS Model C, S-316, L...etc when ordering (Example LS-475-C-17)

CAST IRON SOIL PIPE (SERVICE WEIGHT)

Pipe Size (Nom.)	Actual O.D. (Inches)	CENTURY-LINE® SLEEVE			STEEL SLEEVE			CAST OR CORE BIT DRILLED HOLE		
		Model Number	LINK-SEAL® Size	Links Per Seal	Model Number	LINK-SEAL® Size	Links Per Seal	Hole I.D.	LINK-SEAL® Size	Links Per Seal
2	2.300	CS-4-*	LS-300-***	6	WS-4-23-S-*	LS-315-***	6	4.000	LS-315-***	6
3	3.300	CS-5-*	LS-300-***	8	WS-6-28-S-*	LS-360-***	7	5.000	LS-300-***	8
4	4.300	CS-6-*	LS-300-***	10	WS-6-28-S-*	LS-315-***	10	6.000	LS-300-***	10
5	5.300	CS-8-*	LS-410-***	8	WS-8-32-S-*	LS-360-***	9	8.000	LS-360-***	9
6	6.300	CS-8-*	LS-315-***	15	WS-8-32-S-*	LS-315-***	15	8.000	LS-315-***	15
8	8.380	CS-10-*	LS-325-***	9	WS-10-36-S-*	LS-315-***	19	10.000	LS-315-***	19
10	10.500	CS-14-*	LS-475-***	14	WS-14-37-S-*	LS-360-***	17	14.000	LS-475-***	14
12	12.500	CS-18-*	LS-500-***	12	WS-16-37-S-*	LS-360-***	20	16.000	LS-475-***	17
15	15.620	CS-20-*	LS-475-***	20	WS-20-37-S-*	LS-475-***	20	18.000	LS-425-***	14

= Specify sleeve length in inches ** = See CELL-CAST® Page 25 *** = Specify LS Model C, S-316, L...etc when ordering (Example LS-475-C-17)

Installation Techniques - LINK-SEAL® Modular Seals

1. Center the pipe, cable or conduit in wall opening or casing. Make sure the pipe will be adequately supported on both ends. LINK-SEAL® modular seals are not intended to support the weight of the pipe.

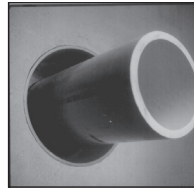

2. Loosen rear pressure plate with nut just enough so links move freely. Connect both ends of belt around the pipe.

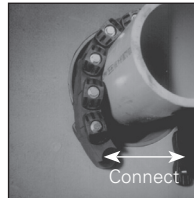

3. Check to be sure all bolt heads are facing the installer. Extra slack or sag is normal. Do not remove links if extra slack exists.



NOTE: On smaller diameter pipe, links may need to be stretched.

4. Slide belt assembly into annular space. For larger size belts, start inserting LINK-SEAL® modular seal assembly at 6 o'clock position and work both sides toward 12 o'clock position in annular space.

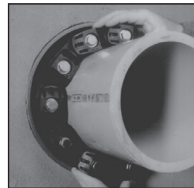

5. LS-200 through LS-315 Using a hand socket allen head or off-set wrench **ONLY**, start at 12 o'clock. Do not tighten any bolt more than 4 turns at a time. Continue in a clockwise manner until links have been uniformly compressed. (Approx. 2 or 3 rotations)

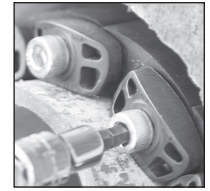

5a. LS-325 through LS-650 Using a hand socket or off-set wrench **ONLY**, start at 12 o'clock. Do not tighten any bolt more than 4 turns at a time. Continue in a clockwise manner until links have been uniformly compressed (Approx. 2 or 3 rotations).

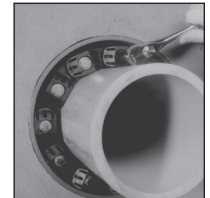

6. Make 2 or 3 more passes at 4 turns per bolt **MAXIMUM**, tightening all bolts clockwise until all sealing elements "bulge" around all pressure plates. On type 316 stainless steel bolts, hand tighten **ONLY** without power tool.

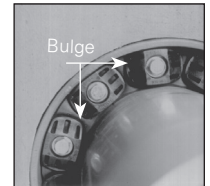

7. If the seal doesn't appear to be correct using the instructions provided, call Garlock at 1-800-423-2410.

Installation Notes: LINK-SEAL® modular seal bolt heads are usually recessed below wall opening or edge of casing pipe and therefore a socket or offset wrench must be used.



LINK-SEAL® MODULAR SEAL - DO'S

1. Make sure pipe is centered
2. Install belt with the pressure plates evenly spaced
3. Install exact number of links indicated in sizing charts
4. Check to make sure pipe is supported properly during backfill operations. Note: LINK-SEAL® modular seals are not intended to support the weight of the pipe
5. Make sure seal assembly and pipe surfaces are free from dirt
6. For tight fits, use non-polluting liquid detergent to assist installation

CORRECT

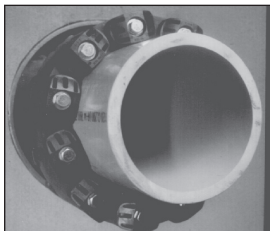

INCORRECT

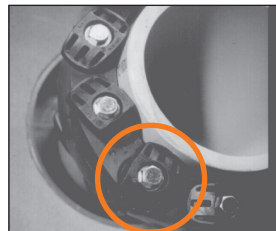

If the seal doesn't appear to be correct using the techniques provided, call Garlock at 1-800-423-2410.

Always wear appropriate PPE

LINK-SEAL® MODULAR SEAL - DON'TS

1. Don't install belt with the pressure plates aimed in irregular directions. (Staggered)
2. Don't install LINK-SEAL® modular seals where weld-beads or other irregular surfaces exist without consideration of the sealing requirements
3. Don't torque each bolt completely before moving on to the next
4. Don't use high speed power tools (450 rpm or more)
5. Do not use power tools on LINK-SEAL® modular seal 316 stainless steel bolts
6. Don't use grease installing LINK-SEAL® modular seals

LINK-SEAL® Model	Tool Size/ Type Req.	Bolt Head Type
LS-200, LS-275	4mm, Allen	
LS-300, LS-315	6mm, Allen	
LS-325, LS-340, LS-360	13mm, Hex	
LS-400, LS-410, LS-425, LS-475	17mm, Hex	
LS-500, LS-525, LS-575, LS-650	19mm, Hex	
LS-615	24mm, Hex	

Hand Tools: See provided chart above. (Tools not provided.) Tools can be purchased from hardware store, auto parts store, or home improvement store.