

**THIS COVER TO BE REPLACED WITH SPU COVER
IN THE CLEAN PDF**
CITY OF SEATTLE STORMWATER MANUAL

CITY OF SEATTLE
SEATTLE PUBLIC UTILITIES
DEPARTMENT OF CONSTRUCTION AND INSPECTION

July 2021

SDCI	Director's Rule 10-2021
SPU	Director's Rule DWW-200

Applicant: Department of Construction & Inspections Seattle Public Utilities	Page: 2 of 1121	Supersedes: SDCI: 17-2017 SPU: DWW-200 (2017)
	Publication: 03/23/2021	Effective: 07/01/2021
Subject: Stormwater Manual Volumes 1 to 5 Appendices A to I	Code and Section Reference: SMC 22.800-22.808	
	Type of Rule: Code interpretation	
	Ordinance Authority: SMC 3.06.040, 3.32.020	
Index: Title 22.800 Stormwater Code	Approved: _____ Nathan Torgelson, Director, SDCI	Date: _____
	Approved: _____ Mami Hara, General Manager/CEO, SPU	Date: _____

Note:

Some pages in this document have been purposely skipped or blank pages inserted so that this document will copy correctly when duplexed.

Table of Contents

- Volume 1 – Project Minimum Requirements
- Volume 2 – Construction Stormwater Control
- Volume 3 – Project Stormwater Control
- Volume 4 – Source Control
- Volume 5 – Enforcement

Appendices

- Appendix A – Definitions
- Appendix B – Additional Submittal Requirements
- Appendix C – On-site Stormwater List BMP Infeasibility Criteria
- Appendix D – Subsurface Characterization and Infiltration Testing for Infiltration BMPs
- Appendix E – Additional Design Requirements and Plant Lists
- Appendix F – Hydrologic Analysis and Design
- Appendix G – Stormwater Control Operations and Maintenance Requirements
- Appendix H – Financial Infeasibility Documentation for Vegetated Roofs and Rainwater Harvesting
- Appendix I – Landscape Management Plans and Integrated Pest Management Plans

With a publication of this size and complexity there will inevitably be errors that must be corrected and clarifications that are needed. There will also be new information and technological updates. The City intends to publish corrections, updates, and new technical information on our Stormwater Code website ([http://www.seattle.gov/sdci/codes/codes-we-enforce-\(a-z\)/stormwater-code](http://www.seattle.gov/sdci/codes/codes-we-enforce-(a-z)/stormwater-code)). The City will not use the website to make revisions in key policy areas - such as the thresholds and minimum requirements in Volume 1. Please check this site periodically for corrections and updates.

**THIS COVER TO BE REPLACED
WITH SPU-PROVIDED COVER**
VOLUME 1 —
PROJECT MINIMUM REQUIREMENTS

CITY OF SEATTLE
SEATTLE PUBLIC UTILITIES
DEPARTMENT OF CONSTRUCTION AND INSPECTION

July 2021

Note:

Some pages in this document have been purposely skipped or blank pages inserted so that this document will copy correctly when duplexed.

Table of Contents

CHAPTER 1 - Introduction.....	1-1
1.1. Purpose of This Manual (Volumes 1 through 5 and Appendices)	1-1
1.2. How to Use this Manual (Volumes 1 through 5 and Appendices)	1-2
1.3. Purpose of Volume 1	1-3
1.4. How to Use this Volume	1-3
CHAPTER 2 - Determining Minimum Requirements	2-1
2.1. Step 1 - Define the Boundaries of the Project Site	2-1
2.1.1. Definitions	2-2
2.1.2. Closely Related Projects	2-2
2.2. Step 2 - Identify the Type of Project	2-3
2.2.1. Single-Family Residential Project	2-4
2.2.2. Sidewalk Project	2-5
2.2.3. Trail Project.....	2-7
2.2.4. Roadway Project	2-8
2.2.5. Parcel-Based Project	2-10
2.2.6. Certain Land-Disturbing Activities.....	2-11
2.2.7. WSDOT Project.....	2-12
2.2.8. Special Circumstances Projects.....	2-12
2.3. Step 3 - Identify the Receiving Water and Downstream Conveyance	2-12
2.4. Step 4 - Perform Site Assessment and Planning	2-21
2.5. Step 5 - Calculate Land-Disturbing Activity and New Plus Replaced Hard Surface	2-21
2.6. Step 6 - Calculate New Plus Replaced Pollution Generating Surface	2-22
2.7. Step 7 - Determine Which Minimum Requirements Apply	2-22
CHAPTER 3 - Minimum Requirements for All Projects	3-1
3.1. Maintaining Natural Drainage Patterns	3-1
3.2. Discharge Point	3-1
3.2.1. Approved Point of Discharge	3-1
3.2.2. Conveyance Systems to Point of Discharge	3-2
3.3. Flood-Prone Areas.....	3-3
3.4. Construction Site Stormwater Pollution Prevention Control	3-3
3.5. Protect Wetlands.....	3-4
3.6. Protect Streams and Creeks	3-5
3.7. Protect Shorelines.....	3-5
3.8. Ensure Sufficient Capacity	3-5
3.9. Install Source Control BMPs.....	3-5
3.10. Do Not Obstruct Watercourses	3-6
3.11. Comply with Side Sewer Code.....	3-6
3.12. Extension of Public Drainage System.....	3-7

3.12.1. Projects Not Constructed in the Right-of-Way	3-7
3.12.2. Projects Constructed in the Right-of-Way.....	3-8
3.13. Public Drainage System Requirements.....	3-8
3.14. Maintenance and Inspection.....	3-9
CHAPTER 4 - Minimum Requirements Based on Project Type.....	4-1
4.1. Single-Family Residential Projects	4-3
4.2. Trail and Sidewalk Projects	4-4
4.3. Roadway Projects	4-5
4.3.1. Soil Amendment	4-5
4.3.2. On-site Stormwater Management.....	4-5
4.3.3. Flow Control	4-5
4.3.4. Water Quality Treatment	4-13
4.4. Parcel-Based Projects	4-15
4.4.1. Soil Amendment	4-15
4.4.2. On-site Stormwater Management.....	4-15
4.4.3. Flow Control	4-19
4.4.4. Water Quality Treatment	4-23
4.5. Reduced Requirements for Certain Land-Disturbing Activities	4-24
4.5.1. Utility Projects	4-24
4.5.2. Pavement Maintenance Projects.....	4-24
4.5.3. Remediation Projects.....	4-25
4.5.4. Retrofit Projects.....	4-25
4.6. WSDOT Projects	4-26
4.7. Special Circumstances.....	4-27
CHAPTER 5 - Minimum Requirement Standards	5-1
5.1. Soil Amendment	5-1
5.2. On-site Stormwater Management.....	5-1
5.2.1. On-site Performance Standard	5-3
5.2.2. On-site Lists	5-3
5.3. Flow Control	5-9
5.3.1. Wetland Protection Standards	5-10
5.3.2. Pre-Developed Forested Standard	5-11
5.3.3. Pre-Developed Pasture Standard	5-12
5.3.4. Existing Condition Standard	5-12
5.3.5. Peak Control Standard.....	5-12
5.4. Water Quality Treatment	5-12
5.4.1. General Water Quality Treatment Requirements	5-14
5.4.2. Water Quality Treatment Standards	5-15
CHAPTER 6 - Alternative Compliance	6-1
CHAPTER 7 - Site Assessment and Planning.....	7-1
7.1. Identifying Key Project Components	7-1
7.2. Project Boundaries and Structures	7-1
7.3. Soil Condition Assessment	7-2

7.4. Environmentally Critical Areas (ECAs) 7-2

7.5. Dewatering 7-2

7.6. Topography 7-3

7.7. Site Assessment 7-3

7.8. Landscaping Principles 7-4

 7.8.1. Principle 1: Minimize Bare Soil Areas 7-5

 7.8.2. Principle 2: Reduce Water Demand 7-5

 7.8.3. Principle 3: Reduce Turf Area and Manage Remaining Turf to
 Reduce Pollutant Impact 7-6

 7.8.4. Principle 4: Select Plants with Sustainability in Mind 7-6

 7.8.5. Principle 5: Reduce or Eliminate Fertilizer, Pesticide, Herbicide,
 and Fungicide Use and Where, Required, Manage Application
 Wisely 7-7

7.9. Site Design Considerations 7-8

CHAPTER 8 - Drainage Control Review and Application Requirements 8-1

 8.1. Preliminary Drainage Review 8-1

 8.2. Standard Drainage Review 8-2

 8.3. Comprehensive Drainage Review 8-6

 8.4. Additional Documentation 8-7

Tables

Table A for 22.805.070.	On-site List for Single-Family Residential Projects.	5-5
Table B for 22.805.070.	On-site List for Trail and Sidewalk Projects.	5-6
Table C for 22.805.070.	On-site List for Parcel-Based Projects.	5-7
Table D for 22.805.070.	On-site List for Roadway Projects.	5-8

Figures

Figure 2.1.	Single-Family Residential Project Site Definition.	2-5
Figure 2.2.	Sidewalk-only Project Site Definition.	2-6
Figure 2.3.	Trail Project Definition.	2-7
Figure 2.4.	Roadway Project Site Definition.	2-9
Figure 2.5.	Parcel-Based Project Site Definition.	2-11
Figure 2.6.	North End Creek Basins.	2-15
Figure 2.7.	South End Creek Basins.	2-16
Figure 2.8.	Public Combined Sewer Basins.	2-17
Figure 2.9.	North End Designated Receiving Water Drainage Areas.	2-18
Figure 2.10.	South End Designated Receiving Water Drainage Areas.	2-19
Figure 2.11.	Capacity Constrained Systems.	2-20
Figure 4.1A.	Project Minimum Requirements for Roadway Projects.	4-7
Figure 4.1B.	Project Minimum Requirements for Roadway Projects (continued).	4-8
Figure 4.1C.	Project Minimum Requirements for Roadway Projects (continued).	4-9
Figure 4.2A.	Project Minimum Requirements for Parcel-Based Projects.	4-16
Figure 4.2B.	Project Minimum Requirements for Parcel-Based Projects (continued).	4-17
Figure 4.2C.	Project Minimum Requirements for Parcel-Based Projects (continued).	4-18

ACKNOWLEDGEMENTS

The 2021 Seattle Stormwater Manual is dedicated to Liz Anderson. Liz contributed her knowledge and expertise to the City of Seattle for more than 30 years as a Professional Engineer. Her depth and breadth of knowledge of Seattle’s drainage and wastewater system; her design experience; and her dedication, mentorship, and “whip-smart” can-do attitude has made Seattle a better place and the Stormwater Code and Manual more effective at managing the impacts of stormwater on people, property, and the environment. We miss Liz’s expertise, friendship, and perseverance and wish her all the best in her well-deserved retirement.

The City of Seattle gratefully acknowledges the valuable time, comments, and expertise provided by the people listed below who contributed to the 2021 Seattle Stormwater Manual.

City of Seattle Core Team

Name	Affiliation	Role
Sherell Ehlers	SPU	Code Update Lead, Program Manager
Jonathan Brown	SPU	Project Manager
Ingrid Wertz	SPU	Project Manager
Shanti Colwell	SPU	Core Team
Kevin Burrell	SPU	Core Team
Lan Chau	SPU	Core Team
Liz Anderson	SPU	Core Team
Karen Iwasaki	SPU	Core Team
Mary Weber	SPU	Volume 3 Co-Lead, Core Team
Matthew Bateman	SDCI	Volume 1 Lead, Core Team
Ede Courtenay	SDCI	Core Team
Jean Lee	Parks	Core Team
Scott Stevens	Parks	Core Team
Michael Cawrse	SDOT	Core Team
Nick Shrope	SDOT	Core Team
Theresa Wagner	Law	Core Team
Cris Horbelt	SPU	Volume 2 Lead
Kevin Buckley	SPU	Volume 4 Lead
Michael Jeffers	SPU	Volume 4 Team
Erik Lust	SPU	Volume 4 Team
Valerie Monsey	SDCI	Volume 4 Team
Dean Huber	SPU	Technical Support
Melissa Ivancevich	SPU	Technical Support
Brent Robinson	SPU	Technical Support
Miles Mayhew	SPU	Technical Support
Tai Ovbiebo	SPU	Modeling Support
Justin Twenter	SPU	Modeling Support

Name	Affiliation	Role
Michelle Lange	SPU	Technical Support
Edward Lombana	SPU	Technical Support
Aziz Alfi	SPU	Technical Support
Art Richardson	SDCI	Technical Support
Roger Moore	SDCI	Technical Support
Eric Dripps	SDCI	Technical Support
Rob McIntosh	SDCI	Technical Support
Moon Callison	SDCI	Communication Support
Wendy Shark	SDCI	Communication Support
Jeff Weber	Law	Advisory Support
Andrew Eberly	Law	Advisory Support
William Foster	Law	Advisory Support

Consultant Team

Name	Affiliation	Role
Rebecca Dugopolski	Herrera Environmental Consultants	Project Manager
Alice Lancaster	Herrera Environmental Consultants	Senior Technical Advisor
Neil Schaner	Herrera Environmental Consultants	Modeling Lead
Katie Wingrove	Herrera Environmental Consultants	Technical Support
Kate Forester	Herrera Environmental Consultants	Technical Support
Meghan Mullen	Herrera Environmental Consultants	Modeling Support
John Lenth	Herrera Environmental Consultants	Senior Technical Advisor
Craig Doberstein	CPD Solutions	Senior Technical Advisor
Gretchen Muller	Cascadia Consulting Group	Public Outreach Lead
Claire Gibson	Clarity Engineering	Technical Support
Richard Martin	Richard Martin Groundwater	Technical Support
Kristen Matsumura	Lotus Water	Implementation Tools Support
Robin Kirschbaum	RKI	Technical Support
Bruce Barker	MGS Engineering Consultants	Modeling Support
Christine Sophos	CMS Writing and Editing Services	Technical Editor
Lisa Skutecki	Brown and Caldwell	National Advisory Team
Chad Praul	Environmental Incentives	National Advisory Team
Franco Montalto	eDesign Dynamics	National Advisory Team
Eric Zickler	Lotus Water	National Advisory Team

Ecology Reviewers

Name	Affiliation
Colleen Griffith	Department of Ecology
Doug Howie	Department of Ecology

External Stakeholders who participated in the October 2019 Workshop

Name	Affiliation
Kimberly McNabb, Mary Koutrelakos	Blueline
Bailey Cook, Ken Wiersema	Coughlin Porter Lundeen
Tim Gabelein, Cheyenne Thompson	Davido Consulting Group
Brian Ward	HDR
David Tran	Helsell Fetterman
Kory Swabb	Jacobs
Jenifer Clapham, Puja Shaw, Scott Meurn	KPFF
Lolly Kunkler	MIGISvR
David Sand	MKA
John J Weed, Christian Nichols, Toby Coenen	PACE
John Erickson	WSP

CHAPTER 1 – INTRODUCTION

1.1. Purpose of This Manual (Volumes 1 through 5 and Appendices)

In addition to meeting the specific stormwater needs of the City of Seattle (City), the Stormwater Code meets certain requirements that apply to the City from the ~~2019-2024~~~~2013-2018~~ Phase I National Pollutant Discharge Elimination System and State Waste Discharge General Permit for Discharges from Large and Medium Municipal Separate Storm Sewer Systems, ~~modified~~ effective ~~August 1, 2019~~~~January 16, 2015~~ (referred to as the Phase I NPDES Municipal Stormwater Permit). Coverage under the general permit is issued to the City by the Washington State Department of Ecology (Ecology) pursuant to the federal Clean Water Act and state law. One of the conditions of this permit requires the City to adopt and make effective a local program to prevent and control the impacts of stormwater runoff from new development, redevelopment and construction activities. This is accomplished, in large measure, through the Seattle Stormwater Code and its associated Directors' Rule (this Manual) which Ecology has determined to meet the requirements contained in the Phase I NPDES Municipal Stormwater Permit, with reference to the *Stormwater Management Manual for Western Washington* (Ecology ~~2019~~~~2014~~).

The City's Stormwater Code is contained in the Seattle Municipal Code (SMC), Chapters 22.800 through 22.808. The Stormwater Code contains regulatory requirements that provide for and promote the health, safety, and welfare of the general public. The provisions of the Stormwater Code are designed to accomplish the following:

1. To protect, to the greatest extent practicable, life, property and the environment from loss, injury, and damage by pollution, erosion, flooding, landslides, strong ground motion, soil liquefaction, accelerated soil creep, settlement and subsidence, and other potential hazards, whether from natural causes or from human activity.
2. To protect the public interest in drainage and related functions of drainage basins, watercourses, and shoreline areas.
3. To protect receiving waters from pollution, mechanical damage, excessive flows and other conditions that will increase the rate of downcutting, stream bank erosion, and/or the degree of turbidity, siltation, and other forms of pollution, or which will reduce their low flows or low levels to levels which degrade the environment, reduce recharging of groundwater, or endanger aquatic and benthic life within these receiving waters and receiving waters of the state.
4. To meet the requirements of state and federal law and the City's municipal stormwater NPDES permit.
5. To protect the functions and values of environmentally critical areas as required under the state's Growth Management Act and Shoreline Management Act.
6. To protect the public drainage system from loss, injury, and damage by pollution, erosion, flooding, landslides, strong ground motion, soil liquefaction, accelerated soil

creep, settlement and subsidence, and other potential hazards, whether from natural causes or from human activity.

7. To fulfill the responsibilities of the City as trustee of the environment for future generations.

To support implementation of the Stormwater Code, the Director of Seattle Public Utilities (SPU) and the Director of the Seattle Department of Construction and Inspection (SDCI) promulgate rules that provide specific technical requirements, criteria, guidelines, and additional information. This Directors' Rule consists of a five-volume City Stormwater Manual and nine appendices.

~~At the time of publication of this rule, legislation was transmitted by the Mayor to the City Council that would abolish the Department of Planning and Development (DPD) and establish the SDCI. The purpose of SDCI is to administer City ordinances that regulate building construction, the use of land, and housing, and is anticipated to be effective January 4, 2016.~~

1.2. How to Use this Manual (Volumes 1 through 5 and Appendices)

The City's Stormwater Manual includes the following five volumes:

- *Volume 1: Project Minimum Requirements* provides information regarding how to apply the minimum requirements contained in the Stormwater Code. It also provides site assessment and planning steps and requirements for drainage control review submittals.
- *Volume 2: Construction Stormwater Control* contains temporary erosion and sediment control technical requirements, which are required to prevent contaminants from leaving the project site during construction.
- *Volume 3: Project Stormwater Control* presents approved methods, criteria, and details for analysis and design of on-site stormwater management, flow control, and water quality treatment best management practices (BMPs).
- *Volume 4: Source Control* provides information to individuals, businesses, and public agencies in Seattle to implement BMPs for controlling pollutants at their source and preventing contamination of stormwater runoff.
- *Volume 5: Enforcement* provides standards, guidelines, and requirements for enforcing the Stormwater Code.

The City's Stormwater Manual includes the following nine appendices:

- *Appendix A: Definitions* provides terminology [from the Stormwater Code](#) for all five volumes of the Stormwater Manual.
- *Appendix B: ~~Additional Submittal Requirements~~Background Information on Chemical Treatment* provides supplemental information for Volume [1 \(Project Minimum Requirements\)](#) ~~2 (Construction Stormwater Control)~~ related to submittal requirements.
- *Appendix C: On-site Stormwater Management Infeasibility Criteria* provides a list of criteria to be evaluated for on-site stormwater management.

- *Appendix D: Subsurface Investigation and Infiltration Testing for Infiltration BMPs* describes subsurface report requirements, geotechnical explorations, four infiltration testing methods (Simple Test, Small Pilot Infiltration Test (PIT), Large PIT, and Deep Infiltration Test), infiltration rate correction factors, groundwater monitoring, and groundwater mounding analysis.
- *Appendix E: Additional Design Requirements and Plant Lists* includes additional design requirements for flow control structures, flow splitters, flow spreaders, level spreaders, pipe slope drains, outlet protection, facility liners, and geotextiles. *Appendix E* also includes plant lists for biofiltration swales, sand filters, and wet ponds.
- *Appendix F: Hydrologic Analysis and Design* includes descriptions of acceptable methods for estimating the quantity and hydrologic characteristics of stormwater runoff, and the assumptions and data requirements of these methods.
- *Appendix G: Stormwater Control Operations and Maintenance Requirements* contains maintenance requirements for typical stormwater BMPs and components.
- *Appendix H: Financial Feasibility Documentation for Vegetated Roofs and Rainwater Harvesting* provides additional guidance on the required documentation to prove financial infeasibility of vegetated roofs or rainwater harvesting.
- *Appendix I: [Landscape Management Plans and Integrated Pest Management Plans](#)* provides supplemental information for [Volume 1 \(Project Minimum Requirements\)](#) and Volume 4 (Source Control).

1.3. Purpose of Volume 1

Volume 1 – Project Minimum Requirements describes and contains minimum requirements for all types of land development and redevelopment. It also provides site assessment and planning steps and drainage control review requirements.

1.4. How to Use this Volume

- *Chapter 1* outlines the purpose and content of the Stormwater Manual and this volume.
- *Chapter 2* outlines steps to determine a project’s minimum requirements.
- *Chapter 3* describes the minimum requirements for all projects.
- *Chapter 4* describes the minimum requirements for specific project types.
- *Chapter 5* describes the minimum standards for on-site stormwater management, flow control, and water quality treatment.
- *Chapter 6* describes the options for alternative compliance.
- *Chapter 7* summarizes site assessment and planning steps and key project components.
- *Chapter 8* summarizes the [preliminary](#), [standard](#), and comprehensive drainage review minimum submittal requirements.

CHAPTER 2 – DETERMINING MINIMUM REQUIREMENTS

~~Per the Stormwater Code (SMC, Section 22.801.170), “project” means “the addition or replacement of hard surface or the undertaking of land-disturbing activity on a site.” A hard surface is defined as an impervious surface, a permeable pavement, or a vegetated roof.~~

There are seven basic steps used to determine which minimum requirements for on-site stormwater management, flow control, and water quality treatment apply to a project:

- Step 1 – Define the boundaries of the project site
- Step 2 – Identify the type of project
- Step 3 – Identify the receiving water and downstream conveyance
- Step 4 – Perform site assessment and planning
- Step 5 – Calculate new plus replaced hard surface and native vegetation conversion
- Step 6 – Calculate new plus replaced pollution generating surface
- Step 7 – Determine which minimum requirements apply

Note that these seven steps are focused on determining applicable minimum requirements for on-site stormwater management, flow control, and water quality treatment specifically. These seven steps are described in further detail below.

In addition to determining the applicable minimum requirements, all projects shall also review and comply with all other Stormwater Code requirements, in particular the Minimum Requirements for All Discharges and All Real Property (SMC, Section 22.803) and the Minimum Requirements for All Projects (SMC, Section 22.805).

~~Excerpts from the Stormwater Code (in *italics*) are presented below in the first column in the code reference box in most sections. The second column in the code reference box provides applicable references.~~

2.1. Step 1 – Define the Boundaries of the Project Site

The boundaries of the project site shall ~~include all development activities as defined by SMC, Section 22.801.050. contain the discharge point, all land-disturbing activities, and all new and replaced hard surfaces.~~ The boundary of the public right-of-way typically forms the boundary between project types if more than one project type exists. The project site may also include contiguous areas that are subject to the addition or replacement of hard surface or the undertaking of land-disturbing activity. ~~In the case of a subdivision or short plat, the boundary of the project site is the full area included in the subdivision or short plat.~~

2.1.1. Definitions

Stormwater Code Language	References
<p>SMC, Section 22.801.050 – <u>“Development” means the following activities:</u></p> <ol style="list-style-type: none"> 1. <u>Class IV-general forest practices that are conversions from timberland to other uses;</u> 2. <u>land disturbing activity;</u> 3. <u>the addition or replacement of hard surfaces;</u> 4. <u>expansion of a building footprint or addition or replacement of a structure;</u> 5. <u>structural development, including construction, installation, or expansion of a building or other structure;</u> 6. <u>seeking approval of a building permit other construction permit, grading permit, or master use permit that involves any of the foregoing activities; and</u> 7. <u>seeking approval of subdivision, short plat, unit lot subdivision, or binding site plans, as defined and applied in chapter 58.17 RCW, and other master use permit.</u> <p><u>Development is a type of project.</u></p>	<ul style="list-style-type: none"> • <u>None provided</u>
<p>SMC, Section 22.801.090 – <u>“Hard surface” means an impervious surface, a permeable pavement, or a vegetated roof.</u></p>	<ul style="list-style-type: none"> • <u>None provided</u>
<p>SMC, Section 22.801.170 – <u>“Project” means any proposed action to alter or develop a site. Development is a type of project.</u></p>	<ul style="list-style-type: none"> • <u>None provided</u>
<p>SMC, Section 22.801.170 – <u>“Project site” means that portion of a property, properties, or rights-of-way, subject to land-disturbing activities, new hard surfaces or replaced hard surfaces.</u></p>	<ul style="list-style-type: none"> • <u>None provided</u>

Defining project boundaries will help identify the project type(s) in Step 2.

2.1.2. Closely Related Projects

Stormwater Code Language	References
<p>SMC, Section 22.805.010.B – <u>Closely related projects shall be considered as one project for purposes of applying the Stormwater Code, including but not limited to determining whether the thresholds for applicability of particular Stormwater Code minimum requirements are met.</u></p>	<ul style="list-style-type: none"> • <u>None provided</u>

The Director shall determine whether two or more projects are closely related by applying the following criteria:

1. Two or more projects under review at the same time are treated as a single project if any of the following are true:
 - a. Any feature physically spans the property lines between lots, such as shared structures, shared driveways, shared pedestrian access (including easements to rights-of-way), shared drainage and utility designs, foundation footings, or retaining walls
 - b. A shared driveway accesses a parking area(s) for more than one project, regardless of whether the parking is required

- c. Parking for a project, including maneuvering, aisle requirements, or other parking-related easements, whether the parking is required or not, is proposed to be provided (or partially provided) on the site of another project, even if the sites do not abut each other
 - d. Proposed structures are joined, or share a common wall
 - e. Proposed projects share required open space and/or amenity area
 - f. The design of two or more projects are dependent on grading, construction of retaining walls, and/or foundation design across the lot lines
 - g. One site is required to permanently access, construct and maintain the structures and/or development features on an abutting or adjacent site
 - h. Other features that create interdependence between projects.
- 2. The following features are not to be taken into consideration in determining whether two or more projects are to be evaluated as a single project:
 - a. Physical connections to a common public right-of-way (such as a street, sidewalk, or alley) or to a public drain or public utility lines in the right-of-way
 - b. Common developer, property owner, or marketing/sales scheme for the development proposals
 - c. Exclusive easements for vehicular or pedestrian access (including easements to rights-of-way) designed to restrict shared access between projects
 - d. Similar or identical design
 - e. Simultaneous construction on abutting lots, even by the same crew
 - f. A common architectural or landscaping design
 - g. Utility-only easements crossing one development site to serve abutting or adjacent lots
 - h. Shared temporary construction access
 - i. Other features that make projects independent of one another
- 3. If separate applications for development under review at the same time are determined to be one project under this rule, then the total combined development proposed in the applications will be considered when determining Stormwater Code requirements. Projects that are submitted for review are considered “under review” until the applicable construction permits for the project are issued or the permit application is withdrawn by the applicant.

2.2. Step 2 – Identify the Type of Project

For the purposes of determining applicable minimum requirements, there are eight general classifications of projects:

- 1. Single-family residential (SFR) project
- 2. Sidewalk project

3. [Trail project](#)
4. [Roadway project](#)
5. [Parcel-based project](#)
6. [Certain land-disturbing activities](#)
7. [Washington State Department of Transportation \(WSDOT\) project](#)
8. [Special circumstances project](#)

Each project type is described in the following subsections ([Section 2.2.1](#) through [2.2.8](#)).

[2.2.1. Single-Family Residential Project](#)

A single-family residential (SFR) project (Figure 2.1) is defined in ~~the Stormwater Code (SMC, Section 22.801.200)~~, as:

~~A project that constructs one single-family dwelling unit located in land classified as being Single-family Residential 9,600 (SF 9600), Single-family Residential 7,200 (SF 7200), or Single-family Residential 5,000 (SF 5000) pursuant to SMC, Section 23.30.010,~~

~~The total new plus replaced hard surface is less than 10,000 square feet, and~~

~~The total new plus replaced pollution-generating hard surface (PGHS) is less than 5,000 square feet.~~

Stormwater Code Language	References
SMC, Section 22.801.200 – “Single-family residential project” means a project that constructs one Single-family Dwelling Unit as defined in subsection 23.84A.032 and any associated accessory dwelling unit located in land classified as being Single-family Residential 9,600 (SF 9600), Single-family Residential 7,200 (SF 7200), or Single-family Residential 5,000 (SF 5000) pursuant to Section 23.30.010, and the total new plus replaced hard surface is less than 5,000 square feet.	<ul style="list-style-type: none"> • Figure 2.1

Note: ~~that P~~projects with ~~10,000-5,000~~ square feet or more of new plus replaced hard surface, ~~or more than 5,000 square feet of PGHS,~~ are considered parcel-based projects.

[Also, single-family residential projects shall comply with any associated master use permit requirements \(e.g., requirements for subdivisions, short plats, unit lot subdivisions\), as applicable. For example, if a subdivision required Flow Control Standards, all Single-family projects must meet the requirements of the same Flow Control Standard. Depending on the design in the approved preliminary drainage control plan, this may be achieved by a shared facility that may be constructed prior to the construction of the improvements for the Single-family residential project or by individual facilities that may be required to be constructed with the Single-family residential project. All short plats and subdivisions are considered parcel-based projects \(Section 2.2.5\), regardless of the land use zoning.](#)

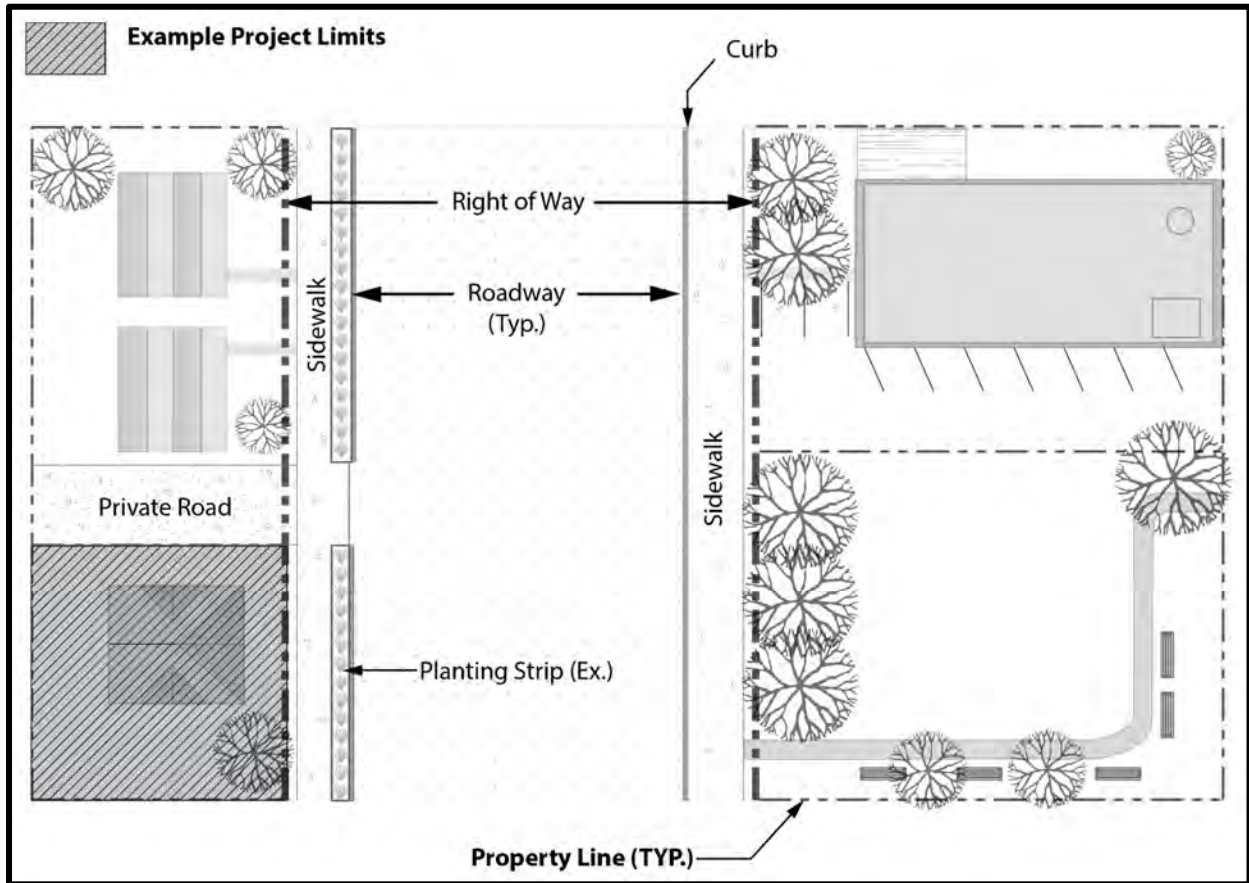

Figure 2.1. Single-Family Residential Project Site Definition.

2.2.2. Sidewalk Project

A sidewalk project (Figure 2.2) is defined ~~in as a project for the creation of a new sidewalk or replacement of an existing sidewalk, including any associated planting strip, apron, curb ramp, curb, or gutter, and necessary roadway grading and repair. If the total new plus replaced hard surface in the roadway exceeds 10,000 square feet, the entire project is a roadway project (SMC, Section 22.801.200).~~

Stormwater Code Language	References
<p><i>SMC, Section 22.801.200 – “Sidewalk project” means a project for the creation of a new sidewalk or replacement of an existing sidewalk, including any associated planting strip, apron, curb ramp, curb, or gutter, and necessary roadway grading and repair. If the total new plus replaced hard surface in the roadway exceeds 10,000 square feet, the entire project is a roadway project.</i></p>	<ul style="list-style-type: none"> • Figure 2.2

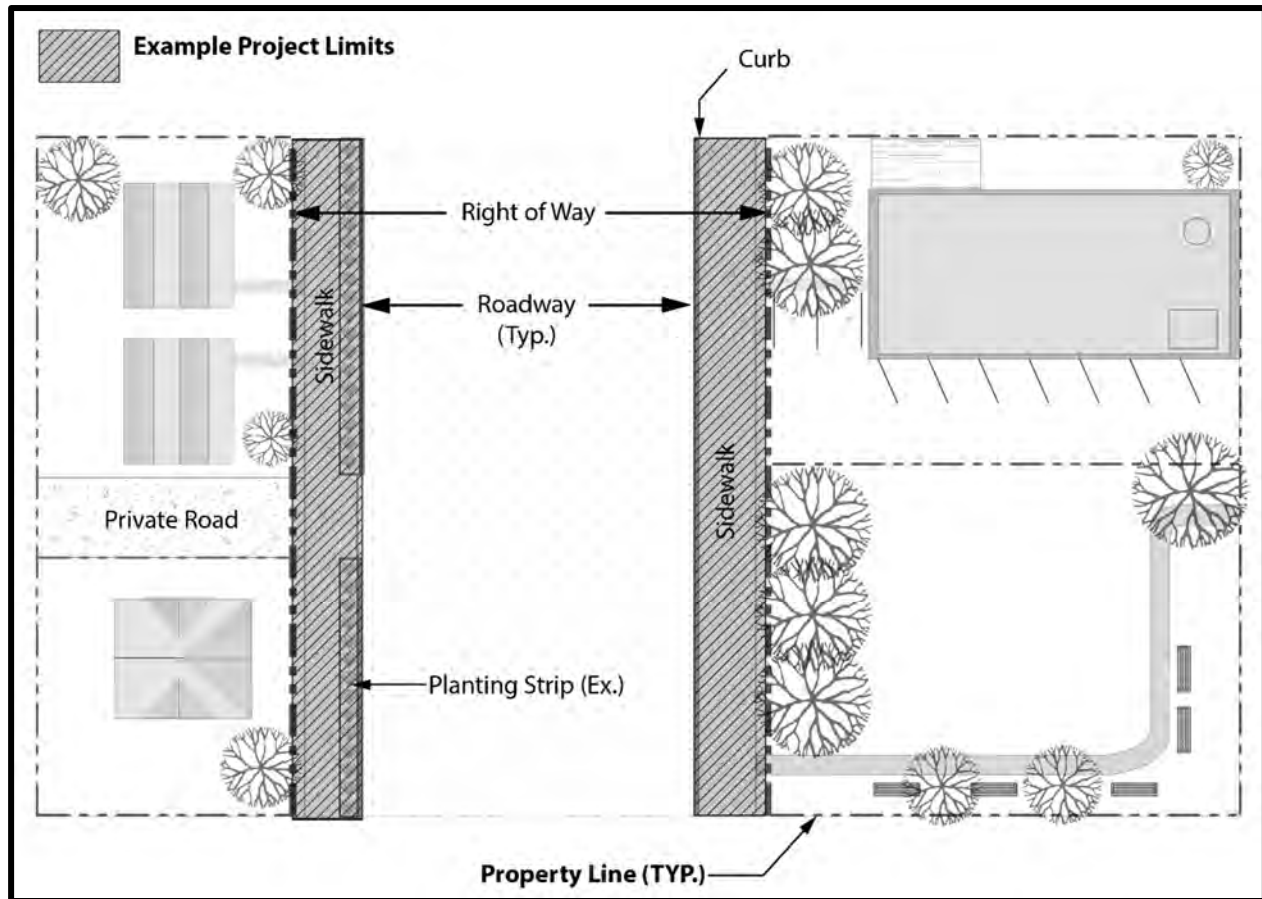

Figure 2.2. Sidewalk-only Project Site Definition.

2.2.3. Trail Project

A trail project (Figure 2.3) is defined in as a project for the creation of a new trail or replacement of an existing trail, which does not contain PGHS (SMC, Section 22.801.210).

Stormwater Code Language	References
<p>SMC, Section 22.801.210 – <u>“Trail project” means a project for the creation of a new trail or replacement of an existing trail, which does not contain PGHS.</u></p>	<ul style="list-style-type: none"> • Figure 2.3

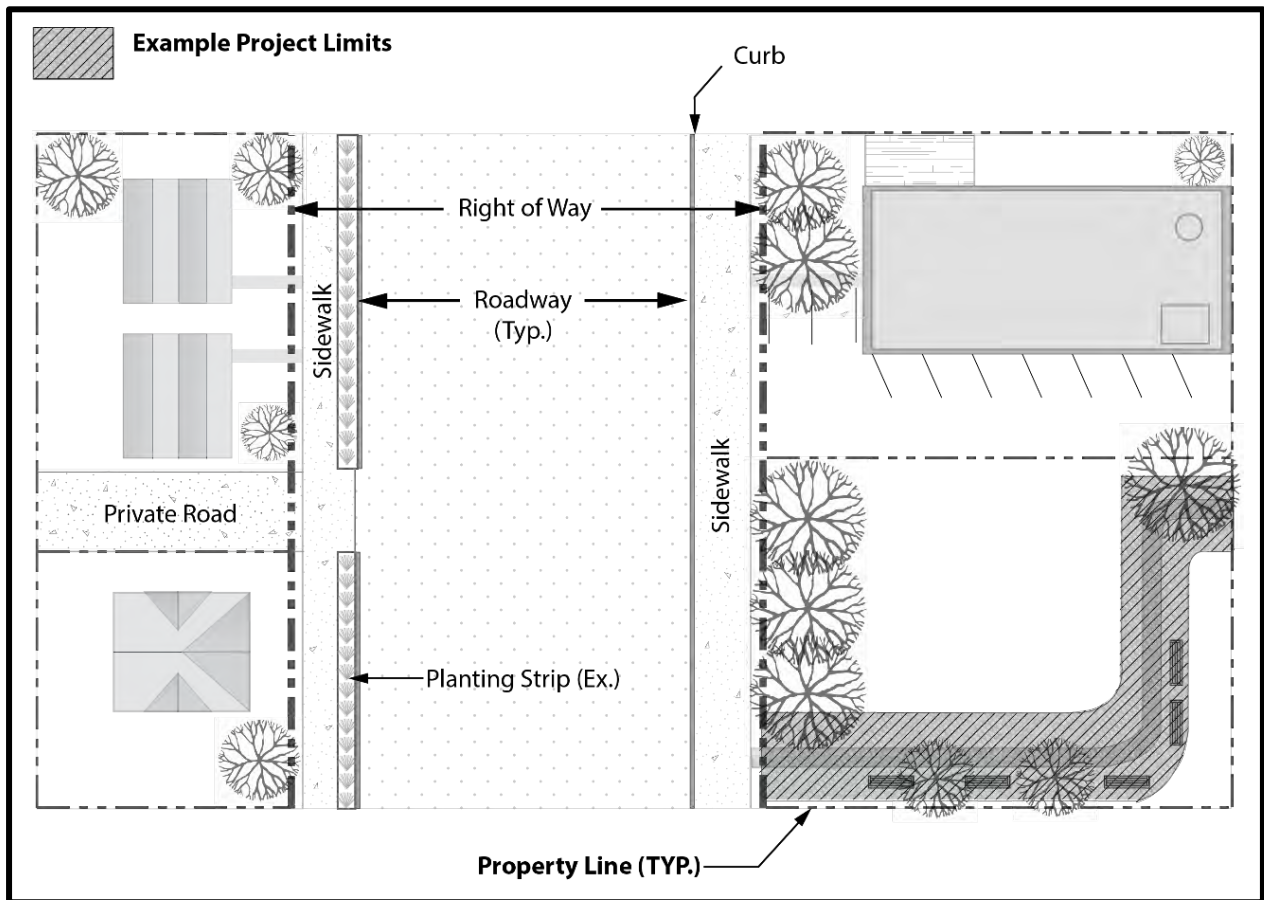

Figure 2.3. Trail Project Definition.

2.2.4. Roadway Project

A roadway project (Figure 2.4) is defined ~~in as a project located in the public right-of-way that involves the creation of a new or replacement of an existing roadway or alley. The boundary of the public right-of-way shall form the boundary between the parcel and roadway portions of a project (SMC, Section 22.801.190). A roadway project can also include other improvements located in the public right-of-way.~~

<u>Stormwater Code Language</u>	<u>References</u>
<u>SMC, Section 22.801.190 – “Roadway project” means a project located in the public right-of-way that involves the creation of a new or replacement of an existing roadway or alley. The boundary of the public right-of-way shall form the boundary between the parcel and roadway portions of a project.</u>	<ul style="list-style-type: none"> • <u>Figure 2.4</u>

Typically, the boundary of the public right-of-way forms the boundary between the parcel and roadway portions of a project, but special circumstances may exist (Refer to Section 4.7).

Projects that do not meet the definition of a roadway project (i.e., projects that include any development in addition to the creation of a new or replacement of an existing roadway or alley), are parcel-based projects. As an example, portions of projects that include building development and associated hard surfaces (e.g., parking lot) located in the public right-of-way are considered parcel-based projects (refer to Section 4.4 for requirements).

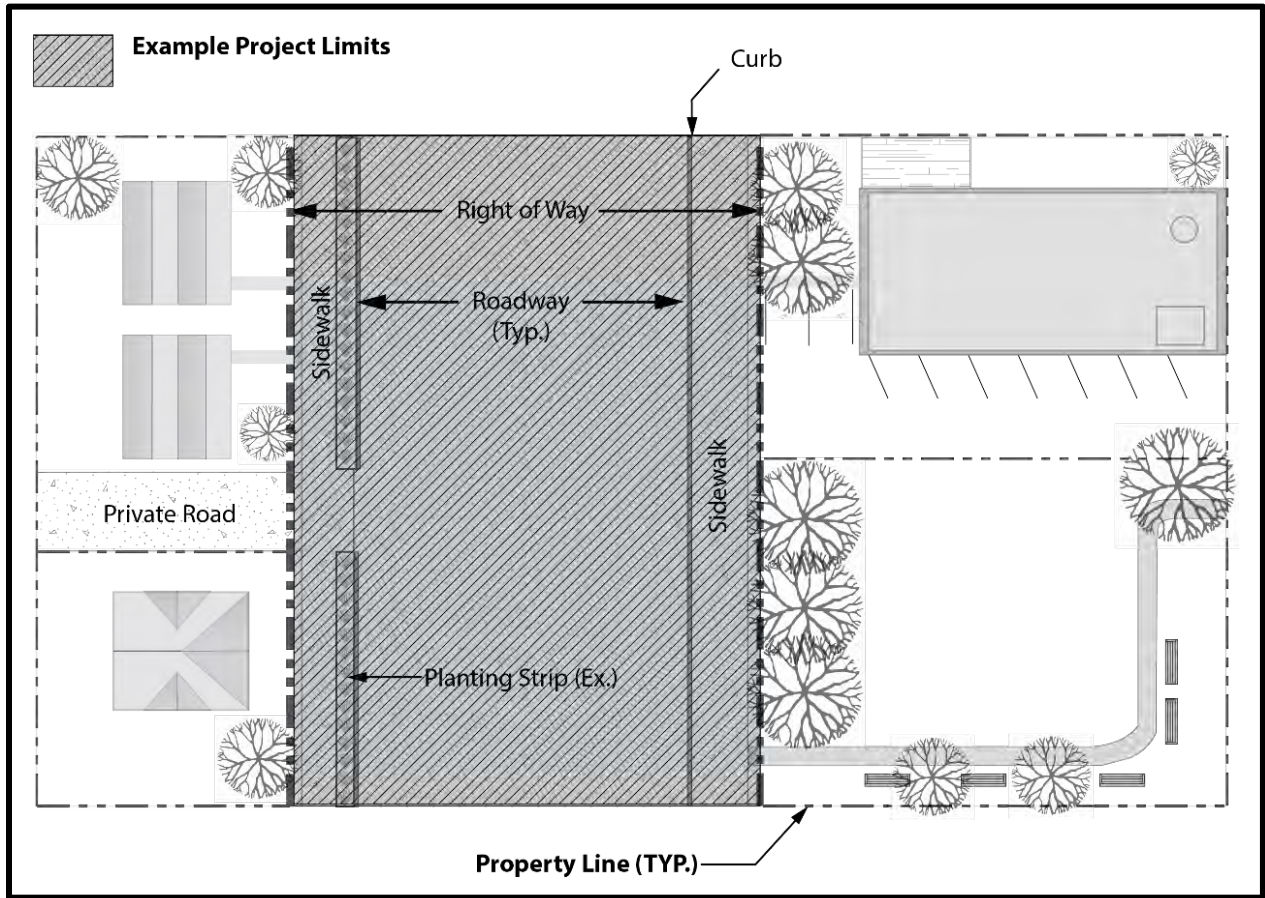

Figure 2.4. Roadway Project Site Definition.

2.2.5. Parcel-Based Project

A parcel-based project (Figure 2.5) is defined in means any project that is not a single family residential project, roadway project, sidewalk project, or trail project. The boundary of the public right-of-way shall form the boundary between the parcel and roadway portions of a project (SMC, Section 22.801.170).

<u>Stormwater Code Language</u>	<u>References</u>
<u>SMC, Section 22.801.170 – “Parcel-based project” means any project that is not a single-family residential project, roadway project, sidewalk project, or trail project. The boundary of the public right-of-way shall form the boundary between the parcel and roadway portions of a project.</u>	<ul style="list-style-type: none"> • <u>Figure 2.5</u>

Examples of parcel-based projects include, but are not limited to, commercial developments and, multi-family multifamily developments, apartments, carriage houses, cottage housing development, rowhouse developments, townhouse development, institutions, industrial buildings and sites, parking lots, parks and playgrounds, commercial use development, public facilities, live-work units, manufacturing facilities, storage facilities, transportation facilities, utility use facilities, subdivisions, and short plats.

In addition, the following specific pollution-generating activities or projects are considered parcel-based projects and require drainage review. Specifically, source control BMPs shall be implemented as specified in Volume 4, to the extent necessary to prevent prohibited discharges and to prevent contaminants from coming in contact with drainage water or being discharged to the drainage system, public combined sewer, or directly into receiving waters.

<u>Stormwater Code Language</u>	<u>References</u>
<u>SMC, Section 22.807.020.A.2.j – Applications for approvals for activities or projects for:</u> <ol style="list-style-type: none"> <u>1. Fueling at dedicated stations, for new or substantially altered fueling stations.</u> <u>2. In-water and over-water fueling.</u> <u>3. Maintenance and repair of vehicles and equipment.</u> <u>4. Concrete and asphalt mixing and production.</u> <u>5. Recycling, wrecking yard, and scrap yard operations.</u> <u>6. Storage of liquids in aboveground tanks.</u> <u>7. Other projects that the Director determines pose a hazard to public health, safety, or welfare; endanger any property; adversely affect the safety and operation of City right-of-way, utilities, or other property owned or maintained by the City; or adversely affect the functions and values of an environmentally critical area or buffer.</u> 	<ul style="list-style-type: none"> • <u>None provided</u>

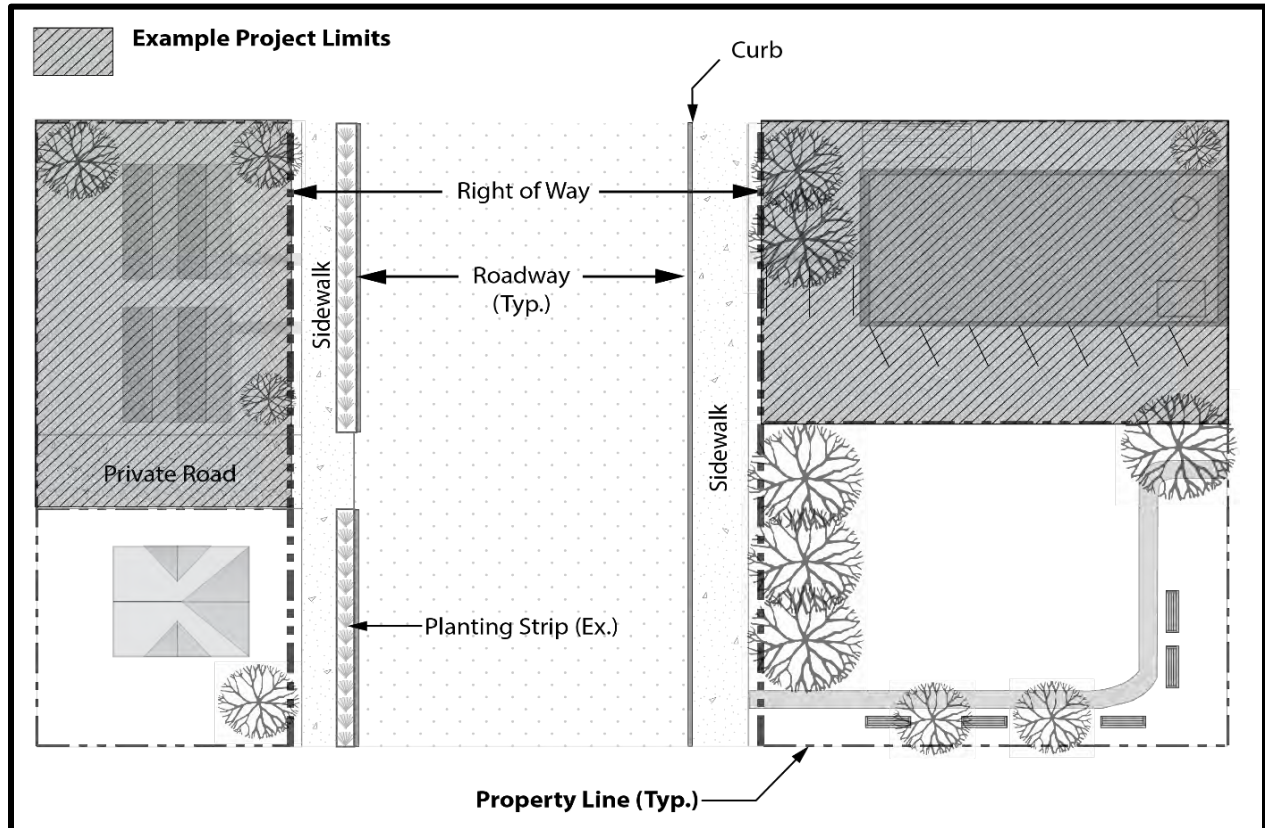

Figure 2.5. Parcel-Based Project Site Definition.

2.2.6. *Certain Land-Disturbing Activities*

Certain land-disturbing activities, including some utility and pavement maintenance projects, are not required to comply with some of the minimum requirements (refer to Section 4.5). For the purposes of this Manual, a utility project (land disturbing activity not required to comply with requirements as stated in SMC, Section 22.800.040.A.2 unless otherwise noted below) includes maintenance, repair, or installation of underground or overhead utility facilities, such as, but not limited to, pipes, conduits, and vaults, and that includes replacing the ground surface with in-kind material or materials with similar runoff characteristics.

Installation of a new or replacement of an existing public drainage system, public combined sewer, or public sanitary sewer in the public right-of-way shall comply with Section 22.805.060 (Minimum Requirements for Roadway Projects) when these activities are implemented as publicly bid capital improvement projects funded by Seattle Public Utilities.

For the purposes of this Manual, a pavement maintenance project (land disturbing activity not required to comply with requirements as stated in SMC, Section 22.800.040.A.2) is limited to the following maintenance activities:

- Pothole and square cut patching
- Overlaying existing asphalt, concrete, or brick pavement with asphalt or concrete without expanding the area of coverage

- ~~Shoulder grading~~
- ~~Reshaping or regrading drainage ditches~~
- ~~Crack sealing~~
- ~~Vegetation maintenance~~

2.2.7. WSDOT Project

For the purposes of this Manual, a ~~Washington State Department of Transportation (WSDOT)~~ project (which shall manage stormwater as stated in SMC, Section 22.800.040.A.6) includes WSDOT roadway projects within state rights-of-way under WSDOT control within the jurisdiction of the City.

In addition to the other provisions in Section 22.800.040.A.6, WSDOT projects shall comply with Stormwater Code requirements when discharging to a public drainage system or combined sewer system as prescribed in Section 22.800.040.A.6.c (refer to Section 4.6).

2.2.8. Special Circumstances Projects

Special circumstances projects do not closely fit a defined project type or have complicating elements (e.g., discharge to multiple drainage basins with differing requirements) and require a case-by-case review (refer to Section 4.74-8).

2.3. Step 3 – Identify the Receiving Water and Downstream Conveyance

For minimum requirement purposes, runoff leaving the project site is classified based on the type of receiving water and system into which the project site discharges. The project proponent shall ~~determine-identify~~ the receiving water or point of discharge for the stormwater runoff from the project site (e.g., wetland, lake, creek, salt water, or combined sewer) for review and approval or disapproval by the Director. Refer to Section 3.2 and Section 3.12.

The minimum requirements vary considerably by type of receiving water and downstream conveyance; therefore, it is very important to determine and specify the receiving water and type of downstream conveyance. Note: there may be multiple downstream receiving waters (e.g., a creek that flows into a small lake). In this case, the minimum requirements for all downstream receiving waters shall apply.

Portions of watersheds near the City limits discharge to adjacent jurisdictions. In these cases, the more stringent requirements between the Seattle Stormwater Code and Manual and the receiving jurisdiction's requirements will be applied for determining stormwater mitigation requirements (e.g., discharges to nutrient-critical receiving waters). Refer to the Phase I and Phase II Municipal Stormwater Permits for enforceable documents that are functionally equivalent to Ecology's requirements.

Seattle has a complicated system due to historical annexations, major sewer and drainage projects, and other complexities. Therefore, prior to proceeding with project design, confirm

[your project discharge location through the City's Preliminary Application Report \(PAR\) process to determine your project requirements. To determine Stormwater Code project requirements for projects that are not required to go through the PAR process, contact the Drainage Review Team at \[sidesewerinfo@seattle.gov\]\(mailto:sidesewerinfo@seattle.gov\) for projects conducted on private property or \[SPU_PlanReview@Seattle.gov\]\(mailto:SPU_PlanReview@Seattle.gov\) for projects conducted in the right-of-way.](#)

[An overview of the types of The receiving waters and systems in Seattle include the following is provided below:](#)

- **Wetlands:** designated under SMC, Section 25.09.020. [Discharges are to the wetland or the associated drainage basin.](#)
- **Creek Basins:** include stream basins throughout Seattle ~~(designated under SMC 801.040 – "C")~~, generally referred to as "creek basins." Discharges are to the creek or the associated drainage basin ~~(example: SMC, Section 22.805.050.C.2)~~. [Creeks in piped systems are considered creeks.](#)
- **Public Combined Sewer:** ~~a publicly owned and maintained system that carries drainage water and wastewater to a publicly owned treatment works (SMC, Section 22.801.170) (Figure 2.8)~~. Discharges are to the public combined sewer or its associated basin.
- **Small Lake Basins:** ~~in Seattle these include Bitter Lake, Green Lake, and Haller Lake (designated under SMC 22.801.200 – "S")~~. Discharges are to the small lake or the associated drainage basin.
- **Designated Receiving Waters:** ~~includes the Duwamish River, Puget Sound, Lake Washington, Lake Union, Elliott Bay, Portage Bay, Union Bay, the Lake Washington Ship Canal, and other receiving waters determined by the Director of Seattle Public Utilities (SPU) and approved by Ecology as having sufficient capacity to receive drainage discharges (Figures 2.9 and 2.10)~~. Discharges are to the designated receiving water or its associated drainage basin.
- **Capacity-Constrained System:** Capacity constraints in any downstream conveyance can modify the flow control requirements for discharges. [This includes discharges directly to the capacity-constrained system or its associated upstream basin. All ditch and culvert systems are capacity constrained. In addition, at the time of publication, the following areas have been determined by the Director to be capacity-constrained:](#)
 - [Densmore Basin](#)
 - [Portions of the Pike/Pine Corridor](#)
 - [South Park \(including both separated storm and combined sewers\)](#)

[Drainage basin and system figures \(references in code reference box\) are provided for reference only.](#)

Stormwater Code Language	References
<p><u>SMC, Section 22.801.040 – “Creek” means a Type S, F, Np or Ns water as defined in WAC 222-16-031, or as defined in WAC 222-16-030 after state water type maps are adopted, and is used synonymously with stream.</u></p> <p><u>SMC, Section 22.801.130 – “Listed creeks” means Blue Ridge Creek, Broadview Creek, Discovery Park Creek, Durham Creek, Frink Creek, Golden Gardens Creek, Kiwanis Ravine/Wolfe Creek, Licton Springs Creek, Madrona Park Creek, Mee-Kwa-Mooks Creek, Mount Baker Park Creek, Puget Creek, Riverview Creek, Schmitz Creek, Taylor Creek, and Washington Park Creek.</u></p> <p><u>SMC, Section 22.801.150 – “Non-listed creeks” means any creek not identified in the definition of “Listed creeks” in 22.801.130.</u></p>	<ul style="list-style-type: none"> • Figure 2.6 and Figure 2.7
<p><u>SMC, Section 22.801.170 – “Public combined sewer” means a publicly owned and maintained system which carries drainage water and wastewater and flows to a publicly owned treatment works.</u></p>	<ul style="list-style-type: none"> • Figure 2.8
<p><u>SMC, Section 22.801.200 – “Small lakes” means Bitter Lake, Green Lake, and Haller Lake.</u></p>	<ul style="list-style-type: none"> • Figure 2.6
<p><u>SMC, Section 22.801.050 – “Designated receiving waters” means the Duwamish River, Puget Sound, Lake Washington, Lake Union, Elliott Bay, Portage Bay, Union Bay, the Lake Washington Ship Canal, and other receiving waters determined by the Director of SPU and approved by Ecology as having sufficient capacity to receive discharges of drainage water such that a site discharging to the designated receiving water is not required to implement flow control.</u></p>	<ul style="list-style-type: none"> • Figure 2.9 and Figure 2.10
<p><u>SMC, Section 22.801.040 – “Capacity-constrained system” means a drainage system or public combined sewer that the Director of SPU has determined to have inadequate capacity to carry existing and anticipated loads, or a drainage system that includes ditches or culverts.</u></p>	<ul style="list-style-type: none"> • Figure 2.11

A Capacity-constrained System is a drainage system or a public combined sewer that the Director of SPU has determined to have inadequate capacity to carry existing and anticipated loads, or a drainage system that includes ditches and culverts. Discharges are to the capacity-constrained system or its associated basin.

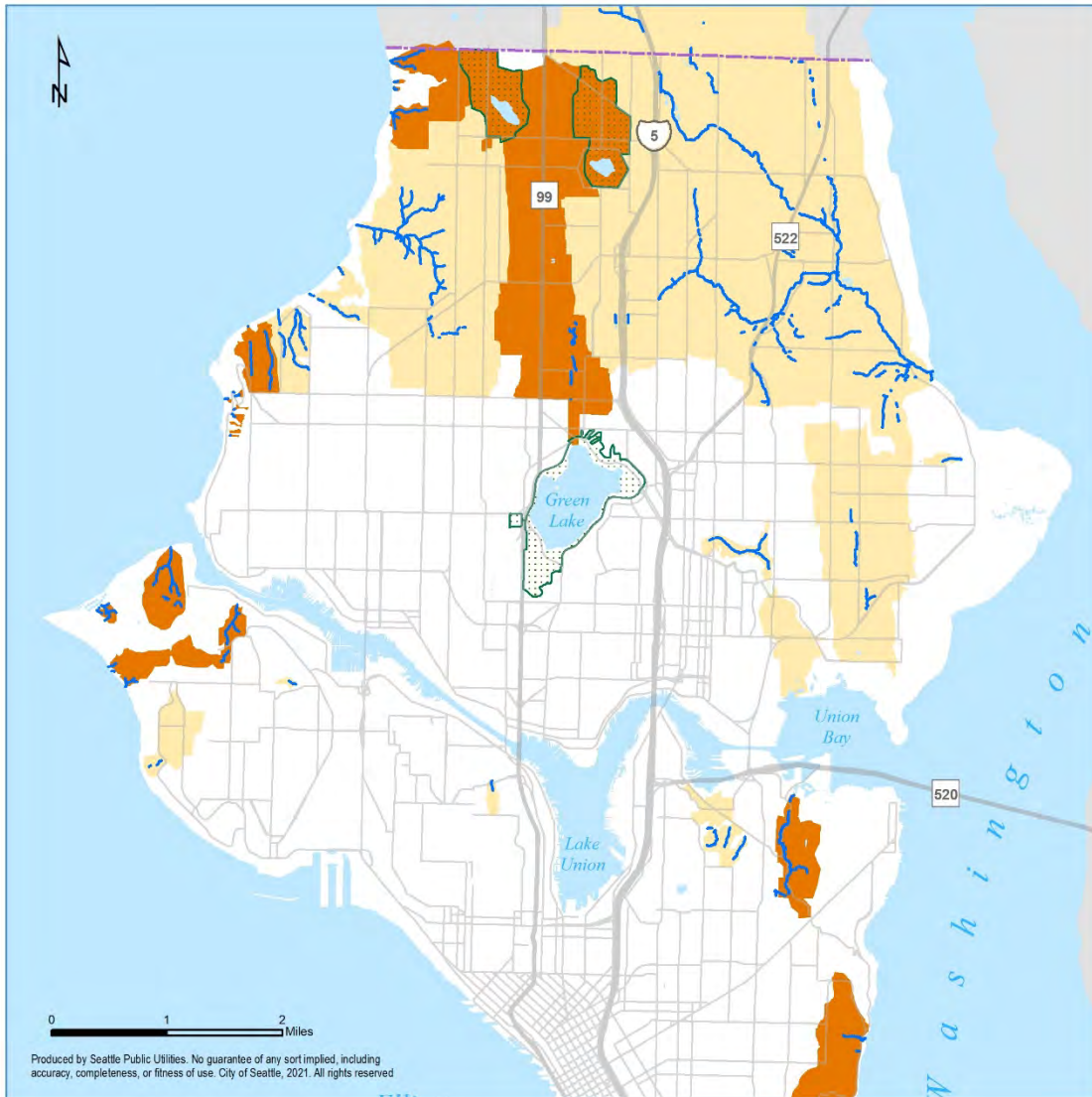
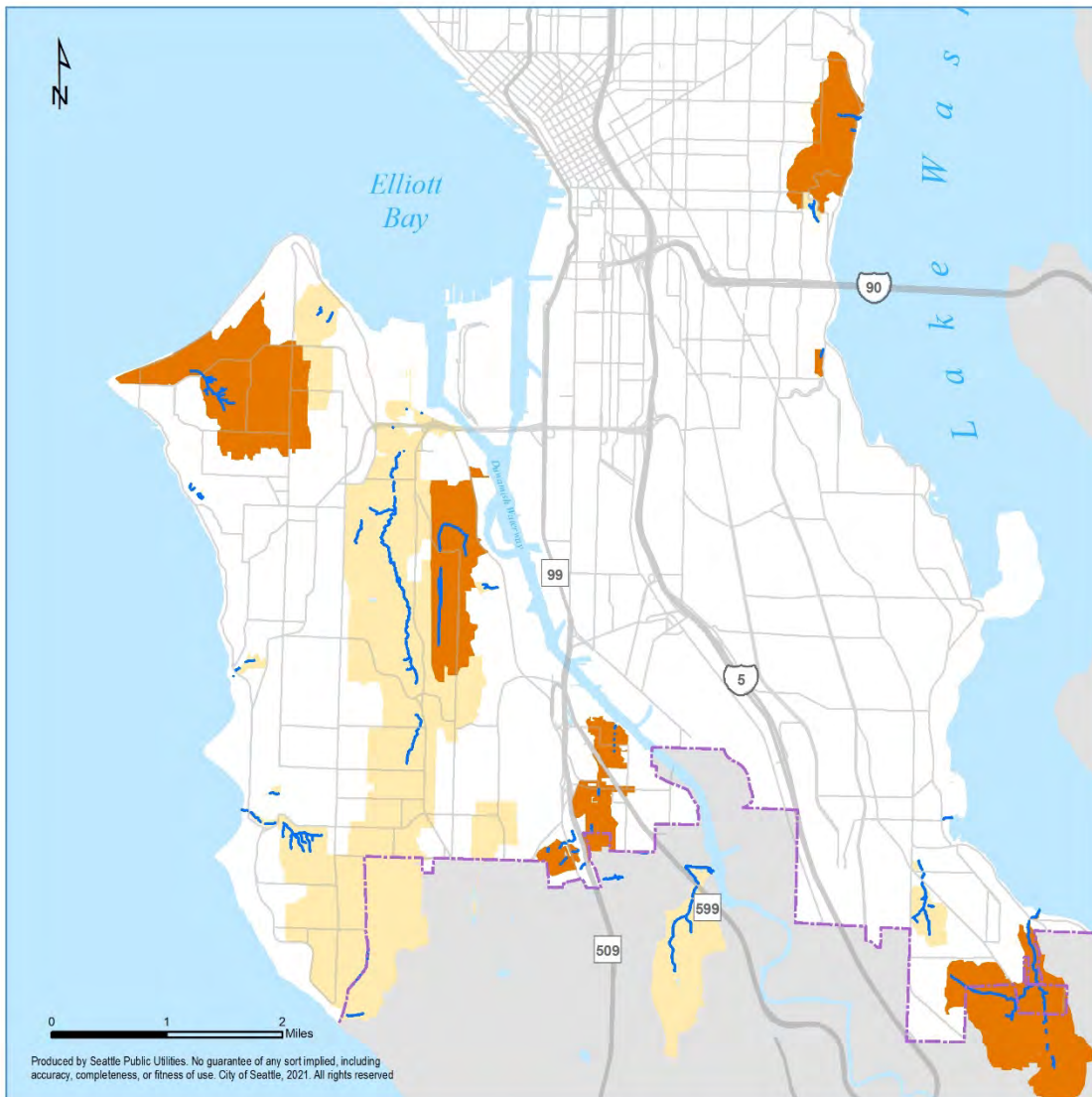

Figure 2.6. North End Creek Basins.



- Creek Watershed (Listed)
- Creek Watershed (Non-Listed)
- Open Stream Channel
- Seattle City Limits

Figure 2.7. South End Creek Basins.

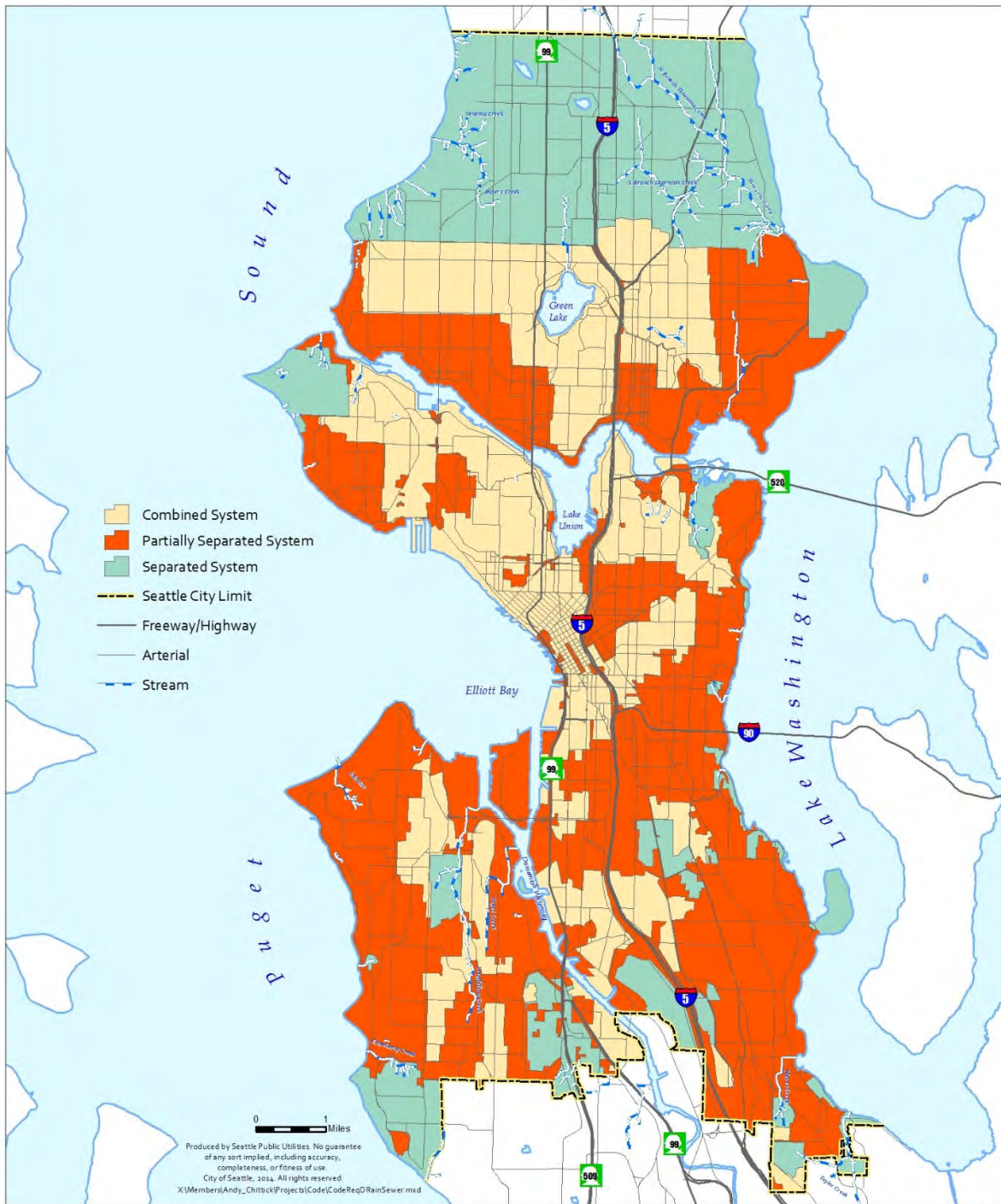
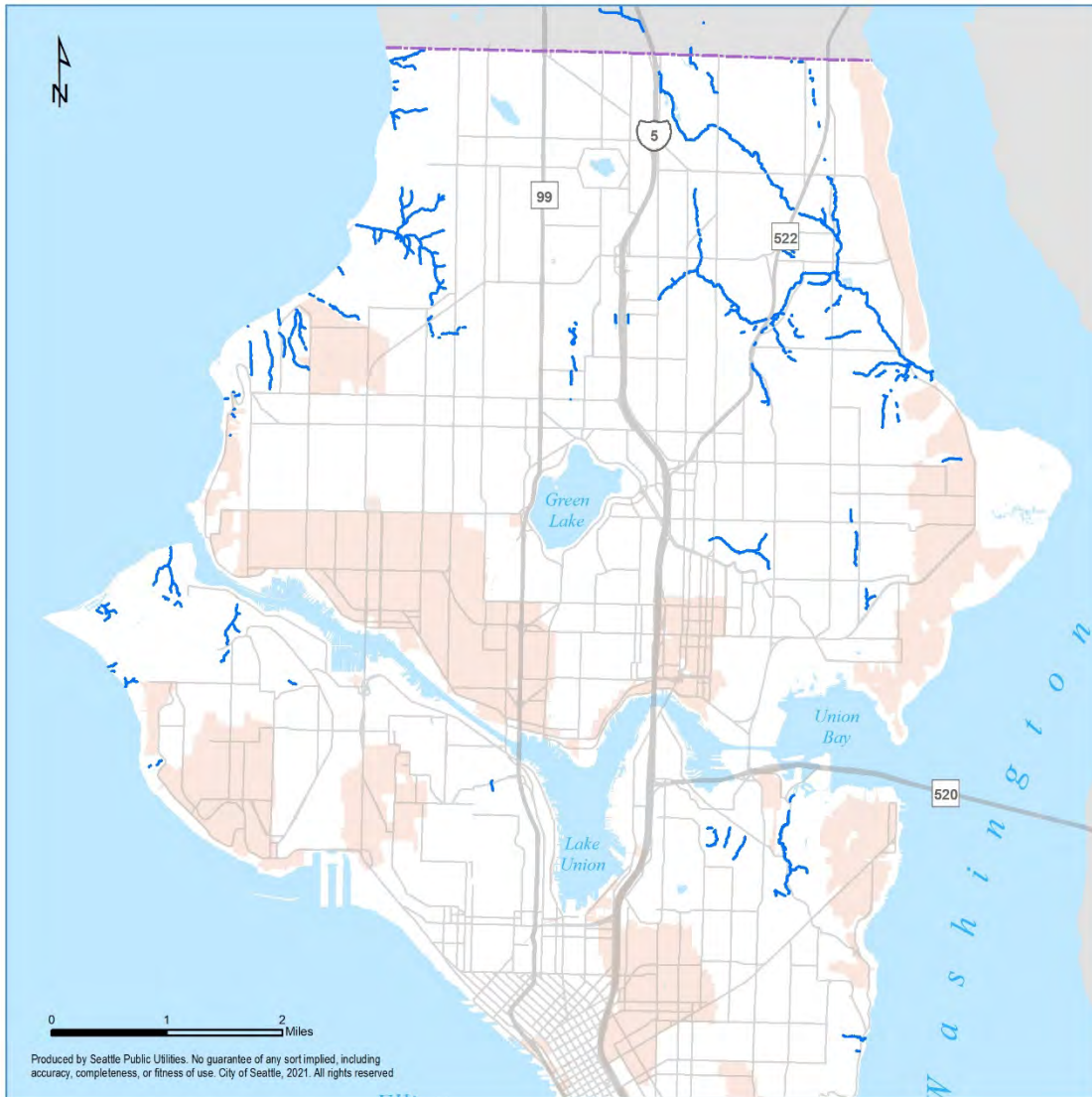

Figure 2.82-6. Public Combined Sewer Basins.





-  Designated Receiving Waterbodies
-  Open Stream Channel
-  Seattle City Limits

Figure 2.92-7. North End Designated Receiving Water Drainage Areas.

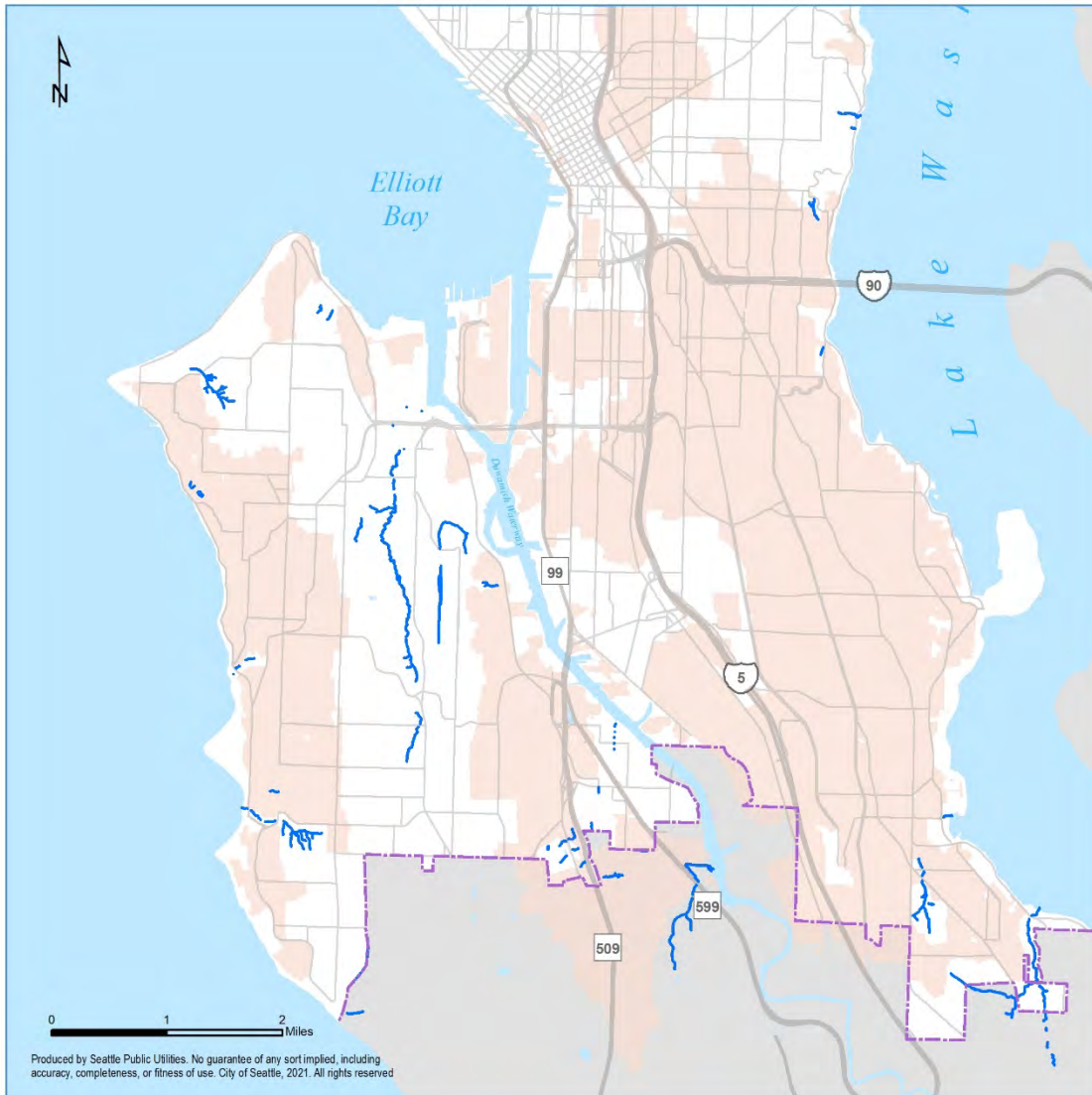
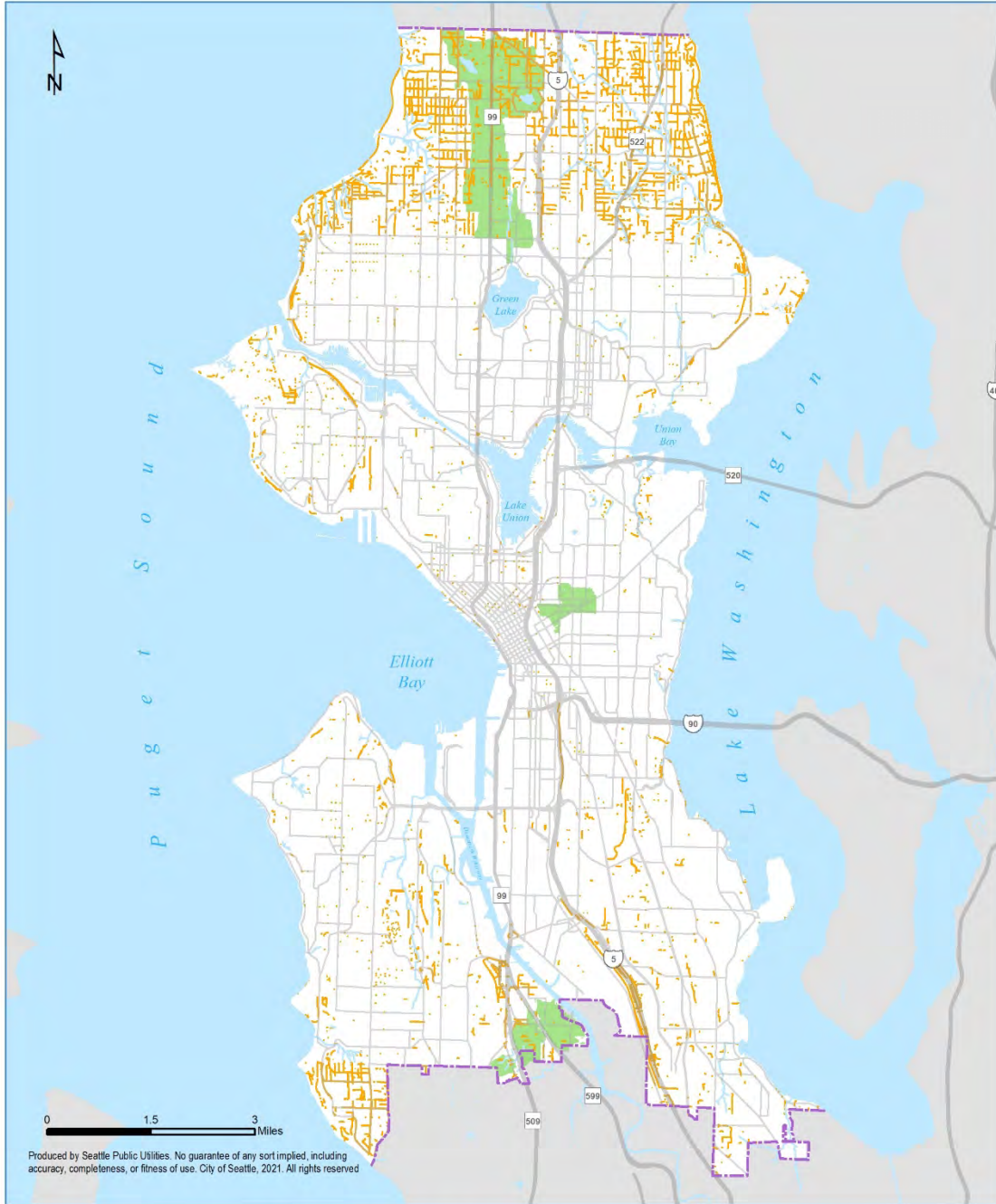

Figure 2.102-8. South End Designated Receiving Water Drainage Areas.



- Capacity Constrained Systems (Director's Rule)
- Ditches and Culverts
- Seattle City Limits

Note: All ditches and culverts are considered to be capacity constrained.

Figure 2.11. Capacity Constrained Systems.

2.4. Step 4 – Perform Site Assessment and Planning

After the applicable minimum requirements have been identified, each project shall evaluate project design considerations and perform a site assessment as outlined in *Chapter 7*. The goal of the site assessment and planning step is to identify any additional issues that shall be addressed in association with stormwater management requirements. This step shall be completed before selecting on-site stormwater management, flow control, and/or treatment BMPs.

Site-specific factors to consider may include, but are not limited to:

- Site boundaries and structures
- [Site topography and dispersion feasibility \(refer to Volume 3, Section 3.1\)](#)
- [Soil conditions and infiltration capacity \(refer to Volume 3, Section 3.2\)](#)
- Critical area issues (e.g., flood plains, landslide prone areas, and site contamination)
- [Groundwater elevations](#)
- [Special circumstances \(e.g., discharge to multiple drainage basins with differing requirements\) \(refer to Section 4.7\)](#)

Project proponents need to evaluate all the applicable code requirements and conduct a full site assessment to characterize site opportunities and constraints before choosing and designing stormwater strategies (refer to *Chapter 7*).

2.5. Step 5 – Calculate Land-Disturbing Activity and New Plus Replaced Hard Surface

The thresholds triggering specific Minimum Requirements for Flow Control are based on the amount of the project's new plus replaced hard surface, converted native and nonnative vegetation, and land-disturbing activity. Hard surface means an impervious surface, a permeable pavement, or a vegetated roof.

Note that open, uncovered retention or detention facilities shall not be considered as [hard impervious](#) surfaces for the purposes of determining whether the minimum requirement thresholds are exceeded. However, these facilities shall be considered impervious surfaces for the purposes of stormwater facility sizing.

Areas with underdrains designed to remove stormwater from the subgrade (e.g., playfields, athletic fields, rail yards) shall be considered as [hard impervious](#) surfaces for the purposes of determining whether the minimum requirement thresholds are exceeded. [All areas that are connected to the underdrains and surrounding underdrain aggregate with free-draining subbase material or drainage layer, such as a sand or gravel layer or a manufactured drainage mat, shall be counted as hard surface area, regardless of the distance of the surface from the underdrain or spacing of underdrains. Natural lawn or turf areas that do not have a free-draining sand or gravel layer or other type of drainage layer connected to the underdrain or underdrain aggregate are considered to be hard surface areas if there are multiple rows of](#)

[underdrains that are spaced closer than 25 feet apart.](#) Refer to SMC, Section 22.801 and *Appendix A* for detailed definitions of these key terms.

The amount of native vegetation that is removed and replaced with lawn, landscaping, and pasture groundcover shall also be calculated.

New plus replaced hard surface areas and converted native vegetation shall be quantified separately for work within, and outside, the right-of-way.

2.6. Step 6 – Calculate New Plus Replaced Pollution Generating Surface

The thresholds triggering specific Minimum Requirements for Treatment are based on the total amount of the project's new plus replaced pollution-generating hard surface (PGHS) and new plus replaced pollution-generating pervious surface (PGPS). PGHS and PGPS include areas that are considered to be a significant source of pollutants in stormwater runoff. Examples of PGHS include areas subject to vehicular use (including permeable pavement); certain industrial activities; outdoor storage of erodible or leachable materials, wastes, or chemicals. Examples of PGPS include lawns, landscaping areas, golf courses, parks, cemeteries, and sports fields (natural and artificial turf). Metal roofs are considered a PGHS unless coated with an inert, non-leachable material (e.g., baked-on enamel coating). Refer to SMC, Section 22.801 and *Appendix A* for detailed definitions of these key terms.

New plus replaced PGHS and PGPS shall be quantified separately for work within and outside the right-of-way.

2.7. Step 7 – Determine Which Minimum Requirements Apply

An overview of the minimum requirements applicable to all project types is included in *Chapter 3*. In addition, an overview of the minimum requirements specific to each project type is included in *Chapter 4*.

Based on the information obtained from Step 1 through Step 6, the applicable minimum requirements for specific project types can be determined for:

- Soil amendment (*Section 5.1*)
- On-site stormwater management (*Section 5.2*)
- Flow control (*Section 5.3*)
- Water quality treatment (*Section 5.4*)

[Note: Other projects that do not trigger the minimum requirements for on-site stormwater management, flow control, and/or water quality \(e.g., retrofit projects\) are encouraged but not required to follow the technical requirements in this manual as guidance on methods and standards that may help protect water resources.](#)

[In addition, certain locations in the City may be subject to additional or modified requirements based on other Director's Rules, Policies, and Tips, such as:](#)

- [SPU Director’s Rule DWW-210 – Public Drainage System Requirements](#)
- [SPU Director’s Rule DWW-430.1 – Flow Control Requirements for Projects in Identified Public Combined Sewer Basins \(SODO/Downtown Waterfront\)](#)
- [SPU Director’s Rule DWW-420.1 – Yesler Terrace Community Director’s Rule: Allowable Stormwater, Groundwater, and Sewer Release Rates to the Combined Sewer System and Infiltration Zones](#)
- [SDCI Tip 505 – High Point Impervious Surface Calculation](#)
- [SDCI Director’s Rule 12-2008 – Infiltration Facilities in Peat Settlement-Prone Areas](#)

[Note: Under certain circumstances, the ECA code requires Water Quality Treatment and Flow Control in some locations where it is not required per this Manual \(e.g., shoreline areas, riparian corridors\).](#)

Once ~~the site conditions are known and~~ the applicable minimum requirements have been identified, proceed to *Volume 3, Chapters 3, 4, and 5* to begin the BMP selection and design process.

CHAPTER 3 – MINIMUM REQUIREMENTS FOR ALL PROJECTS

All projects are required to comply with the minimum requirements listed in SMC, Section 22.805, even when drainage control review is not required. The specifics of the minimum requirements applicable to all projects, as per SMC, Section 22.805.020 are summarized in the following subsections.

Excerpts from the Stormwater Code (in *italics*) are presented below in the first column [in the code reference box](#) in each section. The second column [in the code reference box in each section](#) provides applicable references ~~for further information on how to meet the requirement.~~

Note that this section summarizes but does not replace or alter Stormwater Code requirements.

3.1. Maintaining Natural Drainage Patterns

Stormwater Code Language	References
<p><i>SMC 22.805.020.A – Minimum Requirements for Maintaining Natural Drainage Patterns. For all projects, natural drainage patterns shall be maintained and discharges shall occur at the natural location to the maximum extent feasible and consistent with subsection 22.805.020.B. Drainage water discharged from the site shall not cause a significant adverse impact to receiving waters or down-gradient properties. Drainage water retained or infiltrated on the site shall not cause significant adverse impact to up-gradient or down-gradient properties.</i></p>	<ul style="list-style-type: none"> ● <i>Volume 1, Section 3.2 (SMC, Section 22.805.020.B) – Minimum Requirements for Discharge Point</i> ● <i>Volume 3, Section 3.3 – BMP Selection for On-site Stormwater Management</i> ● <i>Volume 3, Section 3.4 – BMP Selection for Flow Control</i>

3.2. Discharge Point

3.2.1. *Approved Point of Discharge*

All projects shall convey stormwater flow to an approved point of discharge and include overflows for all stormwater BMPs.

Stormwater Code Language	References
<p><i>SMC 22.805.020. B – Minimum Requirements for Discharge Point. The discharge point for drainage water from each site shall be selected using criteria that shall include, but not be limited to, preservation of natural drainage patterns and whether the capacity of the drainage system is adequate for the flow rate and volume. For those projects meeting the drainage review threshold, the proposed discharge point shall be identified in the drainage control plan required by this subtitle, for review and approval or disapproval by the Director.</i></p>	<ul style="list-style-type: none"> • Volume 3, Section 4.3.2 – Approved Point of Discharge

A project's approved point of discharge as determined by the Director, in order of priority, includes:

1. Receiving waters
2. Piped public drainage system (also known as Pipe Storm Drain [PSD])
3. Ditch and culvert system
4. Public combined sewer pipes
5. Infiltration on site

Extension of the piped public drainage system may be required even if a ditch and culvert system or a public combined sewer abuts a project (refer to *Section 3.12* and the Public Drainage System Requirements Director's Rule (SPU Director's Rule DWW-210).

Note: Stormwater and groundwater shall not be conveyed to or enter a sanitary sewer (SMC, Section 21.16.220) including those systems that were considered a formerly combined system.

Refer to SPU's Water & Sewer Map for "Permitted Use" in determining if a system is classified as a public sanitary sewer: https://gisrevprxy.seattle.gov/wab_ext/DSOResearch_Ext/

3.2.2. Conveyance Systems to Point of Discharge

The types of conveyance systems to the approved point of discharge, in order of priority, includes:

1. Direct pipe connections
2. Ditch and culvert system
3. Gutter or street flow line
4. Surface dispersal

3.2.3.3. Flood-Prone Areas

Stormwater Code Language	References
<p><i>SMC 22.805.020.C – Minimum Requirements for Flood-prone Areas. On sites within flood-prone areas, responsible parties are required to employ procedures to minimize the potential for flooding on the site and to minimize the potential for the project to increase the risk of floods on adjacent or nearby properties. Flood control measures shall include those set forth in other titles of the Seattle Municipal Code and rules promulgated thereunder, including, but not limited to, Chapter 23.60 (Shoreline District), Chapter 25.06 (Floodplain Development) and Chapter 25.09 (Environmentally Critical Areas) of the Seattle Municipal Code.</i></p>	<ul style="list-style-type: none"> ● SMC, Chapter 23.60 – Shoreline Master Program ● SMC, Chapter 25.06 – Floodplain Development ● SMC, Chapter 25.09 – Environmentally Critical Areas

3.3.3.4. Construction Site Stormwater Pollution Prevention Control

There are 19 elements required for construction site stormwater pollution prevention control (~~SMC, Section 22.805.020.D~~).

These 19 elements include:

- ~~1. Mark Clearing Limits and Environmentally Critical Areas~~
- ~~2. Retain Top Layer~~
- ~~3. Establish Construction Access~~
- ~~4. Protect Downstream Properties and Receiving Waters~~
- ~~5. Prevent Erosion and Sediment Transport from the Site~~
- ~~6. Prevent Erosion and Sediment Transport from the Site by Vehicles~~
- ~~7. Stabilize Soils~~
- ~~8. Protect Slopes~~
- ~~9. Protect Storm Drains~~
- ~~10. Stabilize Channels and Outlets~~
- ~~11. Control Pollutants~~
- ~~12. Control Dewatering~~
- ~~13. Maintain BMPs~~
- ~~14. Inspect BMPs~~
- ~~15. Execute Construction Stormwater and Erosion Control Plan~~
- ~~16. Minimize Open Trenches~~
- ~~17. Phase the Project~~
- ~~18. Install Flow Control and Water Quality Facilities~~
- ~~19. Protect Stormwater BMPs~~

Stormwater Code Language	References
<p><i>SMC 22.805.020.D – Minimum Requirements for Construction Stormwater Pollution Prevention Plan. Temporary and permanent construction controls shall be used to accomplish [the 19 construction site stormwater pollution prevention control requirements outlined in SMC 22.805.020.D and Volume 2, Construction Stormwater Control]. All projects are required to meet each of the elements below or document why an element is not applicable. Additional controls may be required by the Director when minimum controls are not sufficient to prevent erosion or transport of sediment or other pollutants from the site.</i></p> <ol style="list-style-type: none"> 1. <i>Mark Clearing Limits and Environmentally Critical Areas</i> 2. <i>Retain Top Layer</i> 3. <i>Establish Construction Access</i> 4. <i>Protect Downstream Properties and Receiving Waters</i> 5. <i>Prevent Erosion and Sediment Transport from the Site</i> 6. <i>Prevent Erosion and Sediment Transport from the Site by Vehicles</i> 7. <i>Stabilize Soils</i> 8. <i>Protect Slopes</i> 9. <i>Protect Storm Drains</i> 10. <i>Stabilize Channels and Outlets</i> 11. <i>Control Pollutants</i> 12. <i>Control Dewatering</i> 13. <i>Maintain BMPs</i> 14. <i>Inspect BMPs</i> 15. <i>Execute Construction Stormwater Control and Soil Management Plan</i> 16. <i>Minimize Open Trenches</i> 17. <i>Phase the Project</i> 18. <i>Install Flow Control and Water Quality Facilities</i> 19. <i>Protect Stormwater BMPs</i> 	<ul style="list-style-type: none"> ● <i>Volume 2, Chapter 3 – Selecting Construction Stormwater Controls</i>

3.4.3.5. Protect Wetlands

Stormwater Code Language	References
<p><i>SMC 22.805.020.E – Protect Wetlands. All projects discharging into a wetland or its buffer, either directly or indirectly through a drainage system, shall prevent impacts to wetlands that would result in a net loss of functions or values.</i></p>	<ul style="list-style-type: none"> ● <i>SMC, Chapter 25.09 – Environmentally Critical Areas</i> ● Guide sheets 1 through 3 in the SWMMWW Volume I, Appendix I-CD (Ecology 20192014)

3.5.3.6. Protect Streams and Creeks

Stormwater Code Language	References
<p><i>SMC 22.805.020.F – Protect Streams and Creeks. All projects, including projects discharging directly to a stream or creek, or to a drainage system that discharges to a stream or creek, shall maintain the water quality in any affected stream or creek by selecting, designing, installing, and maintaining temporary and permanent controls.</i></p>	<ul style="list-style-type: none"> • None provided

3.6.3.7. Protect Shorelines

Stormwater Code Language	References
<p><i>SMC 22.805.020.G – Protect Shorelines. All projects discharging directly or indirectly through a drainage system into the shoreline district as defined in Chapter 23.60 shall prevent impacts to water quality and stormwater quantity that would result in a net loss of shoreline ecological functions as defined in WAC 173-26-020 (13).</i></p>	<ul style="list-style-type: none"> • SMC, Chapter 23.60 – Shoreline Master Program • WAC, Section 173-26-020(11) – Definitions – “Document of Record”

3.7.3.8. Ensure Sufficient Capacity

Stormwater Code Language	References
<p><i>SMC 22.805.020.H – Ensure Sufficient Capacity. All large projects, all projects with an excavation depth of 12 feet or more below the existing grade, and all projects with an excavation depth of less than 12 feet located in an area expected to have shallow groundwater depths, shall ensure that sufficient capacity exists in the public drainage system and public combined sewer to carry existing and anticipated loads, including any flows from dewatering activities. Capacity analysis shall extend to at least 1/4-mile from the discharge point of the site. Sites at which there is insufficient capacity may be required to install a flow control facility or improve the drainage system or public combined sewer to accommodate flow from the site. Unless approved otherwise by the Director as necessary to meet the purposes of this subtitle:</i></p> <ol style="list-style-type: none"> <i>1. Capacity analysis for discharges to the public drainage system shall be based on peak flows with a 4 percent annual probability (25-year recurrence interval); and</i> <i>2. Capacity analysis for discharges to the public combined sewer shall be based on peak flows with a 20 percent annual probability (5-year recurrence interval).</i> 	<ul style="list-style-type: none"> • Volume 3, Section 4.3 – Conveyance General Design Requirements • Appendix F – Hydrologic Analysis and Design • SMC, Section 22.805.020.N – Public Drainage System Requirements CAM 1180 – Design Guidelines for Public Storm Drain Facilities • Public Drainage System Requirements Director's Rule DWW-210

3.8.3.9. Install Source Control BMPs

Stormwater Code Language	References
<p><i>SMC 22.805.020.I – Install Source Control BMPs. Source control BMPs shall be installed for discharges, properties, and by businesses and public entities for specific pollution-generating activities as specified in Chapter 22.803 and in the joint SPU/SDCI Directors' Rule titled “Seattle Stormwater Manual” at “Volume 4 – Source Control,” to the extent necessary to prevent prohibited discharges as described in</i></p>	<ul style="list-style-type: none"> • SMC, Section 22.802.020 – Prohibited Discharges • Volume 4 – Source Control

Stormwater Code Language	References
<p><i>Section 22.802.020, and to prevent contaminants from coming in contact with drainage water. This requirement applies to the pollution-generating activities that are stationary or occur in one primary location and to the portion of the site being developed. Examples of installed source controls include, but are not limited to, the following:</i></p> <ol style="list-style-type: none"> 1. <i>A roof, awning, or cover erected over the pollution-generating activity area;</i> 2. <i>Ground surface treatment in the pollution-generating activity area to prevent interaction with, or breakdown of, materials used in conjunction with the pollution-generating activity;</i> 3. <i>Containment of drainage from the pollution-generating activity to a closed sump or tank. Contents of such a sump or tank must be pumped or hauled by a waste handler, or treated prior to discharge to a public drainage system;</i> 4. <i>Construct a berm or dike to enclose or contain the pollution-generating activities;</i> 5. <i>Direct drainage from containment area of pollution-generating activity to a closed sump or tank for settling and appropriate disposal, or treat prior to discharging to a public drainage system;</i> 6. <i>Pave, treat, or cover the containment area of pollution-generating activities with materials that will not interact with or break down in the presence of other materials used in conjunction with the pollution-generating activity; and</i> 7. <i>Prevent precipitation from flowing or being blown onto containment areas of pollution-generating activities.</i> 	

3.9.3.10. Do Not Obstruct Watercourses

Stormwater Code Language	References
<p><i>SMC 22.805.020.J – Do not obstruct watercourses. Watercourses shall not be obstructed.</i></p>	<ul style="list-style-type: none"> • SMC, Chapter 22.808 – Stormwater Code Enforcement

3.10.3.11. Comply with Side Sewer Code

A side sewer permit is required for any repair, replacement or alteration of the sewer or drainage system. Any change to the point of discharge must be approved. A change of use that introduces contaminants or process water to the drainage system, public combined sewer, or public sanitary sewer must also be approved and may require pretreatment. For information on side sewer permits, contact the [Seattle Department of Construction and Inspection \(SDCI\)](#) Drainage and Sewer Review Desk, at (206) 684-5362 or sidewerinfo@seattle.gov. For information on King County discharge requirements, contact the Industrial Waste Program at (206) 477-5300 or Info.KCIW@kingcounty.gov.

Stormwater Code Language	References
<p><i>SMC 22.805.020.K – Comply with Side Sewer Code</i></p> <ol style="list-style-type: none"> 1. <i>All privately owned and operated drainage control facilities or systems, whether or not they discharge to a public drainage</i> 	<ul style="list-style-type: none"> • SMC, Chapter 21.16 – Side Sewer Code

Stormwater Code Language	References
<p>system or public combined sewer, shall be considered side sewers and subject to Chapter 21.16 (Side Sewer Code), SPU Director's Rules promulgated under Title 21, and the design and installation specifications and permit requirements of SPU and SDCI for side sewer and drainage systems.</p> <p>2. Side sewer permits and inspections shall be required for constructing, capping, altering, or repairing privately owned and operated drainage systems as provided for in Chapter 21.16. When the work is ready for inspection, the permittee shall notify the Director. the work is not constructed according to the plans approved under this subtitle, Chapter 21.16, the SPU Director's Rules promulgated under Title 21, and SPU and SDCI design and installation specifications, then the Director may issue a stop work order under Chapter 22.808 and require modifications as provided for in this subtitle and Chapter 21.16.</p>	<ul style="list-style-type: none"> ● SMC, Chapter 22.808 – Stormwater Code Enforcement ● Volume 5 – Enforcement

3.12. Extension of Public Drainage System

3.12.1. Projects Not Constructed in the Right-of-Way

Stormwater Code Language	References
<p><u>SMC 22.805.020.L</u> – <u>Extension of the Public Drainage System for Projects Not Constructed in the Public Right-of-Way. For projects not constructed in the public right-of-way, extension of the piped public drainage system across the full extent of the parcel boundary in the abutting public place shall be required for any of the following:</u></p> <p>1. <u>All projects where the Director has determined an extension is required considering, but not limited to, the following attributes of the project:</u></p> <ul style="list-style-type: none"> a. <u>Poses a hazard to public health, safety, or welfare;</u> b. <u>Endangers any property;</u> c. <u>Adversely affects the safety and operation of public right-of-way, utilities, or other property owned or maintained by the City;</u> d. <u>Adversely affects the functions and values of an environmentally critical area or buffer;</u> e. <u>Adversely affects an area with known erosion or flooding problems; or</u> f. <u>Adversely affects receiving waters, any properties, or right-of-way.</u> <p>2. <u>All projects with 5,000 square feet or more of new plus replaced hard surface, unless:</u></p> <ul style="list-style-type: none"> a. <u>The piped public drainage system is already accessible within an abutting public place to each existing, proposed, or adjusted parcel; or</u> b. <u>The project is otherwise not required to extend by rules promulgated by the Director.</u> 	<ul style="list-style-type: none"> ● <u>Public Drainage System Requirements Director's Rule DWW-210</u>

3.12.2. Projects Constructed in the Right-of-Way

Stormwater Code Language	References
<p><u>SMC 22.805.020.M – Extension of the Public Drainage System for Projects Constructed in the Public Right-of-Way. For projects constructed in the public right-of-way, extension of the piped public drainage system across the full extent of the site shall be required for any of the following:</u></p> <ol style="list-style-type: none"> <u>1. All projects where the Director has determined an extension is required considering, but not limited to, the following attributes of the project:</u> <ol style="list-style-type: none"> <u>a. Poses a hazard to public health, safety, or welfare;</u> <u>b. Endangers any property;</u> <u>c. Adversely affects the safety and operation of City right-of-way, utilities, or other property owned or maintained by the City;</u> <u>d. Adversely affects the functions and values of an environmentally critical area or buffer;</u> <u>e. Adversely affects an area with known erosion or flooding problems; or</u> <u>f. Adversely affects receiving waters, any properties, or right-of-way.</u> <u>2. The project's total new plus replaced hard surface is 50 percent or more of the existing hard surfaces within the project limits. The project limits are defined by the length of the project and the width of the right-of-way. If a project encompasses more than one intersection, the project limits are further defined by one intersection to the other and blocks may vary in length, unless:</u> <ol style="list-style-type: none"> <u>a. The piped public drainage system is already accessible within the site across the full extent of the site; or</u> <u>b. The project is otherwise not required to extend by rules promulgated by the Director.</u> 	<ul style="list-style-type: none"> ● <u>Public Drainage System Requirements Director's Rule DWW-210</u>

3.13. Public Drainage System Requirements

Stormwater Code Language	References
<p><u>SMC 22.805.020.N – Public Drainage System Requirements. Public drainage systems shall be constructed in accordance with the City's Standard Plans and Specifications, SPU's Design Standards and Guidelines, and as specified in rules promulgated by the Director of SPU.</u></p>	<ul style="list-style-type: none"> ● <u>City of Standard Specifications for Road, Bridge, and Municipal Construction</u> ● <u>City of Seattle Standard Plans for Municipal Construction</u> ● <u>SPU Design Standards and Guidelines</u> ● <u>Public Drainage System Requirements Director's Rule DWW-210</u>

3.11.3.14. Maintenance and Inspection

Projects that construct on-site stormwater management, flow control, and water quality treatment BMPs shall comply with the maintenance and inspection requirements specified in SMC, Section 22.807.090.

Stormwater Code Language	References
<p><i>SMC 22.807.090 –</i></p> <p><i>A. Responsibility for Maintenance and Inspection. The owner and other responsible parties shall maintain drainage control facilities, source controls, and other facilities and implement landscape management plans required by this subtitle and by rules adopted hereunder to keep these facilities in continuous working order. The owner and other responsible parties shall inspect permanent drainage control facilities, temporary drainage control facilities, and other temporary best management practices or facilities on a schedule consistent with this subtitle and sufficient for the facilities to function at design capacity. The Director may require the responsible party to conduct more frequent inspections and/or maintenance when necessary to ensure functioning at design capacity. The owner(s) shall inform future purchasers and other successors and assignees to the property of the existence of the drainage control facilities and the elements of the drainage control plan, the limitations of the drainage control facilities, and the requirements for continued inspection and maintenance of the drainage control facilities and for implementation of a landscape management plan, if applicable.</i></p> <p><i>B. Inspection by City. The Director of SPU may establish inspection programs to evaluate and, when required, enforce compliance with the requirements of this subtitle and accomplishment of its purposes. Inspection programs may be established on any reasonable basis, including, but not limited to: routine inspections; random inspections; inspections based upon complaints or other notice of possible violations; inspection of drainage basins or areas identified as higher than typical sources of sediment or other contaminants or pollutants; inspections of businesses or industries of a type associated with higher than usual discharges of contaminants or pollutants or with discharges of a type more likely than the typical discharge to cause violations of state or federal water or sediment quality standards or the City's NPDES stormwater permit; and joint inspections with other agencies inspecting under environmental or safety laws. Inspections may include, but are not limited to: reviewing maintenance and repair records; sampling discharges, surface water, groundwater, and material or water in drainage control facilities; and evaluating the condition of drainage control facilities and other best management practices.</i></p>	<ul style="list-style-type: none"> ● Appendix G – Stormwater Control Operations and Maintenance Requirements ● Appendix I –Landscape Management Plans and Integrated Pest Management Plans

CHAPTER 4 – MINIMUM REQUIREMENTS BASED ON PROJECT TYPE

In addition to the minimum requirements for all projects presented in *Chapter 3*, additional requirements apply based upon project type and are summarized in this chapter. Project types are defined in *Chapter 2, Step 2*.

Excerpts from the Stormwater Code (in *italics*) are presented in the first column [in the code reference box](#) in each section. The second column [in the code reference box in each section](#) provides applicable references.

Flow charts are included in the roadway and parcel-based project sections (*Sections 4.3 and 4.4*) to summarize the key minimum requirements. Utility and pavement maintenance project types are exempt from certain minimum requirements (refer to *Sections 4.5 and 4.6* for additional information). This chapter also includes a short section on WSDOT projects (*Section 4.64.7*) and special circumstances (*Section 4.74.8*), applicable when a project does not fit into the other project type categories.

The key minimum requirements include the following:

- Soil Amendment
- On-site Stormwater Management
- Wetland Protection Standard
- Pre-developed Forested Standard
- Pre-developed Pasture Standard
- Peak Control Standard
- Basic Treatment
- Oil Treatment
- Phosphorus Treatment
- Enhanced Treatment

The standards are described in more detail in *Chapter 5*. For each project type, the minimum requirements are a function of the following factors (refer to *Chapter 2*):

- The receiving water and/or type of downstream conveyance
- The amount of new plus replaced hard surface (Note: permeable pavement, vegetated roof systems, and areas with underdrains count toward determining this threshold.)
- The amount of converted native vegetation
- The amount of new plus replaced pollution-generating hard surface (PGHS)
- The amount of new plus replaced pollution-generating pervious surface (PGPS)

In addition, certain locations in the City may be subject to additional or modified requirements based on additional Director’s Rules, Policies, other Codes (e.g., ECA Code) or past agreements. For example, such areas include parts of the SODO and Downtown waterfront areas, the Yesler Terrace Development, the High Point Re-development, Peat Settlement Prone ECAs. Refer to Step 7 (*Section 2.7*) for more information.

4.1. Single-Family Residential Projects

The applicable code language and references for single-family residential projects are summarized below. Note that single-family residential projects are not required to install flow control or water quality treatment BMPs since the project type, by definition, does not trigger the minimum requirements for flow control or water quality treatment unless they are requirements of the master use permit associated with the single-family project as described in Section 2.2.1.

Stormwater Code Language	References
<p>SMC 22.805.030 –</p> <p>A. <i>Soil Amendment. Retain and protect undisturbed soil in areas not being developed, and prior to completion of the project, amend all new, replaced, and disturbed topsoil (including construction lay-down areas) with organic matter to the extent required by and in compliance with the rules promulgated by the Director.</i></p> <p>B. <i>On-site Stormwater Management. Single-family residential projects shall meet the Minimum Requirements for On-site Stormwater Management contained in Section 22.805.070, to the extent allowed by law, if:</i></p> <ol style="list-style-type: none"> 1. <i>For a project on a lot most recently created, adjusted, altered, or otherwise amended by a plat or other lawful document recorded with the King County Recorder on or after January 1, 2016, and where that document either created the lot or altered the size of the lot, either the total new plus replaced hard surface is 750 square feet or more or land disturbing activity is 7,000 square feet or more; or</i> 2. <i>For any other project, either the total new plus replaced hard surface is 1,500 square feet or the land disturbing activity is 7,000 square feet or more.</i> 	<ul style="list-style-type: none"> ● Volume 1, Section 2.2.1 – Single-Family Residential Project ● Volume 1, Section 5.1 (SMC, Section 22.805.030) – Soil Amendment ● Volume 1, Section 5.2 (SMC, Section 22.805.070) – On-site Stormwater Management ● Volume 3, Section 3.3 – BMP Selection for On-Site Stormwater Management

4.2. Trail and Sidewalk Projects

The applicable code language and references for trail and sidewalk projects are summarized below. Note that trail and sidewalk projects are not required to install flow control or water quality treatment BMPs if the project meets the definition of a trail or sidewalk project.

Stormwater Code Language	References
<p><i>SMC 22.805.040 –</i></p> <p><i>A. Soil Amendment. Retain and protect undisturbed soil in areas not being developed, and prior to completion of the project, amend all new, replaced, and disturbed topsoil (including construction lay-down areas) with organic matter to the extent required by and in compliance with the rules promulgated by the Director.</i></p> <p><i>B. On-site Stormwater Management: All trail and sidewalk projects with 2,000 square feet or more of new plus replaced hard surface or 7,000 square feet or more of land disturbing activity shall meet Minimum Requirements for On-site Stormwater Management contained in Section 22.805.070, to the extent allowed by law.</i></p>	<ul style="list-style-type: none"> ● Volume 1, Section 2.2.2 – Sidewalk Project ● Volume 1, Section 2.2.3 – Trail Project ● Volume 1, Section 5.1 (SMC, Section 22.805.040)– Soil Amendment ● Volume 1, Section 5.2 (SMC, Section 22.805.070)– On-site Stormwater Management ● Volume 3, Section 3.3 – BMP Selection for On-Site Stormwater Management

4.3. Roadway Projects

Roadway projects shall meet the minimum requirements for soil amendment (SMC, Section 22.805.060.A), on-site stormwater management (SMC, Section 22.805.020.F), flow control (SMC, Section 22.805.080) and water quality treatment (SMC, Section 22.805.090) when applicable. Key minimum requirements for roadway projects are summarized in Figures 4.1a through 4.1c. In addition to meeting a forested, pasture, or wetland protection standard, projects discharging to a capacity-constrained system will also be required to meet the peak control standard.

4.3.1. Soil Amendment

Stormwater Code Language	References
SMC 22.805.060.A – Retain and protect undisturbed soil in areas not being developed, and prior to completion of the project, amend all new, replaced, and disturbed topsoil (including construction lay-down areas) with organic matter to the extent required by and in compliance with the rules promulgated by the Director.	<ul style="list-style-type: none"> Volume 1, Section 5.1 (SMC, Section 22.805.060.A) – Soil Amendment

4.3.2. On-site Stormwater Management

Stormwater Code Language	References
SMC 22.805.060.B – All roadway projects with 2,000 square feet or more of new plus replaced hard surface or 7,000 square feet or more of land disturbing activity shall meet the Minimum Requirements for On-site Stormwater Management contained in Section 22.805.070, to the extent allowed by law, except as provided in subsection 22.805.060.E.	<ul style="list-style-type: none"> Volume 1, Section 2.2.4 – Roadway Project Volume 1, Section 5.2 (SMC, Section 22.805.070) – On-site Stormwater Management Volume 3, Section 3.3 – BMP Selection for On-site Stormwater Management

4.3.3. Flow Control

4.3.3.1. Roadway Projects Discharging to Wetlands – Flow Control

Stormwater Code Language	References
SMC 22.805.060.C.1 – Discharges to Wetlands. Roadway projects discharging into a wetland or to the drainage basin of a wetland, shall: <ol style="list-style-type: none"> Comply with Section 22.805.020 (Minimum requirements for all projects), including, but not limited to subsection 22.805.020.E (Protect Wetlands). Comply with the minimum requirements for wetland protection contained in subsection 22.805.080.B.1 (Wetland Protection Standards) if the existing hard surface coverage is less than 35 percent and one or more of the following apply: <ol style="list-style-type: none"> The total new plus replaced hard surface is 5,000 square feet or more; or 	<ul style="list-style-type: none"> SMC, Section 22.805.080.B.1 – Wetland Protection Standards Volume 1, Section 2.2.4 – Roadway Project Volume 1, Section 3.5 (SMC, Section 22.805.020.E) – Protect Wetlands Guide sheets 1 through 3 in the SWMMWW Volume I, Appendix I-CD (Ecology 20192014)

<p>2. <i>The project converts 3/4 acres or more of vegetation to lawn or landscaped areas, and from the project there is a surface discharge into a natural or constructed conveyance system from the site; or</i></p> <p>3. <i>The project converts 2.5 acres or more of native vegetation to pasture and from the project there is a surface discharge into a natural or constructed conveyance system from the site.</i></p> <p>c. <i>Comply with the minimum requirements for wetland protection contained in subsection 22.805.080.B.1 (Wetland Protection Standards) if the existing hard surface coverage is greater than or equal to 35 percent and one or more of the following apply:</i></p> <p>1. <i>The total new hard surface is 10,000 square feet or more; or</i></p> <p>2. <i>The project converts 3/4 acres or more of vegetation to lawn or landscaped areas, and from the project there is a surface discharge into a natural or constructed conveyance system from the site; or</i></p> <p>3. <i>The project converts 2.5 acres or more of native vegetation to pasture and from the project there is a surface discharge into a natural or constructed conveyance system from the site.</i></p>	
---	--

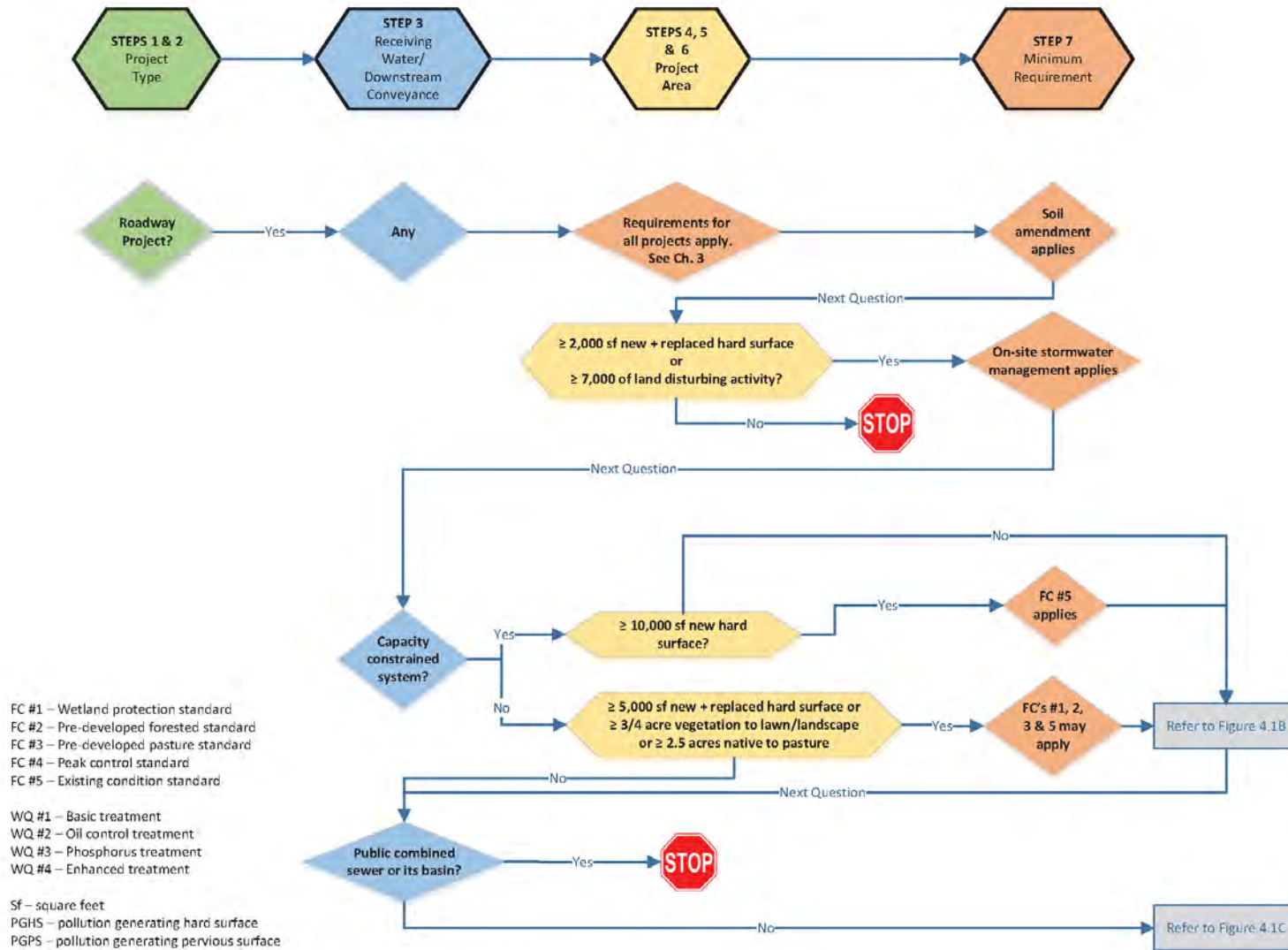

Figure 4.1A. Project Minimum Requirements Overview Flow Chart for Roadway Projects.

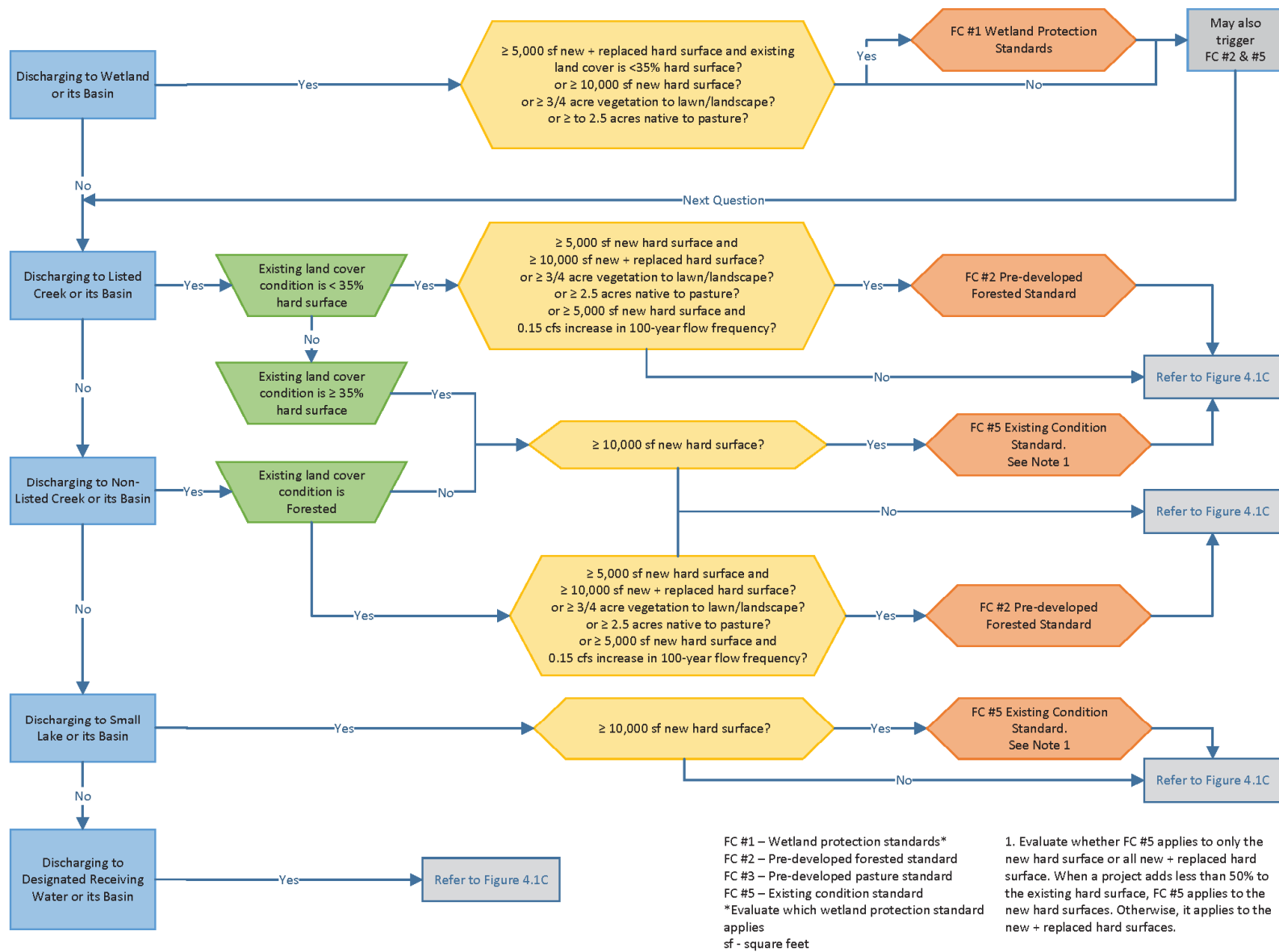

Figure 4.1B. Flow Control Project Minimum Requirements for Roadway Projects (continued).

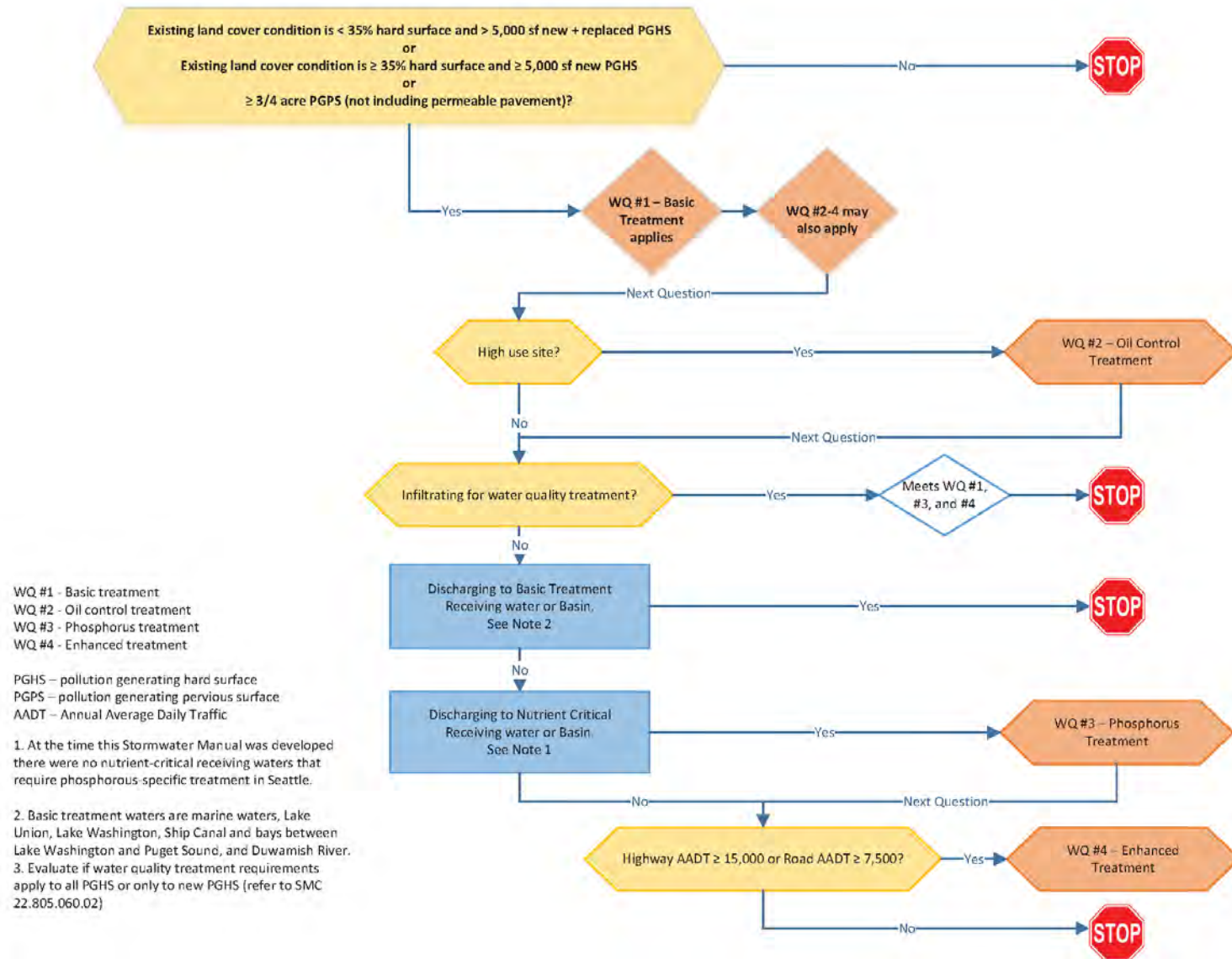

Figure 4.1C. [Project Water Quality Treatment](#) Minimum Requirements for Roadway Projects (continued).

4.3.3.2. Roadway Projects Discharging to Listed Creek Basins – Flow Control

Stormwater Code Language	References
<p>SMC 22.805.060.C.2 – Roadway projects discharging into Blue Ridge Creek, Broadview Creek, Discovery Park Creek, Durham Creek, Frink Creek, Golden Gardens Creek, Kiwanis Ravine/Wolfe Creek, Licton Springs Creek, Madrona Park Creek, Mee-Kwa-Mooks Creek, Mount Baker Park Creek, Puget Creek, Riverview Creek, Schmitz Creek, Taylor Creek, or Washington Park Creek, or to the drainage basin of such creek, shall:</p> <ol style="list-style-type: none"> a. Comply with subsection 22.805.080.B.2 (Pre-developed Forested Standard) if the existing hard surface coverage is less than 35 percent and one or more of the following apply: <ol style="list-style-type: none"> 1. The project adds 5,000 square feet or more of new hard surface and the total new plus replaced hard surface is 10,000 square feet or more; or 2. The project converts 3/4 acres or more of vegetation to lawn or landscaped areas, and from the project there is a surface discharge into a natural or constructed conveyance system from the site; or 3. The project converts 2.5 acres or more of native vegetation to pasture, and from the project there is a surface discharge into a natural or constructed conveyance system from the site; or 4. The project adds 5,000 square feet or more of new hard surface and, through a combination of effective hard surfaces and converted pervious surfaces, causes a 0.15 cubic feet per second increase in the 100-year recurrence interval flow frequency as estimated using a continuous model approved by the Director. b. Comply with subsection 22.805.080.B.4 (Existing Condition Standard) if the criteria in subsection 22.805.060.C.2.a do not apply and the total new hard surface is 10,000 square feet or more, and: <ol style="list-style-type: none"> 1. If the new hard surface adds 50 percent or more to the existing hard surfaces within the project limits, comply with subsection 22.805.080.B.4 (Existing Condition Standard) for the flows from the total new plus replaced hard surfaces. The project limits are defined by the length of the project and the width of the right-of-way; or 2. If the new hard surface adds less than 50 percent to the existing hard surfaces within the project limits, comply with subsection 22.805.080.B.4 (Existing Condition Standard) for the flows from the total new hard surfaces. The project limits are defined by the length of the project and the width of the right-of-way. 	<ul style="list-style-type: none"> ● SMC, Section 22.805.080.B.2 – Pre-developed Forested Standard ● SMC, Section 22.805.080.B.3 – Pre-developed Pasture Standard ● SMC, Section 22.805.080.B.4 – Existing Condition Standard ● Volume 1, Section 2.2.4 – Roadway Project ● Volume 3, Section 3.4 – BMP Selection for Flow Control ● Volume 3, Section 4.1 – Sizing Approach

4.3.3.3. Roadway Projects Discharging to Non-listed Creek Basins – Flow Control

Stormwater Code Language	References
<p>SMC 22.805.060.C.3 – Roadway projects discharging into a creek not listed in subsection 22.805.060.C.2, or to the drainage basin of such creek, shall:</p> <p>a. Comply with subsection 22.805.080.B.2 (Pre-developed Forested Standard) if the existing land cover is forested and one or more of the following apply:</p> <ol style="list-style-type: none"> 1. The project adds 5,000 square feet or more of new hard surface and the total new plus replaced hard surface is 10,000 square feet or more; or 2. The project converts 3/4 acres or more of vegetation to lawn or landscaped areas, and from the project there is a surface discharge into a natural or constructed conveyance system from the site; or 3. The project converts 2.5 acres or more of native vegetation to pasture, and from the project there is a surface discharge into a natural or constructed conveyance system from the site; or 4. The project adds 5,000 square feet or more of new hard surface and, through a combination of effective hard surfaces and converted pervious surfaces, causes a 0.15 cubic feet per second increase in the 100-year recurrence interval flow frequency as estimated using a continuous model approved by the Director. <p>b. Comply with subsection 22.805.080.B.4 (Existing Condition Standard) if the criteria in subsection 22.805.060.C.3.a do not apply and the total new hard surface is 10,000 square feet or more, and:</p> <ol style="list-style-type: none"> 1. If the new hard surface adds 50 percent or more to the existing hard surfaces within the project limits, comply with subsection 22.805.080.B.4 (Existing Condition Standard) for the flows from the total new plus replaced hard surfaces. The project limits are defined by the length of the project and the width of the right-of-way; or 2. If the new hard surface adds less than 50 percent to the existing hard surfaces within the project limits, comply with subsection 22.805.080.B.4 (Existing Condition Standard) for the flows from the total new hard surfaces. The project limits are defined by the length of the project and the width of the right-of-way. 	<ul style="list-style-type: none"> ● SMC, Section 22.805.080.B.2 – Pre-developed Forested Standard ● SMC, Section 22.805.080.B.3 – Pre-developed Pasture Standard ● SMC, Section 22.805.080.B.4 – Existing Condition Standard ● Volume 1, Section 2.2.4 – Roadway Project ● Volume 3, Section 3.4 – BMP Selection for Flow Control ● Volume 3, Section 4.1 – Sizing Approach

4.3.3.4. Roadway Projects Discharging to Small Lake Basins – Flow Control

Stormwater Code Language	References
<p>SMC 22.805.060.C.4 – Roadway projects discharging into Bitter Lake, Green Lake, or Haller Lake, or to the drainage basin of such lake, shall comply with subsection 22.805.080.B.4 (Existing Condition Standard) if the total new hard surface is 10,000 square feet or more and:</p> <ol style="list-style-type: none"> If the new hard surface adds 50 percent or more to the existing hard surfaces within the project limits, comply with subsection 22.805.080.B.4 (Existing Condition Standard) for the flows from the total new plus replaced hard surfaces. The project limits are defined by the length of the project and the width of the right-of-way; or If the new hard surface adds less than 50 percent to the existing hard surfaces within the project limits, comply with subsection 22.805.080.B.4 (Existing Condition Standard) for the flows from the total new hard surfaces. The project limits are defined by the length of the project and the width of the right-of-way. 	<ul style="list-style-type: none"> • SMC, Section 22.805.080.B.4 – Peak Control Standard • SMC, Section 22.805.080.B.4 – Existing Condition Standard • Volume 1, Section 2.2.4 – Roadway Project • Volume 3, Section 3.4 – BMP Selection for Flow Control • Volume 3, Section 4.1 – Sizing Approach

~~4.3.3.5. Roadway Projects Discharging to Public Combined Sewer – Flow Control~~

~~At the time this Manual was developed, there was one public combined sewer basin that was determined to have sufficient capacity to carry existing and anticipated loads. Roadway projects are not required to provide peak flow control in this basin. Refer to the SDCI website to determine which basins are included in this category (<http://www.seattle.gov/dpd/codesrules/codes/stormwater/>).~~

Stormwater Code Language	References
<p>SMC 22.805.060.C.5 – Unless the Director of SPU has determined that the public combined sewer has sufficient capacity to carry existing and anticipated loads, roadway projects discharging into the public combined sewer or its basin shall comply with subsection 22.805.080.B.4 (Peak Control Standard) if the total new plus replaced hard surface is 10,000 square feet or more.</p>	<ul style="list-style-type: none"> • SMC, Section 22.805.080.B.4 – Peak Control Standard • Figure 2.6 – Public Combined Sewer Basins • Volume 3, Section 3.4 – BMP Selection for Flow Control • Volume 3, Section 4.1 – Sizing Approach

~~4.3.3.6.4.3.3.5. Roadway Projects Discharging to a Capacity-constrained System – Flow Control~~

Stormwater Code Language	References
<p>SMC 22.805.060.C.5 – In addition to applicable minimum requirements for flow control in subsection 22.805.00.C.1 through subsection 22.805.060.C.4, roadway projects discharging into a capacity-constrained system or its basin shall also comply with subsection 22.805.080.B.4 (Existing Condition Standard) if the total new hard surface is 10,000 square feet or more unless the downstream system only includes ditches or culverts and has been determined to</p>	<ul style="list-style-type: none"> • SMC, Section 22.805.060.C.1 – Discharges to Wetlands • SMC, Section 22.805.060.C.2 – Discharges to Listed Creek Basins • SMC, Section 22.805.060.C.3 – Discharges to Non-listed Creek Basins

Stormwater Code Language	References
<p>have sufficient capacity as specified in 22.805.020.H (Ensure Sufficient Capacity).-</p> <p>SMC 22.801.040 – “Capacity-constrained system” means a drainage system or public combined sewer that the Director of SPU has determined to have inadequate capacity to carry existing and anticipated loads, or a drainage system that includes ditches or culverts.</p>	<ul style="list-style-type: none"> ● SMC, Section 22.805.060.C.4 – Discharges to Small Lake Basins ● SMC, Section 22.805.060.C.5 – Discharges to Public Combined Sewer ● SMC, Section 22.805.080.B.5 – Existing Condition Standard ● SMC, Section 22.805.080.B.54 – Peak Control Standard ● Volume 1, Section 2.2.4 – Roadway Project ● Volume 3, Section 3.4 – BMP Selection for Flow Control ● Volume 3, Section 4.1 – Sizing Approach

~~4.3.3.7.4.3.3.6. Roadway Projects Discharging Groundwater – Flow Control~~

Stormwater Code Language	References
<p>SMC 22.805.060.C.7 – In addition to applicable minimum requirements for flow control in subsection 22.805.060.C.1 through subsection 22.805.060.C.6, roadway projects that will permanently discharge groundwater to a public drainage system or to a public combined sewer shall also comply with subsection 22.805.080.B.4 (Peak Control Standard) if the total new plus replaced hard surface is 10,000 square feet or more.</p>	<ul style="list-style-type: none"> ● SMC, Section 22.805.060.C.7 – Discharges from Groundwater

4.3.4. Water Quality Treatment

Stormwater Code Language	References
<p>SMC 22.805.060.D – Roadway projects not discharging to the public combined sewer shall, to the extent allowed by law, except as provided in subsection 22.805.060.E:</p> <ol style="list-style-type: none"> 1. If the site has less than 35 percent existing hard surface coverage, and the project’s total new plus replaced pollution-generating hard surface is 5,000 square feet or more, comply with the minimum requirements for treatment contained in Section 22.805.090 for flows from the total new plus replaced pollution-generating hard surface and new plus replaced pollution-generating pervious surface; and 2. If the site has greater than or equal to 35 percent existing hard surface coverage and the project’s total new pollution-generating hard surface is 5,000 square feet or more, and <ol style="list-style-type: none"> a. If the new pollution-generating hard surface adds 50 percent or more to the existing hard surfaces within the project limits, comply with the minimum requirements for treatment contained in Section 22.805.090 for flows from the total new plus replaced pollution-generating hard surface and new plus replaced pollution-generating 	<ul style="list-style-type: none"> ● SMC, Section 22.805.090 – Minimum Requirements for Treatment ● Volume 1, Section 2.2.4 – Roadway Project ● Volume 1, Section 5.4 (SMC, Section 22.805.090) – Water Quality Treatment ● Volume 3, Section 3.5 – BMP Selection for Water Quality Treatment ● Volume 3, Section 4.1 – Sizing Approach

<p><i>pervious surface. The project limits are defined by the length of the project and the width of the right-of-way; or</i></p> <p><i>b. If the new pollution-generating hard surface adds less than 50 percent to the existing hard surfaces within the project limits, comply with the minimum requirements for treatment contained in Section 22.805.090 for flows from the total new pollution-generating hard surface and new pollution-generating pervious surface. The project limits are defined by the length of the project and the width of the right-of-way; and</i></p> <p><i>3. If the total new plus replaced pollution-generating pervious surfaces is 3/4 acres or more, and from the project there is a surface discharge in a natural or constructed conveyance system from the site, comply with the minimum requirements for treatment contained in Section 22.805.090 for flows from the total new plus replaced pollution-generating pervious surface and the new plus replaced pollution-generating hard surface.</i></p>	
---	--

4.4. Parcel-Based Projects

Parcel-based projects shall meet the minimum requirements for soil amendment (SMC, Section 22.805.050.A), on-site stormwater management (SMC, Section 22.805.070), flow control (SMC, Section 22.805.080) and water quality treatment (SMC, Section 22.805.090), when applicable. Key minimum requirements for parcel-based projects are summarized in Figures 4.2a through 4.2c. In addition to meeting a forested, pasture, or wetland protection standard, projects discharging to a capacity-constrained system will also be required to meet the peak control standard.

4.4.1. Soil Amendment

Stormwater Code Language	References
<p><i>SMC 22.805.050.A – Retain and protect undisturbed soil in areas not being developed, and prior to completion of the project, amend all new, replaced, and disturbed topsoil (including construction lay-down areas) with organic matter to the extent required by and in compliance with the rules promulgated by the Director.</i></p>	<ul style="list-style-type: none"> • <i>Volume 1, Section 5.1 (SMC, Section 22.805.050.A) – Soil Amendment</i>

4.4.2. On-site Stormwater Management

Stormwater Code Language	References
<p><i>SMC 22.805.050 –</i></p> <p><i>B. On-site Stormwater Management. Parcel-based projects shall meet the Minimum Requirements for On-site Stormwater Management contained in Section 22.805.070, to the extent allowed by law, if:</i></p> <ol style="list-style-type: none"> <i>1. For a project on a lot most recently created, adjusted, altered, or otherwise amended by a plat or other lawful document recorded with the King County Recorder on or after January 1, 2016, and where that document either created the lot or altered the size of the lot, either the total new plus replaced hard surface is 750 square feet or more or land disturbing activity is 7,000 square feet or more; or</i> <i>2. For any other project, either the total new plus replaced hard surface is 1,500 square feet or more or the land disturbing activity is 7,000 square feet or more.</i> 	<ul style="list-style-type: none"> • Volume 1, Section 2.2.5 – Parcel-Based Project • <i>Volume 1, Section 5.2 (SMC, Section 22.805.070) – On-site Stormwater Management</i> • <i>Volume 3, Section 3.3 – BMP Selection for On-site Stormwater Management</i>

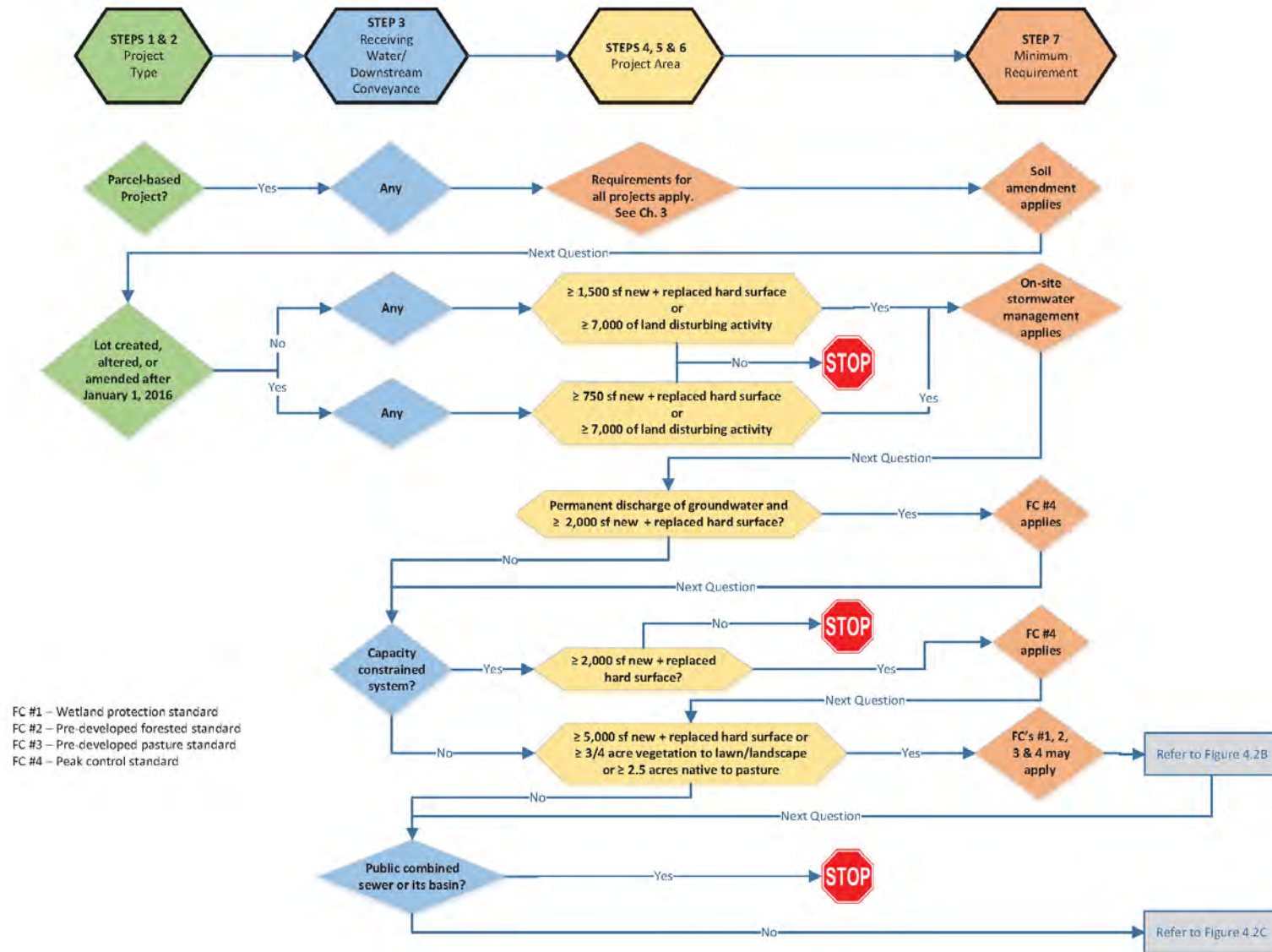

Figure 4.2A. Project Minimum Requirements Overview Flow Chart for Parcel-Based Projects.

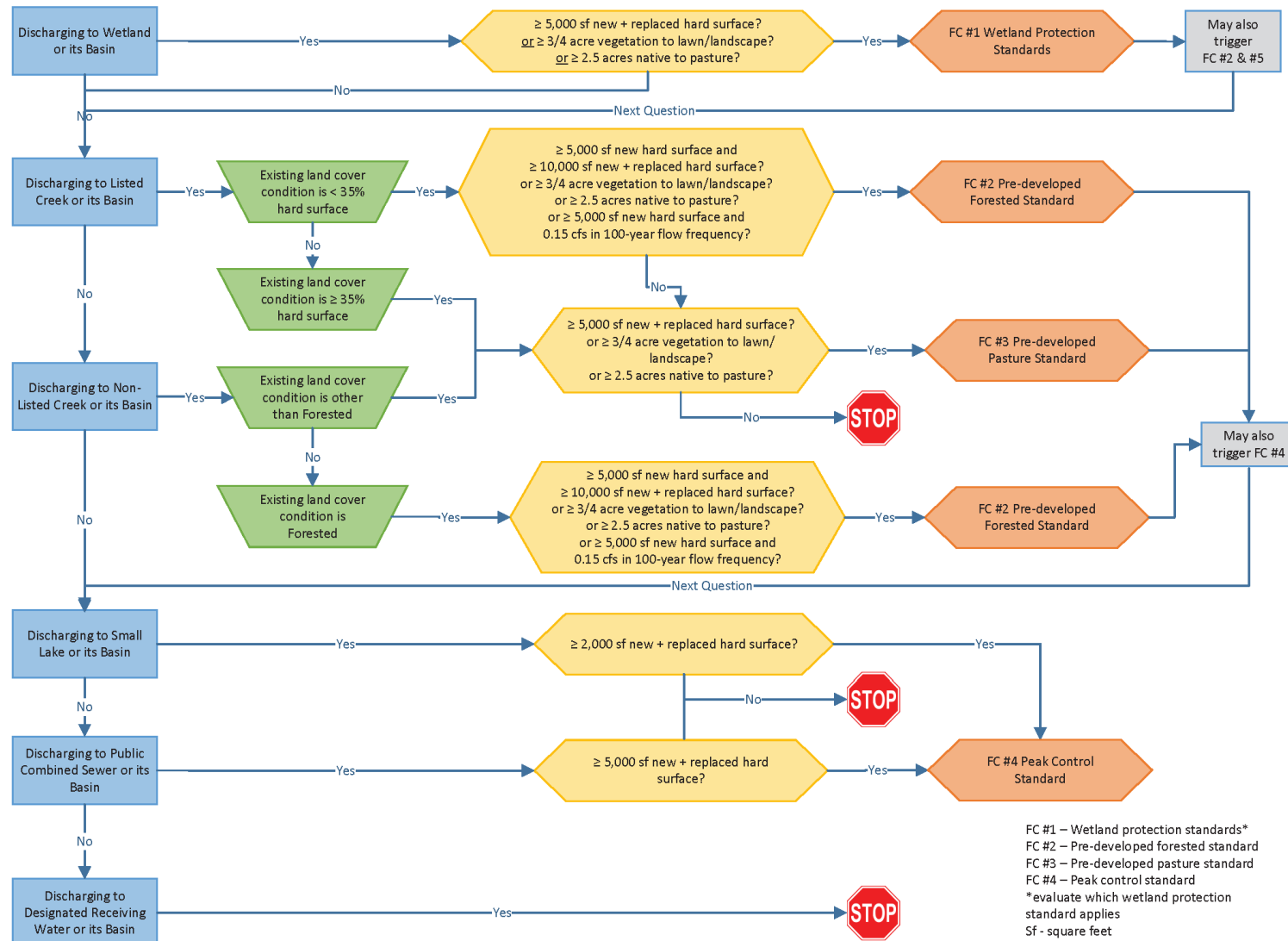

Figure 4.2B. Flow Control Project Minimum Requirements for Parcel-Based Projects (continued).

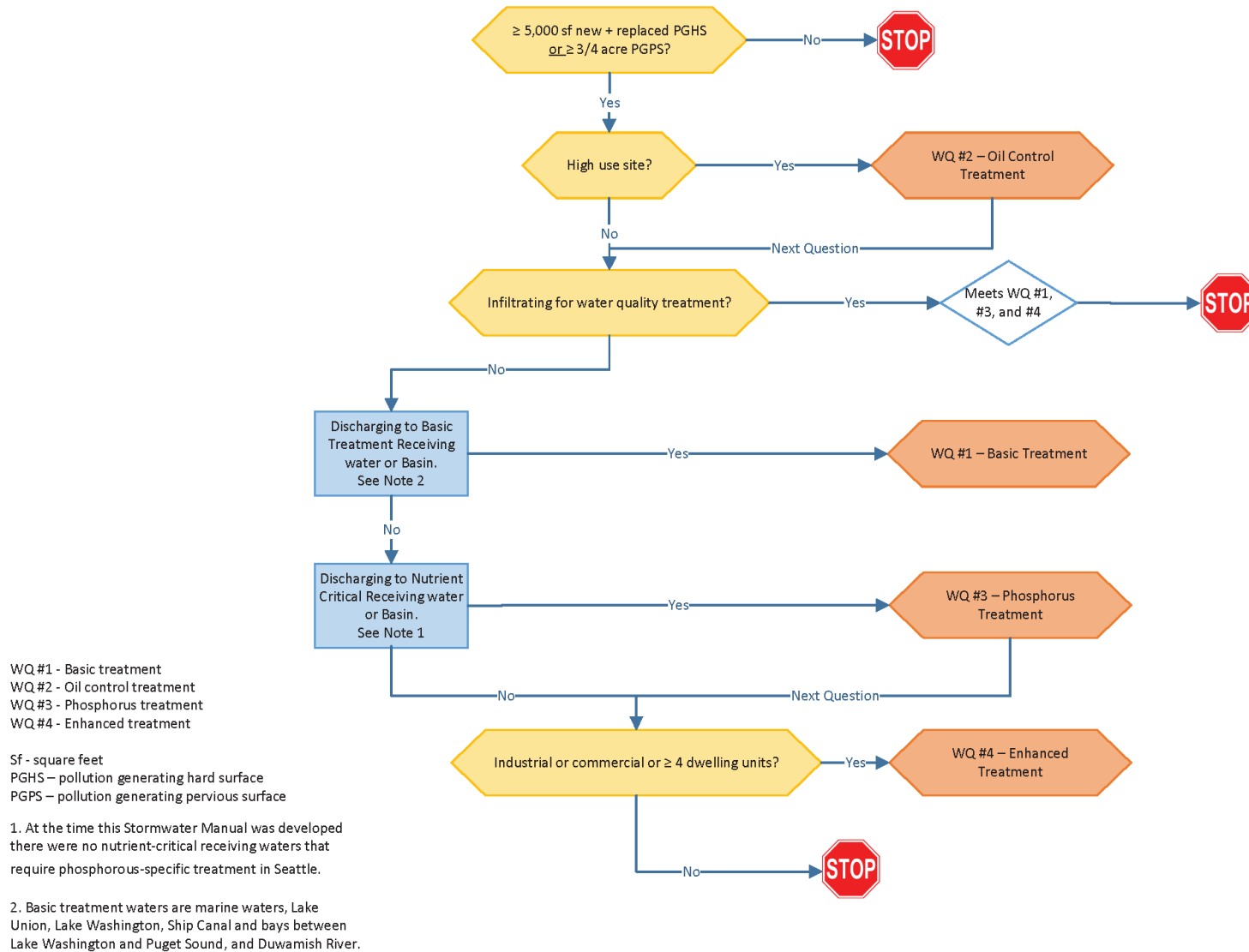

Figure 4.2C. [Water Quality Treatment Project](#) Minimum Requirements for Parcel-Based Projects [\(continued\)](#).

4.4.3. Flow Control

4.4.3.1. Parcel-Based Projects Discharging to Wetlands – Flow Control

Stormwater Code Language	References
<p>SMC 22.805.050.C.1 – Parcel-based projects discharging into a wetland, or to the drainage basin of a wetland, shall:</p> <ol style="list-style-type: none"> a. Comply with Section 22.805.020 (Minimum requirements for all projects), including, but not limited to subsection 22.805.020.E (Protect Wetlands). b. Comply with the minimum requirements for wetland protection contained in subsection 22.805.080.B.1 (Wetland Protection Standards) if: <ol style="list-style-type: none"> 1. The total new plus replaced hard surface is 5,000 square feet or more; or 2. The project converts 3/4 acres or more of vegetation to lawn or landscaped areas, and from the project there is a surface discharge into a natural or constructed conveyance system from the site; or 3. The project converts 2.5 acres or more of native vegetation to pasture, and from the project there is a surface discharge into a natural or constructed conveyance system from the site. 	<ul style="list-style-type: none"> ● Volume 1, Section 2.2.5 – Parcel-Based Project ● Volume 1, Section 3.5 – Protect Wetlands ● Volume 1, Section 5.3.1 (SMC, Section 22.805.080.B.1) – Wetland Protection Standards ● Guide sheets 1 through 3 in the SWMMWW Volume I, Appendix I-CD (Ecology 20192014)

4.4.3.2. Parcel-Based Projects Discharging to Listed Creek Basins – Flow Control

Stormwater Code Language	References
<p>SMC 22.805.050.C.2 – Parcel-based projects discharging into Blue Ridge Creek, Broadview Creek, Discovery Park Creek, Durham Creek, Frink Creek, Golden Gardens Creek, Kiwanis Ravine/Wolfe Creek, Lixon Springs Creek, Madrona Park Creek, Mee-Kwa-Mooks Creek, Mount Baker Park Creek, Puget Creek, Riverview Creek, Schmitz Creek, Taylor Creek, or Washington Park Creek, or to the drainage basin of such creek, shall:</p> <ol style="list-style-type: none"> a. Comply with subsection 22.805.080.B.2 (Pre-developed Forested Standard) if the existing hard surface coverage is less than 35 percent and one or more of the following apply: <ol style="list-style-type: none"> 1. The project adds 5,000 square feet or more of new hard surface and the total new plus replaced hard surface is 10,000 square feet or more; or 2. The project converts 3/4 acres or more of vegetation to lawn or landscaped areas, and from the project there is a surface discharge into a natural or constructed conveyance system from the site; or 3. The project converts 2.5 acres or more of native vegetation to pasture, and from the project there is a surface discharge into a natural or constructed conveyance system from the site; or 4. The project adds 5,000 square feet or more of new hard surface and, through a combination of effective hard surfaces and converted pervious surfaces, causes a 0.15 	<ul style="list-style-type: none"> ● Volume 1, Section 2.2.5 – Parcel-Based Project ● Volume 1, Section 5.3.2 (SMC, Section 22.805.080.B.2) – Pre-developed Forested Standard ● Volume 1, Section 5.3.3 (SMC, Section 22.805.080.B.3) – Pre-developed Pasture Standard ● Volume 3, Section 3.4 – BMP Selection for Flow Control ● Volume 3, Section 4.1 – Sizing Approach

Stormwater Code Language	References
<p><i>cubic feet per second increase in the 100-year recurrence interval flow frequency as estimated using a continuous model approved by the Director.</i></p> <p>b. <i>Comply with subsection 22.805.080.B.3 (Pre-developed Pasture Standard) if the criteria in subsection 22.805.050.C.2.a do not apply and one or more apply:</i></p> <ol style="list-style-type: none"> 1. <i>The total new plus replaced hard surface is 5,000 square feet or more; or</i> 2. <i>The project converts 3/4 acres or more of vegetation to lawn or landscaped areas, and from the project there is a surface discharge into a natural or constructed conveyance system from the site; or</i> 3. <i>The project converts 2.5 acres or more of native vegetation to pasture, and from the project there is a surface discharge into a natural or constructed conveyance system from the site.</i> 	

4.4.3.3. Parcel-Based Projects Discharging to Non-listed Creek Basins – Flow Control

Stormwater Code Language	References
<p>SMC 22.805.050.C.3 – <i>Parcel-based projects discharging into a creek not listed in subsection 22.805.050.C.2, or to the drainage basin of such creek, shall:</i></p> <p>a. <i>Comply with subsection 22.805.080.B.2 (Pre-developed Forested Standard) if the existing land cover is forested and one or more of the following apply:</i></p> <ol style="list-style-type: none"> 1. <i>The project adds 5,000 square feet or more of new hard surface and the total new plus replaced hard surface is 10,000 square feet or more; or</i> 2. <i>The project converts 3/4 acres or more of vegetation to lawn or landscaped areas, and from the project there is a surface discharge into a natural or constructed conveyance system from the site; or</i> 3. <i>The project converts 2.5 acres or more of native vegetation to pasture, and from the project there is a surface discharge into a natural or constructed conveyance system from the site; or</i> 4. <i>The project adds 5,000 square feet or more of new hard surface and, through a combination of effective hard surfaces and converted pervious surfaces, causes a 0.15 cubic feet per second increase in the 100 year recurrence interval flow frequency as estimated using a continuous model approved by the Director.</i> <p>b. <i>Comply with subsection 22.805.080.B.3 (Pre-developed Pasture Standard) if the criteria in subsection 22.805.050.C.3.a do not apply and one or more of the following apply:</i></p> <ol style="list-style-type: none"> 1. <i>The total new plus replaced hard surface is 5,000 square feet or more; or</i> 	<ul style="list-style-type: none"> ● Volume 1, Section 2.2.5 – Parcel-Based Project ● <i>Volume 1, Section 5.3.2 (SMC, Section 22.805.080.B.2) – Pre-developed Forested Standard</i> ● <i>Volume 1, Section 5.3.3 (SMC, Section 22.805.080.B.3) – Pre-developed Pasture Standard</i> ● <i>Volume 3, Section 3.4 – BMP Selection for Flow Control</i> ● <i>Volume 3, Section 4.1 – Sizing Approach</i>

Stormwater Code Language	References
<p>2. The project converts 3/4 acres or more of vegetation to lawn or landscaped areas, and from the project there is a surface discharge into a natural or constructed conveyance system from the site; or</p> <p>3. The project converts 2.5 acres or more of native vegetation to pasture, and from the project there is a surface discharge into a natural or constructed conveyance system from the site.</p>	

4.4.3.4. Parcel-Based Projects Discharging to Small Lake Basins – Flow Control

Stormwater Code Language	References
<p>SMC 22.805.050.C.4 – Parcel-based projects discharging into Bitter Lake, Green Lake, or Haller Lake, or to the drainage basin of such lake, shall comply with subsection 22.805.080.B.5 (Peak Control Standard) if the total new plus replaced hard surface is 2,000 square feet or more.</p>	<ul style="list-style-type: none"> ● Volume 1, Section 2.2.5 – Parcel-Based Project ● Volume 1, Section 5.3.54 (SMC, Section 22.805.080.B.4) – Peak Control Standard ● Volume 3, Section 3.4 – BMP Selection for Flow Control ● Volume 3, Section 4.1 – Sizing Approach

4.4.3.5. Parcel-Based Projects Discharging to Public Combined Sewer – Flow Control

At the time this Manual was developed, there was one public combined sewer basin that was determined to have sufficient capacity to carry existing and anticipated loads. Parcel-based projects are not required to provide peak flow control in this basin. Refer to the SDCI website to determine which basins are included in this category ([www.seattle.gov/sdci/codes/codes-we-enforce-\(a-z\)/stormwater-code](http://www.seattle.gov/sdci/codes/codes-we-enforce-(a-z)/stormwater-code) www.seattle.gov/dpd/codesrules/codes/stormwater).

Stormwater Code Language	References
<p>SMC 22.805.050.C.5 – Unless the Director of SPU has determined that the public combined sewer has sufficient capacity to carry existing and anticipated loads, parcel-based projects discharging into the public combined sewer or its basin shall comply with subsection 22.805.080.B.5 (Peak Control Standard) if the total new plus replaced hard surface is 5,000 square feet or more.</p>	<ul style="list-style-type: none"> ● Volume 1, Section 2.2.5 – Parcel-Based Project ● Volume 1, Section 5.3.54 (SMC, Section 22.805.080.B.4) – Peak Control Standard ● Figure 2.6 – Public Combined Sewer Basins ● Volume 3, Section 3.4 – BMP Selection for Flow Control ● Volume 3, Section 4.1 – Sizing Approach

4.4.3.6. Parcel-Based Projects Discharging to a Capacity-constrained System – Flow Control

Stormwater Code Language	References
<p>SMC 22.805.050.C.6 – Discharges to a Capacity-constrained System. In addition to applicable minimum requirements for flow control in subsection 22.805.050.C.1 through subsection 22.805.050.C.5, parcel-based projects discharging into a capacity-constrained system or its basin shall also comply with subsection 22.805.080.B.5 (Peak Control Standard) if the total new plus replaced hard surface is 2,000 square feet or more unless the downstream system only includes ditches or culverts and the system has been determined to have sufficient capacity as specified in subsection 22.805.020.H (Ensure Sufficient Capacity).</p> <p>SMC 22.801.040 – “Capacity-constrained system” means a drainage system or public combined sewer that the Director of SPU has determined to have inadequate capacity to carry existing and anticipated loads, or a drainage system that includes ditches or culverts.</p>	<ul style="list-style-type: none"> ● Volume 1, Section 2.2.5 – Parcel-Based Project ● Volume 1, Section 4.4.3.1 (SMC, Section 22.805.050.C.1) – Discharges to Wetlands ● Volume 1, Section 4.4.3.2 (SMC, Section 22.805.050.C.2) – Discharges to Listed Creek Basins ● Volume 1, Section 4.4.3.3 (SMC, Section 22.805.050.C.3) – Discharges to Non-listed Creek Basins ● Volume 1, Section 4.4.3.4 (SMC, Section 22.805.050.C.4) – Discharges to Small Lake Basins ● Volume 1, Section 4.4.3.5 (SMC, Section 22.805.050.C.5) – Discharges to Public Combined Sewer ● Volume 1, Section 5.3.54 (SMC, Section 22.805.080.B.54) – Peak Control Standard ● Volume 3, Section 3.4 – BMP Selection for Flow Control ● Volume 3, Section 4.1 – Sizing Approach

4.4.3.7. Parcel-Based Projects Discharging Groundwater – Flow Control

Stormwater Code Language	References
<p>SMC 22.805.050.C.7 – In addition to applicable minimum requirements for flow control in subsection 22.805.050.C.1 through subsection 22.805.050.C.6, parcel-based projects that will permanently discharge groundwater to a public drainage system or to a public combined sewer shall also comply with subsection 22.805.080.B.5 (Peak Control Standard) if the total new plus replaced hard surface is 2,000 square feet or more.</p>	<ul style="list-style-type: none"> ● SMC, Section 22.805.050.C.7 – Discharges from Groundwater ● Volume 1, Section 2.2.5 – Parcel-Based Project ● Volume 1, Section 5.3.5 (SMC, Section 22.805.080.B.5) – Peak Control Standard

Note: If the subsurface drainage for a project (e.g., footing drains, wall drains) extends into a zone containing groundwater, perched or otherwise, evaluation of groundwater discharge is required. If the total estimated groundwater discharge rate from the project site during the wet season is less than 5 gallons per minute for sites less than 1 acre or less than 5 gallons per minute per acre for sites 1 acre or greater, then the groundwater discharge is considered to be de minimis and will not trigger Peak Control Standard. However, if the flow control is

triggered by another condition, the estimated groundwater discharge rate must be considered in the sizing of the flow control BMPs. Estimates of groundwater discharge must be made by a licensed geotechnical engineer or hydrogeologist.

4.4.4. *Water Quality Treatment*

Stormwater Code Language	References
<p><i>SMC 22.805.050.D – Treatment. Parcel-based projects not discharging to the public combined sewer shall comply with the minimum requirements for treatment contained in Section 22.805.090 for flows from the total new plus replaced pollution-generating hard surface and the new plus replaced pollution-generating pervious surface, to the extent allowed by law, if:</i></p> <ol style="list-style-type: none"> <i>1. The total new plus replaced pollution-generating hard surface is 5,000 square feet or more; or</i> <i>2. The total new plus replaced pollution-generating pervious surfaces is 3/4 acres or more, and from the project there is a surface discharge in a natural or constructed conveyance system from the site.</i> 	<ul style="list-style-type: none"> ● SMC, Section 22.805.090 – Minimum Requirements for Treatment ● Volume 1, Section 2.2.5 – Parcel-Based Project ● Volume 1, Section 5.4 (SMC, Section 22.805.090) – Water Quality Treatment ● Volume 3, Section 3.5 – BMP Selection for Water Quality Treatment ● Volume 3, Section 4.1 – Sizing Approach

4.5. Reduced Requirements for Certain Land-Disturbing Activities

Certain land-disturbing activities are not required to comply with some of the minimum requirements. These activities are summarized below for utility projects ([Section 4.5.1](#)), pavement maintenance projects ([Section 4.5.2](#)), remediation projects ([Section 4.5.3](#)), and retrofit projects ([Section 4.5.4](#)).

4.5.1. *Utility Projects*

Applicable utility projects are described in SMC, Section 22.800.040.A.2.a. Note that the installation of side sewers, service drains, and underdrains require a Side Sewer Permit per SMC, Section 21.16.070 (Permit And Fee Required For Connection And Repairs).

Installation of a new fuel tank is not considered a utility project. Projects that include fuel dispensing equipment, installation of underdrains for groundwater collection, parking or driveway areas for utility maintenance or operation, buildings for utility maintenance or operation, or pavement replacement or repair beyond the extent required for the utility maintenance, repair or installation are not considered a utility project.

Stormwater Code Language	References
<p>SMC 22.800.040.A.2.a – Maintenance, repair, or installation of underground or overhead utility facilities, such as, but not limited to, pipes, conduits and vaults, and that includes replacing the ground surface with in-kind material or materials with similar runoff characteristics are not required to comply with Section 22.805.070 (Minimum Requirements for On-site Stormwater Management), Section 22.805.080 (Minimum Requirements for Flow Control), or Section 22.805.090 (Minimum Requirements for Treatment), except as modified as follows:</p> <ol style="list-style-type: none"> 1. Installation of underground or overhead utility facilities that are integral with and contiguous to a road-related project shall comply with Section 22.805.060 (Minimum Requirements for Roadway Projects). 	<ul style="list-style-type: none"> • Volume 1, Chapter 35 (SMC, Section 22.805.020) – Minimum Requirements for All Projects

4.5.2. *Pavement Maintenance Projects*

Applicable pavement maintenance projects are described in SMC, Section 22.800.040.A.2.b.

Stormwater Code Language	References
<p>SMC 22.800.040.A.2.b – Pavement maintenance practices limited to the following activities are not required to comply with Section 22.805.060 (Minimum Requirements for Roadway Projects), Section 22.805.070 (Minimum Requirements for On-site Stormwater Management), Section 22.805.080 (Minimum Requirements for Flow Control), or Section 22.805.090 (Minimum Requirements for Treatment):</p> <ol style="list-style-type: none"> 1. Pothole and square cut patching; 2. Overlaying existing asphalt or concrete or brick pavement with asphalt or concrete without expanding the area of coverage; 3. Shoulder grading; 4. Reshaping or regrading drainage ditches; 	<ul style="list-style-type: none"> • Volume 1, Chapter 35 (SMC, Section 22.805.020) – Minimum Requirements for All Projects

5. Crack sealing; and	
6. Vegetation maintenance.	

4.5.3. Remediation Projects

Applicable remediation projects are described in SMC, [Section 22.800.040.A.2.c.](#)

<u>Stormwater Code Language</u>	<u>References</u>
SMC 22.800.040.A.2.c – <i>Land disturbing activity that includes replacing the ground surface with in-kind material or with materials having equivalent runoff characteristics and is associated solely with soil remediation or tank removal for the purpose of removing contaminants and pollutants and not associated with other development is not required to comply with subsections 22.805.050.A and 22.805.060.A (Soil Amendment), Section 22.805.070 (Minimum Requirements for On-site Stormwater Management), or Section 22.805.080 (Minimum Requirements for Flow Control). Projects that include any development in addition to soil remediation or tank removal replaced with in-kind material or with materials having equivalent runoff characteristics are not exempt.</i>	<ul style="list-style-type: none"> • Volume 1, Chapter 3 (SMC, Section 22.805.020) – Minimum Requirements for All Projects

4.5.4. Retrofit Projects

Applicable retrofit projects are described in SMC, [Section 22.800.040.A.2.d.](#)

<u>Stormwater Code Language</u>	<u>References</u>
SMC 22.800.040.A.2.d – <i>Drainage control facilities that are part of a public retrofit project installed to meet Appendix 12 to the City’s municipal stormwater NPDES permit or for combined sewer control, or other voluntary retrofit project, are not required to comply with Section 22.805.070 (Minimum Requirements for On-site Stormwater Management), Section 22.805.080 (Minimum Requirements for Flow Control), or Section 22.805.090 (Minimum Requirements for Treatment). This exemption does not include land disturbing activities or hard surfaces that are not integral to or are in addition to the drainage control facilities described above, or installation of drainage control facilities that are otherwise required to meet this subtitle.</i>	<ul style="list-style-type: none"> • Volume 1, Chapter 3 (SMC, Section 22.805.020) – Minimum Requirements for All Projects

[Examples of projects that meet the criteria for retrofit projects include projects whose sole purpose is to reduce runoff, improve water quality, reduce flooding, reduce sanitary sewer overflows \(SSOs\), or combined sewer overflows \(CSOs\) and are not otherwise installed as a requirement of meeting the requirements of SMC, Section 22.805. Qualifying project types that address stormwater runoff include:](#)

1. [Installation of flow control facilities \(e.g., detention tanks, pump stations\)](#)
2. [Installation of water quality treatment facilities \(e.g., water quality treatment pond\)](#)
3. [Installation of green stormwater infrastructure \(e.g., natural drainage systems, bioretention cells\)](#)
4. [Retrofit of existing drainage and wastewater infrastructure](#)

- [5. Restoration of riparian buffer](#)
- [6. Restoration of forest cover](#)
- [7. Floodplain reconnection project](#)
- [8. Removal of impervious or hard surfaces not associated with other development](#)
- [9. Other actions to address stormwater runoff and water quality treatment](#)

4.6. WSDOT Projects

Applicable WSDOT projects are described in SMC, Section 22.800.040.A.6.

Stormwater Code Language	References
<p>SMC 22.800.040.A.6 – <i>With respect to all state highway right-of-way under Washington State Department of Transportation (WSDOT) control within the jurisdiction of The City of Seattle, WSDOT shall use the current, approved Highway Runoff Manual (HRM) for its existing and new facilities and rights-of-way, as addressed in WAC 173-270-030(1) and (2). Exceptions to this exemption, where more stringent stormwater management requirements apply, are addressed in WAC 173-270-030(3)(b) and (c).</i></p> <ol style="list-style-type: none"> a. <i>When a state highway is located in the jurisdiction of a local government that is required by Ecology to use more stringent standards to protect the quality of receiving waters, WSDOT shall comply with the same standards to promote uniform stormwater management.</i> b. <i>WSDOT shall comply with standards identified in watershed action plans for WSDOT rights-of-way, to the extent required by state law.</i> c. <i>Other instances where more stringent local stormwater standards apply are projects subject to tribal government standards or to the stormwater management-related permit conditions imposed under Chapter 25.09 to protect environmentally critical areas and their buffers (under the Growth Management Act), an NPDES permit, or shoreline master programs (under the Shoreline Management Act). In addition, WSDOT shall comply with local jurisdiction stormwater standards when WSDOT elects, and is granted permission, to discharge stormwater runoff into a municipality's drainage system or combined sewer system.</i> 	<ul style="list-style-type: none"> ● Volume 1, Section 4.3 (SMC, Section 22.805.060) – Minimum Requirements for Roadway Projects ● WSDOT Highway Runoff Manual ● WAC, Sections 173-270-030(1) and (2) – Best Management Practices – Approved Manual Required and Amendments to Manual ● WAC, Sections 173-270-030(3)(b) and (c) – More Stringent Standards ● SMC, Chapter 25.09 – Environmentally Critical Areas

4.6.4.7. Special Circumstances

Some projects do not closely fit defined project types or have complicating elements. and, therefore, These projects require a case-by-case review (no review of special circumstances sets a precedent) to determine the applicable minimum requirements. These projects shall first go through a pre-permit review process to assist the proponent in identifying the specific minimum requirements to be applied. Project requirements will be based on requirements for roadway projects (refer to Section 4.3) or parcel-based projects (refer to Section 4.4) or a combination, in addition to minimum requirements for all projects (refer to Chapter 3).

The following list is not comprehensive, but gives the proponent an indication of the complexity of the special circumstances. Examples of special circumstances projects include:

- Bridges or tunnels
- Construction over water
- Closed-contour basins
- Draining into more than one basin with conflicting requirements
- Multiple blocks or a subdivision
- Railroads
- Rail stations in public right-of-way
- Work performed in more than one jurisdiction

Projects that propose to develop multiple blocks or a subdivision have the potential for greater impacts to the existing drainage system or public combined sewer. These projects may be required to conduct a more comprehensive downstream analysis examining a larger range of flow and discharge conditions to demonstrate that the project meets the requirement to ensure sufficient capacity (SMC, Section 22.805.020H) and will not cause a significant adverse impact to receiving waters or up-gradient or down-gradient properties (SMC, Section 22.805.020A).

Similarly, projects that discharge to closed-contour basins may be required to demonstrate the project will not cause a significant adverse impact to down-gradient properties (SMC, Section 22.805.020H) and increase either the frequency or severity of flooding, including for peak flows with a 1 percent annual probability.

Projects that discharge to multiple drainage basins will be analyzed separately by drainage basin. To determine which minimum requirements apply and which part of the drainage system or public combined sewer will be analyzed to ensure sufficient capacity, the proponent shall prepare exhibits showing the land disturbing activity anticipated for each receiving water and drainage basin and downstream drainage system. Refer to Section 2.3.

The Director of SPU may determine that subbasins within the public combined sewer system or designated receiving waters are sufficiently distinct and separated to be analyzed independently and as separate areas. Discharges to each of the small lake basins will be analyzed independently and are considered separate areas.

Discharges to each creek basin will be analyzed independently and are considered separate areas. In addition, discharges to distinct branches of a creek, or where the two points discharge to a single creek branch are more than 1/4 mile apart, will be analyzed independently and are considered separate areas.

If a project requires compliance with more than one flow control standard (e.g., the Peak Control Standard and the Pre-Developed Pasture Standard), the facility shall be sized to meet all standards unless otherwise allowed using the Pre-sized Approach (refer to *Volume 3, Section 4.1.2*).

CHAPTER 5 – MINIMUM REQUIREMENT STANDARDS

This chapter summarizes the standards related to the following minimum requirements:

- Soil amendment (*Section 5.1*)
- On-site stormwater management (*Section 5.2*)
- Flow control (*Section 5.3*)
- Water quality treatment (*Section 5.4*)

Excerpts from the Stormwater Code (in *italics*) are presented below in the first column in the code reference box in each section. The second column in the code reference box provides applicable references.

5.1. Soil Amendment

Projects triggering this minimum requirement shall retain and protect undisturbed soil in areas not being developed and, prior to completion of the project, amend all new, replaced, and disturbed topsoil with organic matter. This requirement applies to the four primary project types (single-family residential, trail and sidewalk, parcel-based, and roadway projects). General soil amendment requirements included in SMC, Section 22.805.030, Section 22.805.040, Section 22.805.050, and Section 22.805.060 are summarized below.

Stormwater Code Language	References
<p><i>SMC, Section 22.805.030.A; SMC, Section 22.805.040.A; SMC, Section 22.805.060.A – Retain and protect undisturbed soil in areas not being developed, and prior to completion of the project, amend all new, replaced, and disturbed topsoil (including construction lay-down areas) with organic matter to the extent required by and in compliance with the rules promulgated by the Director.</i></p>	<ul style="list-style-type: none"> ● <i>Volume 3, Section 5.1 – Soil Amendment BMP</i>

5.2. On-site Stormwater Management

Projects triggering this minimum requirement shall evaluate on-site stormwater management to meet the applicable design requirements for the specific project type and discharge location. On-site stormwater management includes BMPs that can be used to meet flow control and water quality treatment requirements. General on-site stormwater management requirements included in SMC, Section 22.805.070 are summarized below. Refer to *Section 5.2.1* and *5.2.2* for the On-site Performance Standard and the On-site List Approach.

Stormwater Code Language	References
<p><i>SMC, Section 22.805.070 –</i></p> <p><i>A. Applicability. The requirements of this subsection 22.805.070 apply as required in Section 22.805.030 to Section 22.805.060.</i></p> <p><i>B. Requirements. On-site stormwater management shall be installed to the extent allowed by law and maintained in compliance with the rules promulgated by the Director to receive flows from that portion of the site being developed and shall:</i></p> <p><i>1. Comply with either:</i></p> <p><i>a. Subsection 22.805.070.C (On-site Performance Standard); or</i></p> <p><i>b. Subsection 22.805.070.D (On-site Lists).</i></p>	<ul style="list-style-type: none"> ● <i>Volume 1, Section 4.1 – Single Family Residential Projects</i> ● <i>Volume 1, Section 4.2 – Trail and Sidewalk Projects</i> ● <i>Volume 1, Section 4.3.2 – On-site Stormwater Management for Roadway Projects</i> ● <i>Volume 1, Section 4.4.2 – On-site Stormwater Management for Parcel-Based Projects</i> ● <i>Volume 1, Section 5.2.1 (SMC, Section 22.805.070.C) – On-site Performance Standard</i> ● <i>Volume 1, Section 5.2.2 (SMC, Section 22.805.070.D) – On-site Lists</i> ● <i>Volume 3, Section 3.3 – BMP Selection for On-site Stormwater Management</i> ● <i>Volume 3, Section 4.1 – Sizing Approach</i> ● <i>Volume 3, Section 5.1 – Soil Amendment BMP</i> ● <i>Volume 3, Section 5.2 – Tree Planting and Retention</i> ● <i>Appendix C – On-site Stormwater Management Infeasibility Criteria</i>

Projects triggering this minimum requirement shall evaluate on-site stormwater management to meet the applicable design requirements for the given project type, size, and discharge location as summarized in *Chapter 2*. Two approaches that can be used for evaluating Minimum Requirements for On-site Stormwater Management include the following:

- On-site Performance Standard per *Section 5.2.1*, or
- On-site Lists per *Section 5.2.2*.

5.2.1. On-site Performance Standard

Stormwater Code Language	References
<p><i>SMC 22.805.070.C –</i></p> <ol style="list-style-type: none"> 1. <i>If the existing hard surface coverage is less than 35 percent and the project discharges to a listed creek, or to the drainage basin of such creek:</i> <ol style="list-style-type: none"> a. <i>The post-development discharge durations shall match the discharge durations of a pre-developed forested condition for the range of pre-developed discharge rates from 8 percent of the 2-year peak flow to 50 percent of the 2-year peak flow.</i> 2. <i>For all other projects:</i> <ol style="list-style-type: none"> a. <i>The post-development discharge durations shall match the discharge durations of a pre-developed pasture condition for the range of pre-developed discharge rates between the 1 percent and 10 percent exceedance values.</i> 	<ul style="list-style-type: none"> • <i>Volume 3, Section 3.3.2 – On-site Performance Standard Approach</i> • <i>Volume 3, Section 4.1.3 – Modeling Approach</i> • <i>Appendix F – Hydrologic Analysis and Design</i>

5.2.2. On-site Lists

Stormwater Code Language	References
<p><i>SMC 22.805.070.D –</i></p> <ol style="list-style-type: none"> 1. <i>For each project surface, follow the appropriate project table in subsection 22.805.070.D.2 to subsection 22.805.070.D.5 to evaluate on-site BMPs shown for that type of surface, by category. The project tables apply to roofs and other hard (non-roof) surfaces. All on-site BMPs used must comply with the rules promulgated by the Director. For each surface, consider all of the applicable on-site BMPs in the first category. Use any that is considered feasible. If none is feasible for that surface, move on to each successive category and repeat the selection process as necessary. Once one on-site BMP is used for a surface, no other on-site BMP is necessary for that surface. If no BMP in the appropriate categories is feasible, then no further evaluation is required for that surface under this subsection 22.805.70.D.1. Feasibility shall be determined by evaluation against:</i> <ol style="list-style-type: none"> a. <i>Design criteria, minimum size, limitations, and infeasibility criteria identified for each BMP in this subsection and the rules promulgated by the Director; and</i> b. <i>Competing Needs: Subsection 22.805.070.D (On-site Lists) can be superseded or reduced by the Director if the installation of the BMPs is in conflict with:</i> <ol style="list-style-type: none"> 1) <i>Any of the following federal or state laws, rules, and standards, as may be amended or superseded: Historic Preservation and Archaeology Laws identified in subsection 22.805.070.E (Historic Preservation and Archaeology Laws), Federal Superfund or Washington State Model Toxics Control Act, Federal Aviation Administration requirements for airports, the Americans with Disabilities Act, and related rules and standards; or</i> 	<ul style="list-style-type: none"> • <i>Volume 3, Section 3.3.1 – On-site List Approach</i> • <i>Volume 3, Section 4.1.1 – On-site List Approach</i> • <i>Appendix C – On-site Stormwater Management Infeasibility Criteria</i>

Stormwater Code Language	References
<p>2) <i>Special zoning district design criteria adopted and being implemented pursuant to a community planning process. Special zoning districts include, for example, historic and preservation districts, pedestrian zone overlays, station area overlays, special review districts, multifamily residential zones, urban centers and urban villages, and master planned communities. Specific criteria in these areas include, but are not limited to, minimum Floor Area Ratio standards; zero lot line development; usable open space requirements; minimum sidewalk width and required bicycle facilities; alley, loading, and access requirements; pitched roof standards; and street-level development standards for modulation and projections; or</i></p> <p>3) <i>Public health and safety standards; or</i></p> <p>4) <i>Transportation regulations to maintain the option for future expansion or multi-modal use of public rights-of-way; or</i></p> <p>5) <i>Chapter 15.43 (Tree and Vegetation Management in Public Places); Chapter 25.09 (Regulations for Environmentally Critical Areas); Chapter 25.11 (Tree Protection); and Chapter 23.60A (Standards for Vegetation in the Shoreline Master Plan).</i></p> <p>2. <i>For single-family residential projects, Table A for 22.805.070 applies.</i></p> <p>3. <i>For trail and sidewalk projects, Table B for 22.805.070 applies.</i></p> <p>4. <i>For parcel-based projects, Table C for 22.805.070 applies.</i></p> <p>5. <i>For roadway projects, Table D for 22.805.070 applies.</i></p>	<ul style="list-style-type: none"> ● <i>Volume 3, Section 3.3.1 – On-site List Approach</i> ● <i>Volume 3, Section 4.1.1 – On-site List Approach</i> ● <i>Appendix C – On-site Stormwater Management Infeasibility Criteria</i>

5.2.2.1. *Single-Family Residential Projects*

Table A for 22.805.070. On-site List for Single-Family Residential Projects.

Category	BMPs	All Discharge Locations
1	Full Dispersion	R, S
	Infiltration Trenches	R, S ^d
	Drywells	R, S ^d
2	Rain Gardens ^a	R, S
	Infiltrating Bioretention	R, S
	Rainwater Harvesting – Category 2 Sizing	X ^b
	Permeable Pavement Facilities	R, S
	Permeable Pavement Surfaces	S
	Sidewalk/Trail Compost-Amended Strip	S
3	Sheet Flow Dispersion	R, S
	Concentrated Flow Dispersion	S
	Splashblock Downspout Dispersion	R
	Trench Downspout Dispersion	R
4	Non-infiltrating Bioretention	R, S
	Rainwater Harvesting – Category 4 Sizing	X ^c
	Vegetated Roofs	X
5	Single-family Residential Cisterns	R
	Perforated Stub-out Connections	R
	Trees	S

Note that subsection 22.805.070.D.1 requires consideration of all on-site BMPs in a category for feasibility before moving on to each successive category as necessary. Within a category, BMPs may be considered in any order.

BMPs – Best Management Practices

R = Evaluation is required for all roof runoff from Single-family residential projects.

S = Evaluation is required for all other hard (non-roof) surfaces of Single-family residential projects, unless otherwise noted below .

X = Evaluation is not required but is allowed.

^a Installation is only allowed for projects with less than 5,000 square feet of hard surface infiltrating on the project site.

^b Category 2 rainwater harvesting shall be sized to meet the on-site performance standard, subsection 22.805.070.C.

^c Category 4 rainwater harvesting shall be sized to reduce the runoff volume by 25 percent or more on an annual average basis.

^d Evaluation of other hard (non-roof) surfaces is not required but is allowed.

5.2.2.2. Trail and Sidewalk Projects

Table B for 22.805.070. On-site List for Trail and Sidewalk Projects.

Category	BMPs	Projects Discharging to a Receiving Water Not Designated by Section 22.801.050, or its Basin [creek, small lake basin, or wetland]	Projects Discharging to a Public Combined Sewer or Capacity Constrained System, ^c or its Basin	Projects Discharging to a Designated Receiving Water, or its Basin
1	Full Dispersion	S	S	S
2	Rain Gardens	S	S	X
	Permeable Pavement Facilities	X	X ^a	X ^{a,b}
	Permeable Pavement Surfaces	S	S ^a	X ^{a,b}
	Sidewalk/Trail Compost-Amended Strip	S	S	X
3	Sheet Flow Dispersion	S	S	S
	Concentrated Flow Dispersion	S	S	S
4	Trees	S	S	S

Note that subsection 22.805.070.D.1 requires consideration of all on-site BMPs in a category for feasibility before moving on to each successive category as necessary. Within a category, BMPs may be considered in any order.

BMPs – Best Management Practices

S = Evaluation is required for all surfaces of trail or sidewalk projects.

X = Evaluation is not required for trail or sidewalk projects.

^a Minimum permeable pavement area allowed in right-of-way is 2,000 square feet of pavement within the project site.

^b Installation is not allowed in the right-of-way if new plus replaced pollution-generating hard surface area is less than 2,000 square feet of pavement within the project site.

^c Does not include any project discharging to a receiving water not designated by Section 22.801.050 (e.g., wetlands, creeks, and small lakes), or its basin, even if the project discharges to a capacity-constrained system or its basin.

5.2.2.3. Parcel-Based Projects

Table C for 22.805.070. On-site List for Parcel-Based Projects.

Category	BMPs	Projects Discharging to a Receiving Water Not Designated by Section 22.801.050 [creek, small lake basin, or wetland], a Public Combined Sewer or Capacity Constrained System, or its Basin	Projects Discharging to a Designated Receiving Water or its Basin
1	Full Dispersion	R, S	R, S
	Infiltration Trenches	R, S ^g	R, S ^g
	Drywells	R, S ^g	R, S ^g
2	Rain Gardens	R ^a , S ^a	R ^a , S ^a
	Infiltrating Bioretention	R, S	R, S
	Rainwater Harvesting – Category 2 Sizing	X ^e	X ^e
	Permeable Pavement Facilities	R, S	R, S
	Permeable Pavement Surfaces	S	S
	Sidewalk/Trail Compost-Amended Strip	S	S
3	Sheet Flow Dispersion	R, S	R, S
	Concentrated Flow Dispersion	S	S
	Splashblock Downspout Dispersion	R	R
	Trench Downspout Dispersion	R	R
4	Non-infiltrating Bioretention	R ^d , S ^d	R ^d , S ^d
	Rainwater Harvesting – Category 4 Sizing	R ^{b,f}	X ^f
	Vegetated Roofs	R ^c	X
5	Perforated Stub-out Connections	R	R
	Trees	S	S

Note that subsection 22.805.070.D.1 requires consideration of all on-site BMPs in a category for feasibility before moving on to each successive category as necessary. Within a category, BMPs may be considered in any order.

BMPs – Best Management Practices

R = Evaluation is required for roof runoff from parcel-based projects, unless otherwise noted below.

S = Evaluation is required for all other hard (non-roof) surfaces of parcel-based projects, unless otherwise noted below.

X = Evaluation is not required but is allowed.

^a Rain gardens cannot be used to meet Section 22.805.080 (Minimum Requirements for Flow Control) or Section 22.805.090 (Minimum Requirements for Treatment) or for areas of 5,000 square feet or more of hard surface infiltrating on the project site.

^b Evaluation is not required for projects with less than 20,000 square feet of new plus replaced rooftop surface.

^c Evaluation is not required for projects with less than 5,000 square feet of new plus replaced rooftop surface.

^d Water quality treatment BMPs sized to meet Section 22.805.090 (Minimum Requirements for Treatment) may be installed in lieu of non-infiltrating bioretention unless the project discharges to a public combined sewer basin.

^e Category 2 rainwater harvesting shall be sized to meet the on-site performance standard, subsection 22.805.070.C.

^f Category 4 rainwater harvesting shall be sized to reduce the runoff volume by 25 percent or more on an annual average basis.

^g Evaluation of other hard (non-roof) surfaces is not required but is allowed.

5.2.2.4. Roadway Projects

Table D for 22.805.070. On-site List for Roadway Projects.

Category	BMPs	Projects Discharging to a Receiving Water Not Designated by Section 22.801.050, or its Basin [creek, small lake basin, or wetland]	Projects Discharging to a Public Combined Sewer or Capacity Constrained System, ^g or its Basin	Projects Discharging to a Designated Receiving Water Basin
1	Full Dispersion	S	S	S
2	Rain Gardens	S ^a	S ^a	S ^a
	Infiltrating Bioretention	S	S ^b	S ^{b,c}
	Permeable Pavement Facilities	X ^d	X ^{e,f}	X ^{c,e,f}
	Permeable Pavement Surfaces	S ^d	S ^{e,f}	X ^{c,e,f}
	Sidewalk/Trail Compost-Amended Strip	S ^e	S ^e	S ^e
3	Sheet Flow Dispersion	S	S	S
	Concentrated Flow Dispersion	S	S	S
4	Trees	S	S	S

Note that subsection 22.805.070.D.1 requires consideration of all on-site BMPs in a category for feasibility before moving on to each successive category as necessary. Within a category, BMPs may be considered in any order.

BMPs – Best Management Practices

PGIS – Pollution generating impervious surface

S = Evaluation is required for all surfaces of Roadway Projects.

X = Evaluation is not required for Roadway Projects, but is allowed.

- ^a Rain gardens cannot be used to meet Section 22.805.080 (Minimum Requirements for Flow Control) or Section 22.805.090 (Minimum Requirements for Treatment) or for areas of 5,000 square feet or more of hard surface infiltrating on the project site.
- ^b Minimum bioretention cell size top area in right-of-way is 500 square feet (including pre-settling area). Evaluation is only required and installation only allowed when contributing area is sufficient to warrant minimum bioretention cell size in right-of-way.
- ^c Evaluation is not required, and installation is not allowed, if new plus replaced pollution-generating hard surface is less than 2,000 square feet.
- ^d Evaluation of roadway surfaces is not required, and installation is not allowed, if roadway is an arterial street/collector.
- ^e Evaluation of roadway surfaces, including alleys, is not required and installation is not allowed.
- ^f Minimum permeable pavement area allowed in right-of-way is 2,000 sf of pavement within the project site.
- ^g **Does not** include any project discharging to a receiving water not designated by Section 22.801.050 (e.g., wetlands, creeks, and small lakes), or its basin, even if the project discharges to a capacity-constrained system or its basin.

5.3. Flow Control

Projects triggering this minimum requirement shall install flow control BMPs meeting the applicable design requirements for the given project type, size, and discharge location as summarized in *Chapter 2*. General flow control requirements included in SMC, Section 22.805.080 are summarized below. Refer to *Section 5.3.1* through [5.3.55-3-4](#) for specific flow control standards for wetland protection, pre-developed forested, pre-developed pasture, [existing condition](#), and peak control.

Stormwater Code Language	References
<p><i>SMC, Section 22.805.080 –</i></p> <p><i>A. Applicability: The requirements of this subsection apply to the extent required in Section 22.805.050 to Section 22.805.060.</i></p> <p><i>B. Requirements. Flow control facilities shall be installed to the extent allowed by law and maintained pursuant to rules promulgated by the Director to receive flows from that portion of the site being developed. Post-development discharge determination must include flows from dewatering activities. All projects shall use on-site BMPs identified in Section 22.805.070.D to the maximum extent feasible to meet the minimum requirements. Flow control facilities that receive flows from less than that portion of the site being developed may be installed if the total new plus replaced impervious surface is less than 10,000 square feet, the project site uses only on-site BMPs to meet the requirement, and the on-site BMPs provide substantially equivalent environmental protection as facilities not using on-site BMPs that receive flows from all of the portion of the site being developed.</i></p>	<ul style="list-style-type: none"> ● <i>Volume 1, Section 4.3.3 – Minimum Requirements for Flow Control for Roadway Projects</i> ● <i>Volume 1, Section 4.4.3 – Minimum Requirements for Flow Control for Parcel-Based Projects</i> ● <i>Volume 1, Section 5.3.1 – Wetland Protection Standards</i>s ● <i>Volume 1, Section 5.3.2 – Pre-developed Forested Standard</i> ● <i>Volume 1, Section 5.3.3 – Pre-developed Pasture Standard</i> ● Volume 1, Section 5.3.4 – Existing Condition Standard ● <i>Volume 1, Section 5.3.55-3-4 – Peak Control Standard</i>

Note:

- If a project requires compliance with the Peak Control Standard and either the Pre-developed Forested or Pre-developed Pasture Standard apply, the [BMP facility](#) shall be sized to [meet both standards unless otherwise allowed using the Pre-sized Approach \(refer to Volume 3, Section 4.1.2\) the standard that results in the largest facility \(i.e., to meet the more stringent of the requirements\)](#).
- Projects with 35 percent or greater existing hard surface may manage a smaller portion of the project's new and replaced hard surface area to meet flow control requirements if only On-site BMPs are employed.
 - Specifically, if flow control is required and only On-site BMPs are used, the hard surface area requiring management may be reduced by up to 2,000 square feet if On-site BMPs are utilized to the maximum extent feasible.
 - ~~If an infiltration basin or any detention BMPs are used, all of the new and replaced hard surface area shall be managed except as detailed in Volume 3, Section 4.2.2.3.~~
- When off-site flows cannot feasibly bypass proposed flow control BMPs, the flow control BMPs shall be modeled and sized to handle the combined total flow (refer to *Volume 3, Section 4.2.2*).

- Flow control BMPs are not required if the site fully infiltrates all flows, as determined by a licensed civil engineer using an approved continuous runoff model for the 158-year simulation period (refer to *Appendix F*).

Excerpts from the Stormwater Code (in italics) are presented below in the first column in each section. The second column in each section provides applicable references.

5.3.1. *Wetland Protection Standards*

Stormwater Code Language	References
<p><i>SMC 22.805.080.B.1 – Wetland Protection Standards. Protect the functions and values of wetlands and their buffers from all projects discharging stormwater directly or indirectly to them. The hydrologic conditions, vegetative community, and substrate characteristics of the wetlands shall be protected, and impacts caused by changes in water flows and pollutants shall be prevented. The introduction of sediment, heat and other pollutants and contaminants into wetlands shall be minimized through the selection, design, installation, and maintenance of temporary and permanent controls.</i></p> <p><i>Before authorizing new discharges to a wetland, alternative discharge locations shall be evaluated and infiltration options outside the wetland shall be maximized unless doing so will adversely impact the functions and values of the affected wetlands. If one or more of the flow control requirements contained in subsections 22.805.080.B.2 through 22.805.080.B.4 also applies to the project, an analysis shall be conducted to ensure that the functions and values of the affected wetland are protected before implementing these flow control requirements.</i></p> <p><i>Notwithstanding any provision in this subtitle, no net loss of wetland functions or values shall result from actions regulated by this subtitle.</i></p> <p><i>Refer to the Washington State Wetland Rating System for Western Washington: 2014 Update (Hruby, 2014) to determine the category, characteristics, and habitat score of the wetland. Wetland classification shall be determined by a wetland professional per rules promulgated under subsection 25.09.330.C (Regulations for Environmentally Critical Areas).</i></p> <p><i>a. Comply with subsection 22.805.080.B.1.c (Wetland Protection Standard—Method 1: Monitoring and Wetland Stage Modeling) if the following applies:</i></p> <ol style="list-style-type: none"> <i>1) The project discharges to a Category I or II depressional or riverine impounding wetland; and</i> <i>2) The project owner has legal access to the entire wetland for purposes of conducting monitoring in the wetland.</i> <p><i>b. Comply with subsection 22.805.080.B.1.d (Wetland Protection Standard—Method 2: Site Discharge Modeling) if the criteria in subsection 22.805.080.B.1.a do not apply and one or more of the following applies (or applicability is unknown):</i></p> <ol style="list-style-type: none"> <i>1) The wetland is Class I or II and does not meet the requirements of subsection 22.805.080.B.1.a.</i> <i>2) The wetland is Class III or IV and:</i> <ol style="list-style-type: none"> <i>a) Has a habitat score greater than 5;</i> <i>b) Is interdunal and has special characteristics;</i> 	<ul style="list-style-type: none"> • SMC, Section 22.805.080.B.2 – Pre-developed Forested Standard • SMC, Section 22.805.080.B.3 – Pre-developed Pasture Standard • SMC, Section 22.805.080.B.54 – Peak Control Standard • Volume 1, Section 3.7 – Protect Wetlands • Guide sheets 1 through 3 in the SWMMWW Volume I, Appendix I-CD (Ecology 20192014)

Stormwater Code Language	References
<p>c) <i>Provides habitat for rare, threatened, endangered, or sensitive species; or</i></p> <p>d) <i>Contains breeding population of any native amphibian. Per Ecology’s guidance, wetlands with permanent or seasonal ponding or inundation are assumed to have breeding population of native amphibian.</i></p> <p>c. <i>Wetland Protection Standard—Method 1: Monitoring and Wetland Stage Modeling. Comply with I-C.4, Wetland Hydroperiod Protection, presented in Appendix I-C of Ecology’s Stormwater Management Manual for Western Washington (Ecology 2019).</i></p> <p><i>Projects triggering Method 1 shall refer to I-C-5, Wetland Hydroperiod Data Collection and Evaluation Procedures, presented in Appendix I-C of Ecology’s Stormwater Management Manual for Western Washington (Ecology 2019) for additional guidance.</i></p> <p>d. <i>Wetland Protection Standard—Method 2: Site Discharge Modeling. The total volume of stormwater discharging from the site into a wetland shall not be more than:</i></p> <ol style="list-style-type: none"> 1) <i>On a daily basis, 20 percent higher or lower than the pre-project volume, and</i> 2) <i>On a monthly basis, 15 percent higher or lower than the pre-project volume.</i> <p><i>Projects triggering Method 2 shall refer to I-C-5, Wetland Hydroperiod Data Collection and Evaluation Procedures, presented in Appendix I-C of Ecology’s Stormwater Management Manual for Western Washington (Ecology 2019) for additional guidance.</i></p>	

5.3.2. Pre-Developed Forested Standard

Stormwater Code Language	References
<p>SMC 22.805.080.B.2 – <i>The post-development discharge durations shall match the discharge durations of a pre-developed forested condition for the range of pre-developed discharge rates from 50 percent of the 2-year peak flow to the 50-year peak flow.</i></p>	<ul style="list-style-type: none"> ● <i>Volume 3, Section 3.4 – BMP Selection for Flow Control</i> ● <i>Volume 3, Section 4.1 – Sizing Approach</i> ● <i>Appendix F – Hydrologic Analysis and Design</i>

5.3.3. *Pre-Developed Pasture Standard*

Stormwater Code Language	References
<p>SMC 22.805.080.B.3 – <i>The post-development discharge durations shall match the discharge durations of a pre-developed pasture condition for the range of pre-developed discharge rates from 50 percent of the 2-year peak flow to the 2-year peak flow.</i></p>	<ul style="list-style-type: none"> • <i>Volume 3, Section 3.4 – BMP Selection for Flow Control</i> • <i>Volume 3, Section 4.1 – Sizing Approach</i> • <i>Appendix F – Hydrologic Analysis and Design</i>

5.3.4. *Existing Condition Standard*

Stormwater Code Language	References
<p><u>SMC 22.805.080.B.4</u></p> <p>a. <u>The post-development discharge durations shall be limited as follows:</u></p> <ol style="list-style-type: none"> 1) <u>Match the discharge durations of the existing land cover condition for the range of discharge rates from 50 percent of the 2-year peak flow to the 25-year peak flow, and</u> 2) <u>For discharges to a creek or a creek drainage basin or to a small lake or a small lake basin, also match the discharge durations of the existing land cover condition for the range of discharge rates from 50 percent of the 2-year peak flow to the 50-year peak flow.</u> 	<ul style="list-style-type: none"> • <u>Volume 3, Section 3.4 – BMP Selection for Flow Control</u> • <u>Volume 3, Section 4.1 – Sizing Approach</u> • <u>Appendix F – Hydrologic Analysis and Design</u>

Existing conditions means the conditions of drainage, vegetation, and impervious cover at the time of analysis.

5.3.5. *Peak Control Standard*

Stormwater Code Language	References
<p>SMC 22.805.080.B.5</p> <p>a. <u>The post-development release rates shall be limited as follows:</u></p> <ol style="list-style-type: none"> 1) <u>The peak flow with a 50 percent annual probability (2-year recurrence flow) shall not exceed 0.07 cubic feet per second per acre;</u> 2) <u>The peak flow with a 20 percent annual probability (5-year recurrence flow) shall not exceed 0.10 cubic feet per second per acre; and</u> 3) <u>The peak flow with a 4 percent annual probability (25-year recurrence flow) shall not exceed 0.40 cubic feet per second per acre.</u> 	<ul style="list-style-type: none"> • <i>Volume 3, Section 3.4 – BMP Selection for Flow Control</i> • <i>Volume 3, Section 4.1 – Sizing Approach</i> • <i>Appendix F – Hydrologic Analysis and Design</i>

5.4. Water Quality Treatment

Projects triggering this minimum requirement based on the amount of pollution generating surface shall install water quality treatment BMPs, which typically remove pollutants through a combination of gravity settling, filtration, biological uptake, and soil adsorption. General

water quality treatment requirements included in SMC, Section 22.805.090 are summarized below.

Note:

- Projects with 35 percent or greater existing hard surface may manage a smaller portion of the project’s new and replaced hard surface area to meet water quality treatment requirements if only On-site BMPs are employed. Specifically, if water quality treatment is required and only On-site BMPs are used, the hard surface area requiring management may be reduced by up to 2,000 square feet if On-site BMPs are utilized to the maximum extent feasible.
- [An approved landscape management plan \(LMP\) can be used as an alternative to the requirement to formally treat \(with a water quality treatment BMP\) the runoff from pollution generating pervious surfaces subject to water quality treatment. A LMP is a City approved plan for defining the layout and long-term maintenance of landscaping features to minimize the use of pesticides and fertilizers, and reduce the discharge of suspended solids and other pollutants. Runoff from an impervious area that is routed to a pervious area is not included in a LMP and must be addressed separately through applying Minimum Requirements #5, #6, and/or #7. LMPs do not apply to artificial turf fields. LMPs are required to be updated if the layout of landscaping features will be substantially modified or if specific maintenance approaches will be altered from the approved LMP. Refer to Appendix I for LMP submittal requirements.](#)
- Refer to *Volume 3, Section 4.4* for applicable presettling and pretreatment requirements.

Stormwater Code Language	References
<p><i>SMC, Section 22.805.090 –</i></p> <p><i>A. Applicability. The requirements of this subsection apply to the extent required in Section 22.805.050 to Section 22.805.060.</i></p> <p><i>B. Requirements. Water quality treatment facilities shall be installed to the extent allowed by law and maintained pursuant to rules promulgated by the Director to treat flows from the pollution-generating pervious and hard surfaces on the site being developed. When stormwater flows from other areas, including non-pollution generating surfaces (e.g., roofs), dewatering activities, and off-site areas, cannot be separated or bypassed, treatment BMPs shall be designed for the entire area draining to the treatment facility. All projects shall use on-site BMPs identified in Section 22.805.070.D to the maximum extent feasible to meet the minimum requirements. For pollution-generating pervious surfaces other than artificial turf, a landscape management plan developed according to rules promulgated by the Director may be utilized in lieu of installing water quality treatment facilities.</i></p>	<ul style="list-style-type: none"> ● <i>Volume 1, Section 4.3.4 – Treatment Requirements for Roadway Projects</i> ● <i>Volume 1, Section 4.4.4 – Treatment Requirements for Parcel-Based Projects</i> ● <i>Volume 1, Section 5.4.1.1 – Runoff Treatment Volume</i> ● <i>Volume 1, Section 5.4.1.2 – Runoff Treatment Rates</i> ● <i>Volume 1, Section 5.4.1.3 – Infiltration Treatment Requirements</i> ● <i>Volume 3, Section 4.4 – Presettling and Pretreatment Requirements</i>

Water quality treatment BMPs shall be designed based on the stormwater runoff volume from the contributing area or a peak flow rate as outlined in the following subsections.

5.4.1. General Water Quality Treatment Requirements

5.4.1.1. Runoff Treatment Volume

The water quality design treatment volume is determined as follows:

Stormwater Code Language	References
<p>SMC, Section 22.805.090.B.1.a – <i>The daily runoff volume at or below which 91 percent of the total runoff volume for the simulation period occurs, as determined using an approved continuous model. It is calculated as follows:</i></p> <ol style="list-style-type: none"> 1) <i>Rank the daily runoff volumes from highest to lowest.</i> 2) <i>Sum all the daily volumes and multiply by 0.09.</i> 3) <i>Sequentially sum daily runoff volumes, starting with the highest value, until the total equals 9 percent of the total runoff volume. The last daily value added to the sum is defined as the water quality design volume.</i> 	<ul style="list-style-type: none"> ● <i>Volume 1, Section 5.4.1.3 – Infiltration Treatment Requirements</i> ● <i>Volume 3, Section 4.1 – Sizing Approach</i> ● <i>Appendix F – Hydrologic Analysis and Design</i>

5.4.1.2. Runoff Treatment Rates

Stormwater Code Language	References
<p>SMC, Section 22.805.090.B.1.b – <i>Different design flow rates are required depending on whether a treatment facility will be located upstream or downstream of a detention facility:</i></p> <ol style="list-style-type: none"> 1) <i>For facilities located upstream of detention or when detention is not required, the design flow rate is the flow rate at or below which 91 percent of the total runoff volume for the simulation period is treated, as determined using an approved continuous runoff model.</i> 2) <i>For facilities located downstream of detention, the design flow rate shall be the full 2-year release rate, as determined using an approved continuous runoff model.</i> 	<ul style="list-style-type: none"> ● <i>Volume 3, Section 4.1 – Sizing Approach</i> ● <i>Appendix F – Hydrologic Analysis and Design</i>

5.4.1.3. Infiltration Treatment Requirements

Stormwater Code Language	References
<p>SMC, Section 22.805.090.B.1.c – <i>Infiltration facilities designed for water quality treatment must infiltrate 91 percent of the total runoff volume as determined using an approved continuous runoff model. To prevent the onset of anaerobic conditions, an infiltration facility designed for water quality treatment purposes must be designed to drain the water quality design treatment volume (the 91st percentile, 24-hour volume) within 48 hours.</i></p>	<ul style="list-style-type: none"> ● <i>Volume 1, Section 5.4.1.1 – Runoff Treatment Volume</i> ● <i>Volume 3, Section 4.1 – Sizing Approach</i> ● <i>Volume 3, Section 4.4 – Presettling and Pretreatment Requirements</i> ● <i>Appendix F – Hydrologic Analysis and Design</i>

Note that the “91st percentile, 24-hour volume” referenced above represents the upper limit of the range of daily volumes that accounts for 91 percent of the entire runoff volume over a multi-decade period of record.

5.4.2. Water Quality Treatment Standards

Projects triggering this minimum requirement shall install water quality treatment BMPs for the given project type, size, and discharge location as summarized in *Chapter 2*. Refer to *Section 5.4.2.1* through *5.4.2.4* for oil, phosphorus, enhanced, and basic water quality treatment standards.

When triggered, water quality treatment BMPs shall be installed to treat flows from the pollution-generating hard surface (PGHS) and pollution-generating pervious surface (PGPS) on the site being developed. When stormwater flows from other areas, including non-PGHS (e.g., roofs), dewatering activities, and flows that cannot be separated or bypassed, water quality treatment BMPs shall be sized for the combined total flow. ~~*Direct discharge of untreated drainage water to groundwater is prohibited (SMC, Section 22.805.090.B.6).*~~

Stormwater Code Language	References
<i>SMC, Section 22.805.090.B.6 – Discharges to Groundwater. Direct discharge of untreated drainage water from pollution-generating hard surfaces to groundwater is prohibited.</i>	<ul style="list-style-type: none"> SMC, Section 22.805.090.B.6 – Minimum Requirements for Treatment

~~Excerpts from the Stormwater Code (in italics) are presented below in the first column in each section. The second column in each section provides applicable references.~~

5.4.2.1. Oil Control Treatment

Oil control treatment applies to projects that include “high-use sites” or have NPDES permits that require application of oil control. Oil control treatment is in addition to other water quality treatment requirements (i.e., phosphorus, enhanced, or basic). The petroleum storage and transfer criterion is intended to address regular transfer operations such as gasoline service stations.

The project proponent shall develop an Average Daily Traffic (ADT) estimate for approval by the City (<http://data-seattlecitygis.opendata.arcgis.com/search?tags=transportation> www.seattle.gov/transportation/tfdmaps.htm). In addition to the typical sites outlined in the definition for high-use site, the City may also require oil control treatment to be used on other sites that have the potential to generate high concentrations of oil or with oil handling activity.

Stormwater Code Language	References
<p><i>SMC, Section 22.805.090.B.3 – An oil control treatment facility shall be required for high-use sites, as defined in this subtitle.</i></p> <p><i>SMC, Section 22.801.090 – “High-use sites” means sites that typically generate high concentrations of oil due to high traffic turnover or the frequent transfer of oil. High-use sites include:</i></p> <ol style="list-style-type: none"> <i>An area of a commercial or industrial site subject to an expected average daily traffic (ADT) count equal to or greater than 100 vehicles per 1,000 square feet of gross building area;</i> 	<ul style="list-style-type: none"> Volume 3, Section 3.5 – BMP Selection for Water Quality Treatment

<ol style="list-style-type: none"> 2. An area of a commercial or industrial site subject to petroleum storage and transfer in excess of 1,500 gallons per year, not including routinely delivered heating oil; 3. An area of a commercial or industrial site subject to parking, storage or maintenance of 25 or more vehicles that are over 10 tons gross weight (trucks, buses, trains, heavy equipment, etc.); 4. A road intersection with a measured ADT count of 25,000 vehicles or more on the main roadway and 15,000 vehicles or more on any intersecting roadway, excluding projects proposing primarily pedestrian or bicycle use improvements. 	
--	--

5.4.2.2. Phosphorus Treatment

The requirement to provide phosphorus treatment is determined by the discharge location of the project. Phosphorus treatment is required for projects discharging stormwater to or infiltrating within 1/4 mile of a nutrient-critical receiving water or a tributary to that water. [If the soil suitability criteria for infiltrating BMPs are met \(refer to Volume 3, Section 4.5.2\) and pre-settling is provided \(refer to Volume 3, Section 4.4\), then it is assumed that the phosphorus treatment performance goal is met.](#)

At the time this Manual was developed, there were no nutrient-critical receiving water segments determined to be impaired due to phosphorus contributed by stormwater. In the future, the City may designate a waterbody as a nutrient-critical receiving water as defined by the SMC, Section 22.801.150. Refer to the SDCI website to determine if any nutrient-critical receiving waters have been designated ([www.seattle.gov/sdci/codes/codes-we-enforce-\(a-z\)/stormwater-codewww.seattle.gov/dpd/codesrules/codes/stormwater](http://www.seattle.gov/sdci/codes/codes-we-enforce-(a-z)/stormwater-codewww.seattle.gov/dpd/codesrules/codes/stormwater)).

Stormwater Code Language	References
SMC, Section 22.805.090.B.4 – A phosphorus treatment facility shall be required for projects discharging into nutrient-critical receiving waters.	<ul style="list-style-type: none"> • Volume 3, Section 3.5 – BMP Selection for Water Quality Treatment • Volume 3, Section 4.4.3.2 – Pretreatment

Project sites subject to the phosphorus treatment requirement could also be subject to the oil treatment and enhanced treatment requirements (Section 5.4.2.1 and Section 5.4.2.3).

5.4.2.3. Enhanced Treatment

The requirement to provide enhanced treatment is determined by the discharge location of the project and activities occurring on the project site. [If the soil suitability criteria for infiltrating BMPs are met \(refer to Volume 3, Section 4.5.2\) and pre-settling is provided \(refer to Volume 3, Section 4.4\), then it is assumed that the enhanced treatment performance goal is met.](#)

Stormwater Code Language	References
<p>SMC, Section 22.805.090.B.5 – <i>Enhanced Treatment. Unless a project discharges to a basic treatment receiving water (subsection 22.801.030 “B”), an enhanced treatment facility for reducing concentrations of dissolved metals shall be required for projects that discharge, directly or through conveyance systems, to fresh waters designated for aquatic life use or having an existing aquatic life use, or that use infiltration strictly for flow control (not treatment) and discharge within one-quarter mile of fresh waters designated for aquatic life use or having an existing aquatic life use, if the project meets one of the following criteria:</i></p> <ol style="list-style-type: none"> a. <i>For a parcel-based project, the project is industrial, is commercial, or proposes four or more dwelling units.</i> b. <i>For a roadway project, the site is either:</i> <ol style="list-style-type: none"> 1. <i>A fully controlled or a partially controlled limited access highway with Annual Average Daily Traffic counts of 15,000 or more; or</i> 2. <i>Any other road with an Annual Average Daily Traffic count of 7,500 or greater.</i> 	<ul style="list-style-type: none"> • <i>Volume 3, Section 3.5 – BMP Selection for Water Quality Treatment</i> • <i>Volume 3, Section 4.4.3.2 – Pretreatment</i>

Note: Sites not considered residential, industrial, or road-related are considered commercial for the purposes of applying enhanced treatment requirements. Examples include transit facilities, parks, and schools.

~~Sites that discharge directly (or, indirectly through a drainage system) to a Basic Treatment Receiving Water (Section 5.4.2.4) are not subject to enhanced treatment requirements. Likewise, a~~ Any portion of a project site that is identified as subject to basic treatment requirements only (Section 5.4.2.4) are not subject to enhanced treatment requirements.

Project sites subject to the enhanced treatment requirement could also be subject to the oil control treatment requirement (Section 5.4.2.1) and phosphorus treatment requirement ~~if discharging to a nutrient-critical receiving water~~ (Section 5.4.2.2).

5.4.2.4. *Basic Treatment*

Projects triggering water quality treatment shall install, at a minimum, a BMP facility that meets the basic treatment requirements. The requirements for oil control treatment (which may also be required if the project includes “high-use sites,” refer to Section 5.4.2.1), phosphorus treatment, and enhanced treatment are in addition to the basic treatment requirement. If the soil suitability criteria for infiltrating BMPs are met (refer to Volume 3, Section 4.5.2) and pre-settling is provided (refer to Volume 3, Section 4.4), then it is assumed that the basic treatment performance goal is met. Areas that must provide phosphorus treatment or enhanced treatment do NOT have to provide additional basic treatment BMPs to meet the basic treatment performance goal.

Basic treatment is required in the following circumstances:

- Project sites that discharge stormwater to the ground (i.e., via infiltration) UNLESS:
 - The soil suitability criteria for infiltration treatment are met (refer to *Volume 3, Section 4.5.2*) and pre-settling is provided (refer to *Volume 3, Section 4.4*), or

- The project site uses infiltration strictly for flow control – not treatment—~~and the discharge is within 1/4 mile of a nutrient critical receiving water (refer to Section 5.4.2.2),~~ or
- The project site is required to provide enhanced treatment (refer to Section 5.4.2.3).
- Single-family residential projects not otherwise required to provide phosphorus control (Section 5.4.2.2) as designated by EPA, Ecology, or the City.
- Project sites discharging directly (or indirectly through a drainage system) to the following Basic Treatment Receiving Waters:
 - All marine waters, including Puget Sound
 - Lake Union
 - Lake Washington
 - Ship Canal and bays between Lake Washington and Puget Sound
 - Duwamish River
- Project sites that drain to fresh waters, or to waters tributary to fresh waters, that are not designated for aquatic life use and that do not have an existing aquatic life use. As provided in Chapter 173-201A WAC, all surface waters of the state, including but not limited to wetlands, in or near the City are to be protected for designated aquatic life use. For the purposes of the Stormwater Code and this Manual, the City of Seattle interprets “fresh waters designated for aquatic life use” to include at minimum fresh water wetlands as well as small lakes, creeks, and freshwater designated receiving waters.
- Landscaped areas of industrial, commercial, and ~~multi-family-multifamily~~ project sites.
- ~~Parking lots of industrial and commercial project sites, dedicated solely to parking of employees’ private vehicles that do not involve any other pollution-generating activities (e.g., industrial activities; customer parking; storage of erodible or leachable material, wastes, or chemicals; vehicle maintenance).~~

Stormwater Code Language	References
<p><i>SMC, Section 22.805.090.B.2 – A basic treatment facility shall be required for all projects. The requirements of subsection 22.805.090.B.3 (Oil Control Treatment), subsection 22.805.090.B.4 (Phosphorus Treatment), subsection 22.805.090.B.5 (Enhanced Treatment) are in addition to this basic treatment requirement.</i></p>	<ul style="list-style-type: none"> ● <i>Section 5.4.1 (SMC, Section 22.805.090.B.3) – Oil Control Treatment</i> ● <i>Section 5.4.2 (SMC, Section 22.805.090.B.4) – Phosphorus Treatment</i> ● <i>Section 5.4.3 (SMC, Section 22.805.090.B.5) – Enhanced Treatment</i> ● <i>Volume 3, Section 3.5 – BMP Selection for Water Quality Treatment</i> ● <i>Volume 3, Section 4.1 – Sizing Approach</i> ● <i>Appendix F – Hydrologic Analysis and Design</i>

~~Note that in addition to basic treatment, oil control treatment may also be required if the project includes “high use sites.” Refer Section 5.4.2.1.~~

CHAPTER 6 – ALTERNATIVE COMPLIANCE

[Alternative compliance in creek basins applies only within the city of Seattle. An excerpt from the Stormwater Code \(in *italics*\) is presented below.](#)

Stormwater Code Language	References
<p><i>SMC 22.800.080 – Authority</i></p> <p><i>E. The Director of SPU is authorized, to the extent allowed by law, to develop, review, or approve an Integrated Drainage Plan as an equivalent means of complying with the requirements of this subtitle, in which the developer of a project voluntarily enters into an agreement with the Director of SPU to implement an Integrated Drainage Plan that is specific to one or more sites where best management practices are employed such that the cumulative effect on the discharge from the site(s) to the same receiving water is the same or better than that which would be achieved by a less integrated, site-by-site implementation of best management practices. (SMC 22.800.080.E)</i></p> <p><i>F. For projects that do not discharge to the combined sewer system, the Director of SPU is authorized, to the extent allowed by law, to enter into an agreement with the developer to allow a project’s flow control, water quality treatment, on-site stormwater management, or wetland protection requirements to be met at an alternative location if the following conditions are met, or if another scenario is approved by Ecology:</i></p> <ol style="list-style-type: none"> <i>1. The developer enters the agreement voluntarily to contribute funds toward the construction of, or to construct, one or more drainage control facilities at an alternative location to mitigate the impacts to the same receiving water that have been identified as a consequence of the project; and</i> <i>2. The alternative location is for an equivalent area in terms of flow and pollution characteristics when compared with the project, as determined by the Director; and</i> <ol style="list-style-type: none"> <i>a. The site of the project has greater than or equal to 35 percent existing hard surface coverage and the project discharges to:</i> <ol style="list-style-type: none"> <i>1) A Listed Creek and the equivalent area is in-basin, which means that the equivalent area is on the same site as the project, the project is located within contributing area to the equivalent area, or the equivalent area discharges from the public drainage system to the receiving water at the same point as (or upstream of) the point where the project area discharges from the public drainage system to the same receiving water; or</i> <i>2) A receiving water other than a Listed Creek and the equivalent area discharges to the same receiving water as the project. (SMC 22.800.080.F)</i> <p><i>G. For projects that discharge to the combined sewer system, the Director of SPU is authorized, to the extent allowed by law, to enter into an agreement with the developer to allow a project’s flow control or on-site stormwater management requirements to be met at an alternative location if the developer enters the agreement voluntarily to contribute funds towards the construction of, or to construct, one or more drainage control facilities at an alternative location, determined by the Director, to mitigate the impacts that have been identified as a consequence of the project. (SMC 22.800.080.G)</i></p>	<ul style="list-style-type: none"> ● Not applicable

When the consequences of the proposed development are from new [impervious-hard](#) surfaces, the mitigation should be provided at the same time as completion of the new surfaces. When the consequences of the proposed development are from replaced [impervious-hard](#) surfaces, there should be a construction plan and schedule that ensure the stormwater control BMP(s) mitigating the impacts are constructed within 5 years of the original development, which may be required by state law.

CHAPTER 7 – SITE ASSESSMENT AND PLANNING

To help evaluate minimum requirements and start the process for selecting on-site stormwater management, flow control, and water quality treatment [best management practices](#) (BMPs), each project shall assess and evaluate existing and post-development site conditions. This chapter describes typical site information and design considerations to be identified early in the project development process. The goal of site assessment and planning is to identify any additional stormwater management issues that shall be addressed before selecting on-site stormwater management, flow control, and/or water quality treatment BMPs. Additional information on drainage control reviews and required plan submittals is included in *Chapter 8*.

7.1. Identifying Key Project Components

Chapter 3 presents steps for determining the applicable on-site stormwater management, flow control, and water quality treatment requirements. The following sections provide additional guidance on key project components that can significantly influence the project design and approach, and should be considered as part of the site assessment and planning step.

7.2. Project Boundaries and Structures

Project boundaries, nearby structures, and other related issues can directly affect [designs for stormwater management designs](#). The following shall be addressed before selecting a stormwater BMP:

- Project Boundaries: The project boundaries typically define the limits of disturbance and can affect the thresholds and applicable minimum requirements. Project boundaries generally coincide with the right-of-way and/or property line, [but may include multiple properties. Refer to Section 2.1.](#)
- Setbacks: Property lines, existing and proposed structures, and adjacent right-of-way boundaries shall be identified and considered to evaluate project impacts on adjacent properties.
- Location of Buildings: All existing and proposed buildings shall be identified, including all existing and proposed temporary and permanent structures ([e.g., such as](#) retaining walls) and [hard impervious](#) surfaces ([e.g.,](#) driveways [and,](#) patios, [etc.](#)). Structures on neighboring properties can also affect stormwater BMP selection.
- Foundations and Footing Drains: The type of proposed foundations and footing drains, including location and extent, shall be determined, to include the following:
 - Conventional spread footings
 - Pile shaft
 - Basement

- Footing drains and their associated point of discharge, where applicable ([refer to Section 3.2.1](#))
- Water-tight foundation without footing drains
- Elevation of groundwater table in relation to the footings and basement

7.3. Soil Condition Assessment

The soil type and land cover types on the project [site](#) shall be evaluated to assess the infiltration capacity of the site and the applicability of various stormwater BMPs. General requirements for [determining](#) infiltration feasibility, site characterization, and infiltration rate ~~determination~~ are presented in *Volume 3, Sections [3.2 and 4.5.2](#) and Appendix D*.

7.4. Environmentally Critical Areas (ECAs)

Additional regulatory requirements are placed upon projects that are within or near ECAs, pursuant to SMC, Chapter 25.09. Depending upon the type of ECA, additional requirements or limitations regarding stormwater management may apply.

[The following information is needed to assess the impacts on and risks posed to wetlands and to determine the necessary protection level:](#)

- [Size, boundary, and characteristics of the proposed project site, wetland contributing drainage area, and the wetland and its buffer](#)
- [Wetland type, category, and habitat score \(based on the Wetland Protection Guidelines in the Stormwater Management Manual for Western Washington \(SWMMWW\) Volume I, Appendix I-C \[Ecology 2019\]\)](#)
- [Presence of rare, endangered, threatened, or sensitive species](#)
- [Presence of breeding populations of native amphibian species](#)
- [Legal access to the wetland](#)

7.5. Dewatering

It is important to have early estimations of the groundwater discharge from the project site. The site's proximity to receiving waters, or its location in areas where there may be perched, static, tidally influenced, or hydraulically connected groundwater can have significant impacts on how the project is designed and which other minimum requirements apply. Refer to the Minimum Requirements for Flow Control (*Section 5.3*) and the Minimum Requirements [to Ensure Sufficient Capacity \(Section 3.8\)](#).

If temporary dewatering ~~will~~[shall](#) occur, a Side Sewer Permit for Temporary Dewatering (SSPTD) and a Discharge Authorization Letter from King County Industrial Waste may be required prior to commencing dewatering at the site. The SSPTD ~~permit~~ may require compliance with a separate Temporary Dewatering Plan, water quality treatment, flow control requirements, and ~~also require~~ compliance monitoring.

7.6. Topography

Because topography will influence how and where stormwater BMPs are incorporated onto the site, the existing and proposed topography shall be considered. Important features to assess include the following:

- Key terrain features, such as closed depressions and grade breaks
- Natural drainage courses, such as swales, ditches, rills, and gullies
- Flow entering and exiting the property
- Roadway grades and elevations

7.7. Site Assessment

The following information shall be evaluated as part of the site assessment:

- **Topography:** Topography within 500 feet of the site ([geographic information system \[GIS\]](#)) topographic data may be used
- **Steep Slope or Landslide-Prone Areas:** Location of steep slope areas or landslide-prone areas within 500 feet of the site
- **Septic Systems and Drain Fields:** Location of septic systems and drain fields in the vicinity of the site
- **Underground Storage Tanks, Aboveground Storage Tanks, Residential Heating Oil Tanks:** Location of underground storage tanks, above ground storage tanks, or residential heating oil tanks in the vicinity of the site
- **Contaminated Sites and Landfills:** Location of contaminated sites and abandoned landfills within 100 feet of the site

For roadway projects or parcel-based projects with runoff from 5,000 square feet or more of impervious area ~~to infiltrated on the site~~, the following information shall also be evaluated:

- **Site Geology:** Local site geology, including soil or rock units likely to be encountered, the groundwater regime, and geologic history of the site
- **Water Supply Wells:** Location of water supply wells within 500 feet of the site
- **Contaminated Sites and Landfills:** Location of contaminated sites and abandoned landfills within 500 feet of the site
- **Groundwater Protection Areas:** Location of groundwater protection areas and/or 1-, 5-, and 10-year time of travel zones for municipal well protection areas
- **Anticipated Site Use:** ~~Anticipated site use (Street/highway, residential, commercial, high-use site that may affect the water quality of stormwater runoff)~~

For projects proposing to use deep infiltration BMPs, the following information shall also be reviewed and mapped:

- Regional geologic mapping
- Publicly available geotechnical exploration data

- Steep slope and landslide-prone areas within a quarter mile ~~(1,320 feet)~~ of proposed ~~location of the~~ deep infiltration BMP ~~location~~

Sources of data to evaluate site suitability include, but are not limited to, City of Seattle Department of Construction and Inspection [\(SDCI\)](#) Critical Area maps, Washington Department of Natural Resources [\(DNR\)](#) Subsurface GIS, Flood Hazard maps, and other mapping information available from the City of Seattle (including Seattle Public Utilities [\[SPU\]](#) and the Seattle Department of Transportation [\[SDOT\]](#)), King County, and consultant reports for other public agencies. Any of the above information identified as part of the review shall be shown on a map relative to the proposed infiltration location(s).

Using the site assessment information, evaluate the site for infiltration suitability based on the limitations and setbacks provided in *Volume 3, Section 3.2* and *Appendix D, Section D-2.2.4*. Based on this evaluation, identify all portions of the site where infiltration may be feasible. Additionally, for [underground injection control \(UIC\)](#) wells, setback and site restrictions shall be in accordance with the UIC [requirements in Volume I of the SWMMWW Guidance Manual](#) (Ecology [20192006](#)). [UIC wells are regulated by the Washington State Department of Ecology \(Ecology\) under federal and state laws and must comply with all federal and state requirements.](#)

7.8. [Landscaping Principles](#)

Before designing the site and stormwater infrastructure, consider the following:

- Maintain and use natural drainage patterns
- Preserve and use natural features and resources, including trees
- [Preserve native vegetation \(refer to BMP T5.40, Preserving Native Vegetation, in Volume V of the SWMMWW \[Ecology 2019\]\)](#)
- Create a multifunctional landscape using the natural site hydrology as a framework for site design
- Confine and phase construction activities to minimize disturbed areas, and ~~minimize~~ [impacts onto ECAs environmentally critical areas](#) and their associated buffers
- Plant new trees in proximity to ground-level impervious surfaces for on-site stormwater management and/or flow control credit
- Minimize or prevent compaction and protect soils

[Soil type, slope, exposure, depth to groundwater, and the suite of plants chosen for the site will all influence the proposed landscape management approach. However, there are five basic principles that must be considered for all sites to be successful in controlling the export of soil or organic matter, fertilizers, and pesticides in stormwater runoff:](#)

- [Minimize bare soil areas](#)
- [Reduce water demand](#)
- [Reduce extent of turf area and manage remaining turf to reduce pollutant impact](#)
- [Select plants with sustainability in mind](#)

- Reduce or eliminate fertilizers, pesticides, herbicides, and fungicides and, where required, manage application wisely

Each of the five basic principles is expanded upon in the following subsections. The recommendations discussed for each principle are intended as a framework for a variety of site situations, from individual homes to large parks and golf courses. The specific application of each of these principles will vary from site to site depending on the type of landscaping (e.g., grass lawn, planter bed) that is being managed.

7.8.1. Principle 1: Minimize Bare Soil Areas

Bare soil areas are one source of solids that can be mobilized and carried downstream by rainfall. Minimizing bare soil areas makes it less likely that solid particles will be dislodged by rainfall. Landscapes can be managed to minimize bare soil using one or more of the following:

- Establish dense plantings of pest-resistant groundcover to shade out weeds. Some easy-care recommendations are rock rose (*Cistus sp.*), snowberry (*Symphoricarpus alba*), salal (*Gaultheria shallon*) and kinnickinick (*Arctostaphylos uva-ursi*).
- If bare soil areas are required, as in planting beds or ball diamonds, surround the bare area with an area of grass or groundcover to filter out solids that may be picked up by stormwater runoff.
 - The denser the grass or groundcover, the more effective it will be in capturing solids in runoff.
 - The filtering area should be as level as possible, minimizing low spots, where runoff can concentrate and create channels.
 - In general, filtering areas should be about one-fourth as long (along the flowpath) as the area contributing flow, assuming that the slopes are gentle (less than 10 percent). For flat, level areas without dips, this length can be reduced.
- Promptly repair bare patches in lawns or groundcovers that could contribute solids to stormwater runoff.
- Do not place bark or loose mulch on slopes where it can be carried to storm drains or receiving waters.

7.8.2. Principle 2: Reduce Water Demand

Reducing the need for irrigation reduces the potential movement of pollutants, conserves water, and saves money.

- Use drought-tolerant or native vegetation.
- Install underground irrigation systems timed to water at night or drip irrigation systems. Systems with automatic leak detection capability will reduce inadvertent runoff due to a break in the system.
- Increase the organic content of soils to improve its water-retention capability.
- Terrace sloped areas to improve water retention.

7.8.3. Principle 3: Reduce Turf Area and Manage Remaining Turf to Reduce Pollutant Impact

Turf requires care to look attractive. In addition to mowing, turf areas typically require water, fertilizer, and weed and disease control. However, some practices can reduce or minimize the amount of chemical controls needed.

- Amend soil with organic matter per *Volume 3, Section 5.1*.
- Decide whether all lawn area needs the same level of upkeep: let some areas have a less formal look, if possible, and reduce or eliminate fertilizer and pesticide use in those areas. Apply fertilizer only if the need is indicated by soil testing, and apply it at rates recommended by a soil testing laboratory for current conditions.
- Rely on irrigation and lawn aeration as the primary tools for maintaining healthy turf.
- Remove thatch each year to increase water penetration to grass roots and reduce runoff.
- In shady areas, plant groundcovers rather than grass. Turf grasses usually need at least partial sun to remain vigorous.

7.8.4. Principle 4: Select Plants with Sustainability in Mind

Plants differ in their ability to cope with different soils, rainfall conditions, pests, diseases, and microclimates. Techniques that can be used to create landscapes requiring less intervention include the use of resilient plant species, the selection of plants with adaptations for particular environments, and the creation of optimal microenvironments. Less watering and a reduced need for pesticide and fertilizer application means less potential for pollutants to leave the site.

- Select disease-resistant plants.
- Select drought-resistant groundcovers, shrubs, and trees in areas with poor soil or little shading.
- Group plants in clusters with tree, shrub, and groundcover layers to create a better micro-environment and to supply organic matter back to the soil.
- Include plants in the landscape that are important for beneficial insects such as parasitic wasps. If beneficial insects have nothing to sustain them, they will not stick around to control pests when you need them.
- Use dense plantings or close spacing to shade out weeds rather than herbicides.
- On steep slopes or erosion-prone areas, use plants with fibrous roots including, but not limited to, the following:
 - Ornamental grasses and lawn grasses
 - Dwarf rose (*Rosa gymnocarpa*) – native
 - Nootka rose (*Rosa nutkana*) – native
 - Rock rose (*Cistus* sp.)
 - Rugosa rose (*Rosa rugosa*)

- Evergreen huckleberry – native
- Salal (*Gaultheria shallon*) – native
- Salmonberry (*Rubus spectabilis*) – native
- Snowberry (*Symphoricarpos alba* or *Symphoricarpos mollis*) – native
- Sword fern (*Polystichum munitum*) – native
- Use wetland plants in areas with seeps or a high groundwater table.
- Attend to installation details. Write enforceable planting specifications that include details such as soil preparation, plant spacing, plant condition and size, planting depth, transplant handling and irrigation. During installation, inspect the planting to prevent the use of shortcuts such as blowing the soil mixture around root balls rather than digging the roots into amended native soils. Where possible, specify and install bare-root plants for improved adaptation to native soils.

7.8.5. Principle 5: Reduce or Eliminate Fertilizer, Pesticide, Herbicide, and Fungicide Use and Where, Required, Manage Application Wisely

Use of fertilizers, pesticides, and herbicides should be reduced or eliminated to the maximum extent feasible. However, if the landscape plants and turf simply will not survive without fertilization and some amount of pest management, an Integrated Pest Management plan or landscape management plan (refer to Appendix I) must address when and how these actions will be taken so that the impact on water quality will be reduced.

- Keep plants healthy by building healthy soil using composted organic material. Healthy plants can better resist diseases and insect pests.
- Tailor fertilizer formulation to lawn needs. Apply fertilizer only if the need is indicated by soil testing, and apply it at rates recommended by a soil testing laboratory for current conditions. Adjust the fertilizer application rate and timing of applications to avoid carry-off in stormwater runoff.
- Reduce the phosphorus (P) concentration in fertilizers when possible by using a low phosphorus formulation or formulations containing only nitrogen or potassium.
- Use an Integrated Pest Management approach to control pests (see Appendix I). Include non-chemical control options as a first-defense against pests.
- Encourage a diverse insect community in your landscape: Beneficial insects can help control pests, especially pests of trees and shrubs.
- Target pesticide application to the specific pest of concern. Avoid pesticide “mixes” targeting generic problems (such as weed and feed) unless you actually need each of the formulations for a current problem.
- Apply pesticides only during the life-stage when the pest is vulnerable.
- Use fungicides very sparingly; they disrupt the base of aquatic food webs. If you need to use fungicides, spray formulations with faster break-down times.
- Tolerate some weeds.

7.9. Site Design Considerations

To manage stormwater effectively and efficiently, site design for both the construction phase and ~~the~~ post-development condition should ~~coincide~~~~be done in unison~~ with the design and layout of the stormwater infrastructure. Efforts should be made, as required and encouraged by local development codes, to conserve natural areas, retain native vegetation, reduce impervious surfaces, and integrate stormwater controls into the existing site layout to the maximum extent feasible. With careful planning, these efforts will not only help achieve the minimum requirements contained in the Stormwater Code, but can also reduce impacts from development projects and ~~reduce~~ the costs of water quality treatment and flow control.

Before designing the site and stormwater infrastructure, consider the following:

- Stormwater:
 - Identify the approved point of discharge and conveyance system ~~flowpath~~~~flow path~~, both pipe and topographically
 - Manage stormwater runoff (quantity and quality) as close to the point of origin as possible
 - Minimize the ~~required~~ quantity of stormwater collection and conveyance systems ~~required~~
 - Use simple, nonstructural methods for stormwater management
 - Use dispersion, infiltration, rainwater harvesting, and alternative surface BMPs where feasible
- Impervious and Pervious Surfaces:
 - Fit development to the terrain to minimize land disturbance
 - For sites with varied soil types, locate impervious areas over less permeable soil (e.g., till). Minimize development over more porous soils. Use ~~areas of~~ porous soils ~~for~~~~by locating~~ bioretention and permeable pavement ~~over them~~.
 - Cluster buildings together
 - Minimize impervious surfaces (e.g., buildings ~~and~~ sidewalks)
 - Minimize pollution-generating hard surfaces (PGHS) (e.g., areas subject to vehicular use such as driveways and parking strips)
 - Minimize pollution-generating pervious surfaces (PGPS)

CHAPTER 8 – DRAINAGE CONTROL REVIEW AND APPLICATION REQUIREMENTS

Most construction and land use projects in Seattle require a permit from the Seattle Department of Construction and Inspection (SDCI) and/or the Seattle Department of Transportation (SDOT). There are two levels of Drainage Control Review types include required for construction permits: Preliminary Drainage Review, Standard Drainage Review, and Comprehensive Drainage Review. The type of Drainage Control Review required is based on the project type and the proposed total amount of new plus replaced hard surface and the total amount of land-disturbing activity.

Forms and submittal documents for projects not conducted in the right-of-way (typically on private property) can be found on the SDCI website ([www.seattle.gov/sdci/codes/codes-we-enforce-\(a-z\)/stormwater-code](http://www.seattle.gov/sdci/codes/codes-we-enforce-(a-z)/stormwater-code)www.seattle.gov/dpd/codesrules/codes/stormwater).

Forms and submittal documents for projects conducted in the right-of-way can be found on SDOT’s website (www.seattle.gov/transportation/permits-and-services/permits/street-improvement-permitswww.seattle.gov/transportation/stuse-sip.htm).

The City also has resources available at the SDCI Applicant Services Center, including SDCI staff available to answer questions, and relevant “Tips” with detailed information for construction projects. Visit the SDCI Applicant Services Center on the 20th floor of the Seattle Municipal Tower 700 Fifth Avenue, Seattle, Washington 98124, or the website (www.seattle.gov/sdciwww.seattle.gov/dpd).

Refer to Section 4.7 for additional information regarding complex projects.

Excerpts from the Stormwater Code (in italics) are presented below in the first column in the code reference box in most sections. The second column in the code reference box provides applicable references.

8.1. Preliminary Drainage Review

Preliminary Drainage Review is required for Master Use Permits (MUPs) summarized below.

Stormwater Code Language	References
<p><i>SMC 22.807.020.A – Thresholds for Drainage Control Review. Drainage control review and approval as described in subsection 22.807.020.B is required for any of the following:</i></p> <ol style="list-style-type: none"> <i>1. Preliminary drainage review and approval is required for applications for the following approvals:</i> <ol style="list-style-type: none"> <i>a. Subdivisions (Chapter 23.22);</i> <i>b. Short plats (Chapter 23.24);</i> <i>c. Unit lot subdivisions (Section 23.24.045)</i> 	<ul style="list-style-type: none"> • SMC, Section 22.807.020.B – Submittal Requirements for Drainage Control Review and Approval • SMC, Chapter 23.22 – Subdivisions • SMC, Chapter 23.24 – Short Plats

<p>d. Lot boundary adjustments (Chapter 23.28);</p> <p>e. Master use permits that would allow development that includes 750 square feet or more of new plus replaced hard surface or 5,000 square feet of land disturbing activity where the Director has determined that a preliminary drainage review is required considering, but not limited, to the following attributes of the site:</p> <ol style="list-style-type: none"> 1) Location within an environmentally critical area or buffer; 2) Proximity and tributary to an environmentally critical area or buffer; and 3) Proximity and tributary to an area with adequacy, erosion, water quality, or flooding problems. 	<ul style="list-style-type: none"> ● SMC, Section 23.24.045 – Unit lot subdivisions ● SMC, Chapter 23.28 – Lot boundary adjustments
--	---

The submittals required for Preliminary Drainage Review shall include the following, at a minimum. Refer to [Appendix B](#) for additional requirements for specific types of MUPs:

- [Preliminary Drainage Control Plan*](#). The required elements for a Preliminary Drainage Control Plan are the same as for a Drainage Control Plan for Standard or Comprehensive Review with the following differences:
 - [On-site Stormwater Management BMPs for proposed lots/parcels where the future development is unknown shall show conceptual BMPs.](#)
 - [Tables for estimated new and replaced hard surface area for each proposed lot, parcel, tract, etc.](#)
- [Preliminary Site Plan \(elements can be incorporated within Drainage Control Plan\)*](#). The required elements for a Preliminary Site Plan are the same as for a Site Plan for Standard or Comprehensive Review with the following differences:
 - [Details](#)
- [Preliminary On-site stormwater management documentation*](#)
- [Preliminary Drainage Report or Flow Control and Water Quality Documentation*](#)
 - [Tables for estimated hard surface coverage, etc.](#)
 - [*All submittals for Preliminary Drainage Review shall be identified as "Preliminary." Preliminary Drainage Review approval does not permit construction. Standard or Comprehensive Drainage Review approval will be required for all associated construction permits.](#)

[Note: Refer to Appendix B for instances when some of the listed items may be deferred to the construction permits rather than being submitted with the MUP application.](#)

8.2. Standard Drainage Review

Standard Drainage Review generally applies to projects that involve 750 square feet or more, but less than 1 acre, of land-disturbing activity, and less than 5,000 square feet of new plus replaced hard surface.

For a project with no offsite discharge point as determined by the Director ([refer to Volume 3, Section 4.3.2](#)) or includes development conducted in or near a receiving water

requiring a Hydraulic Project Approval (WAC 220-660), the drainage control plan shall be prepared by a licensed engineer (SMC 22.807.020.B.2.b) (refer to Volume 3, Section 4.3.2).

Stormwater Code Language	References
<p>SMC 22.807.020.A – <i>Thresholds for Drainage Control Review</i></p> <p>2. <i>Standard drainage review and approval is required for the following:</i></p> <ul style="list-style-type: none"> a. <i>Applications other than those listed in subsection 22.807.020.A.1 that include any land disturbing activity encompassing an area of 5,000 square feet or more, including demolition permits;</i> b. <i>Applications for a building permit or other construction permit that authorizes the construction or installation of 750 square feet or more of new plus replaced hard surface;</i> c. <i>Applications for which a grading permit or approval is required pursuant to Chapter 22.170;</i> d. <i>Applications for street use permits for the cumulative addition of 750 square feet or more of new plus replaced hard surface and land disturbing activity;</i> e. <i>City public works projects or construction contracts, including contracts for day labor and other public works purchasing agreements, for the cumulative addition of 750 square feet or more of new plus replaced hard surface and/or land disturbing activity to the site, except for projects in a City-owned right-of-way and except for work performed for the operation and maintenance of park lands under the control or jurisdiction of the Department of Parks and Recreation;</i> f. <i>Applications for approvals and contracts that include any new or replaced hard surface or any land disturbing activity on a site deemed a potentially hazardous location, as specified in Section 22.800.050 (Potentially Hazardous Locations);</i> g. <i>Applications for approvals that include any new hard surface in a Category I peat settlement-prone area delineated pursuant to Section 25.09.012;</i> h. <i>Whenever an exception to a requirement set forth in this Subtitle VIII or in a rule promulgated under this Subtitle VIII is desired, whether or not review and approval would otherwise be required, including, but not limited to, alteration of natural drainage patterns or the obstruction of watercourses;</i> i. <i>Whenever roadway project infeasibility pursuant to subsection 22.805.060.E is applied, whether or not review and approval would otherwise be required or</i> j. <i>Applications for approvals for activities or projects for:</i> <ul style="list-style-type: none"> 1. <i>Fueling at dedicated stations, for new or substantially altered fueling stations.</i> 2. <i>In-water and over-water fueling.</i> 3. <i>Maintenance and repair of vehicles and equipment.</i> 4. <i>Concrete and asphalt mixing and production.</i> 5. <i>Recycling, wrecking yard, and scrap yard operations.</i> 6. <i>Storage of liquids in aboveground tanks.</i> 7. <i>Other projects that the Director determines pose a hazard to public health, safety or welfare; endanger any property; adversely</i> 	<ul style="list-style-type: none"> ● SMC, Chapter 22.170 – Grading Code ● SMC, Section 22.800.050 – Potentially Hazardous Locations ● SMC, Section 22.805.060 – Minimum Requirements for Roadway Projects ● SMC, Section 25.09.012 – Designation and Definitions of Environmentally Critical Areas

<p><i>affect the safety and operation of City right-of-way, utilities, or other property owned or maintained by the City; or adversely affect the functions and values of an environmentally critical area or buffer.</i></p>	
---	--

The submittals required for Standard Drainage Review shall include the following, at a minimum:

- ~~Construction Stormwater Control~~ [and Soil Management](#) Plan (refer to *Volume 2—~~Construction Stormwater Control~~*) [including a dewatering plan if groundwater dewatering will occur.](#)
- ~~Post Construction Soil Management Plan~~ (refer to [and](#) *Volume 3, Section 5.1*)
- [Standard](#) Drainage Control Plan
 - Site and drainage control summary
 - Existing drainage infrastructure
 - Location of drainage discharge from the site
 - [Drainage collection and conveyance measures \(e.g., inlets, catch basins, maintenance holes, downspouts, drain lines, subgrade drainage, pumps, etc.\)](#)
 - [Identification of uphill run-on areas \(i.e., areas that may contribute stormwater runoff onto the project site\)](#)
 - On-site Stormwater Management BMPs and hard surface identification ([refer to see](#) On-site Stormwater Management documentation below)
 - Flow Control BMPs
 - [Water Quality Treatment BMPs](#)
 - [Source Control BMPs](#)
 - [Identification of the which of the following standards are met with each BMP using the following abbreviations:](#)
 - [On-site Stormwater Management \(OSM\)](#)
 - [Flow Control \(FC\)](#)
 - [Water Quality \(WQ\)](#)
 - [Source Control \(SC\)](#)
 - Maintenance instructions
- Site Plan (elements can be incorporated within Drainage Control Plan)
 - Address of project and permit number
 - Creeks, streams, shorelines and any other Environmentally Critical Areas (ECAs) [or their buffers](#)
 - Areas to be protected
 - Names, widths, and improvement types of adjacent streets and alleys
 - Type, location, and dimension of curbs, sidewalks, and street trees

- All other trees at least 6 inches in diameter or larger measured 4.5 feet above the ground
- Location of all existing and proposed driveways, parking areas, and other paved areas and hard surfaces
- Size and shape of current and proposed buildings (including overhangs) and all other structures (retaining walls, etc.)
- Entrances
- Building identifiers (for sites with more than one building)
- [Existing grades/ground elevations including contours, flow lines and/or slope arrows, and tops and bottoms of slopes, and retaining walls, etc.](#)
- [Proposed grades/ground elevations including contours, spot elevations, flow lines and/or slope arrows, tops and bottoms of slopes, and retaining walls, etc., with enough information to identify drainage patterns.](#)
- [Existing and proposed retaining walls](#)
- Existing and proposed below grade and above grade utilities and infrastructure
- Property line dimensions
- Existing and proposed easements
- Setbacks
- On-site stormwater management documentation:
 - Hard surface identification (e.g., roofs, driveways, sidewalks, patios)
 - On-site Stormwater Management BMP selection and sizing (refer to *Volume 3, Section 3.3*, and *Chapter 5*)
 - Documentation of On-site Stormwater Management BMPs determined to be infeasible (refer to *Appendix C*)
 - Where dispersion is not feasible, documentation demonstrating infeasibility (refer to *Volume 3, Section 3.1*)
 - Where infiltration is not feasible, documentation demonstrating infeasibility (refer to *Volume 3, Section 3.2*)
 - Subsurface investigation, infiltration test results, or groundwater analysis, as required per *Volume 3, Sections 3.2* and *5.4.1*, and *Appendix D*
- Flow control documentation, if triggered. Required documentation may include:
 - Flow control BMP selection and sizing (refer to *Volume 3, Section 3.4*, and *Chapter 5*)
 - Details of any flow control device assembly, including orifice and weir sizing and elevations, if used
 - Modeling documentation (refer to *Appendix F*)
 - [Subsurface investigation, infiltration test results, or groundwater analysis as required per *Volume 3, Sections 3.2* and *5.4.1*, and *Appendix D*](#)

- Memorandum of Drainage Control for projects not located in the right-of-way including, at a minimum (SMC, Section 22.807.020.B.1.d):
 - The legal description of the site
 - A summary of the terms and limitations of the drainage control plan
 - Identify all stormwater BMPs specific to the project (e.g., catch basins, permeable pavement surfaces, detention pipes, biofiltration swales, wash pads).
 - An agreement to inform future purchasers/successors/assignees of the existence, limitations, and inspection and maintenance requirements of the stormwater ~~control~~ BMPs
 - Landscape management plan (if applicable)
 - The side sewer permit number, date, and name
 - Permission for the City to enter the property for inspection, monitoring, correction, and abatement purposes
 - Acknowledgment by the owner(s) that the City is not responsible for the adequacy or performance of the drainage control plan, and a waiver of any and all claims against the City for any harm, loss, or damage related to the plan, or to drainage or erosion on the property, except for claims arising from the City's sole negligence
 - The owner(s)' signatures acknowledged by a notary public
- Operations and maintenance (O&M) plan for stormwater BMPs or include reference to the O&M requirements in *Appendix G* on the Drainage Control Plan

8.3. Comprehensive Drainage Review for Large Projects

<u>Stormwater Code Language</u>	<u>References</u>
<p><u>SMC 22.807.020.A – Thresholds for Drainage Control Review</u></p> <p><u>3. Comprehensive drainage review and approval is required for applications other than those listed in subsection 22.807.020.A.1 that include:</u></p> <p><u>a. Five thousand square feet or more of new plus replaced hard surface;</u></p> <p><u>b. One acre or more of land disturbing activity;</u></p> <p><u>c. Conversion of 3/4 acres or more of vegetation to lawn or landscaped area; or</u></p> <p><u>d. Conversion of 2.5 acres or more of native vegetation to pasture.</u></p>	<ul style="list-style-type: none"> ● <u>None provided</u>

~~Comprehensive Drainage Review Plan is required for projects involving 5,000 square feet or more of new plus replaced hard surface or 1 acre or more of land disturbing activity, shall be prepared by a licensed engineer.~~

In addition to the requirements of the Standard Drainage Review, the following information is required for the Comprehensive Drainage Review:

- ~~Comprehensive~~ A Drainage ~~Control Plan Report~~ including, ~~at a minimum~~ consisting of:
 - Comprehensive Drainage Control Construction Drawing including all elements of a Standard Drainage Control Plan.
 - A Comprehensive Construction Stormwater Control and Soil Management Plan narrative, supporting calculations, and supporting documents including the

[Checklist to Select Large Project Construction BMPs \(refer to Table 1b in Volume 2, Chapter 3\).](#)

- [A Comprehensive Drainage Control Report including, but not limited to \(see Appendix B for other required elements and recommended format\):](#)
 - A narrative detailing the proposed project, summary of minimum requirements, and proposed stormwater management
 - Narrative of existing conditions including drainage basins, existing surface types, soil conditions, groundwater conditions, Environmentally Critical Areas (ECAs), and known contamination
 - [Dispersion feasibility analysis and documentation \(refer to Volume 3, Section 3.1\)](#)
 - [Infiltration feasibility analysis and documentation \(refer to Volume 3, Section 3.2\)](#)
 - [On-site stormwater management documentation and supporting calculations \(if triggered\). Refer to Section 8.2.](#)
 - [Flow control documentation and supporting calculations \(if triggered\). Refer to Section 8.2.](#)
 - [Water quality documentation and supporting calculations \(if triggered\)](#)
 - [Landscape management plan \(if applicable\). Refer to Appendix I.](#)
 - [Source control documentation and calculations \(if required\)](#)
 - Drainage basin maps
 - Inspection and O&M requirements and schedule [for stormwater BMPs and for any applicable landscape management plans](#)

8.4. Additional Documentation

Additional information may be required by the Director based on project specifics (e.g., infeasibility evaluation, existing conditions) to allow adequate evaluation of a project for compliance with the requirements and purpose of the Stormwater Code and other laws and regulations.

Such information includes, but is not limited to:

- Soils analysis
- Geotechnical report
- Survey of existing native vegetation cover (SMC, Section 25.11.050)
- Topographic/boundary survey (SMC, Section 25.09.330)
- Environmental assessment for potentially contaminated sites
- [Downstream analysis](#)
- [Upstream analysis](#)
- [Basin analysis](#)

- [Landscape management plan \(See *Appendix I* for submittal requirements\)](#)
- [Closed contour analysis](#)

**THIS COVER TO BE REPLACED
WITH SPU-PROVIDED COVER**
VOLUME 2 —
CONSTRUCTION STORMWATER CONTROL

CITY OF SEATTLE
SEATTLE PUBLIC UTILITIES
DEPARTMENT OF CONSTRUCTION AND INSPECTIONS

July 2021

Note:

Some pages in this document have been purposely skipped or blank pages inserted so that this document will copy correctly when duplexed.

Table of Contents

CHAPTER 1 - Introduction.....	1-1
1.1. What is the Purpose of this Volume?	1-1
1.2. How Does this Volume Apply to Construction?	1-1
1.2.1. City of Seattle Requirements.....	1-1
1.2.2. How to Use This Volume	1-2
1.3. What is Considered “Compliance”?.....	1-2
1.3.1. Surface Water Quality	1-2
1.3.2. Groundwater Quality	1-3
1.3.3. Downstream Infrastructure and Resources.....	1-3
1.4. What is Considered “Out of Compliance”?	1-4
1.5. Purpose of Construction Stormwater Best Management Practices (BMPs)	1-5
CHAPTER 2 - Construction Stormwater Control and Soil Management Plan	2-1
2.1. Small Project Construction Stormwater Control and Soil Management Plan	2-1
2.2. Large Project Construction Stormwater Control and Soil Management Plan	2-3
2.3. Certified Erosion and Sediment Control Lead	2-3
2.3.1. Description	2-3
2.3.2. Purpose	2-3
2.3.3. Conditions Where Practice Applies.....	2-3
2.3.4. Certification Criteria	2-3
2.3.5. Duties and Responsibilities	2-4
CHAPTER 3 - Selecting Construction Stormwater Controls	3-1
CHAPTER 4 - Standards and Specifications for Construction Erosion and Sedimentation Control	4-1
4.1. Cover Practices	4-2
4.1.1. Temporary Cover Practices	4-2
4.1.1.1. BMP E1.10: Temporary Seeding	4-3
4.1.1.2. BMP E1.15: Mulching, Matting, and Compost Blankets	4-6
4.1.1.3. BMP E1.20: Clear Plastic Covering	4-11
4.1.2. Permanent Cover Practices	4-13
4.1.2.1. BMP E1.30: Preserving Natural Vegetation	4-14
4.1.2.2. BMP E1.35: Buffer Zones	4-17
4.1.2.3. BMP E1.40: Permanent Seeding and Planting	4-19
4.1.2.4. BMP E1.45: Sodding	4-22
4.1.2.5. BMP E1.50: High-Visibility Fence.....	4-24
4.2. Erosion Control Practices	4-25
4.2.1. Temporary Erosion Control BMPs	4-25
4.2.1.1. BMP E2.10: Stabilized Construction Access.....	4-27
4.2.1.2. BMP E2.15: Tire Wash.....	4-30
4.2.1.3. BMP E2.20: Construction Road Stabilization	4-32

4.2.1.4.	BMP E2.35: Check Dams	4-34
4.2.1.5.	BMP E2.40: Triangular Silt Dike (TSD)	4-37
4.2.1.6.	BMP E2.45: Dust Control	4-39
4.2.2.	Permanent Erosion Control BMPs	4-41
4.2.3.	Temporary or Permanent Erosion Control BMPs	4-42
4.2.3.1.	BMP E2.70: Subsurface Drains	4-43
4.2.3.2.	BMP E2.80: Earth Dike and Drainage Swale	4-45
4.3.	Sediment Control Practices	4-48
4.3.1.	BMP E3.10: Filter Fence	4-49
4.3.2.	BMP E3.20: Gravel Filter Berm	4-53
4.3.3.	BMP E3.25: Inlet Protection	4-54
4.3.4.	BMP E3.30: Vegetated Strip	4-59
4.3.5.	BMP E3.35: Straw Wattles, Compost Socks, and Compost Berms	4-60
4.3.6.	BMP E3.40: Sediment Trap	4-64
4.3.7.	BMP E3.50: Portable Sediment Tank	4-67
4.3.8.	BMP E3.60: Construction Stormwater Filtration	4-69
4.3.9.	BMP E3.65: Cleaning Inlets and Catch Basins	4-72
4.3.10.	BMP E3.70: Street Sweeping and Vacuuming	4-74
CHAPTER 5 – Source Control Practices for Construction Pollutants Other than Sediment		5-1
5.1.	Source Control Practices	5-1
5.1.1.	BMP C1.15: Material Delivery, Storage, and Containment	5-3
5.1.2.	BMP C1.20: Use of Chemicals During Construction	5-5
5.1.3.	BMP C1.25: Demolition of Buildings	5-7
5.1.4.	BMP C1.30: Building Repair, Remodeling, and Construction	5-8
5.1.5.	BMP C1.35: Sawcutting and Paving Pollution Prevention	5-10
5.1.6.	BMP C1.40: Temporary Dewatering	5-12
5.1.7.	BMP C1.45: Solid Waste Handling and Disposal	5-17
5.1.8.	BMP C1.50: Disposal of Asbestos and Polychlorinated Biphenyls (PCBs)	5-21
5.1.9.	BMP C1.55: Airborne Debris Curtain	5-22
5.1.10.	BMP C1.56: Concrete Handling	5-24
5.1.11.	BMP C1.58: Concrete Washout Area	5-28
5.1.12.	BMP C1.59: High pH Neutralization Using CO ₂	5-33

Tables

Table 1a.	Checklist to Select Small Project Construction BMPs.	3-2
Table 1b.	Checklist to Select Large Project Construction BMPs.	3-11
Table 2.	Temporary Erosion Control Seeding Mixture.	4-5
Table 3.	Guide to Mulch Materials, Rates and Uses.	4-7
Table 4.	Permanent Seeding Mixture.	4-20

Table 5.	Design Criteria for Earth Dike.....	4-47
Table 6.	Design Criteria for Drainage Swale.....	4-47
Table 7.	Geotextile Standards.....	4-51
Table 8.	Vegetated Strip Implementation Criteria.....	4-59
Table 9.	Handling, Hauling, and Destination Requirements for Targeted Materials.	5-19

Figures

Figure 1.	Hydroseeding Method.....	4-3
Figure 2a.	Mat Installation on Slope.....	4-9
Figure 2b.	Mat Installation on a Channel.....	4-10
Figure 3.	Stockpile Covered with Plastic Sheeting.....	4-11
Figure 4.	Preserving Vegetation.....	4-14
Figure 5.	Vegetated Buffer Zone.....	4-17
Figure 6.	Stabilized Construction Access.....	4-27
Figure 7.	Stabilized Construction Access.....	4-28
Figure 8.	Tire Wash Details.....	4-31
Figure 9.	Check Dams.....	4-35
Figure 10.	Triangular Silt Dike Cut Section.....	4-37
Figure 11.	Using a Water Truck for Dust Control.....	4-39
Figure 12.	Earth Dike and Drainage Swale.....	4-45
Figure 13.	Filter Fence Installed on a Slope.....	4-49
Figure 14.	Filter Fence Details.....	4-52
Figure 15.	Block and Gravel Curb Inlet Protection.....	4-55
Figure 16.	Curb and Gutter Barrier.....	4-56
Figure 17.	Straw Wattles or Compost Sock for Inlet Protection.....	4-60
Figure 18.	Straw Wattle Details.....	4-62
Figure 19.	Cross Section of Sediment Trap and Outlet.....	4-66
Figure 20.	Concrete Washout Facility.....	5-30
Figure 21.	Prefabricated Concrete Washout Container with Ramp.....	5-31

CHAPTER 1 – INTRODUCTION

1.1. What is the Purpose of this Volume?

This volume is designed to help businesses, individuals, responsible parties, and public agencies in Seattle implement best management practices (BMPs) at project sites to:

- Prevent impacts to the public drainage system or public combined sewer and downstream resources
- Stop pollutants from contaminating stormwater

Uncontrolled stormwater can threaten downstream resources, such as public storm drains, real property, and natural habitat. It can also pollute our public drainage system or public combined sewer and receiving waters (e.g., creeks, streams, rivers, lakes, and Puget Sound). The resulting impacts can pose serious risks to the health, safety, and welfare of humans and the environment.

1.2. How Does this Volume Apply to Construction?

This volume applies to all construction projects in Seattle, defined in the Seattle Municipal Code (SMC), Chapter 22.801.170 as the addition or replacement of hard surface or the undertaking of land-disturbing activity.

The construction stormwater BMPs and requirements in this volume have been integrated from many programs and regulations, including the provisions of the:

- Federal Clean Water Act
- Federal Coastal Zone Management Act
- City of Seattle Phase I NPDES Municipal Stormwater Permit
- Puget Sound Partnership Action Agenda
- Washington State Department of Ecology (Ecology) Construction Stormwater General Permit
- City of Seattle Stormwater Code

1.2.1. *City of Seattle Requirements*

Under current City law, the responsible party is liable for water quality problems and impacts to downstream resources caused by construction work. Many construction projects with land disturbance require a permit from the Seattle Department of Construction and Inspections (SDCI) and most projects that occur in the street right-of-way require a permit from Seattle Department of Transportation (SDOT). Regardless of whether or not a permit is required, all construction stormwater must be controlled to prevent negative impacts.

If you are planning a construction project and need information concerning the applicable stormwater requirements, the first step is reviewing *Volume 1 – Project Minimum Requirements* and the applicable elements of the Stormwater Code. Code sections to refer to include, but are not limited to, SMC 22.805.020 (particularly subsection D), SMC 22.807.020 (for requirements related to drainage control review), and the definitions in SMC 22.801.

1.2.2. *How to Use This Volume*

- *Chapter 1* (this chapter) outlines the purpose and content of this volume.
- *Chapter 2* provides Construction Stormwater ~~and Erosion~~-Control [and Soil Management Plan](#) requirements.
- *Chapter 3* provides an explanation for BMP selection based on project category and required BMPs.
- *Chapters 4 and 5* provide the standards and specifications for the BMPs contained in this volume.

Several appendices also support the information contained in this manual. These appendices include:

- *Appendix A* – Definitions
- ~~*Appendix B* – Background Information on Chemical Treatment~~
- *Appendix E* – Additional Design Requirements and Plant Lists
- *Appendix F* – Hydrologic Analysis and Design

1.3. What is Considered “Compliance”?

The City expects that the selection and implementation of appropriate BMPs outlined in this volume, and other applicable manuals, will result in compliance with the Stormwater Code’s minimum requirements for project site stormwater pollution prevention control. If compliance is not achieved, additional measures must be implemented.

Proper implementation and maintenance of appropriate BMPs is critical to control any adverse water quality or downstream resource impacts from construction activity.

1.3.1. *Surface Water Quality*

Pollutants that might be expected in the discharge from project sites include, but are not limited to, sediment, pH, and petroleum products. The public drainage system or public combined sewer and/or receiving waters can be contaminated by direct discharges of these pollutants, or from stormwater discharges that have become contaminated by direct contact with the pollutants or pollutants absorbed into sediment.

Soil erosion, sheet erosion, or downstream channel erosion can cause turbid (muddy) stormwater when the sediment contacts rainwater; this is the most common and visible form of construction stormwater pollution. The resulting high turbidity can adversely impact receiving waters if not properly controlled using the BMPs contained in this volume.

The sources of other commonly encountered pollutants include materials and chemicals used during day-to-day construction activities, such as concrete pouring, paving, truck and heavy equipment operation, and maintenance activities. Low and high acidity and petroleum products can adversely impact the public drainage system or public combined sewer and/or receiving waters in more than one way. One direct impact is reduced water quality by introducing pollutants; another impact is decreased function of the public drainage system or public combined sewer by fouling and spreading pollutants in the pipe network.

Ecology's Water Quality Standards for Surface Waters of the State of Washington are provided in the Washington Administrative Code (WAC) Chapter 173-201A. Contractors and other responsible parties must be familiar with the current water quality standards, particularly those targeting typical construction-related pollutants. For more information on surface water quality standards and specific criteria, [contact Ecology at \(425\) 649-7000 or visit refer to Ecology's website \(https://ecology.wa.gov/Water-Shorelines/Water-quality/Water-quality-standards/Criteria\)](https://ecology.wa.gov/Water-Shorelines/Water-quality/Water-quality-standards/Criteria) [www.ecy.wa.gov/programs/wq/swqs/new-rule.html](https://ecology.wa.gov/programs/wq/swqs/new-rule.html).

It is illegal to discharge dirty water to the drainage system; however, the activity may be permitted for disposal in the sanitary sewer if approved by the City and King County.

If sanitary sewer disposal is not available or not allowed, the contaminated water must be treated or transferred to a holding tank, where it must be picked up for offsite disposal.

1.3.2. Groundwater Quality

The Ecology groundwater quality standards are created for protection of groundwater from contamination. The primary water quality consideration for stormwater discharges to groundwater from project sites is the control of contaminants other than sedimentation.

For more information on groundwater quality standards, [contact Ecology at \(425\) 649-7000 or visit refer to Ecology's website \(https://ecology.wa.gov/Water-Shorelines/Water-quality/Groundwater/Groundwater-quality-standards\)](https://ecology.wa.gov/Water-Shorelines/Water-quality/Groundwater/Groundwater-quality-standards) [www.ecy.wa.gov/programs/wq/grndwtr/index.html](https://ecology.wa.gov/programs/wq/grndwtr/index.html).

1.3.3. Downstream Infrastructure and Resources

The public drainage system or public combined sewer, real property, and natural habitat can be adversely impacted when an uncontrolled discharge leaves a project site. Common negative impacts can include soil erosion, flooding, habitat degradation, and/or subsequent destructive after-effects due to increases in the stormwater volume, velocity, and peak flow rate.

The Stormwater Code and this volume may require construction of temporary stormwater retention, detention, or infiltration facilities to protect downstream resources. It is important to note that these facilities must be functioning prior to implementation of land-disturbing activity. If a permanent facility is used to control flows during construction, refer to *Volume 3* for design guidelines and criteria. *Volume 3* also provides design criteria to protect permanent infiltration facilities from siltation during the construction phase of the project. [For most parcel-based projects, the temporary BMPs to be implemented from this volume](#)

[should be sized to accommodate a storm with a 2-year or a 10-year recurrence interval \(refer to specific BMPs for additional guidance regarding sizing\).](#)

Additional impacts to downstream infrastructure and resources can occur from dewatering activities as well. Projects which are required to comply with the Minimum Requirements for Flow Control must include the dewatering discharge volume as part of the total release rate allowed from the site.

1.4. What is Considered “Out of Compliance”?

The Stormwater Code outlines compliance requirements for construction stormwater pollution prevention. If the required BMPs being implemented do not effectively address erosion issues or the discharge of pollutants, additional BMPs may be required.

Violations are enforceable under the City’s Stormwater Code SMC 22.808.030 and *Volume 5 – Enforcement* of this manual.

Examples of when a project would be considered out of compliance with the Stormwater Code include:

- A discharge leaves the project site that causes or contributes to a prohibited discharge, or a known or likely violation of water quality standards in the receiving water, or violates the Phase I NPDES Municipal Stormwater General Permit (SMC, Chapter 22.805.010).
- A project that has not received all required permits and discharges to the public drainage system or public combined sewer.
- A discharge of oil or other deleterious substances leaves the project site and enters the public combined sewer, public drainage system, or receiving waters.
- Sediment is tracked off the project site.
- A project site does not have a Construction Stormwater ~~and Erosion~~-Control [and Soil Management](#) Plan.

This is not a comprehensive list of out of compliance events. If there is a question about compliance, visit the SDCI Applicant Services Center on the 20th floor of the Seattle Municipal Tower, 700 Fifth Avenue, Seattle, Washington 98124, or the [City’s](#) website (www.seattle.gov/sdci~~www.seattle.gov/dpd/~~).

1.5. Purpose of Construction Stormwater Best Management Practices (BMPs)

Construction stormwater BMPs are measures implemented to protect the public drainage system, public combined sewer system, and receiving waters from pollution and impacts to downstream resources during land-disturbing and other construction activities (refer to SMC, Chapter 22.801.030). For example:

- Construction activities such as clearing, grading, excavation, and stockpiling disturb established vegetation, trees, and stable soils.
- Concrete, asphalt, treated timber, and other construction materials involve chemicals and contaminants that must be retained on the project site.
- Construction activities can increase the volume and/or peak flow rate of discharges leaving the site. The discharges can increase sediment, erosion and pollution in receiving waters.
- Construction equipment introduces the potential for spills involving oil, gasoline, or other petroleum products.

In general, construction BMPs help to prevent pollution from leaving the project site, eliminate ponding and/or flooding in the public right-of-way, and minimize impacts to the public drainage system or public combined sewer. These measures fall into two general categories—erosion and sedimentation control and control of pollutants other than sediment.

Erosion and sediment control BMPs can be grouped according to three methods of controlling erosion and sediment.

- Cover practices: temporary or permanent cover designed to stabilize disturbed areas.
- Erosion control practices: physical measures designed and constructed to prevent erosion of project site soils.
- Sediment control practices: prevent eroded soils from leaving the project site by trapping them in a depression, filter, or other barrier.

Pollutants other than sediment are primarily controlled using good “housekeeping” practices and other methods outlined in this volume to reduce the risk of pollutant contact with stormwater or direct discharge to receiving waters.

Refer to *Volume 4 – Source Control*. This volume should be reviewed to ensure that all requirements are being met for each project.

CHAPTER 2 – CONSTRUCTION STORMWATER AND EROSION CONTROL AND SOIL MANAGEMENT PLAN

The Construction Stormwater ~~and Erosion~~ Control and Soil Management Plan applies best management practices (BMPs) that fall within the 19 elements of water quality, air quality, and downstream resource protection and are required by the Stormwater Code (SMC, Chapter 22.805.020.D). These 19 elements (refer to *Volume 1*) cover general water and air quality protection strategies, including:

- Limiting project site impacts
- Protecting the public drainage system, combined and sanitary sewers, and downstream receiving waters
- Preventing erosion and sedimentation
- Managing activities and sources

Project designers must review the applicable elements of SMC 22.805.020.D and ensure the specific requirements under each of the 19 elements in the code are fully addressed by the project site stormwater pollution prevention controls.

2.1. Small Project Construction Stormwater ~~and Erosion~~ Control and Soil Management Plan

For Small Projects (i.e., 5,000 square feet or less of new plus replaced hard surface, or less than 1 acre of land-disturbing activity) the applicant must submit a Construction Stormwater ~~and Erosion~~ Control Plan and ~~Post-Construction~~ Soil Management Plan that demonstrates how the project will cover the required elements by using BMPs contained in this volume.

The first step after reviewing the Stormwater Code requirements is to refer to *Chapter 3*, Table 1a, Checklist to Select Small Project Construction BMPs. Small Projects are required to implement BMPs as dictated by site conditions. If a required element is not applicable, the reason must be justified briefly on the checklist and in detail in the plan narrative.

The next step is to prepare the Small Project Construction Stormwater Control and ~~Erosion~~ Soil Management Control Plan narrative section that describes the project and selected BMPs.

The narrative, and subsequently prepared plan, must include:

- The name, address, and phone number of the owner or contact person
- A north arrow, lot number and plat, address, date, and street name fronting structure
- A description of all existing and proposed structures on the project site
- Construction clearing limits

- The location and size of all streams, swales, and drainage channels on or within 25 feet of the project site that may be impacted by or affect the drainage of the project site to be developed
- A description of all existing stormwater pipes and their diameters and approximate lengths
- The direction and location of stormwater runoff entering and exiting the project site from all adjacent properties (this may be done with topographic contour lines)
- “Point of discharge” labels for all discharges of stormwater, wastewater, etc. that leave the site or will be infiltrated on site
- The types of systems, including On-Site BMPs, that will be used to convey runoff away from the proposed structures, if applicable
- The steps that will be taken to retain native vegetation and minimize hard surfaces to the maximum extent feasible
- The types of wastewater that may be generated during the work and the types of collection or conveyance systems used to manage the waste, including disposal options
- Location(s) where stormwater discharges or is collected from the project site, including individual (point) flow and sheet flow (i.e., overland flow)
- A description of how construction will be phased so that only those areas actively being worked are uncovered
- The construction entrance(s) and egress, as applicable
- Stockpile and excavation locations

Once the narrative has been completed, the plan sheet should be completed. The plan sheet is not required to be prepared by a civil engineer; however, it is required to graphically show the information provided in the narrative, including how BMPs will be implemented.

~~To assist in meeting the plan sheet requirements, SDCI offers a prescriptive plan sheet, which contains illustrations of some of the most effective BMPs required for Small Projects. It is called the “Construction Stormwater Control and Soil Amendment Standard Plan” (CSC/SA Plan) and provides a quick way for the applicant to document erosion control methods, integrate stormwater controls with building plans, and provides a clear field guide for both the applicant and the City. Refer to Chapters 4 and 5 for details on how to implement the BMPs during construction.~~

The [Construction Stormwater Control and Soil Management Plan](#) CSC/SA can be obtained from the [Seattle Department of Construction and Inspections \(SDCI\) Public Resources Center on the 20th floor of the Seattle Municipal Tower, 700 Fifth Avenue, Seattle, Washington 98124, or the web pagesite](#), which has both pdf and CAD formats ([www.seattle.gov/sdci/codes/codes-we-enforce-\(a-z\)/stormwater-codes](http://www.seattle.gov/sdci/codes/codes-we-enforce-(a-z)/stormwater-codes) www.seattle.gov/dpd/codesrules/codes/stormwater/default.htm).

The applicant is responsible for modifying the Construction Stormwater [Control](#) and [Erosion Control](#) [Soil Management](#) Plan whenever directed to by the Inspector, or when there is a change in design, construction, operation, or maintenance at the project site that has, or could have, a significant effect on the discharge of pollutants.

2.2. Large Project Construction Stormwater ~~and Erosion~~ Control and Soil Management Plan

For Large Projects (i.e., over 5,000 square feet of new plus replaced hard surface, or 1 acre and greater of land-disturbing activity), the applicant must submit a Large Project Construction Stormwater ~~and Erosion~~ Control and Soil Management Plan, including narrative and plan sheet(s), that demonstrate how the project will cover the 19 elements by using BMPs contained in this volume.

The first step is to refer to *Chapter 3*, Table 1b, Checklist to Select Large Project Construction BMPs. Large Projects are required to implement BMPs from all 19 elements. If a required element is not applicable, the reason must be justified briefly on the checklist and in detail in the plan narrative. The next step is to prepare the Large Project Construction Stormwater ~~and Erosion~~ Control and Soil Management Plan narrative section and plan sheets that describe the project and selected BMPs. The Large Project Construction Stormwater ~~and Erosion~~ Control and Soil Management Plan includes the same narrative and plan details required for the Small Project Construction Stormwater ~~and Erosion~~ Control and Soil Management Plan (*Section 2.1*) plus additional narrative and plan sheet(s), as applicable.

The Large Project Construction Stormwater ~~and Erosion~~ Control and Soil Management Plan must be prepared by a qualified professional. When the plan includes engineering calculations, it must be stamped and signed by an engineer licensed in the State of Washington.

2.3. Certified Erosion and Sediment Control Lead

2.3.1. Description

A project representative who is a Certified Erosion and Sediment Control Lead (CESCL). The project proponent designates at least one person as the responsible representative in charge of erosion and sediment control and water quality protection. The designated person shall be the CESCL.

2.3.2. Purpose

The purpose of a designated CESCL is to ensure compliance with all city, county, state, and federal erosion and sediment control and water quality requirements.

2.3.3. Conditions Where Practice Applies

A CESCL should be designated and made available on Large Projects. The CESCL must perform all duties and take on all responsibilities listed in this BMP.

2.3.4. Certification Criteria

The training and administrative requirements for a responsible person to be designated as the CESCL are listed below. The CESCL should:

- Have a current certificate proving attendance in an erosion and sediment control (ESC) training course that meets the minimum ESC training and certification requirements established by [the Washington State Department of Ecology \(Ecology\)](#). Ecology maintains a list of ESC training and certification providers [on its website](#) (<https://ecology.wa.gov/Regulations-Permits/Permits-certifications/Certified-erosion-sediment-control> www.ecy.wa.gov/programs/wq/stormwater/).

OR

Be a Certified Professional in Erosion and Sediment Control (CPESC) or have a special inspection by the City; for additional information on the CPESC certification, [go to](#) [refer to the EnvironCert International, Inc., website](#) (www.envirocertintl.org/cpesc/ www.cpesc.net/).

- Certification must remain valid for 3 years.
- The CESCL should have authority to act on behalf of the contractor or developer and should be available, on call, 24 hours per day throughout the period of construction.
- The name, telephone number, fax number, and address of the designated CESCL must be recorded in the Large Project Construction Stormwater ~~and Erosion~~ Control and Soil Management Plan.
- A CESCL may provide inspection and compliance services for multiple construction projects in the same geographic region.

2.3.5. Duties and Responsibilities

The duties and responsibilities of the CESCL should include, but are not limited to the following:

- Maintain all applicable documentation, permits, and plans on site at all times.
- Direct BMP installation, inspection, maintenance, modification, and removal.
- Update all project drawings and plans with changes made.
- Keep daily logs and inspection reports. Inspection reports should include:
 - Inspection date/time.
 - Weather information: general conditions during inspection and approximate amount of precipitation since the last inspection.
 - A summary or list of all BMPs implemented, including observations of all erosion/sediment control structures or practices. The following should be noted:
 - Locations of BMPs inspected
 - Locations of BMPs that need maintenance
 - Locations of BMPs that failed to operate as designed or intended
 - Locations of where additional or different BMPs are required
- Duties relating to temporary dewatering (BMP C1.40)

- Visual monitoring results, including a description of discharged stormwater. The presence of suspended sediment, turbid water, discoloration, and oil sheen should be noted, as applicable.
- Any water quality monitoring performed during inspection
- General comments and notes, including a brief description of any BMP repairs, maintenance or installations made as a result of the inspection
- Facilitate, participate in, and take corrective actions resulting from inspections performed by outside agencies or the owner.

The CESCL is responsible for modifying the Construction Stormwater ~~and Erosion~~ Control ~~and Soil Management~~ Plan whenever there is a change in design, construction, operation, or maintenance at the project site that has, or could have, a significant effect on the discharge of pollutants, or when directed to by the Inspector.

CHAPTER 3 – SELECTING CONSTRUCTION STORMWATER CONTROLS

Projects must implement [best management practices \(BMPs\)](#) from the 19 elements of general water quality and downstream resource protection strategies listed in [SMC, Chapter 22.805.020.D Section 2.1](#). Refer to [Section 2.1](#) and [Section 2.2](#) for a discussion of Small and Large Project Construction Stormwater ~~and Erosion Control~~ [and Soil Management Plans](#), including the level of detail required for submittals.

Tables 1a and 1b present each of the 19 elements and required or recommended BMPs for Small and Large Project plans, respectively. Required BMPs must be implemented throughout construction. If a required element is not applicable, the reason must be justified briefly on the checklist and in detail in the plan narrative. The recommended BMPs are intended to provide further guidance for minimizing potential stormwater pollution resulting from activities. Using these additional BMPs is encouraged. BMPs referenced as “Ecology BMPs” can be found in Volume II of the [Washington State Department of Ecology \(Ecology\) Stormwater Management Manual for Western Washington \(SWMMWW\)](#), ~~2019~~2012 edition, ~~revised in 2014~~.

Refer to Table 1a or 1b and/or the pre-application report (PAR) prepared by the City to identify the appropriate required and recommended BMPs for your project. The Small Project Construction Stormwater ~~and Erosion Control~~ [and Soil Management](#) Plan and the Large Project Construction Stormwater ~~and Erosion Control~~ [and Soil Management](#) Plan should document each selected BMP and its implementation, maintenance, and inspection requirements.

Note: The City may require additional measures beyond what are shown on the approved plan depending on Stormwater Code requirements, construction sequencing, and actual site conditions.

Table 1a. Checklist to Select Small Project Construction BMPs.

Element Number	Required Element	Project Name: _____	
		Small Project ^a (check selection)	If not applicable, describe why in the space below.
1	Mark Clearing Limits and Environmentally Critical Areas	Recommended ^b BMPs: <input type="checkbox"/> E1.30 Preserving Natural Vegetation (refer to <i>Section 4.1.2.1</i>) <input type="checkbox"/> E1.35 Buffer Zones (refer to <i>Section 4.1.2.2</i>) <input type="checkbox"/> E1.50 High-Visibility Fencing (refer to <i>Section 4.2.5</i>)	
2	Retain Top Layer	Required BMP: Within the boundaries of the project site, retain the duff layer, top soil, and native vegetation, if there is any, in an undisturbed state to the maximum extent feasible. If it is not feasible to retain the top layer in place, stockpile on site, cover to prevent erosion, and replace immediately upon completion of ground disturbing activities to the maximum extent feasible.	
3	Establish Construction Access	Required BMP: <input type="checkbox"/> E2.10 Stabilization Construction <u>Entrance-Access</u> (refer to <i>Section 4.2.1.1</i>) Recommended BMPs: <input type="checkbox"/> E2.15 Tire Wash (refer to <i>Section 4.2.1.2</i>) <input type="checkbox"/> E2.20 Construction Road Stabilization (refer to <i>Section 4.2.1.3</i>)	
4	Protect Downstream Properties and Receiving Waters	Recommended BMP: <input type="checkbox"/> Ecology BMP C241 Temporary Sediment Pond (or Basin)	

Table 1a (continued). Checklist to Select Small Project Construction BMPs.

Element Number	Required Element	Project Name: _____	
		Small Project ^a (check selection)	If not applicable, describe why in the space below.
5	Prevent Erosion and Sediment Transport from the Site	Required BMPs – one or more of the following: <input type="checkbox"/> E3.10 Filter Fence (refer to <i>Section 4.3.1</i>) <input type="checkbox"/> E3.20 Gravel Filter Berm (refer to <i>Section 4.3.2</i>) <input type="checkbox"/> E3.30 Vegetated Strip (refer to <i>Section 4.3.4</i>) <input type="checkbox"/> E3.35 Straw Wattles, Compost Socks, and Compost Berms (refer to <i>Section 4.3.5</i>) <input type="checkbox"/> E3.40 Sediment Trap (refer to <i>Section 4.3.6</i>) <input type="checkbox"/> E3.50 Portable Sediment Tank (refer to <i>Section 4.3.7</i>) <input type="checkbox"/> E3.60 Construction Stormwater Filtration (refer to <i>Section 4.3.8</i>) <input type="checkbox"/> Ecology BMP C231 Brush Barrier <input type="checkbox"/> Ecology BMP C241 Temporary Sediment Pond (or Basin) <input type="checkbox"/> Ecology BMP C250 Construction Stormwater Chemical Treatment	
6	Prevent Erosion and Sediment Transport From the Site by Vehicles	Required BMPs – one or more of the following: <input type="checkbox"/> E3.65 Cleaning Inlets and Catch Basins (refer to <i>Section 4.3.9</i>) <input type="checkbox"/> E3.70 Street Sweeping and Vacuuming (refer to <i>Section 4.3.10</i>)	
7	Stabilize Soils	Required BMPs for all exposed soils and stockpiles – one or more of the following: <input type="checkbox"/> E1.10 Temporary Seeding (refer to <i>Section 4.1.1.1</i>) <input type="checkbox"/> E1.15 Mulching, Matting, and Compost Blankets (refer to <i>Section 4.1.1.2</i>) <input type="checkbox"/> E1.20 Clear Plastic Covering (refer to <i>Section 4.1.1.3</i>) <input type="checkbox"/> E1.40 Permanent Seeding and Planting (refer to <i>Section 4.1.2.1</i>) <input type="checkbox"/> E1.45 Sodding (refer to <i>Section 4.1.2.4</i>) <input type="checkbox"/> E2.45 Dust Control (refer to <i>Section 4.2.1.6</i>) <input type="checkbox"/> Ecology BMP C126 Polyacrylamide for Soil Erosion Protection <input type="checkbox"/> Ecology BMP C130 Surface Roughening <input type="checkbox"/> Ecology BMP C131 Gradient Terracing	

Table 1a (continued). Checklist to Select Small Project Construction BMPs.

Element Number	Required Element	Project Name: _____	
		Small Project ^a (check selection)	If not applicable, describe why in the space below.
8	Protect Slopes (refer to the Environmentally Critical Area ordinance [SMC 25.09.180] for additional requirements and development standards for steep slopes)	Required BMPs – one or more of the following: <input type="checkbox"/> Level Spreader (refer to <i>Appendix E</i>) <input type="checkbox"/> E2.35 Check Dams (refer to <i>Section 4.2.1.4</i>) <input type="checkbox"/> E2.40 Triangular Silt Dike (Geotextile-encased Check Dam) (refer to <i>Section 4.2.1.5</i>) <input type="checkbox"/> Pipe Slope Drains (refer to <i>Appendix E</i>) <input type="checkbox"/> E2.70 Subsurface Drains (refer to <i>Section 4.2.3.1</i>) <input type="checkbox"/> E2.80 Earth Dike and Drainage Swale (refer to <i>Section 4.2.3.2</i>) <input type="checkbox"/> Ecology BMP C201 Grass-lined Channels <input type="checkbox"/> Ecology BMP C130 Surface Roughening <input type="checkbox"/> Ecology BMP C131 Gradient Terracing	
9	Protect Storm Drains	Required BMPs: <input type="checkbox"/> E3.25 Storm Drain Inlet Protection (refer to <i>Section 4.3.3</i>) <input type="checkbox"/> E3.65 Cleaning Inlets and Catch Basins (refer to <i>Section 4.3.9</i>) <input type="checkbox"/> E3.70 Street Sweeping and Vacuuming (refer to <i>Section 4.3.10</i>)	
10	Stabilize Channels and Outlets	Recommended BMPs: <input type="checkbox"/> Level Spreader (refer to <i>Appendix E</i>) <input type="checkbox"/> E2.35 Check Dams (refer to <i>Section 4.2.1.4</i>) <input type="checkbox"/> E2.80 Earth Dike and Swale (refer to <i>Section 4.2.3.2</i>) <input type="checkbox"/> Outlet Protection (refer to <i>Appendix E</i>) <input type="checkbox"/> Ecology BMP C201 Grass-lined Channels <input type="checkbox"/> Ecology BMP C202 Channel Lining <input type="checkbox"/> Ecology BMP C203 Water Bars	

Table 1a (continued). Checklist to Select Small Project Construction BMPs.

Element Number	Required Element	Project Name: _____	
		Small Project ^a (check selection)	If not applicable, describe why in the space below.
11	Control Pollutants (also refer to Volume 4 — Source Control)	Required BMPs: <input type="checkbox"/> C1.15 Material Delivery, Storage, and Containment (refer to Section 5.1.1) <input type="checkbox"/> C1.20 Use of Chemicals During Construction (refer to Section 5.1.2) <input type="checkbox"/> C1.25 Demolition of Buildings (refer to Section 5.1.3) <input type="checkbox"/> C1.30 Building Repair, Remodeling, and Construction (refer to Section 5.1.4) <input type="checkbox"/> C1.35 Sawcutting and Surfacing Pollution Prevention (refer to Section 5.1.5) <input type="checkbox"/> C1.45 Solid Waste Handling and Disposal (refer to Section 5.1.7) <input type="checkbox"/> C1.50 Disposal of Asbestos and Polychlorinated Biphenyls (PCBs) (refer to Section 5.1.8) <input type="checkbox"/> C1.55 Airborne Debris Curtain (refer to Section 5.1.9) <input type="checkbox"/> C1.56 Concrete Handling and Disposal (refer to Section 5.1.10) <input type="checkbox"/> C1.58 Concrete Washout Area (refer to Section 5.1.11)	
12	Control Dewatering	Recommended BMP: <input type="checkbox"/> C1.40 Temporary Dewatering (refer to Section 5.1.6)	
13	Maintain BMPs	Required BMP: <input type="checkbox"/> Maintain and repair all temporary and permanent erosion and sediment control BMPs as needed to assure continued performance of their intended function.	
14	Inspect BMPs	Required BMP: <input type="checkbox"/> Inspect, maintain, and repair all BMPs as needed to assure continued performance of their intended function.	

Table 1a (continued). Checklist to Select Small Project Construction BMPs.

Element Number	Required Element	Project Name: _____	
		Small Project ^a (check selection)	If not applicable, describe why in the space below.
15	Execute Construction Stormwater and Erosion Control and Soil Management Plan	<p>Required BMPs:</p> <p>Implement and maintain an updated Construction Stormwater and Erosion Control and Soil Management Plan, beginning with initial land disturbance.</p> <p><input type="checkbox"/> Retain the Small Project Construction Stormwater and Erosion Control and Soil Management Plan on site or within reasonable access to the site. Modify the plan as needed.</p> <p>Coordination with Utilities, Contractors, and Others</p> <p><input type="checkbox"/> The primary project proponent should evaluate, with input from utilities and other contractors, the stormwater management requirements for the entire project, including the utilities, when preparing the Small Project Construction Stormwater and Erosion Control and Soil Management Plan.</p> <p>Project Close-out:</p> <p><input type="checkbox"/> Remove all temporary erosion and sediment control BMPs within 5 business days after final site stabilization is achieved, or after they are no longer needed—whichever is later.</p>	
16	Minimize Open Trenches	<p>Required BMP:</p> <p>In the construction of underground utility lines, where feasible, no more than one hundred fifty (150) feet of trench should be opened at one time, unless soil is replaced within the same working day. Where consistent with safety and space considerations, place excavated material on the uphill side of trenches. Trench dewatering devices should discharge into a sediment trap or sediment pond.</p>	

Table 1a (continued). Checklist to Select Small Project Construction BMPs.

Element Number	Required Element	Project Name: _____	
		Small Project ^a (check selection)	If not applicable, describe why in the space below.
17	Phase the Project	Required BMPs: Construction Phasing <input type="checkbox"/> Phase development projects where feasible in order to prevent soil erosion and, to the maximum extent practicable, the transport of sediment from the site during construction. Seasonal Work Limitations <input type="checkbox"/> From October 31 through April 1, clearing, grading, and other soil disturbing activities will be subject to additional limitations.	
18	Install Flow Control and Water Quality Facilities	<ul style="list-style-type: none"> Refer to <i>Volume 1</i> for applicable minimum requirements and <i>Volume 3</i> for BMP design. 	
19	Protect Stormwater BMPs	General: Protect all stormwater BMPs from sedimentation through installation and maintenance of erosion and sediment control BMPs. Restore the BMPs to their fully functioning condition if they accumulate sediment during construction. Restoring the stormwater BMP must	

<p>19</p>	<p>Protect Stormwater BMPs (continued)</p>	<p>include removal of sediment and any sediment-laden soils, and replacing the removed soils with soils meeting the design specification.</p> <ul style="list-style-type: none"> <input type="checkbox"/> The approved plan sheets provide construction sequencing that protects the infiltration facility during construction. <p>Sediment Control: Protect infiltration BMPs from sedimentation that can clog the facility and reduce infiltration capacity.</p> <ul style="list-style-type: none"> <input type="checkbox"/> Minimize site disturbance at the location of the infiltration BMPs and in up- gradient areas. <input type="checkbox"/> Do not use infiltration BMPs as sediment control facilities. <input type="checkbox"/> Direct all drainage away from the facility location after initial rough grading. <input type="checkbox"/> Flow can be directed away from the facility with temporary diversion swales or other approved protection. <input type="checkbox"/> Do not construct infiltration BMPs until all contributing drainage areas are stabilized with appropriate erosion and sediment control BMPs and to the satisfaction of the engineer. <input type="checkbox"/> Inspect and maintain erosion and sediment control practices on a regular basis. If deposition of sediment occurs in the infiltration area, remove material and scarify the surface to a minimum depth of 3 inches. <input type="checkbox"/> Control erosion and avoid introducing sediment from surrounding land uses onto permeable pavements. Do not allow muddy construction equipment on the base material or pavement. Do not allow sediment-laden runoff onto permeable pavements or base materials. <input type="checkbox"/> Permeable pavement fouled with sediments or no longer passing an initial infiltration test must be cleaned until infiltrating per design or replaced. <p>Compaction Prevention: Soil compaction can lead to a reduction of infiltration rates and facility failure; accordingly, minimizing compaction of the base and sidewalls of the infiltration area is critical.</p> <ul style="list-style-type: none"> <input type="checkbox"/> Before the development site is graded, rope/fence the area of the infiltration BMP to restrict access and flag to prevent soil compaction by heavy equipment and foot traffic. <input type="checkbox"/> Perform excavation with machinery operating adjacent to the infiltration BMP and do not allow heavy equipment with narrow tracks, narrow tires, or large lugged, high pressure tires on the bottom of the infiltration BMP footprint. 	
-----------	--	---	--

Table 1a (continued). Checklist to Select Small Project Construction BMPs.

Element Number	Required Element	Project Name: _____	
		Small Project ^a (check selection)	If not applicable, describe why in the space below.
		<input type="checkbox"/> Protect established completed lawn and landscaped areas from compaction due to construction equipment. <input type="checkbox"/> Do not excavate during wet or saturated conditions.	

^a A small project is defined as one with less than 5,000 square feet of new plus replaced hard surface, and less than 1 acre of land-disturbing activity.

^b Recommended BMPs provide further guidance for minimizing potential stormwater pollution resulting from activities.

Construction Stormwater Pollution Prevention Plan Checklist

Project Number: _____

Review Date: _____

Onsite Inspection Review Date: _____

Construction SWPPP Reviewer: _____

Table 1b. Checklist to Select Large Project Construction BMPs.

Element Number	Required Element	Project Name: _____	
		Large Project ^a (check selection)	If not applicable, describe why in the space below.
1	Mark Clearing Limits and Environmentally Critical Areas	Required BMPs: <input type="checkbox"/> E1.30 Preserving Natural Vegetation (refer to <i>Section 4.1.2.1</i>) <input type="checkbox"/> E1.35 Buffer Zones (refer to <i>Section 4.1.2.2</i>) <input type="checkbox"/> E1.50 High-Visibility Fencing (refer to <i>Section 4.1.2.5</i>)	
2	Retain Top Layer	Required BMP: Within the boundaries of the project site, retain the duff layer, top soil, and native vegetation, if there is any, in an undisturbed state to the maximum extent feasible. If it is not feasible to retain the top layer in place, stockpile on site, cover to prevent erosion, and replace immediately upon completion of the ground disturbing activities to the maximum extent feasible.	
3	Establish Construction Access	Required BMPs: <input type="checkbox"/> E2.10 Stabilized Construction Entrance Access (refer to <i>Section 4.2.1.1</i>) <input type="checkbox"/> E2.15 Tire Wash (refer to <i>Section 4.2.1.2</i>) <input type="checkbox"/> E2.20 Construction Road Stabilization (refer to <i>Section 4.2.1.3</i>)	
4	Protect Downstream Properties and Receiving Waters	Required BMP for contributing area of 3 acres or greater: <input type="checkbox"/> Ecology BMP C241 Temporary Sediment Pond (Temporary Basin)	

Table 1b (continued). Checklist to Select Large Project Construction BMPs.

Element Number	Required Element	Project Name: _____	
		Large Project ^a (check selection)	If not applicable, describe why in the space below.
5	Prevent Erosion and Sediment Transport from the Site	Required BMPs: <input type="checkbox"/> E3.10 Filter Fence (refer to <i>Section 4.3.1</i>) <input type="checkbox"/> Ecology BMP C231 Brush Barrier <input type="checkbox"/> E3.20 Gravel Filter Berm (refer to <i>Section 4.3.2</i>) AND <input type="checkbox"/> E3.40 Sediment Trap (refer to <i>Section 4.3.6</i>) OR <input type="checkbox"/> Ecology BMP C241 Temporary Sediment Pond (Temporary Basin) OR <input type="checkbox"/> E3.50 Portable Sediment Tank (refer to <i>Section 4.3.7</i>) Additional recommended BMPs: <input type="checkbox"/> E3.30 Vegetated Strip (refer to <i>Section 4.3.4</i>) <input type="checkbox"/> E3.35 Straw Wattles, Compost Socks, and Compost Berms (refer to <i>Section 4.3.5</i>) <input type="checkbox"/> E3.60 Construction Stormwater Filtration (refer to <i>Section 4.3.8</i>) <input type="checkbox"/> Ecology BMP C250 Construction Stormwater Chemical Treatment	
6	Prevent Erosion and Sediment Transport From the Site by Vehicles	Required BMPs: <input type="checkbox"/> E3.65 Cleaning Inlets and Catch Basins (refer to <i>Section 4.3.9</i>) <input type="checkbox"/> E3.70 Street Sweeping and Vacuuming (refer to <i>Section 4.3.10</i>)	

Table 1b (continued). Checklist to Select Large Project Construction BMPs.

Element Number	Required Element	Project Name: _____	
		Large Project ^a (check selection)	If not applicable, describe why in the space below.
7	Stabilize Soils	Required BMPs for all exposed soils and stockpiles – one or more of the following: <input type="checkbox"/> E1.10 Temporary Seeding (refer to <i>Section 4.1.1.1</i>) <input type="checkbox"/> E1.15 Mulching, Matting, and Compost Blankets (refer to <i>Section 4.1.1.2</i>) <input type="checkbox"/> E1.20 Clear Plastic Covering (refer to <i>Section 4.1.1.3</i>) <input type="checkbox"/> E1.40 Permanent Seeding and Planting (refer to <i>Section 4.1.2.3</i>) <input type="checkbox"/> E1.45 Sodding (refer to <i>Section 4.1.2.4</i>) <input type="checkbox"/> E2.45 Dust Control (refer to <i>Section 4.2.1.6</i>) <input type="checkbox"/> Ecology BMP C130 Surface Roughening <input type="checkbox"/> Ecology BMP C131 Gradient Terracing <input type="checkbox"/> Ecology BMP C126 Polyacrylamide for Soil Erosion Protection	
8	Protect Slopes (refer to the Environmentally Critical Areas ordinance [SMC 25.09.180] for additional requirements and development standards for steep slopes)	Required BMPs – one or more of the following: <input type="checkbox"/> Level Spreader (refer to <i>Appendix E</i>) <input type="checkbox"/> E2.35 Check Dams (refer to <i>Section 4.2.1.4</i>) <input type="checkbox"/> E2.40 Triangular Silt Dike (Geotextile-encased Check Dam) (refer to <i>Section 4.2.1.5</i>) <input type="checkbox"/> Pipe Slope Drains (refer to <i>Appendix E</i>) <input type="checkbox"/> E2.70 Subsurface Drains (refer to <i>Section 4.2.3.1</i>) <input type="checkbox"/> E2.80 Earth Dike and Drainage Swale (refer to <i>Section 4.2.3.2</i>) <input type="checkbox"/> Ecology BMP C130 Surface Roughening <input type="checkbox"/> Ecology BMP C131 Gradient Terracing <input type="checkbox"/> Ecology BMP C201 Grass-lined Channels	
9	Protect Storm Drains	Required BMPs: <input type="checkbox"/> E3.25 Storm Drain Inlet Protection (refer to <i>Section 4.3.3</i>) <input type="checkbox"/> E3.65 Cleaning Inlets and Catch Basins (refer to <i>Section 4.3.9</i>) <input type="checkbox"/> E3.70 Street Sweeping and Vacuuming (refer to <i>Section 4.3.10</i>)	

Table 1b (continued). Checklist to Select Large Project Construction BMPs.

Element Number	Required Element	Project Name: _____	
		Large Project ^a (check selection)	If not applicable, describe why in the space below.
10	Stabilize Channels and Outlets	Required BMPs – one or more of the following: <input type="checkbox"/> Level Spreader (refer to <i>Appendix E</i>) <input type="checkbox"/> E2.35 Check Dams (refer to <i>Section 4.2.1.4</i>) <input type="checkbox"/> E2.80 Earth Dike and Drainage Swale (refer to <i>Section 4.2.3.2</i>) <input type="checkbox"/> Outlet Protection (refer to <i>Appendix E</i>) <input type="checkbox"/> Ecology BMP C201 Grass-lined Channels <input type="checkbox"/> Ecology BMP C202 Riprap Channel Lining <input type="checkbox"/> Ecology BMP C203 Water Bars	
11	Control Pollutants (also refer to <i>Volume 4 – Source Control</i>)	Required BMPs: <input type="checkbox"/> C1.15 Material Delivery, Storage, and Containment (refer to <i>Section 5.1.1</i>) <input type="checkbox"/> C1.20 Use of Chemicals During Construction (refer to <i>Section 5.1.2</i>) <input type="checkbox"/> C1.25 Demolition of Buildings (refer to <i>Section 5.1.3</i>) <input type="checkbox"/> C1.30 Building Repair, Remodeling, and Construction (refer to <i>Section 5.1.4</i>) <input type="checkbox"/> C1.35 Sawcutting and Surfacing Pollution Prevention (refer to <i>Section 5.1.5</i>) <input type="checkbox"/> C1.45 Solid Waste Handling and Disposal (refer to <i>Section 5.1.7</i>) <input type="checkbox"/> C1.50 Disposal of Asbestos and Polychlorinated Biphenyls (PCBs) (refer to <i>Section 5.1.8</i>) <input type="checkbox"/> C1.55 Airborne Debris Curtain (refer to <i>Section 5.1.9</i>) <input type="checkbox"/> C1.56 Concrete Handling and Disposal (refer to <i>Section 5.1.10</i>) <input type="checkbox"/> C1.58 Concrete Washout Area (refer to <i>Section 5.1.11</i>) <input type="checkbox"/> C1.59 High pH Neutralization Using CO ₂ (refer to <i>Section 5.1.1244</i>)	
12	Control Dewatering	Required BMP: <input type="checkbox"/> C1.40 Temporary Dewatering (refer to <i>Section 5.1.6</i>)	

Table 1b (continued). Checklist to Select Large Project Construction BMPs.

Element Number	Required Element	Project Name: _____	
		Large Project ^a (check selection)	If not applicable, describe why in the space below.
13	Maintain BMPs	Required BMP: <input type="checkbox"/> Maintain and repair all temporary and permanent erosion and sediment control BMPs as needed to assure continued performance of their intended function.	
14	Inspect BMPs	Required BMP: <input type="checkbox"/> Inspect, maintain, and repair all BMPs as needed to assure continued performance of their intended function. <input type="checkbox"/> Certified Erosion and Sediment Control Lead (refer to <i>Section 2.3</i>): For projects over one (1) acre; inspections should be conducted by the Certified Erosion and Sediment Control Lead identified in the Large Project Construction Stormwater and Erosion Control <u>and Soil Management</u> Plan.	
15	Execute Construction Stormwater and Erosion Control <u>and Soil Management</u> Plan	Required BMPs: Implement and maintain an updated Construction Stormwater and Erosion Control <u>and Soil Management</u> Plan beginning with initial land disturbance. <input type="checkbox"/> Retain the Large Project Construction Stormwater and Erosion Control <u>and Soil Management</u> Plan on site or within reasonable access to the site. Modify the plan as needed. Coordination with Utilities, Contractors, and Others <input type="checkbox"/> The primary project proponent should evaluate, with input from utilities and other contractors, the stormwater management requirements for the entire project, including the utilities, when preparing the Small Project Construction Stormwater and Erosion Control <u>and Soil Management</u> Plan. Project Close-out <input type="checkbox"/> Remove all temporary erosion and sediment control BMPs within 5 business days after final site stabilization is achieved, or after they are no longer needed, whichever is later.	

Table 1b (continued). Checklist to Select Large Project Construction BMPs.

Element Number	Required Element	Project Name: _____	
		Large Project ^a (check selection)	If not applicable, describe why in the space below.
16	Minimize Open Trenches	<p>Required BMP:</p> <p>In the construction of underground utility lines, where feasible, no more than one hundred and fifty (150) feet of trench should be opened at one time, unless soil is replaced within the same working day. Where consistent with safety and space considerations, place excavated material on the uphill side of trenches. Trench dewatering devices should discharge into a sediment trap or sediment pond.</p>	
17	Phase the Project	<p>Required BMPs:</p> <p>Construction Phasing</p> <p><input type="checkbox"/> Phase development projects where feasible in order to prevent soil erosion and, to the maximum extent practicable, the transport of sediment from the site during construction.</p> <p>Seasonal Work Limitations</p> <p><input type="checkbox"/> From October 31 through April 1, clearing, grading, and other soil disturbing activities will be subject to additional limitations.</p>	
18	Install Permanent Flow Control and Water Quality Facilities	<ul style="list-style-type: none"> Refer to <i>Volume 1</i> for applicable minimum requirements and <i>Volume 3</i> for BMP design. 	
19	Protect Stormwater BMPs	<p>General: Protect all stormwater BMPs from sedimentation through installation and maintenance of erosion and sediment control BMPs. Restore the BMPs to their fully functioning condition if they accumulate sediment during construction. Restoring the stormwater BMP must include removal of sediment and any sediment-laden soils, and replacing the removed soils with soils meeting the design specification.</p> <p><input type="checkbox"/> The approved plan sheets provide construction sequencing that protects the infiltration facility during construction.</p> <p>Sediment Control: Protect infiltration BMPs from sedimentation that can clog the facility and reduce infiltration capacity.</p> <p><input type="checkbox"/> Minimize site disturbance at the location of the infiltration BMPs and in up-gradient areas.</p> <p><input type="checkbox"/> Do not use infiltration BMPs as sediment control facilities.</p> <p><input type="checkbox"/> Direct all drainage away from the facility location after initial rough grading.</p>	

Table 1b (continued). Checklist to Select Large Project Construction BMPs.

Element Number	Required Element	Project Name: _____	
		Large Project ^a (check selection)	If not applicable, describe why in the space below.
19	Protect Stormwater BMPs (continued)	<input type="checkbox"/> Flow can be directed away from the facility with temporary diversion swales or other approved protection. <input type="checkbox"/> Do not construct infiltration BMPs until all contributing drainage areas are stabilized with appropriate erosion and sediment control BMPs and to the satisfaction of the engineer. <input type="checkbox"/> Inspect and maintain erosion and sediment control practices on a regular basis. If deposition of sediment occurs in the infiltration area, remove material and scarify the surface to a minimum depth of 3 inches. <input type="checkbox"/> Control erosion and avoid introducing sediment from surrounding land uses onto permeable pavements. Do not allow muddy construction equipment on the base material or pavement. Do not allow sediment-laden runoff onto permeable pavements or base materials. <input type="checkbox"/> Permeable pavement fouled with sediments or no longer passing an initial infiltration test must be cleaned until infiltrating per design or replaced. Compaction Prevention: Soil compaction can lead to a reduction of infiltration rates and facility failure; accordingly, minimizing compaction of the base and sidewalls of the infiltration area is critical. <input type="checkbox"/> Before the development site is graded, rope/fence the area of the infiltration BMP to restrict access and flag to prevent soil compaction by heavy equipment and foot traffic. <input type="checkbox"/> Perform excavation with machinery operating adjacent to the infiltration BMP and do not allow heavy equipment with narrow tracks, narrow tires, or large lugged, high pressure tires on the bottom of the infiltration BMP footprint. <input type="checkbox"/> Protect established completed lawn and landscaped areas from compaction due to construction equipment. <input type="checkbox"/> Do not excavate during wet or saturated conditions.	

^a A large project is one with greater than or equal to 5,000 square feet of new plus replaced hard surface, or greater than or equal to 1 acre of land-disturbing activity.

^b Recommended BMPs provide further guidance for minimizing potential stormwater pollution resulting from activities.

Construction Stormwater Pollution Prevention Plan Checklist

Project Number: _____

Review Date: _____

Onsite Inspection Review Date: _____

Construction SWPPP Reviewer: _____

CHAPTER 4 – STANDARDS AND SPECIFICATIONS FOR CONSTRUCTION EROSION AND SEDIMENTATION CONTROL

This chapter contains the standards and specifications for erosion and sediment control practices that form the backbone of erosion and sediment control planning in [the City of Seattle \(City\)](#). These [best management practices \(BMPs\)](#) are grouped according to their method of controlling erosion and sedimentation at project sites:

- Cover Practices (*Section 4.1*)
- Erosion Control Practices (*Section 4.2*)
- Sediment Control Practices (*Section 4.3*)

Refer to these sections for a list of BMPs in each category.

All temporary erosion and sediment control BMPs must be removed within 5 business days after final site stabilization is achieved, or after they are no longer needed, whichever is later. In either case, trapped sediment must be removed or stabilized on site and the disturbed areas permanently stabilized.

The standards and specifications for each BMP have been divided into six sections to facilitate the selection process and implementation:

1. Definition
2. Purpose
3. Conditions Where Practice Applies
4. Planning Considerations
5. Design Criteria
6. Maintenance

Note that “Conditions Where Practice Applies” always refers to site conditions. As site conditions change, BMPs must be changed to remain in compliance with the Stormwater Code.

4.1. Cover Practices

The cover BMPs for erosion and sedimentation control can be divided into two categories:

1. Temporary cover practices, such as temporary seeding and clear plastic covering (refer to *Section 4.1.1*)
2. Permanent cover practices, such as sodding and planting (refer to *Section 4.1.2*)

The requirements for maintaining permanent BMPs are included with each description; however, all temporary and permanent erosion and sediment control practices should be maintained and repaired as needed to assure continued performance of their intended function.

4.1.1. Temporary Cover Practices

Temporary cover BMPs are implemented to provide a cover to soils exposed during the life of the project. Soil stockpiles must be stabilized from erosion; protected with sediment trapping measures; and where possible, located away from storm drain inlets, waterways, and drainage channels. From October 1 to April 30, no soils should remain exposed and unworked for more than 2 days. From May 1 to September 30, no soils should remain exposed and unworked for more than 7 days.

More than one BMP may be required for effective protection of steeper slopes or where the soils are more erodible.

The standards and specifications for temporary cover BMPs are described in the sections below and include:

- BMP E1.10: Temporary Seeding (*Section 4.1.1.1*)
- BMP E1.15: Mulching, Matting, and Compost Blankets (*Section 4.1.1.2*)
- BMP E1.20: Clear Plastic Covering (*Section 4.1.1.3*)
- Polyacrylamide for soil erosion protection (refer to [Washington State Department of Ecology](#) [Ecology] BMP C126)

4.1.1.1. *BMP E1.10: Temporary Seeding*

Description

The establishment of temporary vegetative cover on disturbed areas by seeding with appropriate rapidly growing annual plants.

Purpose

To provide temporary soil stabilization by planting grasses and legumes to areas that would remain bare for more than 7 days where permanent cover is not necessary or appropriate (Figure 1).



Figure 1. Hydroseeding Method.

Conditions Where Practice Applies

- Permanent structures are to be installed, or extensive re-grading will occur prior to the establishment of permanent vegetation
- Areas which will not be subjected to heavy wear by construction traffic
- Areas sloping up to 15 percent for 100 feet or less (where temporary seeding is the only BMP used)

Planning Considerations

Sheet erosion, caused by the impact of rain on bare soil, is the source of most fine particles in sediment. To reduce this sediment load in runoff, the soil surface itself should be protected.

The most efficient and economical means of controlling sheet and rill erosion is to establish vegetative cover. Annual plants that sprout rapidly and survive for only one growing season are suitable for establishing temporary vegetative cover. Temporary seeding is effective when combined with construction phasing so that bare areas of the site are minimized at all times.

Temporary seeding may prevent costly maintenance operations on other erosion control systems. For example, sediment basin cleanouts will be reduced if the drainage area of a basin is seeded where grading and construction are not taking place. Perimeter dikes will be more effective if not choked with sediment.

Temporary seeding is essential to preserve the integrity of earthen structures used to control sediment, such as dikes, diversions, and the banks and dams of sediment basins.

Proper seedbed preparation and the use of quality seed are important in this practice just as in permanent seeding. Failure to carefully follow sound agronomic recommendations will often result in an inadequate stand of vegetation that provides little or no erosion control.

Design Criteria

- **Time of Seeding:** Seeding should preferably be done between April 1 and June 30, and September 1 through October 31. If seeding is done in the months of July and August, irrigation will be required until 75 percent grass cover is established. If seeding is done between October 1 and March 31, mulch immediately after seeding.
- **Site Preparation:** Before seeding, install needed surface runoff control measures such as gradient terraces, earth dike/drainage swales, level spreaders, and sediment basins.
- **Seedbed Preparation:** The seedbed should be firm with a fairly fine surface. All soil should be roughened no matter what the slope. If compaction is required for engineering purposes, slopes must be track walked before seeding. Perform all cultivating operations across or at right angles to the slope. A minimum of 2 to 4 inches of tilled topsoil is required.
- **Fertilization:** Apply fertilizers as per suppliers and/or Natural Resources Conservation Service (NRCS) recommendations, or apply a 10:4:6 ratio of nitrogen-phosphorus-potassium (N-P-K) fertilizer at a rate of 90 pounds per acre. Developments adjacent to receiving waters must use non-phosphorus fertilizer.
- **Seeding:** Seeding mixtures will vary depending on the exact location, soil type, slope, etc. Information on mixes may be obtained from local suppliers, the Washington State Department of Transportation, or the NRCS. The seed mix in Table 2 is supplied as guidance. Hydroseed applications should include a minimum of 1,500 pounds per acre of mulch with 3 percent tackifier.
- **Mulching:** Mulch is required for seeding. Mulch can be applied on top of the seed or simultaneously by hydroseeding. Refer to BMP 1.15 Mulching, Matting, and Compost Blankets for more information on mulching.
- **Tackifier:** Apply a tackifier with a tracer to indicate where the seeding has been applied.

Table 2. Temporary Erosion Control Seeding Mixture.^a

Name	Proportion by Weight
Turf-type perennial rye (blend of 3 approved varieties) ^b	50 percent
Creeping red fescue ^b	20 percent
Chewings fescue ^b	20 percent
Hard fescue	10 percent

^a Hydroseeding applications with approved seed-mulch-fertilizer mixtures may also be used. Mixture must be no less than 98 percent pure and have a minimum germination rate of 90 percent.

^b Refer to City of Seattle Standard Specification 9-14.2(1) for approved varieties.

Maintenance

- Seeding should be supplied with adequate moisture. Supply water as needed, especially in abnormally hot or dry weather or on adverse sites. Water application rates should be controlled to prevent runoff.
- Re-seed areas which fail to establish at least 80 percent vegetative cover as soon as such areas are identified. If re-seeding is ineffective, use an alternate method, such as sodding, mulching, or nets/mats.
- If vegetative cover is inadequate to prevent rill erosion, apply other BMPs.

4.1.1.2. *BMP E1.15: Mulching, Matting, and Compost Blankets*

Description

Application of plant residues or other suitable materials to the soil surface.

Purpose

To provide immediate protection to exposed soils during the period of short construction delays or over winter months through the application of plant residues, or other suitable materials, to exposed soil areas.

Mulches also enhance plant establishment by conserving moisture and moderating soil temperatures. Mulch helps hold fertilizer, seed, and topsoil in place in the presence of wind, rain, and runoff and maintains moisture near the soil surface.

Conditions Where Practice Applies

- Areas that cannot be seeded because of the season, or are otherwise unfavorable for plant growth
- Areas that have been seeded as specified in Temporary Seeding (BMP E1.10)
- In an area of greater than 25 percent slope, mulching should immediately follow seeding.

Planning Considerations

Mulches are applied to the soil surface to conserve a desirable soil property or to promote plant growth. Surface mulch is one of the most effective means of controlling runoff and erosion on disturbed land (refer to Table 3 for a comparison of pollutant loading reductions for various mulches).

Mulches can increase the infiltration rate of the soil, reduce soil moisture loss by evaporation, prevent crusting and sealing of the soil surface, modify soil temperatures, and provide a suitable microclimate for seed germination.

Organic mulch materials, such as compost, straw, wood chips, bark, and wood fiber, have been found to be the most effective. Compost has the advantage of being reusable by tilling it in to meet the City's soil amendment requirement at the end of the project. A variety of nets and mats have been developed for erosion control in recent years, and these are also used as mulches, particularly in critical areas such as waterways. They may be used to hold other mulches to the soil surface.

The choice of materials for mulching will be based on the type of soil to be protected, site conditions, season, and economics. It is especially important to mulch liberally in mid-summer and prior to winter, and on cut slopes and southern slope exposures.

Table 3. Guide to Mulch Materials, Rates and Uses.

Mulch Material	Quality Standards	Application Depth	Remarks ^a
Gravel, slag or crushed rock	<ul style="list-style-type: none"> ● Washed ● 0.75 to 1.5 inch size 	3 inches	<ul style="list-style-type: none"> ● Excellent mulch for short slopes and around woody plants and ornamentals. ● Use where subject to foot traffic. Approximately 2,000 pounds per cubic yard.
Straw	<ul style="list-style-type: none"> ● Air dried ● Free from unwanted seeds and coarse material 	Minimum 2 inches	<ul style="list-style-type: none"> ● Use for immediate protection. Hand application generally requires greater thickness than blown straw. ● Thickness of straw may be reduced by half when used in conjunction with seeding. ● Most common and widely used mulching material. Can be used in critical erosion areas.
Wood fiber cellulose (partially digested wood fibers)	<ul style="list-style-type: none"> ● Should not contain growth-inhibiting factors 	Minimum 2 inches	<ul style="list-style-type: none"> ● If used on critical areas, double normal application rate. ● Apply with a hydro-mulcher with seed and tackifier. No tie-down required. ● Fibers should be less than 0.75-inch; packaged in 100-pound bags. ● Recycled cellulose may contain polychlorinated biphenyls (PCBs); products should be evaluated for PCBs prior to use.
Compost blanket, mulch, and compost	<ul style="list-style-type: none"> ● No visible water or dust during handling 	Minimum 2 inches	<ul style="list-style-type: none"> ● Excellent mulch for protecting final grades until landscaping. ● Can be directly seeded or tilled into soil as an amendment. ● A 3-inch layer provides superior protection.
Chipped site vegetation	<ul style="list-style-type: none"> ● Average size should be several inches ● Gradations from fines to 6 inches 	Minimum 2 inches	<ul style="list-style-type: none"> ● Cost-effective way to dispose of clear and grubbing debris. ● Should not be used on slopes above 10 percent. Not recommended within 200 feet of receiving waters.
Wood-based mulch	<ul style="list-style-type: none"> ● No visible water or dust during handling ● Must be purchased from supplier with Solid Waste Handling Permit (unless exempt) 	Minimum 2 inches	<ul style="list-style-type: none"> ● Often called hog (or hogged) fuel or wood straw; and is useful organic matter. ● Typically does not provide any weed seed control. ● Prevent introduction of weed plants or seeds with application.

^a All mulches will provide some degree of (1) erosion control, (2) moisture conservation, (3) weed control, and (4) reduction of soil crusting.

Compost Blankets

Compost for use as a mulch layer (i.e., a compost blanket) should meet the definition of “composted materials,” including contaminant limits, in WAC 173-350-220. Coarsely screened compost (1-inch minus screen) provides superior protection in higher rainfall and on steeper slopes, and may be tilled in later for tree and shrub planting areas. A finer compost (1/2- or 5/8-inch minus screen) may be preferred where it will be tilled in later before planting lawn areas. A 2-inch-thick compost blanket is usually sufficient, but 3 inches provides superior protection.

Compost blankets are a preferred cover practice because they:

- Provide superior ground contact compared to rolled mats
- Are more effective at filtering both sediment and pollutants such as oil
- May be seeded when placed and promote superior seed germination
- Can be reused as compost at the end of the project by tilling it in to meet the City’s Soil Amendment BMP (*Volume 3*)

Chemical Mulches and Soil Binders

The use of synthetic, spray-on materials (except tacking agents used with hydroseeding) is not recommended because they can create impervious surfaces and, possibly, adverse effects on water quality. Research shows that they can cause more erosion than bare exposed soil when used.

Nets and Mats

Used alone, netting does not retain soil moisture or modify soil temperature. It stabilizes the soil surface while grasses are being established, and is useful in grassed drainage channels and on slopes. Light netting may also be used to hold other mulches in place. Its relatively high cost makes it most suitable for small sites.

The most critical part of installing nets and mats is obtaining firm, continuous contact between material and soil. Without such contact, the material is useless and erosion occurs. It is important to use an adequate number of staples and to roll the material after laying it to ensure soil is protected.

Design Criteria

- Site Preparation – Same as Temporary Seeding (BMP E1.10)
- Mulch Materials, Application Rates, and Specifications – refer to Table 3
- Erosion nets and mats may be used on level areas, on slopes (Figure 2a) up to 25 percent, and in channels (Figure 2b). Where soil is highly erodible, nets should only be used in connection with organic mulch such as straw and wood fiber. Jute nets should be heavy, uniform cloth woven of single jute yarn, which if 36 to 48 inches wide should weigh an average of 1.2 pounds per linear yard. It must be so applied that it is in complete contact with the soil. Netting should be securely anchored to the soil

with No. 11 gauge wire staples at least 6 inches long, and overlap 2 inches across and 6 inches down.

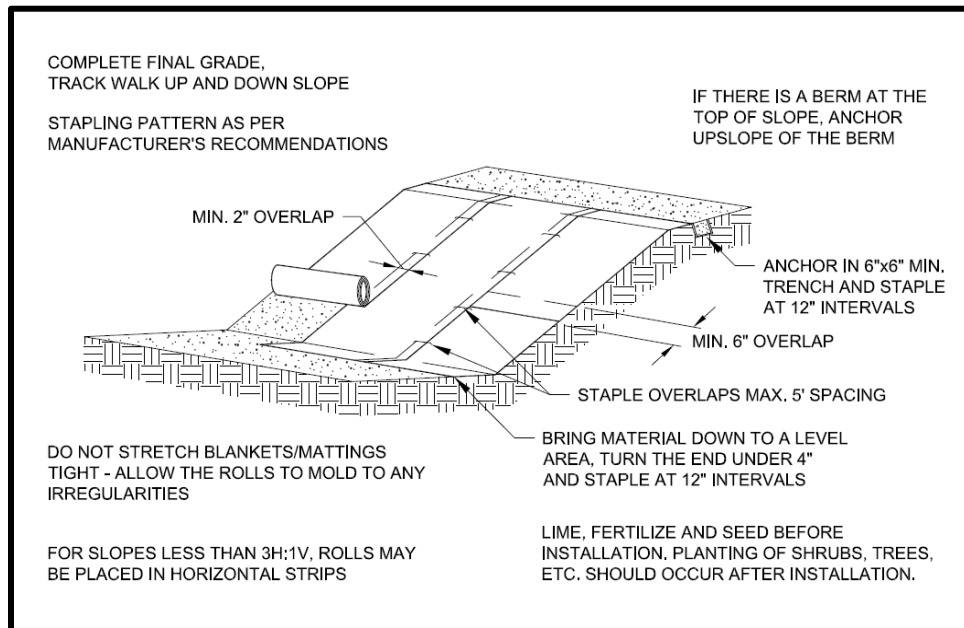

Figure 2a. Mat Installation on Slope.

- To install mats on slopes:
 - First complete the final grade and track walk up and down the slope. Install hydromulch with seed and fertilizer.
 - Dig a small trench, approximately 6 inches wide by 6 inches deep, along the top of the slope.
 - Install the leading edge of the mat into the small trench and staple approximately every 12 inches (metal, U-shaped, and a minimum of 6 inches long). Longer staples should be used in sandy soils. Biodegradable stakes are also available.
 - Roll the mat slowly down the slope as the installer walks backwards, with the mat resting against the installer's legs.
 - Install staples as the mat is unrolled. Do not allow the mat to roll down the slope unattended. Do not allow anyone to walk on the mat after it is in place. If the mat is not long enough to cover the entire slope length, the trailing edge of the upper mat should overlap the leading edge of the lower mat and be stapled.
 - On steeper slopes, this overlap should be installed in a small trench, stapled, and covered with soil.
- Excelsior blankets are considered protective mulches and may be used alone on erodible soils and during all times of year.

Maintenance

Mulched areas should be checked periodically, especially following severe storms. Damaged areas of mulch or tie-down material should be repaired.

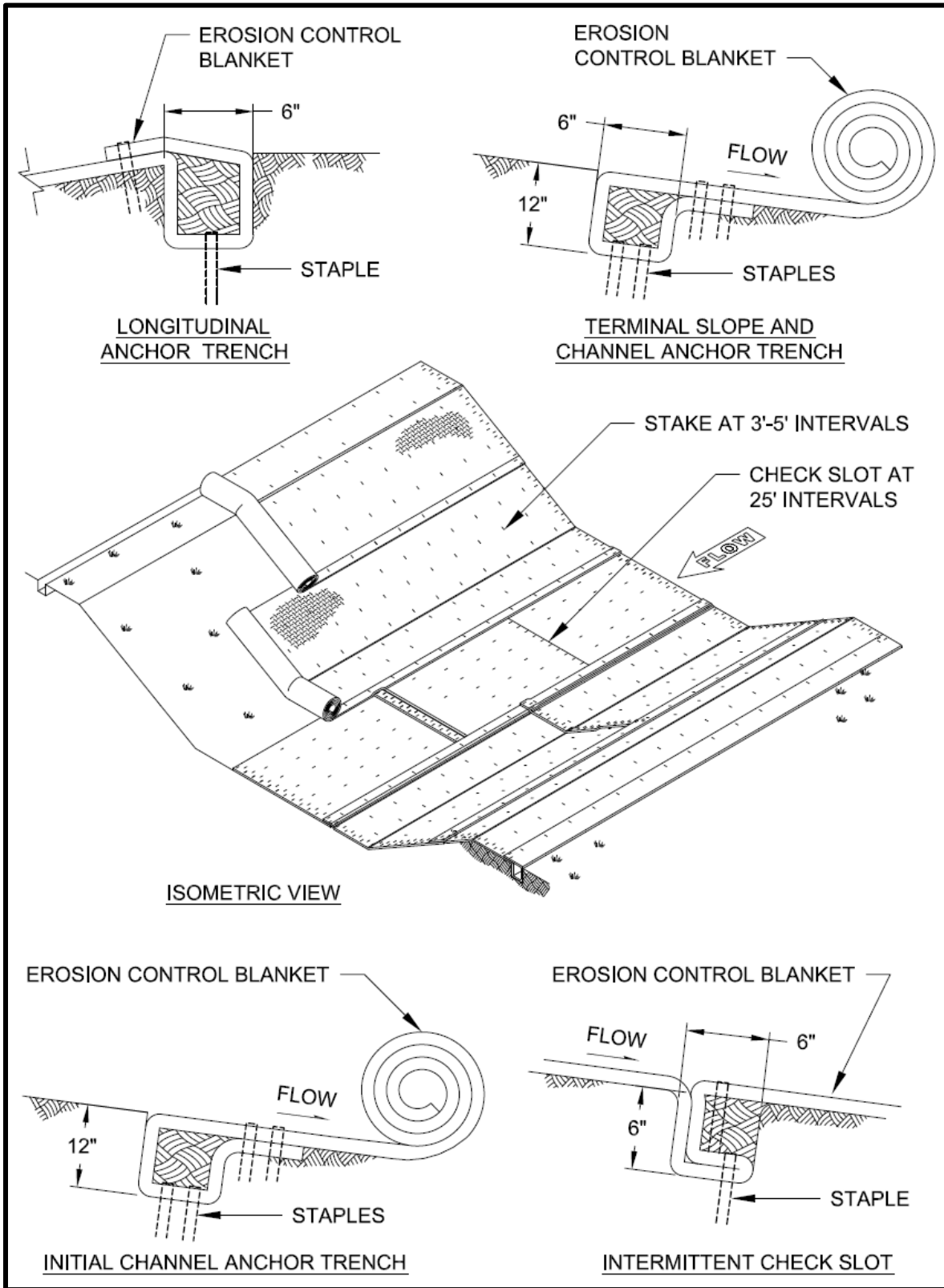

Figure 2b. Mat Installation on a Channel.

4.1.1.3. BMP E1.20: Clear Plastic Covering

Description

The covering with clear plastic sheeting of bare areas that need immediate protection from erosion.

Purpose

To provide immediate temporary erosion protection to slopes and disturbed areas that cannot be covered by mulching, to provide protection to plantings during winter, or to cover stockpiles. Clear plastic also is used to protect disturbed areas that must be covered during short periods of inactivity to meet November 1 through March 31 cover requirements. Because of many disadvantages, clear plastic covering is the least preferred cover practice (Figure 3).

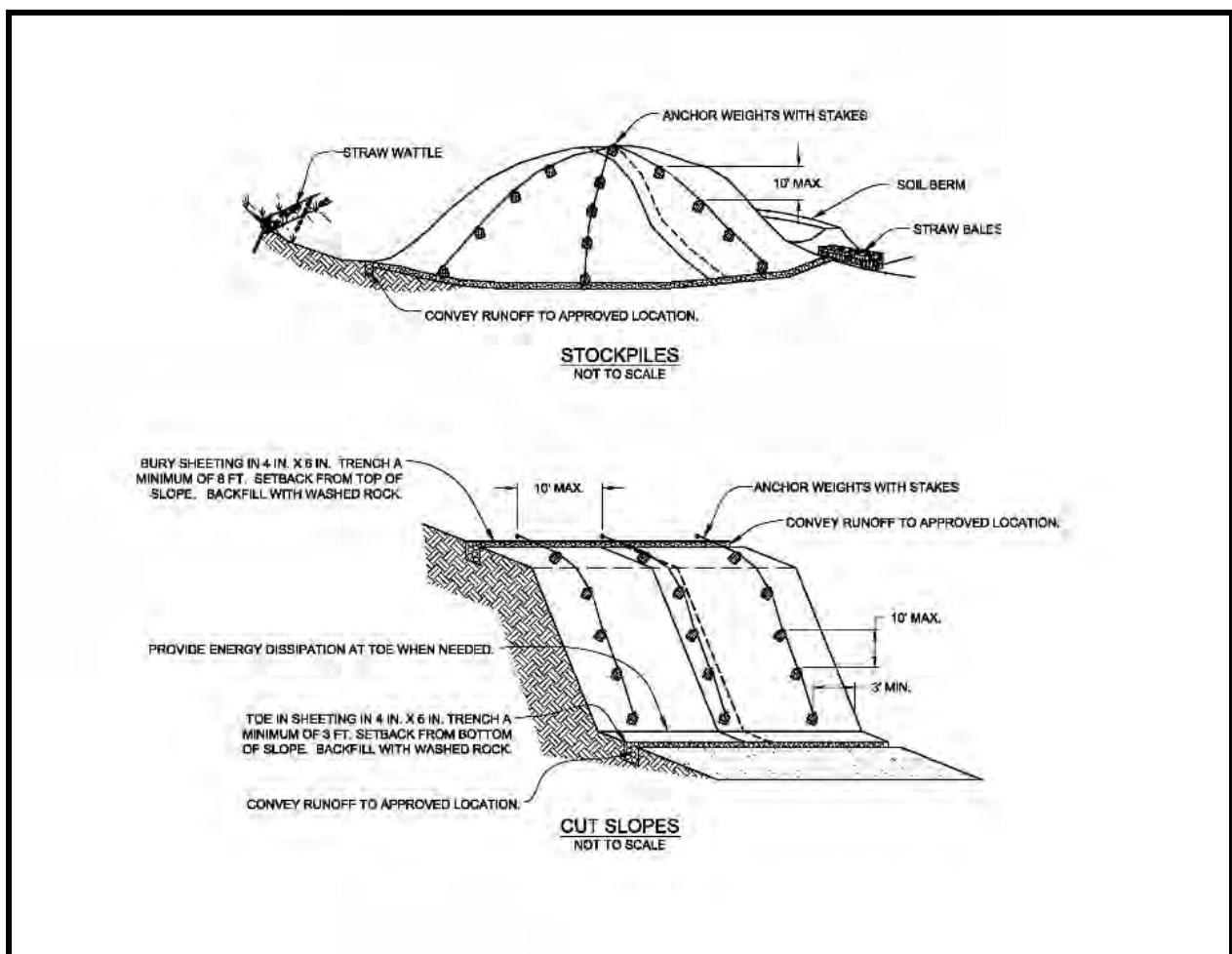

Figure 3. Stockpile Covered with Plastic Sheeting.

Conditions Where Practice Applies

- Disturbed areas that require immediate erosion protection for less than 30 days
- Areas seeded during the time period from November 1 to March 31

Planning Considerations

Plantings at this time require clear plastic covering for germination and protection from heavy rains.

Design Criteria

- Clear plastic sheeting should have a minimum thickness of 6 mil and should meet the requirements of the City of Seattle Standard Specifications Section 9-14.5.
- Place plastic into a small (12-inch wide by 6-inch deep) slot trench at the top of the slope and backfill with soil to keep water from flowing underneath.
- Install covering and maintain tightly in place by using sandbags or tires on ropes with a maximum 10 foot grid spacing in all directions. Tape or weigh down all seams full length with at least a 1- to 2-foot overlap of all seams. Then roll, stake or tie all seams.
- Immediately install covering on areas seeded from November 1 to March 1, and keep covering in place until vegetation is firmly established.
- When the covering is used on unseeded slopes, leave in place until the next seeding period.
- Toe in sheeting at the top of the slope to prevent surface flow beneath the plastic. If erosion at the toe of a slope is likely, install a gravel berm, riprap, or other suitable protection at the toe of the slope in order to reduce the velocity of runoff.
- Remove sheeting as soon as is possible once vegetation is well grown to prevent burning the vegetation through the plastic sheeting, which acts as a greenhouse.
- [Install drainage at the toe of the covered slope to collect and route runoff to the approved discharge point, if needed.](#)

Maintenance

Check regularly for rips and places where the plastic may be dislodged. Contact between the plastic and the ground should always be maintained. Any air bubbles found should be removed immediately or the plastic may rip during the next windy period. Re-anchor or replace the plastic as necessary.

4.1.2. *Permanent Cover Practices*

Permanent cover BMPs are implemented both during and upon completion of construction activities. Permanent cover reduces erosion wherever practicable and can be achieved primarily by limiting site disturbance during construction. For example, by preserving existing conifers approximately 50 percent of all rain that falls onto the trees will be retained during a storm. Up to 20 to 30 percent of this rain may never reach the ground but is taken up by the tree or lost to evaporation. Another benefit of permanent cover is that rain held in permanent vegetation (plantings, grass, trees) can be released slowly into the ground after a rain event.

Note: Equipment access and soil compaction is not allowed in areas where permanent cover is established.

The City requires that all new, replaced, and disturbed topsoil is amended prior to completion of the project. Refer to *Volume 3 – Project Stormwater Control* for guidance on soil amendment BMP requirements.

The standards and specifications for permanent cover BMPs are described below, and include:

- BMP E1.30: Preserving Natural Vegetation (*Section 4.1.2.1*)
- BMP E1.35: Buffer Zones (*Section 4.1.2.2*)
- BMP E1.40: Permanent Seeding and Planting (*Section 4.1.2.3*)
- BMP E1.45: Sodding (*Section 4.1.2.4*)
- BMP E1.50: High-Visibility Fence (*Section 4.1.2.5*)

4.1.2.1. BMP E1.30: Preserving Natural Vegetation

Description

Phase construction activities to minimize exposed soils and consequent erosion by clearing only where construction will occur.

Purpose

To reduce erosion by preserving natural vegetation wherever practicable (Figure 4).

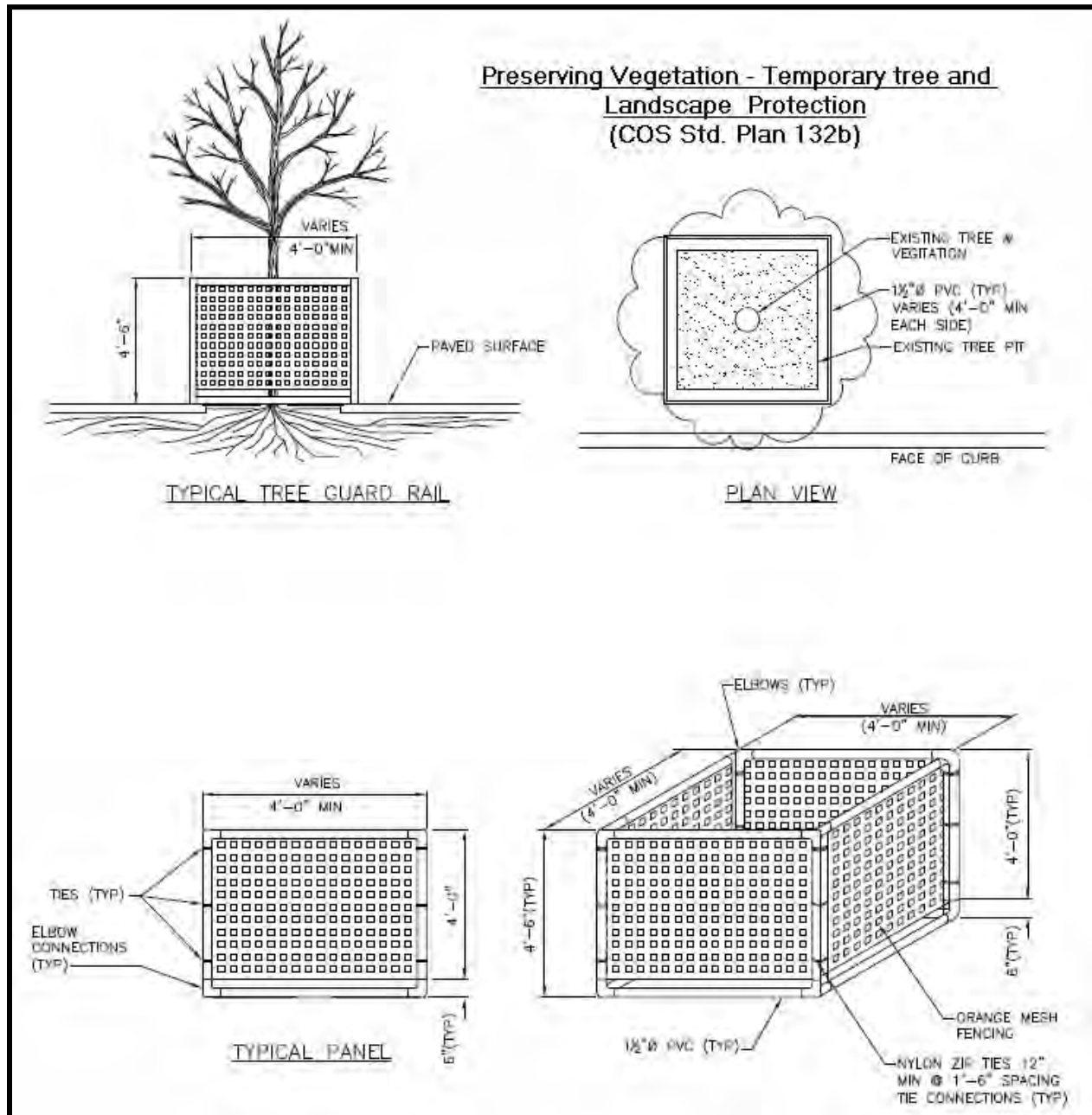

Figure 4. Preserving Vegetation.

Conditions Where Practice Applies

Natural vegetation should be preserved everywhere, and must be preserved with certain Environmentally Critical Areas (ECAs) pursuant to SMC, Chapter 25.09. Natural vegetation should be preserved especially on steep slopes, near perennial and intermittent watercourses or swales, and on building sites in wooded areas.

Planning Considerations

Refer to SMC, Section 25.09 Trees and Vegetation and SMC, Section 25.11 Tree Protection for additional requirements for vegetation and tree protection and requirements within ECAs.

[The Seattle Department of Transportation \(SDOT's\), Urban Forestry section, has additional information regarding vegetation protection on the City's website: \(www.seattle.gov/transportation/projects-and-programs/programs/trees-and-landscaping-program\).](http://www.seattle.gov/transportation/projects-and-programs/programs/trees-and-landscaping-program)

Design Criteria

It can be worthwhile to preserve natural vegetation both in the form of vegetated communities of trees and related understory plants, and in the form of individual trees retained along with the soil that supports them. The preservation of individual trees can be particularly challenging given the typical use of heavy construction equipment on site. Clear field marking is essential to guard against incidental impacts to the soil and or to the trunk, branches, and roots of the tree itself.

Design considerations include:

- Establish a monetary value for the tree or vegetated area and post this in some visible manner on protective fencing to help ensure care on the part of the site contractors. Monetary value is typically established by a professional in the tree care, landscape, and/or nursery industry. This professional should have value assessment experience in accordance with the 9th Edition of the "Guide for Plant Appraisal" (Council of Tree and Landscape Appraisers 2000). An aspect of appraisal includes application of local standards to help ensure the protection of plants that are desirable native or non-native species.
- Prior to beginning land-disturbing activities, including clearing and grading, clearly mark all clearing limits, critical areas, and their buffers. Clearly flag and provide a rigid (chain link or similar) fence to protect areas around trees and vegetated areas to be retained. Where protection of all surfaces within the drip line of the tree or vegetated area is not possible, consult a tree care professional with credentials in urban forestry, landscape architecture, or a related field to develop an appropriate plan. The plan should apply the requirements defined in City of Seattle Standard Plans 132, 133, and 134.
- The duff layer, native top soil, and natural vegetation should be retained in an undisturbed state to the maximum degree practicable.

- Trees and other plants need protection from three types of impacts:
 - Construction Equipment: Impacts can occur above or below the ground level. Damage results from scarring, cutting of roots, and compaction of the soil. Roping or fencing a buffer zone around plants to be saved can prevent such injuries.
 - Grade Change: Any grade change impacting areas within the drip line of an existing tree should be reviewed and approved by a tree care professional with local construction experience. Local experience is needed to ensure familiarity with the tree species and local conditions associated with soil, drainage, and pests or disease that may be factors. Where appropriate, systems may be designed utilizing structural or engineered soil mixes and/or "rootways" to ensure the circulation of air to roots impacted by fill.
 - Excavation: Excavation within the drip line of trees commonly requires exploratory work utilizing hand equipment including the use of an air spade to fracture soil and reveal root locations without damage. Identifying the location of existing roots allows construction to occur within areas where roots are expected with minimal damage to critical root systems.
- For trees required to be preserved, any activities within the drip line requires oversight by a certified arborist or professional. For specific information about preserving mature trees and/or large plants, refer to references listed on the [Seattle Department of Construction and Inspections \(SDCI\) Tree and Landscaping Guidance and Requirements web page](http://www.seattle.gov/sdci/codes/codes-we-enforce-(a-z)/tree-protection-codes) ([www.seattle.gov/sdci/codes/codes-we-enforce-\(a-z\)/tree-protection-codes](http://www.seattle.gov/sdci/codes/codes-we-enforce-(a-z)/tree-protection-codes) www.seattle.gov/dpd/codesrules/codes/treeprotection/default.htm).
- In all situations involving vegetation preservation, it is fundamentally important to involve a qualified tree and/or vegetation care professional to assess the specific site issues. The above guidelines are designed to capture the major common issues associated with vegetation preservation; however, each site will be unique and would benefit from the input of a dedicated professional.

Maintenance

Inspect tree and protection areas regularly to make sure fencing has not been removed. If the fencing has been damaged, repair or replace immediately. If tree roots have been exposed or injured, "prune" cleanly with an appropriate pruning saw or loppers directly above the damaged roots and recover with native soils (with arborist oversight). Mechanical treatment of sap flowing trees (i.e., fir, hemlock, pine, soft maples) is not advised as sap forms a natural healing barrier.

4.1.2.2. *BMP E1.35: Buffer Zones*

Description

An undisturbed area or strip of natural vegetation or an established suitable planting that will provide a living filter to reduce soil erosion and [stormwater](#) runoff velocities.

Purpose

~~Natural Buffer~~ Buffer zones are used along streams and other receiving waters that need protection from erosion and sedimentation (Figure 5).



Figure 5. Vegetated Buffer Zone.

Conditions Where Practice Applies

~~Contractors can use v~~Vegetative buffer zone ~~BMPs can be used~~ to protect natural swales, and ~~they can~~ incorporated ~~them~~ into the natural landscaping of an area. ~~Do not use c~~Critical area buffer zones ~~should not be used~~ as sediment treatment areas; these areas should remain completely undisturbed.

Planning Considerations

The City's ECA regulations require undisturbed vegetative buffer zones from wetlands (SMC, Section 25.09.160), steep slope areas (SMC, Section 25.09.180), and fish and wildlife habitat conservation areas (SMC, Section 25.09.200). Refer to the appropriate code section(s) for site-specific requirements.

Design Criteria

- Preserve natural vegetation or plantings in clumps, blocks, or strips. This is generally the easiest and most successful method.
- Leave all critical areas in a naturally vegetative condition.
- Fence clearing limits and keep all equipment and construction debris out of the natural vegetation.
- Keep all excavations outside of critical areas and the drip line of trees and shrubs.
- Do not push debris or extra soil into the buffer zone area because it will cause damage from burying and smothering.

Maintenance

Inspect the area frequently to make sure flagging remains in place and the area remains undisturbed.

4.1.2.3. *BMP E1.40: Permanent Seeding and Planting*

Description

The establishment of perennial vegetative cover on disturbed areas.

Purpose

- To establish permanent vegetation (i.e., grasses, legumes, trees, and shrubs) as rapidly as possible to prevent soil erosion by wind or water, and to improve wildlife habitat and site aesthetics.
- To provide pollutant filtration (biofiltration) in vegetation-lined channels and to establish constructed wetlands as required.

Conditions Where Practice Applies

- Graded, final graded, or cleared areas where permanent vegetative cover is needed to stabilize the soil
- Areas that will not be brought to final grade for 1 year or more
- Vegetation-lined channels
- Retention or detention ponds as required

Planning Considerations

Vegetation controls erosion by reducing the velocity and the volume of overland flow and protecting the bare soil surface from raindrop impact.

Land that has been disturbed requires vegetative cover. The most common and economical means of establishing this cover is by seeding grasses and legumes.

Advantages of seeding over other means of establishing plants include the small initial establishment cost, the wide variety of grasses and legumes available, low labor requirement, and ease of establishment in difficult areas.

Disadvantages that must be dealt with are the potential for erosion during the establishment stage, a need to reseed areas that fail to establish, limited periods during the year suitable for seeding, and a need for water and appropriate climatic conditions during germination.

Consider the microclimate(s) within the development area. Low areas may have frost pockets and require hardier vegetation since cold air tends to sink and flow towards low spots. South-facing slopes may be more difficult to re-vegetate because they tend to be sunnier and drier.

There are so many variables in plant growth that an end product cannot be guaranteed. Much can be done in the planning stages to increase the chances for successful seeding. Selection of the right plant materials for the site, good seedbed preparation, timing, and conscientious maintenance are important. Whenever possible, native species of plants should be used for landscaping. These plants are already adapted to the locale, and survivability should be higher than with exotic species.

Native species are also less likely to require irrigation. Irrigation can require extensive maintenance, is not cost-effective, and is not an ecologically sound practice.

Design Criteria

- Vegetation cannot be expected to supply an erosion control cover and prevent slippage on a soil that is not stable due to its texture, structure, water movement, or excessive slope.
- Seeding should be done immediately after final shaping, except during the period of November 1 through March 1, when the site should be protected by mulching or plastic covering until the next seeding period. Seeding completed between July 1 and August 30 will require irrigation until 75 percent grass cover is established.
- Permanent vegetation may be in the form of grass-type growth by seeding or sodding, or it may be trees or shrubs, or a combination of these. Establishing this cover may require the use of supplemental materials, such as mulch or jute netting (refer to BMP E1.15).
- Site Preparation: Install temporary surface runoff control measures prior to seeding or planting to protect the surface from erosion until the vegetation is established. Temporary measures include gradient terraces, berms, dikes, level spreaders, drainage channels, and sediment basins.
- Soil Amendments: Soil amendments should be used to achieve organic matter and permeability performance defined in engineered soil/landscape systems. Compost used should meet City of Seattle Standard Specifications 9-14.4(5) or 9-14.4(9). Refer to *Volume 3 – Project Stormwater Control, Section 5.1* for additional requirements regarding soil amendments.
- Seeding Grasses and Legumes: Prepare seedbed. If infertile or coarse textured subsoil will be exposed during land shaping, it is best to stockpile topsoil and re-spread it over the finished slope at a minimum 2- to 6-inch depth and roll it to provide a firm seedbed. If construction fills have left soil exposed with a loose, rough, or irregular surface, smooth with blade and roll. If cuts or construction equipment have left a tightly compacted surface, break with chisel plow or other suitable implement. Perform all cultivating operations across or at right angles to the slope (contoured), such as with cat tracks on the final pass. The seedbed should be firm with a fairly fine surface. All soil should be roughened before seeding. If compaction is required for engineering purposes, slopes must be track walked before seeding.
- Seeding: Apply an appropriate mixture to the prepared seedbed at a rate of 120 pounds/acre. The erosion seeding mixture for application is presented in Table 4.

Table 4. Permanent Seeding Mixture.^a

Name	Percent by Weight
Turf-type perennial rye ^b	50 percent
Creeping red fescue ^b	20 percent
Chewings fescue ^b	20 percent
Hard fescue	10 percent

Notes:

^a Hydroseeding applications with approved seed-mulch-fertilizer mixtures may also be used. Mixture must be no less than 98 percent pure and have a minimum germination rate of 90 percent.

^b Refer to City of Seattle Standard Specification 9-14.2(1) for approved varieties.

- Cover the seed with topsoil or mulch no deeper than 1/2 inch. It is better to work topsoil into the upper soil layer rather than spread a layer of it directly onto the top of the native soil.
- “Hydroseeding” applications with approved seed-mulch-fertilizer mixtures may also be used. Hydroseed applications should include a minimum of 1,500 pounds per acre of mulch with 3 percent tackifier.
- Mulch is always required for seeding. Mulch can be applied on top of the seed or simultaneously by hydroseeding.
- Seeding and planting should be supplied with adequate moisture. Supply water as needed. Water application rates should be controlled to prevent runoff.
- Re-seed and re-plant any areas which fail to establish at least 80 percent cover or experience erosion.
- Control erosion in areas with other BMPs, such as mulching, netting, or matting as necessary to prevent soil loss.
- Wetlands Seed Mixtures: For newly created wetlands, a wetlands specialist should design plantings to provide the best chance of success. Refer to *Volume 3 – Project Stormwater Control* for more information on constructed wetlands.
- Noxious weeds such as reed canary grass (*Phalaris arundinacea*) or purple loosestrife (*Lythrum salicaria*) are not allowed.
- Tree and Shrub Planting: Besides their erosion and sediment control values, trees and shrubs also provide natural beauty and wildlife benefits. When used for the latter, they are usually more effective when planted in clumps or blocks. These procedures should be followed:
 - Trees and shrubs will do best in topsoil. If no topsoil is available, they can be established in subsoil with proper amendment. If trees and shrubs are to be planted in subsoil, particular attention should be paid to amending the soil with generous amounts of organic matter. Mulches should also be used.
 - Good quality planting stock should be used. Normally 1- to 2-year-old deciduous seedlings, and 3- to 4-year-old coniferous transplants, when properly produced and handled are adequate. Stock should be kept cool and moist from time of receipt and planted as soon as possible.
 - Competing vegetation, if significant, should be pulled out of the area where the plant or plants are to be placed.

Maintenance

Inspect seeded areas for failure, make necessary repairs, and re-seed areas with less than 80 percent cover immediately. Conduct a follow-up survey after 1 year and replace failed plants where necessary.

- If vegetative cover is inadequate to prevent rill erosion, apply other BMPs, assuming vegetation was successful.
- If a stand has less than 40 percent cover, re-evaluate choice of plant materials and quantities of lime and fertilizer. Re-establish the stand following recommendations for seedbed preparation and seeding, omitting lime and fertilizer in the absence of soil test results. If the season prevents re-sowing, mulch or jute netting is an effective temporary cover.

4.1.2.4. *BMP E1.45: Sodding*

Description

Stabilizing fine-graded disturbed areas by establishing permanent grass stands with sod.

Purpose

To establish permanent turf for immediate erosion protection or to stabilize drainage channels where concentrated overland flow will occur.

Conditions Where Practice Applies

- Disturbed areas which require immediate vegetative cover
- Drainage channels carrying intermittent flow, where immediate stabilization or aesthetics are factors, and other locations particularly suited to stabilization with sod

Planning Considerations

Sod can initially be more costly than seeding, but the advantages often justify the increased initial costs. Sod provides immediate erosion control and a green surface; however, it must be protected from disturbance while it takes root. Sod is preferable to seed due to the following:

- Reduced failure as compared to seed and the lack of weeds
- Can be established nearly year round
- Immediate protection of the drainage channel after application

Design Criteria

- Shape and smooth the surface to final grade in accordance with the approved grading plan. Over excavate the swale 4 to 6 inches below design elevation to allow room for placing soil amendment and sod.
- Soil amendments should be used to achieve organic matter and permeability performance defined in engineered soil/landscape systems. Compost used should meet City of Seattle Standard Specifications 9-14.4(5) or 9-14.4(9) for Grade A quality compost. Refer to *Volume 3, Section 5.1* for additional requirements regarding soil amendments.
- Add lime to reach a soil pH value of 6.5 (based on soil tests).
- Fertilize according to a soil test or in the absence of a test use available nitrogen, phosphorus and potash as prescribed for permanent seeding. Use fertilizers that are not highly soluble.
- Work lime and fertilizer into the soil 1 to 2 inches deep and smooth the surface.
- Lay strips of sod beginning at the lowest area to be sodded and perpendicular to the direction of water flow. Wedge strips securely in place. Square the ends of each strip to provide for a close, tight fit. Stagger joints at least 12 inches. Staple the upstream edge of each sod strip if installed on slopes steeper than 18 percent.

- Roll the sodded area and irrigate.
- When sodding is carried out in alternating strips, or other patterns, seed the areas between the sod immediately after sodding.
- Sod should be free of weeds and be of uniform thickness (approximately 1 inch) and should have a dense root mat for mechanical strength.

Maintenance

Inspect sodded areas regularly, especially after large storm events. Re-tack, re-sod, or re-seed and protect with a net or mat as necessary.

4.1.2.5. *BMP E1.50: High-Visibility Fence*

Description

Limit access to portions of site not undergoing construction.

Purpose

Fencing is intended to:

- Restrict clearing to approved limits
- Prevent disturbance of sensitive areas, their buffers, and other areas required to be left undisturbed
- Limit construction traffic to designated construction entrances, exits, or internal roads
- Protect areas where marking with survey tape may not provide adequate protection

Conditions Where Practice Applies

To establish clearing limits, plastic, fabric, or metal fence may be used:

- At the boundary of sensitive areas, their buffers, and other areas required to be left uncleared
- As necessary to control vehicle access to and on the site

Design Criteria

- High-visibility plastic fence should be composed of a high-density polyethylene material and should be at least four feet in height. Posts for the fencing should be steel or wood and placed every 6 feet on center (maximum) or as needed to ensure rigidity. The fencing should be fastened to the post every six inches with a polyethylene tie. On long continuous lengths of fencing, a tension wire or rope should be used as a top stringer to prevent sagging between posts. The fence color should be high-visibility orange. The fence tensile strength should be 360 lbs/ft using the ASTM D4595 testing method.
- If appropriate, install fabric [filters](#) fence in accordance with BMP E3.10 to act as a high-visibility fence. [Filter](#) fence should be at least 3 feet high and must be highly visible to meet the requirements of this BMP.
- Metal fences must be designed and installed according to the manufacturer's specifications.
- Metal fences should be at least 3 feet high and must be highly visible.
- Fences should not be wired or stapled to trees.

Maintenance

If the fence has been damaged or visibility reduced, it should be repaired or replaced immediately and visibility restored.

4.2. Erosion Control Practices

Naturally occurring (undisturbed) soil and vegetation provide important stormwater management functions, including:

- Water infiltration
- Nutrient, sediment, and pollutant adsorption
- Sediment and pollutant biofiltration
- Water interflow storage and transmission
- Pollutant decomposition

These functions are largely lost when construction practices erode away native soil and vegetation.

This section presents BMPs that temporarily and permanently address erosion, including measures for project site stabilization, slope protection, and drainage channel protection. The BMPs in this section have been divided into three basic groups based on these characteristics:

1. Temporary erosion control practices, such as road stabilization, check dams, and dust control (beginning at *Section 4.2.1*)
2. Permanent erosion control practices, such as gradient terraces and [riprap](#) channel lining (refer to Ecology's *Stormwater Management Manual for Western Washington [SWMWW]*)
3. Temporary or permanent erosion control practices, such as subsurface drains, earth dikes and drainage swales, and outlet protection (beginning at *Section 4.2.3*)

The requirements for maintaining permanent erosion control BMPs are included with each description; however, all temporary and permanent erosion and sediment control practices should be maintained and repaired as needed to assure continued performance of their intended function.

The City requires that all new, replaced, and disturbed topsoil is amended prior to completion of the project. Refer to *Volume 3 – Project Stormwater Control* for guidance on soil amendment requirements.

Permanent erosion control BMPs may need to be designed by an engineer and may have additional criteria for flow and water quality treatment requirements. Variations or alterations to the minimum BMP requirements typically require an engineer's approval. Refer to *Volume 1* for thresholds and standards.

4.2.1. Temporary Erosion Control BMPs

Although temporary erosion control BMPs are emphasized in this section, they may be combined with permanent control facilities to provide protection of downstream properties during construction. Temporary facilities provide siltation control, but downstream erosion

protection must also be provided. Refer to *Volume 3 – Project Stormwater Control* for flow control requirements.

Temporary cover BMPs are described in the sections below and include:

- BMP E2.10: Stabilized Construction [Entrance Access](#) (*Section 4.2.1.1*)
- BMP E2.15: Tire Wash (*Section 4.2.1.2*)
- BMP E2.20: Construction Road Stabilization (*Section 4.2.1.3*)
- BMP E2.35: Check Dams (*Section 4.2.1.4*)
- BMP E2.40: Triangular Silt Dike (Geotextile-encased Check Dam) (*Section 4.2.1.5*)
- BMP E2.45: Dust Control (*Section 4.2.1.6*)
- Level Spreader – refer to *Appendix E*
- Water Bars – refer to Ecology BMP C203

4.2.1.1. *BMP E2.10: Stabilized Construction EntranceAccess*

Description

A temporary rock-stabilized pad located at all points of vehicular ingress and egress on a construction project or site.

Purpose

To reduce the amount of mud, dirt, rocks, etc. transported onto public roads by motor vehicles or runoff by constructing a stabilized pad of rock spalls at entrances to and exits to and from project sites and washing of tires during egress (Figure 6 and Figure 7).



Figure 6. Stabilized Construction EntranceAccess.



Figure 7. Stabilized Construction [Entrance Access](#).

Conditions Where Practice Applies

Whenever traffic leaves a project site and moves onto a public road or other paved area. Also refer to BMP E3.70 Street Sweeping and Vacuuming.

Planning Considerations

Construction entrances [and exits](#) provide an area where mud can be removed from vehicle tires before they enter a public road. Construction entrances [and exits](#) should be used in conjunction with the stabilization of construction roads to reduce the amount of mud picked up by vehicles. Construction vehicle access and exit should be limited to one route, if possible.

It is important to note that this BMP will only be effective if sediment control is used throughout the rest of the project site.

Design Criteria

- A geotextile should be placed under the spalls to prevent fine sediment from pumping up into the rock pad. The geotextile should meet the standards presented in City of Seattle Standard Specification 9-37.
- Material should be quarry spalls (where feasible), ~~4-inches~~ to 8 inches in size. Do not use crushed concrete, [recycled concrete](#), cement, or calcium chloride for construction [entrance-access](#) stabilization, because these products raise pH levels in stormwater runoff.

[Alternative materials to quarry spalls may be used with increased offsite inspections. For an alternative specification used by the Washington State Department of Transportation \(WSDOT\), refer to BMP C105 Stabilized Construction Access in Volume II of the SWMMWW.](#)

- The rock pad should be at least 12 inches thick and 100 feet in length for sites more than 1 acre; and may be reduced to the maximum practicable size when the size or configuration of the site does not allow the full 100-foot length.
- The access width should be the full width of the vehicle ingress and egress area.
- Additional rock should be added periodically to maintain proper function of the pad.
- Fencing should be installed as necessary to restrict traffic to the construction [entrance-access](#).
- Whenever possible, the [access point entrance](#) should be constructed on level ground with a firm, compacted subgrade. This can substantially increase the effectiveness of the pad and reduce the need for maintenance.

Maintenance

- If the [entrance-access point](#) is not preventing sediment from being tracked onto pavement, then alternative measures are required to keep the streets free of sediment. This may include an increase in the dimensions of the entrance, or the installation of a tire wash (BMP E2.15). Until the entrance is functioning properly, street sweeping may be required.
- Maintain the [entrance-access point](#) in a condition that will prevent tracking or flow of mud onto public rights-of-way. This may require periodic top dressing with 2-inch rock, as conditions demand, and repair and/or cleanout of any structures used to trap sediment. Thoroughly clean all materials spilled, dropped, washed, or tracked from vehicles onto roadways at the end of each day, or more frequently during wet weather.
- Remove any sediment that is tracked onto pavement by shoveling or street sweeping. Remove or stabilize onsite sediment collected by sweeping.
- Street washing is allowed only after sediment is removed in accordance with the above bullet. Do not allow street washwater to enter the public drainage system or systems tributary to waters of the state. All street washwater must be collected and discharged either back onto the site or into the sanitary sewer (if permitted).
- Immediately remove any quarry spalls loosened from the pad that end up on the roadway or sidewalk.

4.2.1.2. *BMP E2.15: Tire Wash*

Description

A system that uses water to wash motor vehicle tires located at points of egress from a project site.

Purpose

A tire wash is used to remove mud, dirt, rocks, etc. from tires and under carriages, and to prevent sediment from being transported onto public roads.

Conditions Where Practice Applies

When a stabilized construction [entrance-access or exit](#) (refer to BMP E2.10) is not preventing sediment from being tracked onto pavement.

Planning Considerations

If approval by King County for wastewater discharge to the sanitary or combined sewer is not obtained, process wastewater can be collected and taken off site to an approved location. Indicate the ultimate discharge point or collection point on the Construction Stormwater ~~and Erosion~~-Control [and Soil Management](#) Plan sheet that clearly identifies the location(s) of stormwater discharges.

Tire washes provide an area where mud can be removed from vehicle tires before they enter a public road. Tire washes and construction [entrances-access points](#) should be used in conjunction with the stabilization of construction roads to reduce the amount of mud picked up by vehicles.

It is important to note that this BMP will only be effective if sediment control is used throughout the rest of the project site.

Design Criteria

- Suggested details are shown in Figure 8. A minimum of 6 inches of asphalt treated base (ATB) over crushed base material or 8 inches over a good subgrade is recommended to pave the tire wash.
- Use a low clearance truck to test the tire wash before paving. Either a belly dump or lowboy will work well to test clearance.
- Keep the water level from 12 to 14 inches deep to avoid damage to truck hubs and filling the truck tongues with water.
- Midpoint spray nozzles are only needed in extremely muddy conditions.
- Tire wash systems should be designed with a small change in grade—6 to 12 inches for a 10-foot wide pond—to allow sediment to flow to the low side of the pond to help prevent re-suspension of sediment. A drain pipe with a 2- to 3-foot riser should be installed on the low side of the pond to allow for easy cleaning and refilling. Polymers may be used to promote coagulation and flocculation in a closed-loop system. Refer to Ecology BMP C126 for additional information on polyacrylamide (PAM) polymers.

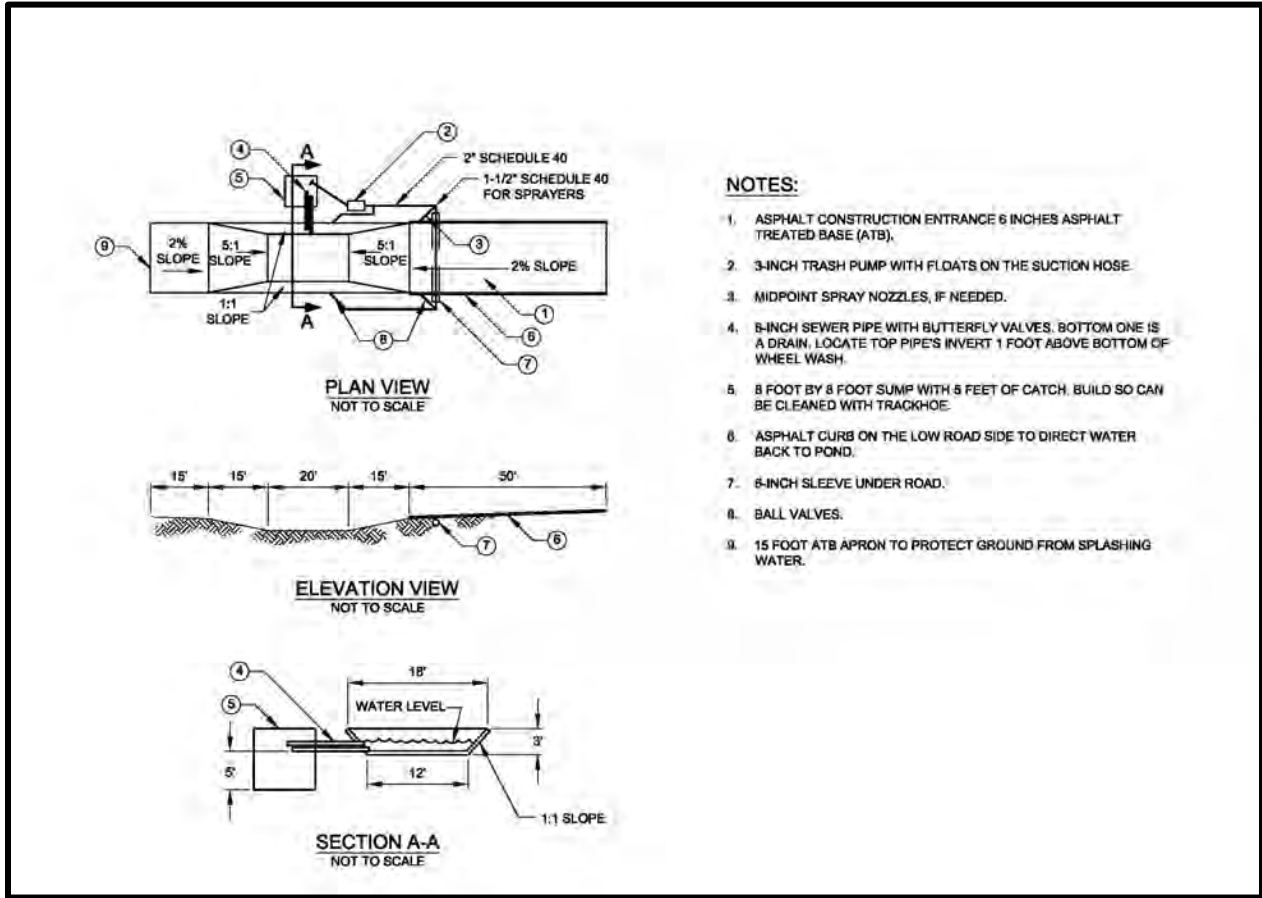

Figure 8. Tire Wash Details.

Maintenance

- The washwater should be changed a minimum of once per day. On large earthwork jobs where more than 10 to 20 trucks per hour are expected, the washwater will need to be changed more often.
- Wheel wash or tire bath wastewater should be discharged to a separate onsite treatment system, that prevents discharge to receiving waters such as closed-loop recirculation or upland land application, or to the sanitary sewer with prior approval by King County.

4.2.1.3. *BMP E2.20: Construction Road Stabilization*

Description

The temporary stabilization with rock on access roads, subdivision roads, parking areas, and other onsite vehicle transportation routes immediately after grading.

Purpose

- To reduce erosion of temporary road beds by construction traffic during wet weather
- To reduce the erosion and therefore re-grading of permanent road beds between the time of initial grading and final stabilization
- To minimize the amount of dirt tracked off site by vehicular traffic

Conditions Where Practice Applies

Wherever rock-base roads or parking areas are constructed, whether permanent or temporary, for use by construction traffic.

Planning Considerations

Areas graded for construction vehicle transport and parking purposes are especially susceptible to erosion. The exposed soil surface is continually disturbed, leaving no opportunity for vegetative stabilization. Such areas also tend to collect and transport runoff waters along their surfaces. During wet weather, they often become muddy quagmires that generate significant quantities of sediment that may pollute nearby streams or be transported off site on the wheels of construction vehicles. Dirt roads can become so unstable during wet weather that they are virtually unusable.

Immediate stabilization of such areas with rock may cost money at the outset, but it may actually save money in the long run by increasing the usefulness of the road during wet weather.

Permanent roads and parking areas should be paved as soon as possible after grading. As an alternative, the early application of rock may solve potential erosion and stability problems and eliminate later re-grading costs. Some of the rock will also probably remain in place for use as part of the final base course of the road.

Design Criteria

- Immediately after grading or the completion of utility installation within the right-of-way, apply a 6-inch course of 2- to 4-inch crushed rock, gravel base, or crushed surfacing base course. A 4-inch course of asphalt treated base (ATB) may be used in lieu of the crushed rock.
- Temporary roads should not exceed 15 percent, should minimize cuts in existing slopes, and be carefully graded to drain transversely. Provide drainage swales to carry flow to a sediment control BMP (*Section 4.3*).
- Protect installed inlets to prevent sediment-laden water entering the drain sewer system (refer to BMP E3.25).

- Maintain undisturbed buffer areas at all stream crossings.
- Seed, mulch, and/or cover areas adjacent to culvert crossings and steep slopes.
- Use dust control when necessary (refer to BMP E2.45).
- If the stabilized construction [entrance-access](#) does not adequately reduce the amount of tracked material, install one or more tire wash BMPs (refer to BMP E2.15).
- Install fencing to limit the access of vehicles to only those roads and parking areas that are stabilized.

Maintenance

- Inspect stabilized areas regularly, especially after large storm events. Add crushed rock if necessary and re-stabilize any areas found to be eroding.

4.2.1.4. *BMP E2.35: Check Dams*

Description

Small dams constructed across a swale or drainage ditch.

Purpose

To reduce the effective slope of the channel and, therefore, the velocity of concentrated flows; reduce erosion of the swale or ditch; and slow water velocity to allow retention of sediments.

Conditions Where Practice Applies

Where temporary channels or permanent channels are not yet vegetated, or [riprap](#) channel lining is infeasible and, therefore, velocity checks are required. Check dams should be placed at regular intervals within constructed channels that are cut down a slope.

Planning Considerations

The City's ECA regulations require protection for high flow refuge habitat for overwintering juvenile salmonids and emergent salmonid fry. Check dams cannot be placed below the expected backwater from any of these areas during specific times of the year. Refer to SMC 25.09 for site-specific requirements.

No check dams may be placed in streams (unless approved by the State Departments of Fisheries or Wildlife as appropriate). Other permits may also be necessary.

Check dams can be constructed of either rock or gravel filled sandbags. If rock check dams are used in grass-lined channels that will be mowed, care should be taken to remove all the rock from the channel when the dam is removed. This should include any rock that has washed downstream.

Design Criteria

- Check dams can be constructed of rock or pea-gravel filled bags. Where high velocity flow is not a concern, compost socks may be used. If necessary, compost socks may be stacked.
- Place check dams should perpendicular to the flow of water.
- The dam should form a triangle when viewed from the side. This prevents undercutting as water flows over the face of the dam rather than falling directly onto the ditch bottom.
- Before installing check dams, impound and bypass upstream flow away from the work area. Options for bypassing include pumps, siphons, or temporary channels.
- Check dams in association with sumps work more effectively at slowing flow and retaining sediment than just a check dam alone. Provide a deep sump immediately upstream of the check dam.

- In some cases, if carefully located and designed, check dams can remain as permanent installations with very minor re-grading. They may be left as either spillways—in which case accumulated sediment would be graded and seeded—or as check dams to prevent further sediment from leaving the site.
- Keep the maximum spacing between the dams such that the toe of the upstream dam is at the same elevation as the top of the downstream dam (Figure 9).

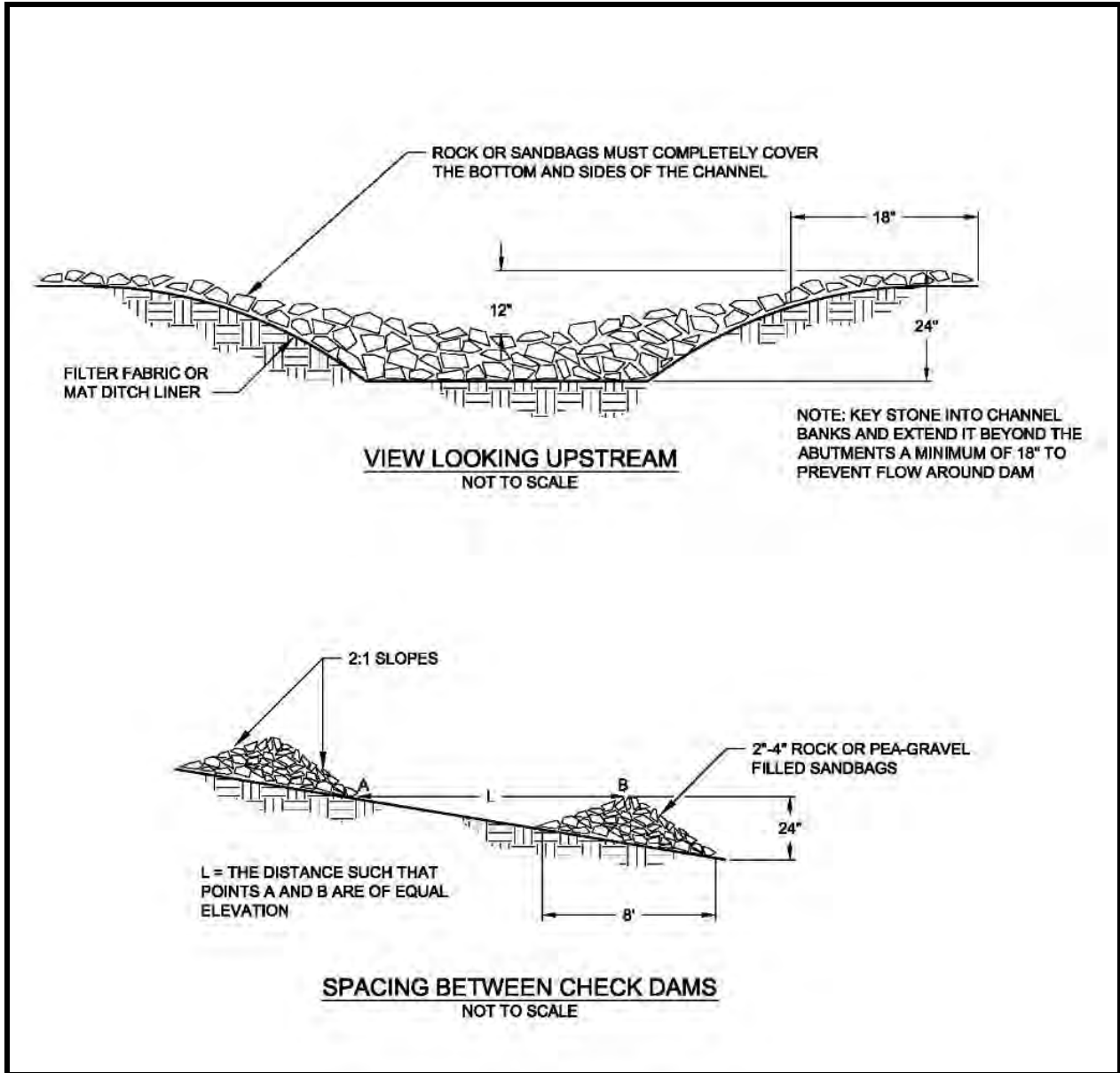

Figure 9. Check Dams.

- Keep the maximum height at 2 feet at the center of the dam.
- Keep the center of the check dam at least 12 inches lower than the outer edges at natural ground elevation.
- Keep the side slopes of the check dam at 2H:1V or flatter.
- Key the rock into the ditch banks and extend it beyond the abutments a minimum of 18 inches to avoid washouts from overflow around the dam.
- Rock check dams should be constructed of appropriately sized rock. The rock used must be large enough to stay in place given the expected design flow through the channel. Place the rock by hand or by mechanical placement (no dumping of rock to form dam) to achieve complete coverage of the ditch or swale and to ensure that the center of the dam is lower than the edges.
- Use filter fabric foundation under a rock or sand bag check dam. This is not necessary if a mat ditch liner is used. A piece of organic or synthetic mat cut to fit will also work for this purpose.
- In the case of grass-lined ditches and swales, remove check dams when the grass has matured sufficiently to protect the ditch or swale, unless the slope of the swale is greater than 4 percent. Immediately after dam removal, seed and mulch the area beneath the check dams.
- Ensure that channel appurtenances, such as culvert entrances below check dams, are not subject to damage or blockage from displaced rocks.

Maintenance

- Monitor check dams for performance and sediment accumulation during and after each runoff producing rainfall. Remove sediment when it reaches one-half the sump depth.
- If significant erosion occurs between dams, install a protective riprap liner in that portion of the channel.

4.2.1.5. *BMP E2.40: Triangular Silt Dike (~~TSD~~Geotextile-encased Check Dam)*

Description

A triangular dike made of urethane foam sewn into a woven geosynthetic fabric.

Purpose

~~Triangular silt dikes (TSDs)~~ may be used as check dams, for perimeter protection, for temporary soil stockpile protection, for drop inlet protection, or as a temporary earth dike (Figure 10).

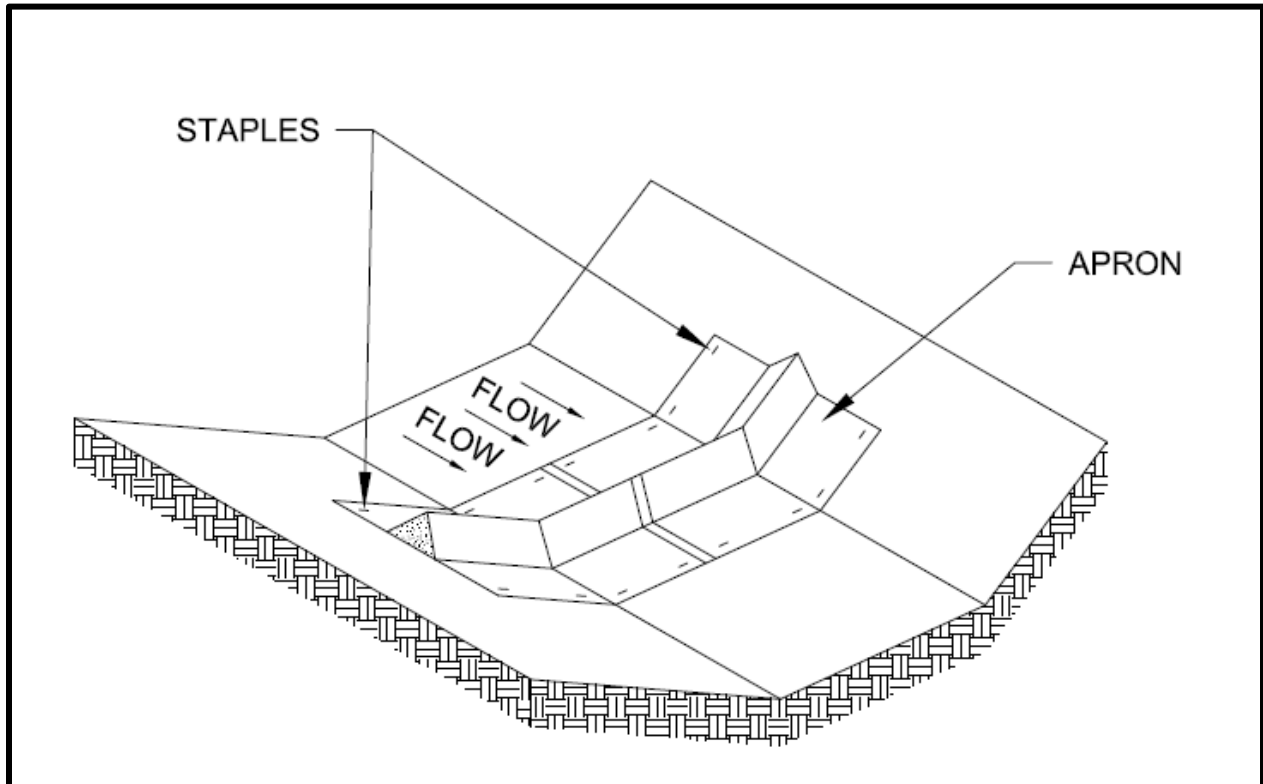

Figure 10. Triangular Silt Dike Cut Section.

Conditions Where Practice Applies

- May be used as temporary check dams in ditches of any dimension
- May be used on soil or pavement with adhesive or staples
- ~~Triangular silt dikes~~TSDs have been used to build temporary:
 - Sediment ponds
 - Diversion ditches
 - Concrete washout facilities
 - Curbing
 - Water bars
 - Level spreaders
 - Berms

Planning Considerations

- When used as check dams:
 - ~~TSDs~~Check dams should be located and installed as soon as construction will allow.
 - ~~TSDs~~Check dams should be placed perpendicular to the flow of water.
 - Anticipate submergence and deposition above the ~~TSD~~triangular silt dam and erosion from high flows around the edges of the dam.

Design Criteria

This BMP is typically made of urethane foam sewn into a woven geosynthetic fabric. It is triangular, 10 inches to 14 inches high in the center, with a 20- to 28-inch base. A 2-foot apron extends beyond both sides of the triangle along its standard section of 7 feet. A sleeve at one end allows attachment of additional sections as needed.

- Install with ends curved up to prevent water from flowing around the ends.
- The fabric flaps and check dam units are attached to the ground with wire staples. Wire staples should be No. 11 gauge wire and should be 200 millimeters (mm) to 300 mm in length.
- When multiple units are installed, the sleeve of fabric at the end of the unit should overlap the abutting unit and be stapled.
- When used as check dams, secure the leading edge with rocks, sandbags, or a small key slot and staples.

Maintenance

- ~~Inspect~~Monitor ~~triangular silt dams~~TSDs for performance and sediment accumulation during and after each ~~runoff-producing~~ rainfall that produces runoff. Remove sediment when it reaches one-half the height of the ~~TSD~~dam.
- In the case of grass-lined ditches and swales, remove check dams and accumulated sediment when the grass has matured sufficiently to protect the ditch or swale, unless the slope of the swale is greater than 4 percent. Seed and mulch the area beneath the check dams immediately after dam removal.
- Immediately repair any damage or any undercutting of the ~~dam~~TSD.

4.2.1.6. *BMP E2.45: Dust Control*

Description

Reducing surface and air movement of dust during land-disturbing, demolition, and construction activities.

Purpose

To prevent surface and air movement of dust from exposed soil surfaces onto roadways, adjoining properties and into drainage channels and receiving waters (Figure 11).



Figure 11. Using a Water Truck for Dust Control.

Conditions Where Practice Applies

In areas (including roadways) subject to surface and air movement of dust where on and offsite damage is likely to occur if preventive measures are not taken.

Planning Considerations

Research at project sites has established an average dust emission rate of 1.2 tons/acre/month for active construction.

Construction activities inevitably result in the exposure and disturbance of soil. Fugitive dust is emitted both during the activities (i.e., excavation, demolition, vehicle traffic, human activity) and as a result of wind erosion over the exposed earth surfaces. Large quantities of dust are typically generated by “heavy” construction activities, such as road and street construction and subdivision, commercial and industrial development, which involve disturbance of significant areas of soil surface. Earthmoving activities are the major source, but traffic and general disturbance of the soil also generate significant dust emissions.

In planning for dust control, remember that the less soil is exposed at any one time, the less potential there will be for dust generation. Therefore, phasing a project and utilizing temporary stabilization practices upon the completion of grading can significantly reduce dust emissions. Also, limit traffic that will be on areas off the site roadways.

Design Criteria

- Minimize the period of soil exposure through use of temporary ground cover and other temporary stabilization practices (refer to Seeding and Mulching, BMPs E1.10 and E1.15, respectively).
- Construct natural or artificial windbreaks or windscreens. These may be designed as enclosures for small dust sources.
- Sprinkle the site with water until surface is wet. Repeat as needed. To prevent carryout of mud onto street, refer to Stabilized Construction [Entrance Access](#) (BMP E2.10) and Tire Wash (BMP E2.15).
- Spray exposed soil areas with approved dust palliative. Oil should not be used for dust suppression. Refer to [Ecology BMP C250 Appendix B](#) for information on chemical treatment.
- Building demolition should use sufficient water, such as from a hydrant or water truck(s), to thoroughly wet buildings and debris for dust suppression and control for water runoff from the site. Repeat as needed. To prevent carryout of mud onto the street, refer to Stabilized Construction [Entrance Access](#) (BMP E2.10) and Tire Wash (BMP E2.15).

Maintenance

Re-spray area as necessary to keep dust to a minimum.

4.2.2. *Permanent Erosion Control BMPs*

Permanent erosion control BMPs are implemented both during and upon completion of construction activities. Permanent erosion control reduces erosion wherever practicable and can be achieved primarily by minimizing erosion by installing permanent stabilizing structures and/or materials to new construction or existing sites. For example, by adding gradient terraces to an existing or newly constructed slope, erosion will be significantly reduced by creating a set of ridges and channels that intercept runoff and direct it to a controlled outlet. The benefit is that rill and gully formation will be minimized and toe of slope erosion will decrease as a result. Another benefit of permanent erosion control is that some of the following BMPs include using vegetation which may be incorporated into permanent cover BMPs described in *Section 4.1.2*.

Permanent erosion control BMPs should be designed by an engineer and may have additional criteria for flow control and water quality treatment requirements. Refer to *Volume 3 – Project Stormwater Control*.

The standards and specifications for permanent erosion control BMPs include:

- [Riprap](#) Channel Lining – refer to Ecology BMP C202
- Gradient Terracing – refer to Ecology BMP C131

4.2.3. Temporary or Permanent Erosion Control BMPs

There is a subset of erosion control BMPs that may be used as temporary controls during construction, then remain as a permanent erosion control measure. For example, an earth dike and drainage swale would provide siltation control during construction, and remain as permanent protection of downstream properties after construction.

Temporary measures that may also remain as a permanent erosion control are typically implemented during construction activities.

The BMPs in this section include:

- BMP E2.70: Subsurface Drains (*Section 4.2.3.1*)
- BMP E2.80: Earth Dike and Drainage Swale (*Section 4.2.3.2*)
- Outlet Protection – refer to *Appendix E*
- Pipe Slope Drains – refer to *Appendix E*
- Surface Roughening – refer to Ecology BMP C130
- Grass-lined Channels – refer to Ecology BMP C201

The requirements for maintaining permanent BMPs are included with each description; however, all temporary and permanent erosion and sediment control practices should be maintained and repaired as needed to assure continued performance of their intended function.

4.2.3.1. *BMP E2.70: Subsurface Drains*

Description

A perforated conduit such as a pipe, tubing, or tile installed beneath the ground to intercept and convey groundwater.

Purpose

To provide a dewatering mechanism for draining excessively wet, sloping soils—usually consisting of an underground-perforated pipe that will intercept and convey groundwater.

Conditions When Practice Applies

Wherever excessive water must be removed from the soil. The soil must be deep and permeable enough to allow an effective system to be installed. This standard does not apply to subsurface drains for building foundations or deep excavations.

Planning Considerations

Subsurface drainage systems are of two types: relief drains and interceptor drains. Relief drains are used either to lower the water table in order to improve the growth of vegetation, or to remove ponded water. They are installed along a slope and drain in the direction of the slope. They can be installed in a gridiron pattern, a herringbone pattern, or a random pattern.

Interceptor drains are used to remove water as it seeps down a slope to prevent the soil from becoming saturated and subject to slippage. They are installed across a slope and drain to the side of the slope. They usually consist of a single pipe or series of single pipes instead of a patterned layout.

Design Criteria

- Temporary measures that may also remain as a permanent erosion control are typically implemented during construction activities. The depth of an interceptor drain is determined primarily by the depth to which the water table is to be lowered or the depth to a confining layer. For practical reasons, the maximum depth is usually limited to 6 feet, with a minimum cover of 2 feet to protect the conduit.
- The soil should have depth and sufficient permeability to permit installation of an effective drainage system at a depth of 2 to 6 feet.
- An adequate outlet for the drainage system must be available either by gravity or by pumping.
- The quantity and quality of discharge needs to consider the ultimate receiving water (additional detention and/or treatment may be required).
- The capacity of an interceptor drain is determined by calculating the maximum rate of groundwater flow to be intercepted. Therefore, it is good practice to make completed subsurface investigations, including hydraulic conductivity of the soil, before designing a subsurface drainage system.

- Subsurface drains are sized for the required capacity without pressure flow. The minimum diameter for a subsurface drain is 4 inches.
- The minimum velocity required to prevent silting is 1.4 feet per second (ft/sec). Grade the line to achieve at least this velocity. The maximum allowable velocity using a sand-gravel filter or envelope is 9 feet per second.
- Use filter material and fabric around all drains for proper bedding and filtration of fine materials. Envelopes and filters should surround the drain to a minimum of 3-inch thickness.
- Install the outlet of the subsurface drain such that it empties into a sediment trap or pond. If free of sediment, it can empty into a receiving water, swale, or stable vegetated area adequately protected from erosion and undermining.
- The strength and durability of the pipe must meet the requirements of the site in accordance with the manufacturer's specifications.
- Secure an animal guard to the outlet end of the pipe to keep out rodents.
- Use outlet pipe of corrugated metal, cast iron, or heavy-duty plastic without perforations and at least 10 feet long. Do not use an envelope or filter material around the outlet pipe, and bury at least two-thirds of the pipe length.
- When outlet velocities exceed those allowable for the receiving water, provide outlet protection.

Construction Specifications

- Construct the trench on a continuous grade with no reverse grades or low spots.
- Stabilize soft or yielding soils under the drain with gravel or other suitable material.
- Do not use deformed, warped, or otherwise unsuitable pipe.
- Place filter material as specified with at least 3 inches of material on all sides of the pipe.
- Backfill immediately after placement of the pipe. Do not allow sections of pipe to remain uncovered overnight or during a rainstorm. Place backfill material in the trench in such a manner that the drain pipe is not displaced or damaged.

Maintenance

- Periodically check subsurface drains to ensure that they are free-flowing and not clogged with sediment.
- Keep the outlet clean and free of debris.
- Keep surface inlets open and free of sediment and other debris.
- Trees located too close to a subsurface drain often clog the system with their roots. If a drain becomes clogged, relocate the drain to minimize this problem. As a last resort, the trees may need to be removed. Tree removal may require prior approval by SDCI and SDOT.
- Where heavy vehicles cross drains, check the line to ensure that it is not crushed.

4.2.3.2. BMP E2.80: Earth Dike and Drainage Swale

Description

A ridge of compacted soil or a swale with vegetative lining located at the top or base of a sloping disturbed area.

Purpose

To intercept stormwater runoff from drainage areas above unprotected slopes and direct it to a stabilized outlet.

Conditions Where Practice Applies

Wherever the volume and velocity of runoff from exposed or disturbed slopes must be reduced. When an earth dike/drainage swale is placed above a disturbed slope, it reduces the volume of water reaching the disturbed area by intercepting runoff from above (Figure 12). When it is placed horizontally across a disturbed slope, it reduces the velocity of runoff flowing down the slope by reducing the distance that the runoff can flow downhill.

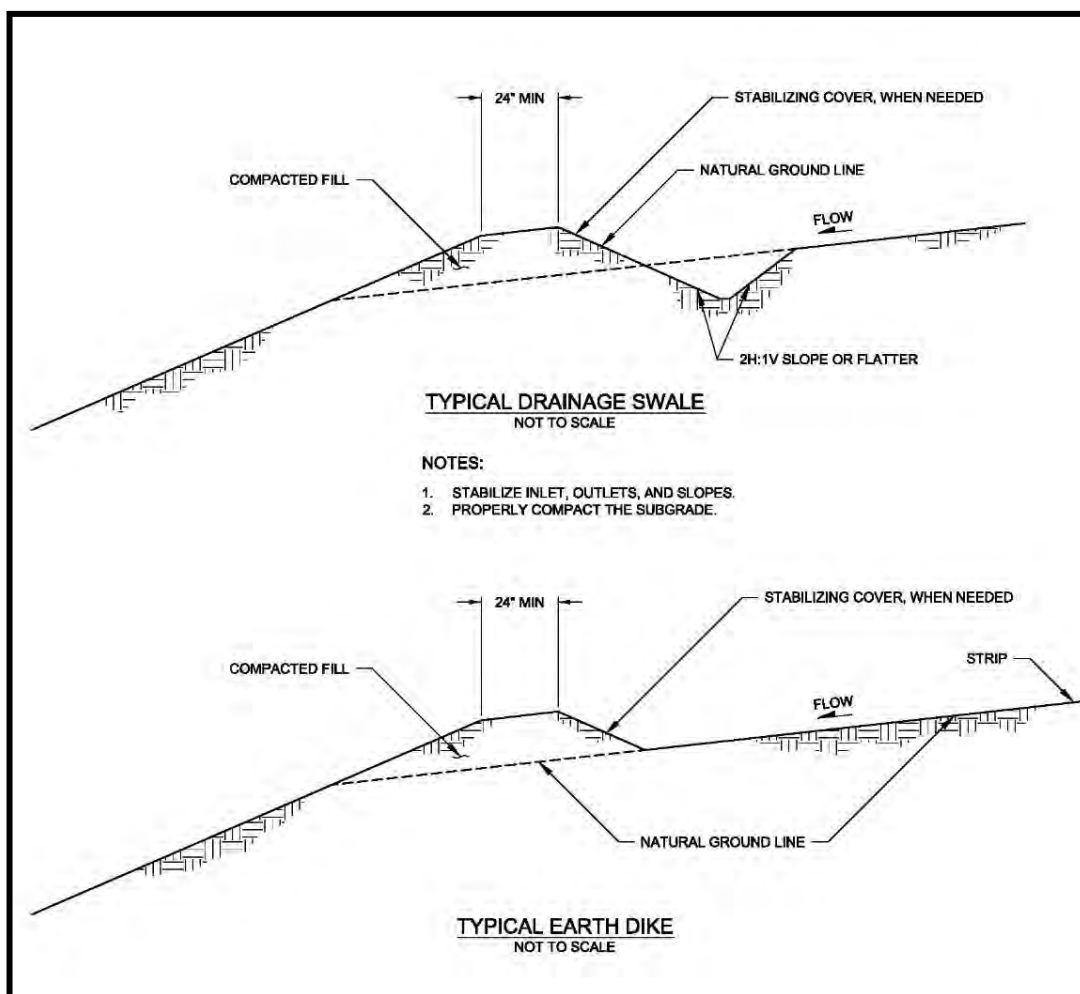

Figure 12. Earth Dike and Drainage Swale.

Planning Considerations

A temporary diversion dike or swale is intended to divert overland sheet flow to a stabilized outlet or a sediment trapping facility during establishment of permanent stabilization on a sloping disturbed area. When used at the top of a slope, the structure protects exposed slopes by keeping upland runoff away. When used at the base of a slope, the structure protects adjacent and downstream areas by diverting sediment-laden runoff to a sediment trapping facility.

If the dike or swale is going to remain in place for longer than 15 days, it must be stabilized with temporary or permanent vegetation. The slope behind the dike or swale is also an important consideration. The dike or swale must have a positive grade to assure drainage, but if the slope is too great, precautions including channel protection and check dams must be taken to prevent erosion due to high velocity of flow.

This practice is considered an economical one because it uses material available on the site and can usually be constructed with equipment needed for site grading. Stabilizing the dike or swale with vegetation can extend the useful life of the BMP.

Design Criteria

- Temporary measures that may also remain as permanent erosion control are typically implemented during construction activities. Review construction for areas where overtopping may occur.
- Subbasin tributary area should be one acre or less.
- Earth dikes must meet the criteria in Table 5.
- Drainage swales must meet the criteria in Table 6.
- An 8- or 12-inch-diameter compost sock may also be used.
- Design the dike and/or swale to contain flows calculated by one of the following methods:
 - Single Event Hydrograph Method: The peak volumetric flow rate from a 10-year, 24-hour frequency storm with a 10-minute time step.
 - Continuous Simulation Method: The 10-year peak flow rate, as determined by an approved continuous runoff model with a 15-minute time step or less.

Maintenance

Inspect the measure after every major storm and make repairs as necessary. Repair damage caused by construction traffic or other activity before the end of each working day.

Table 5. Design Criteria for Earth Dike.

Feature	Requirement
Top Width	2-foot minimum
Height	18-inch minimum measured from upslope toe and at a compaction of 90 percent ASTM D698 standard proctor
Side Slopes	25 percent or flatter
Grade	Topography dependent, except that the dike should be limited to grades between 0.5 and 1.0 percent
Horizontal Spacing of Earth Dikes	<ul style="list-style-type: none"> • Slopes less than 5 percent = 300 feet • Slopes 5–10 percent = 200 feet • Slopes 10–40 percent = 100 feet
Stabilization	<ul style="list-style-type: none"> • Slopes = less than 5 percent. Seed and mulched construction (refer to BMPs E1.10 and E1.15) • Slopes = 5 to 40 percent. Dependent on runoff velocities and dike materials • Stabilization should be done immediately using either sod or riprap to avoid erosion
Outlet	The upslope side of the dike should provide positive drainage to the dike outlet. No erosion should occur at the outlet. Provide energy dissipation measures as necessary. Sediment-laden runoff must be released through a sediment trapping facility.
Other	Minimize construction traffic over temporary dikes

Table 6. Design Criteria for Drainage Swale.

Feature	Requirement
Bottom Width	2-foot minimum. Bottom should be level.
Depth	1-foot minimum
Side Slopes	25 percent or flatter
Grade	5 percent maximum with positive drainage to suitable outlet such as a sediment trap
Stabilization	Seed as per BMP E1.10 temporary seeding or Ecology BMP C130. Riprap 12 inches thick pressed into bank and extending at least 8 inches vertical from the bottom.
Stabilization	Slope of disturbed area: Less than 5 percent = 300 feet 5–10 percent = 200 feet 10–40 percent = 100 feet
Outlet	Level spreader or riprap to stabilized outlet/sedimentation pond

4.3. Sediment Control Practices

Sediment retention practices for construction activities are temporary controls only. Permanent sediment retention requires a separate process for flow control and treatment facilities as outlined in *Volume 3 – Project Stormwater Control*.

Temporary sediment retention BMPs are described in the sections below and include:

- BMP E3.10: Filter Fence (*Section 4.3.1*)
- BMP E3.20: Gravel Filter Berm (*Section 4.3.2*)
- BMP E3.25: ~~Storm Drain~~-Inlet Protection (*Section 4.3.3*)
- BMP E3.30: Vegetated Strip (*Section 4.3.4*)
- BMP E3.35: Straw Wattles, Compost Socks, and Compost Berms (*Section 4.3.5*)
- BMP E3.40: Sediment Trap (*Section 4.3.6*)
- BMP E3.50: Portable Sediment Tank (*Section 4.3.7*)
- BMP E3.60: Construction Stormwater Filtration (*Section 4.3.8*)
- BMP E3.65: Cleaning Inlets and Catch Basins (*Section 4.3.9*)
- BMP E3.70: Street Sweeping and Vacuuming (*Section 4.3.10*)
- Brush Barrier – refer to Ecology BMP C231
- ~~Temporary~~ Sediment Pond (~~Temporary~~~~er~~ basin) – refer to Ecology BMP C241
- Construction Stormwater Chemical Treatment – refer to Ecology BMP C250

The requirements for maintaining these BMPs are included with each description. All temporary sediment retention practices should be maintained and repaired as needed to ensure continued performance of their intended function.

Temporary BMPs must be removed within 5 business days after final site stabilization is achieved, or after they are no longer needed, whichever is later. In either case, trapped sediment must be removed or stabilized on site and the disturbed areas permanently stabilized.

4.3.1. *BMP E3.10: Filter Fence*

Description

A temporary sediment barrier consisting of a filter fabric stretched across and attached to supporting posts and entrenched. The filter fence is constructed of stakes and synthetic filter fabric with a rigid wire fence backing where necessary for support.

Purpose

Filter fence is used during construction operations to intercept and detain small amounts of sediment under sheet flow conditions from disturbed areas in order to prevent sediment from leaving the site, and to decrease the velocity of sheet flows (Figure 13).



Figure 13. Filter Fence Installed on a Slope.

Conditions Where Practice Applies

Filter fence may be used downslope of all disturbed areas and must be provided just upstream of the point(s) of runoff discharge from a site, before the flow becomes concentrated. They may also be used below disturbed areas where runoff may occur in the form of sheet and rill erosion, wherever runoff has the potential to impact downstream resources.

Planning Considerations

Laboratory work at the Virginia Highway and Transportation Research Council has shown that filter fence can trap a much higher percentage of suspended sediments than can straw bales, which have been disallowed by Ecology. The fence must be properly installed to fully function. The installation methods outlined here can improve performance.

Design Criteria

Refer to Figure 14 for design details.

- The drainage area must be 1 acre or less. On larger sites, the fence must be used in combination with sediment basin(s).
- Maximum slope steepness on the site (perpendicular to fence line) is 45 percent.
- Maximum sheet or overland flowpath length to the fence is 100 feet.
- Concentrated flows must not be greater than 0.5 cubic feet per second (cfs).
- Selection of a filter fabric is based on soil conditions at the project site. Soil conditions affect the apparent opening size (AOS) fabric specification. Soils also affect the characteristics of the support fence, which depend on the choice of tensile strength. The designer should specify a filter fabric that retains the soil found on the project site, yet will have openings large enough to permit drainage and prevent clogging. Refer to Table 7 for selection of the AOS.
- The material used in a filter fabric fence must have sufficient strength to withstand various stress conditions. The ability to pass flow through must be balanced with the material's ability to trap sediments.
- Support non-woven and regular strength slit film fabrics with wire mesh, chicken wire, 2-inch x 2-inch wire, safety fence, or jute mesh to increase the strength of the fabric. [FilterSilt](#) fence materials are available that have synthetic mesh backing attached.
- Filter fabric material must contain ultraviolet ray inhibitors and stabilizers to provide a minimum of 6 months of expected usable construction life at a temperature range of 0°F to 120°F.
- One hundred percent biodegradable [filtersilt](#) fence is available that is strong, long lasting, and can be left in place after the project is completed.
- The following design criteria must be used with a Large Project Construction Stormwater ~~and Erosion~~ Control [and Soil Management](#) Plan (*Section 2.1.2*):
 - Purchase filter fabric in a continuous roll cut to the length of the barrier to avoid use of joints. When joints are necessary, splice filter cloth together only at a support post, with a minimum 6-inch overlap. Securely fasten both ends to the post.
 - Space posts a maximum of 6 feet apart and drive securely into the ground a minimum of 30 inches (where physically possible).
 - Excavate a trench approximately 8 inches wide and 12 inches deep along the line of posts and upslope from the barrier. Construct the trench to follow the contour.

- When slit film filter fabric is used, fasten a wire mesh support fence securely to the upslope side of the posts using heavy-duty wire staples at least 1 inch long, tie wires, or hog rings. Extend the wire into the trench a minimum of 4 inches and not more than 36 inches above the original ground surface.
- Wire slit film filter fabric to the fence. Extend 20 inches of the fabric into the trench. Extend the fabric not more than 36 inches above the original ground surface. Filter fabric should not be stapled to existing trees. Other types of fabric may be stapled to the fence.
- When extra-strength or monofilament fabric and closer post spacing are used, the wire mesh support fence may be eliminated. In such a case, staple or wire the filter fabric directly to the posts. Use extra care when joining or overlapping these stiffer fabrics.
- Use properly compacted native material. This is the preferred alternative because the soil forms a more continuous contact with the trench below, and use of native materials cuts down on the number of trips that must be made on and off site.
- Remove filter fabric fences when they have served their useful purpose, but not before the upslope area has been permanently stabilized. Remove retained sediment and properly dispose of, or mulch and seed.

Table 7. Geotextile Standards.

Geotextile Property	Test Method	Geotextile Property Requirements
Polymeric Mesh AOS	ASTM D4751	0.60 mm max. for slit film woven (#30 sieve) 0.30 mm max. for all other geotextile types (#50 sieve) 0.15 mm min. for all fabric types (#100 sieve)
Water Permittivity	ASTM D4491	0.02 sec ⁻¹ min.
Grab Tensile Strength	ASTM D4632	180 lbs. min. for extra strength fabric 100 lbs min. for standard strength fabric
Grab Tensile Strength	ASTM D4632	30% max.
Ultraviolet Resistance	ASTM D4355	70% min.

Maintenance

- Inspect immediately after each rainfall, and at least daily during prolonged rainfall. Repair as necessary.
- Remove sediment when it reaches approximately one-third the height of the fence.
- Spread any sediment deposits remaining in place after the filter fence is no longer required to conform to the existing grade, prepare and seed.
- Repair any damage immediately.
- Intercept and convey all evident concentrated flows uphill of the [filtersilt](#) fence to a sediment pond.
- Check the uphill side of the fence for signs of the fence clogging and acting as a barrier to flow, and causing channelization of flows parallel to the fence. If this occurs, replace the fence or remove the trapped sediment.
- Replace filter fabric that has deteriorated due to ultraviolet breakdown.

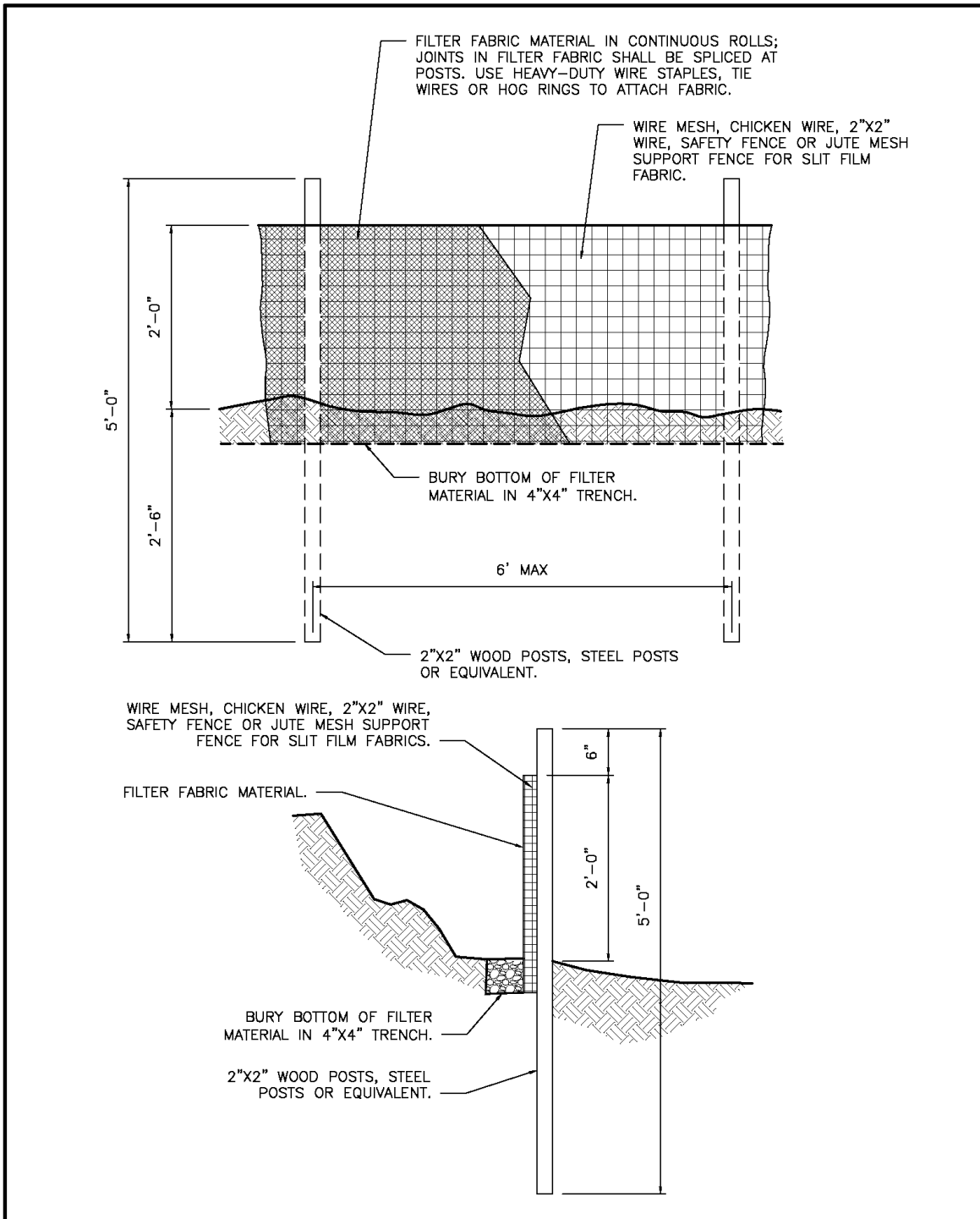

Figure 14. Silt-Filter Fence Details.

4.3.2. BMP E3.20: Gravel Filter Berm

Description

A raised gravel berm or mound constructed in traffic areas.

Purpose

To keep sediment away from traffic areas by filtering runoff through gravel or crushed rock.

Conditions Where Practice Applies

- On private property only. This BMP is not allowed in the public right-of-way.
- Where a temporary measure is needed to retain sediment from traffic areas within the project site.

Design Criteria

- Berm material must be 3/4 to 3 inches in size; washed, well-graded gravel or crushed rock with less than 5 percent fines.
- Spacing of berms, perpendicular to the flow of traffic:
 - Every 300 feet on slopes less than 5 percent
 - Every 200 feet on slopes between 5 and 10 percent
 - Every 100 feet on slopes greater than 10 percent
- Berm dimensions:
 - 1 foot high with 18 percent side slopes
 - 8 linear feet per 1 cfs runoff based on the 10-year, 24-hour design storm

Maintenance

- Inspect regularly. Remove sediment and replace filter material when it becomes clogged.

4.3.3. *BMP E3.25: Storm Drain Inlet Protection*

Description

A sediment filter or an excavated impounding area around a storm drain or catch basin.

Purpose

To prevent sediment from entering storm drainage systems prior to permanent stabilization of the disturbed area.

Conditions Where Practice Applies

Where downslope ~~storm drain~~ inlets are operational prior to permanent stabilization of the disturbed drainage area. Within the project site, protection should be provided for all ~~storm drain~~ inlets downslope and within 500 feet to a block of a disturbed or construction area, whichever is further, unless the runoff that enters the catch basin will be conveyed to a sediment pond or trap.

Drainage areas should be limited to 1 acre or less per inlet. Emergency overflows may be required where stormwater ponding would cause a hazard. If an emergency overflow is provided, additional end-of-pipe treatment may be required. Different types of structures are applicable to different conditions:

- Structures less than 12 inches deep – use other methods to protect the inlet (BMP E3.70 Street Sweeping and Vacuuming).
- Storm drain or catch basin filter sock – applicable on private properties or within the public right-of-way for structures greater than 12 inches deep.
- Block and gravel curb inlet protection – applicable for private properties only, on a paved surface. Sturdy, but limited filtration. Consists of a barrier formed around an inlet with concrete blocks and gravel (Figure 15).
- Curb and gutter barrier – applicable for private properties only, using a sandbag or rock berm (riprap and aggregate) 3 feet high and 3 feet wide in a horseshoe shape (Figure 16). An 8- or 12-inch diameter compost sock may also be used in temporary, low-velocity applications.

Planning Considerations

- The best way to prevent sediment from entering the storm drain is to stabilize the site as quickly as possible, preventing erosion and stopping sediment at its source. Proper implementation of other BMPs, such as filter fence (BMP E3.10), straw wattles (BMP E3.35) and covering practices can eliminate or reduce the need for downstream inlet protection, and their implementation is mandatory. Clean out the stormwater drain or catch basin prior to implementing this BMP (refer to BMP E3.65 Cleaning Inlets and Catch Basins).
- Within the project site, remove BMP within 5 business days after final site stabilization is achieved or after it is no longer needed, whichever is longer. Daily removal is required when the BMP is necessary and approved to be installed in the street inlets/catch basins for short durations to protect the public drainage system or public combined sewer from pollution generating activities, such as ~~sawcuttingsaw-cutting~~, utility excavation or paving.

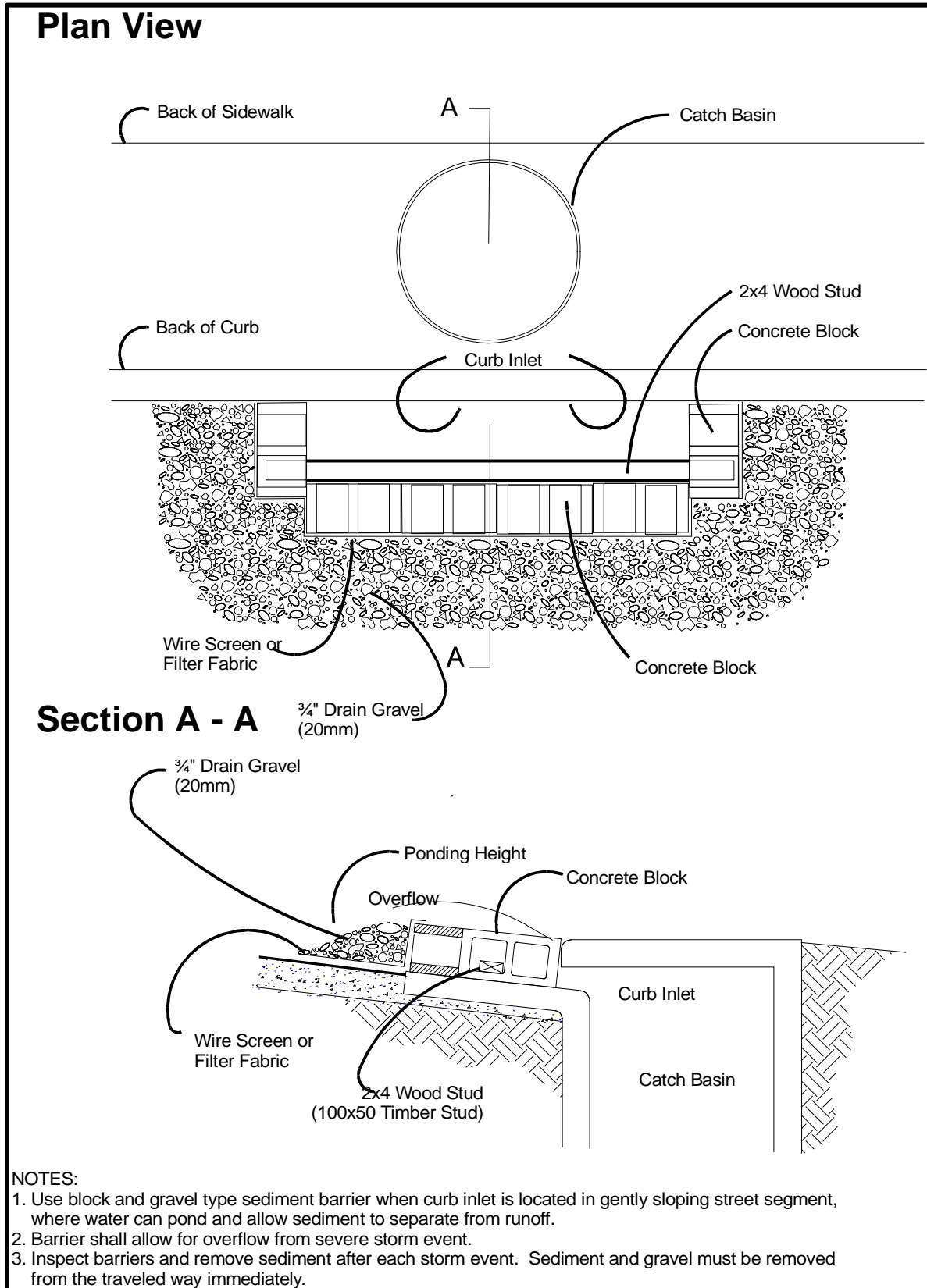

Figure 15. Block and Gravel Curb Inlet Protection.



Figure 16. Curb and Gutter Barrier.

- All methods for [storm drain](#)-inlet protection are prone to plugging and require a high frequency of maintenance.
- Storm drains made operational before their drainage area is stabilized can convey large amounts of sediment to natural drainage channels. In cases of extreme sediment loading, the storm drain itself may clog and lose a major portion of its capacity. To avoid these problems, it is necessary to prevent sediment from entering the system at the inlets.
- Several types of inlet filters and traps have different applications that depend on site conditions and type of inlet. Other innovative techniques for accomplishing the same purpose are encouraged, but only after specific plans and details are submitted to and approved by the SDCI. Note that these various inlet protection devices are for drainage areas of less than 1 acre. Runoff from larger disturbed areas should be routed through a [Temporary Sediment Pond or Trap-or-Pond](#) (refer to Ecology BMPs C241 and E3.40).

Design Criteria

- Secure grates and spaces of all inlets to prevent seepage of sediment-laden water.
- All catch basin protection measures should include sediment sumps of 1 to 2 feet in depth with 25 percent side slopes.
- Installation procedure for a drain or catch basin filter sock:
 - For structures greater than 12 inches deep, the filter sock can be laid into the inlet as long as the overflow opening is in the direction of the outlet pipe.
 - Trim and remove filter sock material that extends beyond the grate.
 - Make provisions to decant accumulated sediment.
 - Install a high-flow bypass that will not clog under normal use at a project site.
- Installation procedures for block and gravel curb inlet protection:
 - Place two concrete blocks on their sides abutting the curb at either side of the inlet opening—these are spacer blocks.
 - Place a piece of lumber through the outer holes of each spacer block to align the front blocks.
 - Place blocks on their sides across the front of the inlet and abutting the spacer blocks.
 - Place wire mesh with 1/2-inch openings over the outside vertical face.
 - Pile coarse aggregate against the wire to the top of the barrier.
- Installation procedures for curb and gutter sediment barrier:
 - Construct a horseshoe shaped berm.
 - If using riprap, create a face with coarse aggregate 3 feet high and 3 feet wide, at least 2 feet from the inlet.

Maintenance

- Inspections should be made on a regular basis, especially after large storm events. Inlet protection devices should be cleaned or removed and replaced when sediment has filled one-third of the available storage (unless a different standard is specified by the product manufacturer).
- Do not wash sediment into storm drains while cleaning. Spread all excavated material evenly over the surrounding land area or stockpile and stabilize as appropriate.

4.3.4. *BMP E3.30: Vegetated Strip*

Description

A vegetated area located downslope of a disturbed area that is capable of filtering coarse sediment from runoff and slowing runoff velocities.

Purpose

Vegetated strips reduce the transport of coarse sediment from a project site by providing a temporary physical barrier to sediment and reducing the runoff velocities of overland flow.

Conditions Where Practice Applies

- Vegetated strips may be used downslope of all disturbed areas, placed parallel to the toe of the slope.
- Vegetated strips are not intended to treat concentrated flows, nor are they intended to treat substantial amounts of overland flow. Any concentrated flows must be conveyed through the drainage system to a sediment pond. The only circumstance where overland flow can be treated solely by a strip, rather than by a sediment pond, is when the strip flowpath length can be achieved with the associated average slope (Table 8).

Table 8. Vegetated Strip Implementation Criteria.

Average Slope	Slope Percent	Flowpath Length
1.5H:1V or less	67% or less	100 feet
2H:1V or less	50% or less	115 feet
4H:1V or less	25% or less	150 feet
6H:1V or less	16.7% or less	200 feet
10H:1V or less	10% or less	250 feet

Design Criteria

- The vegetated strip must consist of a minimum of a 25-foot wide continuous strip of dense vegetation with permeable topsoil. Grass covered, landscaped areas are generally not adequate because the volume of sediment overwhelms the grass. Ideally, vegetated strips should consist of undisturbed native growth with a well-developed soil that allows for infiltration of runoff.
- The slope within the strip must not exceed 25 percent.
- Delineate the uphill boundary of the vegetated strip with clearing limits.

Maintenance

- Immediately seed and mulch any areas damaged by erosion or construction activity.
- Install sod if more than 5 feet of the original vegetated strip width has had vegetation removed or is being eroded.
- If there are indications that concentrated flows are traveling across the buffer, install stormwater controls to reduce the flows entering the buffer, or install additional perimeter protection.

4.3.5. *BMP E3.35: Straw Wattles, Compost Socks, and Compost Berms*

Description

Temporary erosion and sediment control barriers consisting of encased straw, encased compost, or a compost berm.

Straw wattles consist of straw that is wrapped in biodegradable tubular plastic or similar encasing material. Straw wattles are typically 8 to 10 inches in diameter and 25 to 30 feet in length. The wattles are placed in shallow trenches and staked along the contour of disturbed or newly constructed slopes (Figure 17). Compost socks consist of a net tube, similar to straw wattles, filled with compost, and available in biodegradable mesh, or non-biodegradable mesh for installations longer than 6 months. Compost berms are ~~triangular cross-section~~ rows of compost with a triangular cross-section that can serve a similar function as wattles or socks. Compost socks and berms typically do not require trenching.



Figure 17. Straw Wattles or Compost Sock for Inlet Protection.

Purpose

To reduce the velocity, spread the flow of rill and sheet runoff, and capture and retain sediment.

Conditions Where Practice Applies

- Disturbed areas that require immediate erosion protection.
- Exposed soils during short construction delays, or over winter months.
- On slopes requiring stabilization until permanent vegetation can be established.
- For inlet protection or elsewhere on top of pavement to filter or direct flow.
- As an alternative to [filters](#) fence for perimeter control.

Planning Considerations

- Compost socks and straw wattles are effective for 1 to 2 seasons. Berms are effective for 1 to 2 weeks, or longer if vegetated and/or protected by fencing.
- If conditions are appropriate, straw wattles and compost socks can be staked to the ground using willow cuttings for added re-vegetation. Compost socks can also be filled with a compost/seed mix to provide temporary or permanent vegetation. Use biodegradable socks for permanent installations.

Design Criteria

- It is critical that straw wattles and compost socks are installed perpendicular to the flow direction and parallel to the slope contour (Figure 18). Rilling can occur beneath straw wattles if not properly entrenched and water can pass between straw wattles and compost socks if not tightly abutted together.
- In most conditions, compost socks do not require trenching (because of their superior ground contact). Straw wattles do require trenching.
- For straw wattles, dig narrow trenches across the slope on contour to a depth of 3 to 5 inches on clay soils and soils with gradual slopes. Construct trenches at contour intervals of 3 to 30 feet apart depending on the steepness of the slope, soil type, and rainfall. The steeper the slope the closer together the trenches.
- Start building trenches and installing wattles from the base of the slope and work up. Spread excavated material evenly along the uphill slope and compact using hand tamping or other methods.
- Install straw wattles snugly into the trenches and abut tightly end to end. Do not overlap the ends. Install stakes at each end of the wattle, and at 4-foot centers along entire length of wattle. If required, install pilot holes for the stakes using a straight bar to drive holes through the wattle and into the soil.
- On loose soils, steep slopes, and areas with high rainfall, dig the trenches to a depth of 5 to 7 inches, or 1/2 to 2/3 of the thickness of the wattle.
- At a minimum, use wooden stakes that are approximately 3/4 inches square and 24 inches long. Willow cuttings or 3/8-inch rebar can also be used for stakes. Drive stakes through the middle of the straw wattle or compost sock, leaving 2 to 3 inches of the stake protruding above the wattle or sock.
- Compost socks are usually placed on the prepared surface, without trenching, so long as no rilling exists on that surface. If the surface is sloped, stake through the sock at 10-foot intervals, or more closely on steeper slopes. After staking, walk down the top of the sock to press it onto the ground surface.

- Compost berms are typically 1 foot high by 2 feet wide at the base, or 18 inches high and 3 feet wide.
- Protect compost berms from foot or vehicle traffic by a fence, or otherwise immediately seed to provide stability. Short-term (one to two week) applications may not require protection and stabilization.

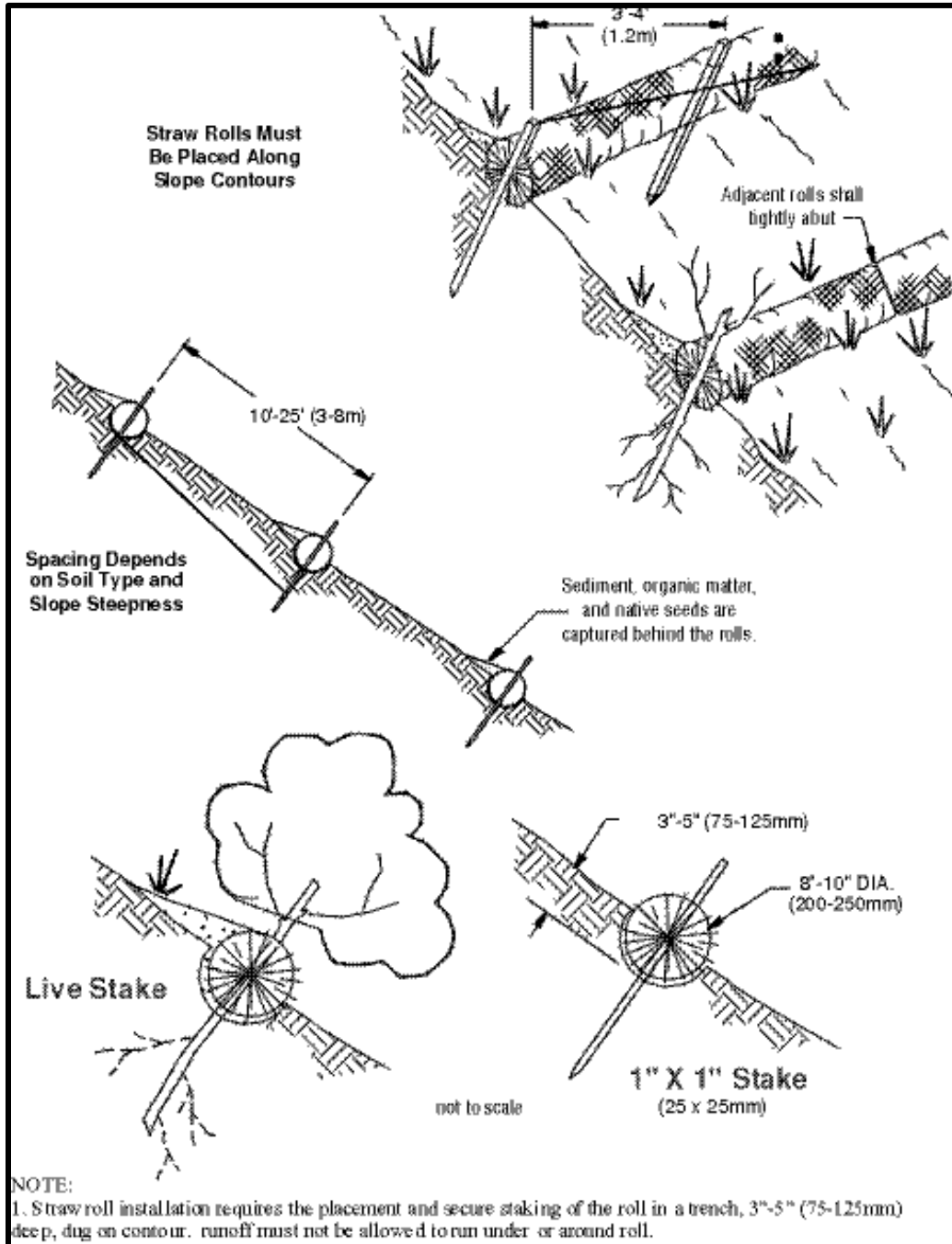

Figure 18. Straw Wattle Details.

Maintenance

- Inspect wattles to ensure they are in contact with soil and thoroughly entrenched, especially after significant rainfall on steep sandy soils. Repair as necessary.
- Straw wattles and compost socks can be compressed by vehicle traffic, creating an overflow point. Repair immediately.
- Inspect the slope after significant storms and repair any areas where wattles are not tightly abutted or water has scoured beneath the wattles.

4.3.6. *BMP E3.40: Sediment Trap*

Sizing is perhaps less important than constant maintenance for this BMP because it is a temporary control. Inspections must be made and sediment removed regularly for sediment traps to function well.

Description

A small temporary ponding area with a gravel outlet formed by excavation and/or by constructing an earthen embankment.

Purpose

To collect and store sediment from project sites cleared and/or graded during construction. It is intended for use in relatively small drainage basins, with no unusual drainage features, and a projected quick build-out time. It should help in reducing silt-laden runoff which clogs offsite conveyance systems and destroys habitat, particularly in streams.

Conditions Where Practice Applies

Proposed building sites where the tributary drainage basin is less than 3 acres.

Planning Considerations

- Prior to leaving a project site where the tributary drainage is 3 acres or less, stormwater runoff must pass through a sediment pond or other appropriate sediment removal BMP (refer to Table 1a and Table 1b for other approved stormwater controls).
- If the contributing drainage area is greater than 3 acres, refer to Ecology BMP C241 Sediment Ponds [\(Temporary\)](#), or subdivide the tributary drainage area.
- The trap is a temporary measure (with a design life of approximately 6 months) and is to be maintained until the project site is permanently protected against erosion by vegetation and/or structures.
- Sediment must be periodically removed from the trap. Plans should detail how this sediment is to be disposed of, such as by use in fill areas on site or removed to an approved offsite dump. Sediment traps, along with other perimeter controls, must be installed before any land disturbance takes place in the drainage area.
- Alternative Methods: Consider using a temporary aboveground storage tank (e.g., Baker Tank) for temporary storage. If a tank cannot be used, consider using a pond with pumping capabilities to another temporary holding structure. Refer to BMP E3.50 Portable Sediment Tank.
- Wherever possible, sediment-laden water should be discharged into onsite, relatively level, vegetated areas (refer to BMP E3.30 Vegetated Strip).
- Projects that are constructing permanent flow control BMPs or runoff treatment BMP control facilities are part of the project that use ponding for treatment, may use the rough-graded or final-graded permanent BMP footprint for the temporary sediment trap, they should be used for sediment retention. Refer to *Volume 3 – Project Stormwater Control* for additional requirements.

Safety

Sediment traps and ponds should be limited to project sites where failure of the structure would not result in loss of life, damage to homes or buildings, or interruption of use or service of public roads or utilities.

Sediment traps and ponds are attractive to children and can be very dangerous. Local ordinances regarding health and safety must be adhered to. If fencing of the pond is required, the type of fence and its location must be shown in the Construction Stormwater Pollution Control Plan.

Design Criteria

~~If permanent runoff control facilities are part of the project, they should be used for sediment retention. Refer to Volume 3 - Project Stormwater Control for additional requirements.~~

To determine the sediment trap geometry, first calculate the design surface area (SA) of the trap, measured at the invert of the weir (Figure 19). Use the following equation:

$$SA = FS(Q_2/V_s)$$

Where:

Q_2 = [Peak volumetric flow rate](#)

The [peak volumetric design flows rate shall](#) may be [calculated by one of the following methods determined using either single event or continuous simulation hydrologic modeling](#);

- [Single Event Hydrograph Method: Design inflow based on T](#)the peak [volumetric flow rate](#) discharge from [at the developed 2-year, 24-hour design storm with a 10-minute time step runoff event from the contributing drainage area as computed in the hydrologic analysis](#). The 10-year peak [volumetric flow rate shall](#) should be used if the project size, expected timing and duration of construction, or downstream conditions warrant a higher level of protection.
- [If C](#)continuous [S](#)simulation [M](#)methods [are used](#); [use t](#)The 50 percent annual probability or 10 percent annual probability flows (2-year or 10-year recurrence interval, respectively) as outlined above [with, and modeled using](#) a 15-minute time step or less.
- [Rational Method:](#) If no hydrologic analysis is required for the other portions of the site design (conveyance, flow control, and/or water quality control) [and the site is less than 1 acre](#), the Rational Method may be used for sediment trap design. Refer to [Appendix F](#) for additional guidelines.

V_s = the settling velocity of the soil particle of interest. The 0.02 millimeter (mm) (medium silt) particle with an assumed density of 2.65 grams per cubic centimeter (g/cm^3) has been selected as the particle of interest and has a settling velocity (V_s) of 0.00096 ft/sec.

FS = A safety factor of 2 to account for non-ideal settling.

Therefore, the equation for computing [sediment trap](#) surface area becomes:

$$SA = \frac{2 \times Q_2}{0.00096} \quad \text{or} \quad 2,080 \text{ square feet per cfs of inflow}$$

Note: Even if permanent facilities are used, they must still have a surface area that is at least as large as that derived from the above formula. If they do not, the pond must be enlarged.

The outlet riser or pipe should be [4.53.5](#) feet minimum above bottom to draw clean water and avoid discharging sediment that is still suspended in the lower part of the water column.

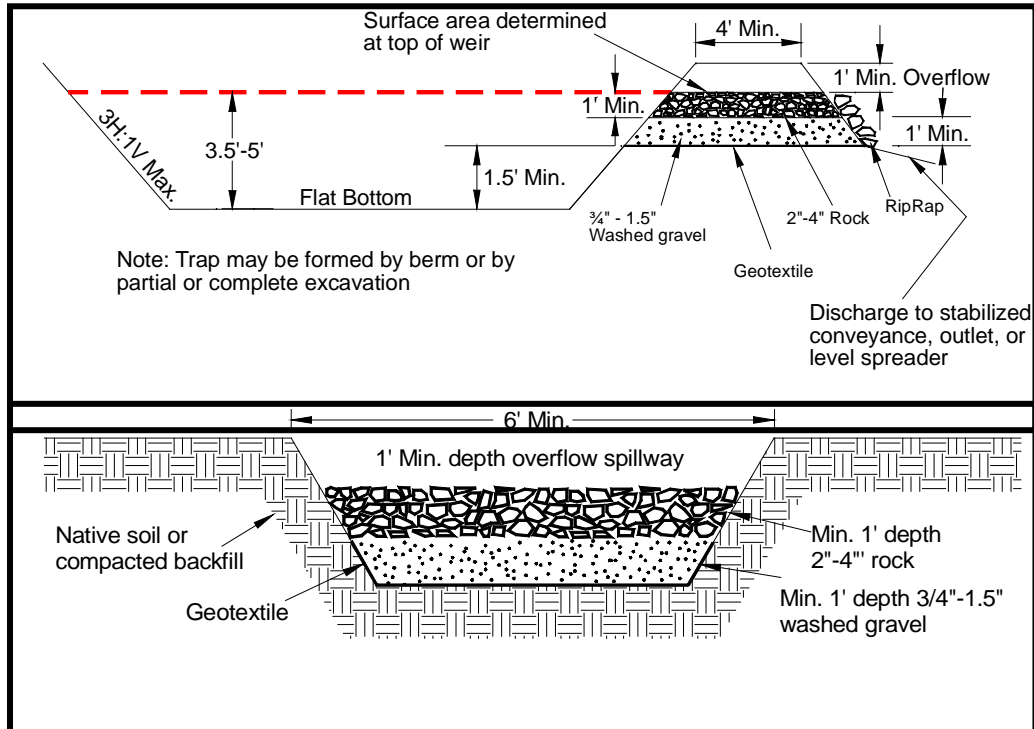

Figure 19. Cross Section of Sediment Trap and Outlet.

To aid in determining sediment depth, all sediment traps should have a staff gauge with a prominent mark 1 foot above the bottom of the trap.

Maintenance

- The sediment trap must be continually monitored and regularly maintained. The size of the trap is less important to its effectiveness than is regular sediment removal. Remove sediment from the trap when it reaches approximately 1 foot in depth (assuming a 1-1/2 foot sediment accumulation depth). Conduct regular inspections and additional inspections after each large runoff-producing storm.
- Maintain and repair all temporary and permanent erosion and sediment control practices as needed to assure continued performance of their intended function.
- Remove all temporary erosion and sediment control measures within 5 business days after final site stabilization is achieved, or after the temporary BMPs are no longer needed, whichever is longer. Remove trapped sediment or stabilize on site. Permanently stabilize disturbed soil areas resulting from removal.

4.3.7. *BMP E3.50: Portable Sediment Tank*

Description

A compartmental tank brought temporarily to a project site. Sediment-laden water is pumped into the tank to trap and retain sediment.

Purpose

A portable sediment tank is used for temporary storage of sediment-laden water and to trap and retain sediment prior to discharging to an appropriate discharge point.

Conditions Where Practice Applies

A portable sediment tank should be used on sites where excavations are deep and space is limited, or wherever the tank can be located per the manufacturer's specifications with an appropriate discharge point.

Planning Considerations

Using a portable sediment tank is the preferred method to minimize potential impacts to the project site. The tank configuration, size, location, and discharge point must be presented in the Construction Stormwater ~~and Erosion~~ Control and Soil Management Plan and approved by the City.

Follow the manufacturer's or vendor's specifications for choosing the appropriate location. In addition, the tank should be located for ease of clean-out and disposal of trapped sediment, and to minimize the interference with construction activities and pedestrian traffic.

If a permit is obtained for discharge to a combined sewer system conduct all discharge activities in accordance with permit requirements, including when it can be discharged, and the discharge flow rate.

Design Criteria

Sediment tanks must have a minimum depth of 2 feet and be designed to allow for emergency flow to an approved discharge point. Outlet riser or pipe should be 1.5 feet minimum above bottom to draw clean water and avoid discharging sediment that is still suspended in the lower part of the water column.

As noted above, tank configuration and size must be presented in the Construction Stormwater ~~and Erosion~~ Control and Soil Management Plan and approved by the City. For planning purposes, the following formula should be used in determining the minimum storage volume of the sediment tank. Additional storage volume may be required by the City.

Pump Discharge Design inflow in gallons per minute (gpm) x 16 = cubic feet storage.
See Refer to Section 4.3.6 for BMP E3.40 Sediment Traps for design inflow selection requirements.

Container designs can vary from cylindrical tanks to rectangular boxes, depending on the manufacturer. Any tank configuration can be used if the storage volume is adequate and approval is obtained from the City.

Effectiveness

The pollution removal efficiency of the sediment tank can be increased by using flocculation chemicals, such as alum (aluminum sulfate) in the tank. Flocculation will allow very small suspended particles to settle out and decrease the time it takes for larger particles to settle out. Flocculation tank setup is considerably more complicated as the rate of flocculent addition must be carefully monitored.

For sites that do not require coverage under Ecology's Construction Stormwater General Permit, formal written approval from the City is required to use chemical treatment such as flocculation chemicals, regardless of site size. Any proposed chemicals and the method of use must also be formally approved by Ecology. Refer to Ecology BMP C250 [and Appendix B](#) for more information on chemical treatment.

Alternatives

An alternative to a portable sediment tank is a tank constructed using steel drums, sturdy wood, or other material suitable for handling the pressure exerted by the volume of the water.

- Sediment tanks must have a minimum depth of 2 feet.
- The tank must be located for easy clean-out and disposal of the trapped sediment and to minimize the interference with construction activities.
- Once the water level nears the top of the tank, the pump must be shut off while the tank drains and additional capacity is made available.
- Clean out the tank as soon as one-third of the original capacity is depleted due to sediment accumulation. The tank must be clearly marked showing the cleanout point.
- An appropriate discharge point must be selected, and approved by the City.

Maintenance

- Follow the manufacturer's or vendor's specifications.
- During construction, inspect BMPs daily during the work week with additional inspections scheduled during storm events. Make any required repairs immediately.
- Inspect filtering or control devices frequently. Repair or replace them to ensure that the structure functions as designed.
- Clean out the tank as soon as one-third of the original capacity is depleted due to sediment accumulation. The tank must be clearly marked showing the clean-out point. Removed sediment may be disposed of on site if no contamination is present. Contaminated sediment must be disposed of according to local governing agency requirements.
- Systems should be filled in or otherwise removed when permanent dewatering controls are in place and connected to an approved treatment and receiving system.

4.3.8. *BMP E3.60: Construction Stormwater Filtration*

Description

Use of a filter to remove sediment from stormwater runoff.

Purpose

Filtration removes sediment from runoff originating from disturbed areas of the site.

Conditions Where Practice Applies

Construction stormwater filtration should be used when traditional [construction stormwater BMPs](#) used to control soil erosion and sediment loss from [construction project](#) sites may not be adequate to ensure compliance with the water quality standard for turbidity in the receiving water. Filtration may be used in conjunction with gravity settling to remove sediment as small as fine silt (0.5 micrometers [μm]). The reduction in turbidity will be dependent on the particle size distribution of the sediment in the stormwater. In some circumstances, sedimentation and filtration may achieve compliance with the water quality standard for turbidity.

Unlike chemical treatment, the use of construction stormwater filtration does not require approval from Ecology. Filtration may also be used in conjunction with polymer treatment in a portable system to assure capture of the flocculated solids. Filtration in conjunction with polymer treatment requires testing under the Chemical Technology Assessment Protocol – Ecology (CTAPE) before it can be initiated. Approval from [the appropriate regional Ecology office](#) must be obtained at each site where [chemical polymers](#) use is proposed prior to use. For more guidance on stormwater chemical treatment, refer to Ecology BMP C250.

Filtration with sand media has been used for over a century to treat water and wastewater. The use of sand filtration for treatment of stormwater has developed recently, generally to treat runoff from streets, parking lots, and residential areas. The application of filtration to construction stormwater treatment is currently under development.

Design Criteria

Two types of filtration systems may be applied to construction stormwater treatment: rapid and slow.

- Rapid [filtration systems](#)~~sand filters~~ are the typical system used for water and wastewater treatment. They can achieve relatively high hydraulic flow rates, on the order of 2 to 20 gallons per minute per square foot (gpm/sf), because they have automatic backwash systems to remove accumulated solids.
- ~~In contrast, S~~low [filtration systems](#)~~sand filters~~ have very low hydraulic rates, on the order of 0.02 gpm/sf, because they do not have backwash systems. ~~To date, S~~low [sand filtration systems](#) ~~have~~ generally been used [as post-construction BMPs](#) to treat stormwater. Slow [sand filtration](#) is mechanically simple in comparison to rapid ~~sand filtration~~, but requires a much larger filter area.

Filter Type and Efficiencies~~Filtration Equipment~~

Sand media filters are available with automatic backwashing features that can filter to 50 µm particle size. Screen or bag filters can filter down to 5 µm. Fiber wound filters can remove particles down to 0.5 µm. Filters should be sequenced from the largest to the smallest pore opening. Sediment removal efficiency will be related to particle size distribution in the stormwater.

Treatment Process and Description

Stormwater is collected at interception point(s) on the site and is diverted to [an untreated stormwater](#) sediment pond or tank for removal of large sediment and storage of the stormwater before it is treated by the filtration system. ~~In a rapid filtration system, the untreated stormwater is pumped from the trap, pond, or tank through the filtration media system in a rapid sand filtration system.~~ Slow sand filtration systems are designed as ~~flow through systems~~ using gravity ~~to convey water from the pond or tank through the filtration media.~~ If large volumes of concrete are being poured, pH adjustment may be necessary (refer to BMPs [C1.56](#), [C1.58](#), and [C1.59](#)).

Sizing Criteria for Flow-through Treatment Systems for Discharges to Designated Receiving Waters:

~~Filtration treatment systems must be designed to control the velocity and peak volumetric flow rate that is discharged from the system and consequently the project site. Refer to Element 4 Protect Downstream Properties and Receiving Waters (SMC 22.805.020.D) for further detail on this requirement.~~

~~When sizing storage ponds or tanks for flow through systems for water bodies exempt from flow control, the treatment system capacity should be a factor.~~ The untreated stormwater storage pond or tank should be sized to hold 1.5 times the runoff volume of the 10-year, 24-hour storm event minus the treatment system flow rate for an 8-hour period. For a chitosan-enhanced sand filtration system, the treatment system flow rate should be sized using a hydraulic loading rate between 6-8 gpm/sf. Other hydraulic loading rates may be more appropriate for other systems. Bypass should be provided around the ~~filtration~~ ~~chemical~~ treatment system to accommodate extreme storms. Runoff volume should be calculated using the methods presented in *Volume 3, Chapter 4*. Worst-case ~~land cover~~ conditions (i.e., producing the most runoff ~~most likely condition present prior to final landscaping~~) should be used for analyses ~~(in most cases, this would be the land cover conditions just prior to final landscaping)~~.

Sizing Criteria for Listed Creek Basins and Non-listed Creek Basins:

Sites that must implement flow control for developed site conditions must also control stormwater release rates during construction.

Maintenance

- Rapid sand filters typically have automatic backwash systems triggered by a pre-set pressure drop across the filter. If the backwash water volume is not large or substantially more turbid than the stormwater stored in the holding pond or tank, return of backwash to the pond or tank may be appropriate. However, land application or another means of treatment and disposal may be necessary.
- Screen, bag, and fiber filters must be cleaned and/or replaced when they become clogged.
- Sediment should be removed from the storage and/or treatment ponds as necessary. Typically, sediment removal is required once or twice during a wet season and at the decommissioning of the ponds.

4.3.9. BMP E3.65: Cleaning Inlets and Catch Basins

Description

Removal of debris from existing inlets, catch basins, and connecting pipelines to protect and maintain private facilities and the public drainage system.

Purpose

The purpose of cleaning inlets and catch basins is to restore the function of the drainage collection system and reduce sediment transfer through the public drainage system or public combined sewer system.

Conditions Where Practice Applies

- Whenever other sediment control BMPs are not feasible or have failed.
- Whenever the public drainage collection facilities immediately downstream are not functioning.
- Whenever there is ponding in the travel lanes of the public roadway.

Planning Considerations

Large amounts of sediment can be conveyed through inlets, catch basins and the public drainage system or public combined sewer. Sediment can also plug these facilities, causing a flooding hazard or a hazard to traffic and pedestrians in the public roadway. Protection from sediment and debris is not always possible or effective; therefore, cleaning is the last action taken.

The best ways to prevent sediment from entering the storm drain are:

- To control the discharge points
- Stabilize the site to control pollution at its source
- Good housekeeping such as sweeping, vacuuming, and cleaning (BMP E3.70)

It is important to identify which BMP is feasible at each point of drainage collection and discharge, and during each construction phase. Inlet and catch basin cleaning must be performed when other protection methods are not possible or fail.

Design Criteria

- Identify the drainage flowpath(s) on site and downstream for a minimum distance of 500 feet or one block, whichever is further in the public roadway.
- Identify the location of all existing inlets and catch basins within the project area that may be impacted. Identify whether they will remain, be removed, or abandoned during construction.
- When an inlet or catch basin is to be removed or abandoned, plug that path to the public drainage system or public combined sewer prior to demolition of the immediate surroundings.

- ~~Storm drain~~ Inlet protection (BMP E3.25) is required when feasible. When it is not feasible, or fails, clean affected inlets, catch basins, and connecting pipe.
- Use a vacuum truck or shovels with proper disposal for cleaning. Jetting material downstream into the public drainage system or public combined sewer is not allowed.
- Protect new inlets and catch basins from onsite sediment and clean after site stabilization, as necessary.

Maintenance

- Regularly inspect inlets and catch basins on site and within a distance of 500 feet or one block, whichever is further, in the public roadway. Increase inspections as necessary, especially after street sweeping.
- Clean inlets when sediment and/or debris are visible.
- Clean catch basins whenever debris and/or sediment occupy more than one-half the capacity or ~~are~~ within 18 inches of the outlet pipe invert.
- Always clean inlets and catch basins after site stabilization.

4.3.10. BMP E3.70: Street Sweeping and Vacuuming

Description

Use of human-powered and/or mechanical equipment to collect sediment on paved surfaces to minimize sediment accumulation in private systems and the public drainage system. This BMP may also be used to clean paved surfaces in preparation for final paving.

Purpose

Sweeping and vacuuming minimizes project area sediment from entering the public drainage system or public combined sewer. Targeted pollutants include: sediment, nutrients, trash, metals, bacteria, oil and grease, and organics.

Conditions Where Practice Applies

Sweeping and vacuuming are suitable on any paved surface and, in particular, anywhere sediment is tracked from the project site onto public or private paved streets and roads, typically at the stabilized construction [entrance-access](#) (BMP E2.10) and other construction access points. Sweeping and vacuuming are also applicable during preparation of paved surfaces for final paving.

Planning Considerations

Sweeping and vacuuming may not be effective when sediment is wet or when tracked soil is caked (caked soil may need to be scraped loose). Washing is not an alternative to sweeping and vacuuming because of the risk of pollutant transport.

Design Criteria

- Control the number of points where vehicles can leave the site to allow focused sweeping and vacuuming efforts.
- Do not use kick brooms or sweeper attachments.
- If not mixed with debris or trash, consider incorporating the removed sediment back into the project.

Maintenance

- After initiating sweeping and/or vacuuming, inspect the potential sediment tracking locations daily to ensure they are clean of any sediment.
- Visible sediment tracking should be swept or vacuumed on a daily basis.
- Be careful not to sweep up any unknown substance or any object that may be potentially hazardous.
- Adjust brooms frequently; maximize efficiency of sweeping operations.
- After sweeping is finished, properly dispose of sweeper wastes at an approved disposal site.

CHAPTER 5 – SOURCE CONTROL PRACTICES FOR CONSTRUCTION POLLUTANTS OTHER THAN SEDIMENT

5.1. Source Control Practices

The City of [Seattle \(City\)](#) is committed to protecting the public drainage system or public combined sewer, ponds, wetlands, lakes, streams, and coastal and estuarine water bodies from damage by sediment and other pollutants generated during construction activities. The focus of *Chapter 4* was on erosion and sediment control; however, potential pollutants other than sediment are common at project sites and may also impact stormwater and groundwater quality when they come into direct contact with runoff.

Potential pollutants include non-hazardous materials such as wood, paper, demolition debris, concrete, and metal scraps. There are also potential pollutants from hazardous materials and their associated wastes such as pesticides (e.g., insecticides, fungicides, herbicides, rodenticides), petrochemicals (e.g., oils, gasoline, asphalt degreaser) and other construction chemicals such as concrete products, sealer, paints, and washwater associated with these products.

The most economical and effective controls for pollutants other than sediment are good “housekeeping” practices, and an awareness by construction workers, planners, engineers, and developers of the need for and purpose of compliance with federal, state, and local regulations.

Please refer to the Stormwater Code and *Volume 4 – Source Control* for further information concerning controlling pollution at the source and preventing contamination of stormwater for all discharges. This volume should be reviewed to ensure that all Director’s Rules requirements are being met for each construction project.

The standards for each individual [best management practice \(BMP\)](#) are divided into six sections:

1. Description
2. Purpose
3. Conditions Where Practice Applies
4. Planning Considerations
5. Design Criteria
6. Maintenance

Note that some BMPs were divided into different sections to reflect their individual needs. As with erosion and sediment control BMPs, source control BMPs include “Conditions Where Practice Applies,” which always refers to site conditions. As site conditions change, BMPs must be changed to remain in compliance.

This chapter contains the standards and specifications for source control BMPs to properly manage construction pollutants other than sediment. They include:

- BMP C1.15: Material Delivery, Storage, and Containment (*Section 5.1.1*)
- BMP C1.20: Use of Chemicals During Construction (*Section 5.1.2*)
- BMP C1.25: Demolition of Buildings (*Section 5.1.3*)
- BMP C1.30: Building Repair, Remodeling, and Construction (*Section 5.1.4*)
- BMP C1.35: Sawcutting and Paving Pollution Prevention (*Section 5.1.5*)
- BMP C1.40: Temporary Dewatering (*Section 5.1.6*)
- BMP C1.45: Solid Waste Handling and Disposal (*Section 5.1.7*)
- BMP C1.50: Disposal of Asbestos and Polychlorinated Biphenyls (PCBs) (*Section 5.1.8*)
- BMP C1.55: Airborne Debris Curtain (*Section 5.1.9*)
- BMP C1.56: Concrete Handling and Disposal (*Section 5.1.10*)
- BMP C1.59: High pH Neutralization Using CO₂ (*Section 5.1.11*)

5.1.1. *BMP C1.15: Material Delivery, Storage, and Containment*

Description

Best practices for all deliveries, storage, and containment of materials, liquid and solid on a project site that may potentially pollute stormwater.

Purpose

The purpose of this BMP is to prevent, reduce, or eliminate the discharge of pollutants to the drainage system or receiving water from the delivery and storage of materials on site. This is achieved by minimizing the storage of hazardous materials on site, storing materials in a designated area, and installing secondary containment.

Conditions Where Practice Applies

These procedures are recommended for use at all project sites with delivery and storage of the following materials:

- Petroleum products such as fuel, oil and grease
- Soil stabilizers and binders (e.g., Polyacrylamide)
- Fertilizers, pesticides, and herbicides
- Detergents
- Asphalt and concrete compounds
- Hazardous chemicals such as acids, lime, adhesives, paints, solvents and curing compounds
- Any other material that may be detrimental if released to the environment

Planning Considerations

Dangerous solid wastes must be stored and handled according to special guidelines and may require a permit. Follow the regulations and requirements outlined by [the Washington State Department of Ecology \(Ecology\)](#) and, in some cases, King County.

Design Criteria

The following steps must be taken to minimize risk:

- Locate temporary storage area away from vehicular traffic, near the construction entrance(s), and away from drainage channels or storm drains.
- Keep ~~Material~~ Safety Data Sheets (MSDS) on site for all materials stored. Keep chemicals in their original labeled containers.
- Minimize hazardous material storage on site.
- Handle hazardous materials as infrequently as possible.
- During the wet weather season (October 1 to April 30), consider storing materials in a covered area.
- Do not store chemicals, drums, or bagged materials directly on the ground. Place these items on a pallet and, when possible, in secondary containment.

- If drums must be kept uncovered, store them at a slight angle to reduce ponding of rainwater on the lids to reduce corrosion. Domed plastic covers are inexpensive and snap to the top of drums, preventing water from collecting.
- Store materials with secondary containment, such as a curbed paved area, pallets with built-in containment, or even a children's wading pool for non-reactive materials such as detergents, oil, grease, and paints. Small amounts of material may be secondarily contained in "bus boy" trays or concrete mixing trays.
- Use spill prevention and control measures for maintenance, fueling, and repair of heavy equipment and vehicles. Clean contaminated surfaces immediately following any spill incident.
- Provide cover, containment, and protection from vandalism for all chemicals, liquid products, petroleum products, and other materials that have the potential to pose a threat to human health or the environment. Include secondary containment for onsite fueling tanks.

Secondary Containment Practices:

- Store all hazardous substances with a listed Reportable Quantity in approved containers and drums and in secondary containment. The list of Reportable Quantities is available [on the U.S. Environmental Protection Agency's \(U.S. EPA's\) website: \(www2.epa.gov/superfund\)](http://www2.epa.gov/superfund).
- Provide temporary secondary containment facilities with a spill containment volume able to contain precipitation from a 25-year, 24-hour storm event plus 10 percent of the total enclosed container volume of all containers; or 110 percent of the capacity of the largest container within its boundary, whichever is greater.
- Provide sufficient separation between stored containers to allow for spill cleanup and emergency response access.
- During the wet weather season (October 1 to April 30), cover each secondary containment facility during non-working days, prior to and during rain events.
- Provide secondary containment facilities that are impervious to the materials stored for a minimum contact time of 72 hours.

Maintenance

- Keep secondary containment facilities free of accumulated rainwater and spills. In the event of spills or leaks, collect accumulated rainwater and spills and place into drums. Treat these liquids as hazardous waste unless testing determines them to be non-hazardous.
- Keep material storage areas clean, organized and equipped with an ample supply of appropriate spill clean-up material (spill kit). For spill prevention and cleanup requirements, including spill kit instructions, refer to *Volume 4 – Source Control*.

5.1.2. *BMP C1.20: Use of Chemicals During Construction*

Description

Best practices for control, storage, cleaning and disposal of all chemicals used at a project site that may potentially pollute stormwater.

Purpose

A large percentage of potential pollutants from chemicals can be effectively controlled at project sites through implementation of source control and soil erosion and sedimentation control practices.

Conditions Where Practice Applies

This BMP applies to most project sites since many types of chemicals may be used during construction activities. These chemical pollutants include paints, acids, cleaning solvents, asphalt products, soil additives, concrete-curing compounds, and many others. These materials can be carried by sediment and water runoff from project sites.

Planning Considerations

Disposal of concrete products, additives, and curing compounds depends on the product. Some liquid wastes must be stored and handled according to special guidelines and may require a permit. Follow the regulations and requirements outlined by Ecology and, in some cases, King County.

Refer to *Volume 4 – Source Control* to see if additional source controls are required.

Design Criteria

- As in the case of other pollutants, good housekeeping is the most important means of controlling pollution.
- Use only the recommended amounts of chemical materials and apply them in a proper manner to further reduce pollution.
- Acid and alkaline solutions from exposed soil or rock units high in acid and alkaline-forming natural elements should be controlled using good site planning and preconstruction geological surveys. Refer to BMP C1.56 Concrete Handling and Disposal. Neutralization of these pollutants often provides the best treatment.
- The City requires project site operators to adjust the pH of stormwater if necessary to prevent violations of water quality standards. Refer to BMP C1.59 High pH Neutralization Using CO₂.
- Chemicals used in batch treatment or flow-through treatment must be approved in writing by Ecology prior to use. Formal approval from the City is based on Ecology's protocols. For a list of treatment chemicals that have been evaluated and are currently approved for use by Ecology [visitrefer to the Department's website: \(https://ecology.wa.gov/Regulations-Permits/Guidance-technical-assistance/Stormwater-permittee-guidance-resources/Emerging-stormwater-](https://ecology.wa.gov/Regulations-Permits/Guidance-technical-assistance/Stormwater-permittee-guidance-resources/Emerging-stormwater-)

[treatment-
technologieswww.ecy.wa.gov/programs/wq/stormwater/newtech/index.html](http://www.ecy.wa.gov/programs/wq/stormwater/newtech/index.html)).

- For paint disposal, the correct method of wastes varies with the material:
 - Wash-up waters from water-based paints may go into a sanitary sewer, which is regulated by the King County Industrial Waste Program (206) 263-3000.
 - Wastes from oil-based paints, cleaning solvents, thinners, and mineral spirits must be disposed of through a licensed waste management firm or treatment, storage, and disposal (TSD) facility.

Maintenance

- Seal fractures in the bedrock with grout and bentonite will reduce the amount of acid or alkaline seepage from excavations.
- Adequate treatment and disposal of concrete further reduces pollution.

5.1.3. *BMP C1.25: Demolition of Buildings*

Description

Methods used to protect stormwater from pollution associated with the removal of existing buildings (and clearing of the rubble) by means of controlled explosions, wrecking balls, or manual methods.

Purpose

The loose debris produced by building demolition activities can contain toxic organic compounds, metals, and suspended solids that may pollute stormwater. Toxic organic compounds, including PCBs, may be present in buildings built or remodeled prior to 1980. Projects, regardless of size, shall implement practices to properly handle and dispose of materials that may contain PCBs such as transformers, light ballasts, caulk and some roofing materials so that they do not come into contact with stormwater.

Conditions Where Practice Applies

Complete or partial building demolition, structure demolition, or other activity that requires controlled explosions, wrecking balls, or manual methods to demolish a structure, and/or clearing of demolition rubble.

Planning Considerations

This BMP is intended to provide basic information to protect stormwater from being polluted by demolition debris. However, demolition of buildings is regulated in Washington by Ecology and the Puget Sound Clean Air Agency (PSCAA). Refer to Ecology's [web page "Manage Construction and Demolition Waste"](#) [web page](#) for additional requirements (<https://ecology.wa.gov/Regulations-Permits/Guidance-technical-assistance/Dangerous-waste-guidance/Common-dangerous-waste/Construction-and-demolition>www.ecy.wa.gov/programs/hwtr/dangermat/demo_debris_constr_materials.html) and PSCAA's [website](#) for other information and requirements (www.pscleanair.gov/185/Asbestoswww.pscleanair.org/business/Asbestos/Pages/default.aspx).

Design Criteria

- Protect the drainage system from sediment-laden runoff and loose particles. To the extent possible, use dikes, berms, or other methods to protect overland discharge paths from runoff.
- Sweep street gutters, sidewalks, driveways, and other paved surfaces in the immediate area of the demolition daily to collect and properly dispose of loose debris and garbage.
- Spray water, such as from a hydrant or water truck, to help control windblown fine materials such as soil, concrete dust, and paint chips. Control the amount of water so that runoff from the site does not occur, yet dust control is achieved. Never use oils for dust control.
- Schedule demolition to take place during a dry time of the year.

Maintenance

Clean up debris on a regular basis to prevent stormwater contamination.

5.1.4. BMP C1.30: Building Repair, Remodeling, and Construction

Description

Best practices for the control of pollutants associated with construction of buildings and other structures such as, but not limited to, remodeling of existing buildings and houses, and general repair work on building exteriors.

Purpose

Pollutants of concern may be generated during building repair, remodeling, and construction, including petroleum hydrocarbons, organic compounds, suspended solids, metals, pH, and oils and greases.

Conditions Where Practice Applies

When buildings and/or structures are repaired, remodeled, and constructed.

Planning Considerations

Educating employees about the need to control site activities is one of the most effective methods to prevent stormwater pollution.

Design Criteria

- Use ground cloths or drop cloths underneath activities.
- Use drain covers or similarly effective devices if dust, grit, washwater, or other pollutants may impact onsite or downstream offsite catch basins. Collect and dispose of the accumulated sediment-laden runoff and solids before the cover is removed.
- Clean all tools in an inside sink that drains to the sanitary sewer. If cleaning must be done outside, collect all wastewater and dispose of properly.
- Clean non-water-based finishes from tools in a manner that allows the collection of used solvents for recycling or proper disposal.
- Water can be sprayed to help control windblown fine materials such as soil, concrete dust, and paint chips. Control the amount of water so that runoff from the site does not occur, yet dust control is achieved. Never use oils for dust control.
- [In the Shoreline District, as defined by SMC Chapter 23.60A Seattle Shoreline Program Regulations, comply with the provisions of SMC 23.60A.152 and SMC 23.60A.155 or the current Shoreline Master Program code.](#)
- [Construction and repair work shall use BMPs to prevent the entry of debris and other waste materials into any water body. Any cleaning, sanding, cutting of treated wood, or resurfacing operation occurring over water or in water shall be performed with tarpaulins, decking, or similarly effective materials securely affixed above the water line to prevent material from entering the water. Before the tarpaulins, decking, or similarly effective materials are removed, the accumulated contents shall be removed by vacuuming or an equivalent method that prevents material from entering the water.](#)

- [No over-water or in-water application of paint, preservative treatment, or other chemical compounds is permitted, except in accordance with BMPs to prevent the compounds from entering the water.](#)
- [In addition to the BMPs to prevent debris and chemical compounds from construction, remodeling, and repair work from entering water bodies, a secondary containment system \(e.g., floating containment boom\) is required for work over water or in water. Additional requirements may apply, as required by local, state, and federal regulations.](#)
- [Construction staging areas shall be as far from the water bodies on the site as possible.](#)

Maintenance

- Maintain drain covers regularly (weekly or as needed) to prevent plugging.
- Recycle materials whenever possible.

5.1.5. BMP C1.35: Sawcutting and Paving Pollution Prevention

Description

Best practices to minimize and eliminate wastewater and slurry from sawcutting and paving operations including, but not limited to, the following:

- Sawing
- Surfacing
- Coring
- Grinding
- Roughening
- Hydro-demolition
- Bridge and road surfacing

Purpose

Sawcutting and paving operations generate slurry and wastewater that contain fine particles and high pH, both of which can violate the water quality standards in receiving waters.

Conditions Where Practice Applies

Any time sawcutting or paving operations take place.

Planning Considerations

This BMP is intended to minimize and eliminate wastewater and slurry from entering the public drainage control system and receiving waters. Wastewater may be permitted to be discharged to a sanitary sewer, which is regulated by Seattle Public Utilities and the King County Industrial Waste Program (206) 263-3000.

Design Criteria

- Vacuum slurry and cuttings during the activity to prevent migration off site. Do not allow slurry and cuttings to remain on permanent concrete or asphalt paving overnight.
- Dispose of collected slurry and cuttings in a manner that does not violate groundwater or surface water quality standards.
- Do not drain wastewater that is generated during hydro-demolition, surface roughening, or similar operations to any natural or constructed drainage conveyance. Dispose of wastewater in a manner that does not violate groundwater or surface water quality standards.
- Clean and dispose of waste material and demolition debris in a manner that does not cause contamination of water. If the area is swept with a pick-up sweeper, haul out the material to an appropriate disposal site.

Maintenance

Continually monitor operations to determine whether slurry, cuttings, or wastewater could enter the public drainage system or the public sewer. If inspections show that a violation of water quality standards could occur, stop operations and immediately implement preventative measures such as berms, barriers, secondary containment, and vacuum trucks.

5.1.6. *BMP C1.40: Temporary Dewatering*

Description

The removal and appropriate discharge and release of groundwater, whether it is from a simple trench or a large excavation.

Purpose

Temporary dewatering is used when groundwater needs to be removed before certain operations can be performed, or to keep work conditions safe. It is typical for contractors to use ditch pumps and/or well points to dewater, but it is very important to identify and use the appropriate locations for discharge. Dewatering may require a temporary BMP for settling and/or filtering sediment-laden water. A temporary sediment pond or other equivalent facility is used to settle and/or filter the water. Properly designed and implemented temporary dewatering will:

- Prevent the discharged water from eroding soil on site
- Remove sediment from the collected water
- Choose the best location for discharge
- Preserve downstream natural resources and real property

Projects which are required to comply with Minimum Requirements for Flow Control (SMC 22.805.080) must account for dewatering discharge in determining an allowable release rate.

Conditions Where Practice Applies

Public or private properties with the following:

- Foundation excavations
- Utilities and infrastructure construction projects, including installation, repair and maintenance of:
 - Electrical conduits
 - Vaults/tanks
 - Sanitary sewer and public drainage systems
 - Phone and cable lines
 - Gas or other fuel lines
 - Other excavations or graded areas requiring dewatering

Clean, non-turbid dewatering water, such as well-point groundwater, may be discharged to the public combined sewer; systems tributary to receiving waters; or directly into receiving waters, provided the dewatering flow is discharged to a stabilized system and does not cause erosion or flooding of receiving waters [or downstream systems](#). Clean dewatering water should not be routed through stormwater sediment ponds.

If dewatering must occur, a Side Sewer Permit for Temporary Dewatering (SSPTD) and a Discharge Authorization Letter from King County Industrial Waste may be required prior to commencing dewatering at the site. The SSPTD permit may include a separate Temporary Dewatering Plan, water quality treatment, and/or flow control requirements, as well as compliance monitoring requirements.

For a copy of the SSPTD “Tip ~~503506~~,” go to the [Seattle Department of Construction and Inspections \(SDCI\)](#) Public Resources Center on the 20th floor of the Seattle Municipal Tower, 700 Fifth Avenue, Seattle, Washington 98124 (~~same location as above~~), or ~~visit~~refer to SDCI’s [TipsCAM](#) web ~~page~~site (<http://web1.seattle.gov/DPD/CAMs/CamList.aspx>).

Planning Considerations

Prior to implementing temporary dewatering, minimize the amount of water that will be collected and the potential amount of sediment that may enter the water. Implement the following prior to temporary dewatering:

- For trench excavation, limit the trench length to 150 feet and place the excavated material on the up-gradient side of the trench.
- Install diversion ditches or berms to minimize the amount of clean stormwater runoff allowed into the excavated area.
- Dewatering in periods of intense, heavy rain, when the infiltrative capacity of the soil is exceeded, should be avoided.
- Never discharge to bare or newly vegetated areas.

Once the site has been prepared as described above, assess the site for the issues listed below to assist the City in determining which discharge option to approve:

- Water clarity. If the water is turbid (cloudy), there are dissolved and/or settleable solids in the water that should be filtered or settled out prior to discharge. Determine if contaminants are present in impounded water. Check for odors, discoloration, or oily sheen. Check any soils and/or groundwater testing results.
- If contamination may be or is present, the Director of SPU reserves the right to require sampling and analysis to prove that water quality is being protected. Highly turbid or contaminated dewatering water should be handled separately from stormwater. Contaminated groundwater is a prohibited discharge; however, it may be treated to become a permissible discharge if metals and other pollutants are mitigated to meet concentration thresholds in state water quality standards. If no such water quality standards exist for a pollutant, discharge limits should be based on the stricter standard of any other appropriate and relevant water quality criteria (i.e., Washington State water quality standards, U.S. EPA national recommended water quality criteria for aquatic life and human health, and the National Toxics Rule).
- Depending upon the type of downstream infrastructure and the desired discharge volume, the dewatering discharge flow rate may be required to be limited to a daily (measured by gallons or cubic feet per day) or instantaneous (measured by gallons or cubic feet per second) maximum.

Design Criteria

One of several types of dewatering facilities may be constructed, depending upon site conditions and the type of activities.

Water Removal

The removal of water from the excavated area can be accomplished by numerous methods. The most common of these are:

- Gravity drain through a daylight channel
- Mechanical pumping
- Siphoning
- Using the appropriate construction equipment to scoop and dump water from the excavation

Stabilize channels or any conveyance feature dug for discharging water from the excavated area. If flow velocities cause erosion within the channel, install a ditch lining, such as geotextile or heavy plastic sheeting.

Discharge Structure

Water conveyed by channels, ditches, pumps, hose, or equipment buckets should be discharged in a regulated manner to a stable ~~discharge~~ structure. The structure must be:

- Appropriate to filter sediment
- Able to withstand the velocity of the discharged water to prevent erosion
- Sized and operated such that pumped water will flow through an ~~sediment removal~~ energy dissipation device and converted to gravity flow prior to discharge to a downstream system
- Not overtop the structure

Typical constructed areas are:

- Sediment traps (refer to BMP E3.40)
- Portable sediment tanks (refer to BMP E3.50)
- Enclosure of hay bales, filter fabric (refer to BMP E3.10), or both
- Sediment filter bag

Sediment Removal – General

Sediment ~~must should~~ be settled prior to discharge. All settling systems should be engineered and adequately sized for site conditions. Sediment removal is required when establishing wells for well-point dewatering but may be removed once the well and filter pack are established, and the discharge is found to be clean and non-turbid. General settling and filtering options include the following:

- Containment in a pond structure for a minimum of 4 hours or until water is clear (time will vary greatly depending upon gradation of sediment). Place a pump in a gravel bed at the bottom of the pond.
- Discharge to a manufactured / pre-made structure specifically designed for sediment removal, like a Silt Sak, Silt Bag, or other similar product. Pump to a settling tank with sampling ports.
- Transport off site in vehicle, such as a vacuum flush truck, for legal disposal.
- Filter through a sieve or other filter media (e.g., swimming pool filter). Simple onsite filter systems can be constructed including: wrapping the ends of the suction and discharge pipes with filter fabric; discharging through a series of drums filled with successively finer gravel and sand; and other filtering techniques like those described under [storm drain](#) inlet protection (BMP E3.25).
- Manufactured bags, polymers, or other systems. These systems do not always work on fine clay soils, and will only be allowed for use where approved. Chemical treatments should have state approval before they are used (refer to Ecology BMP C250 Construction Stormwater Chemical Treatment [and Appendix B](#)).
- Line or protect the flowpath in some way to prevent mobilization of additional sediment.
- Dry and reuse filtered material on site in a mixture with other site soils, or appropriately dispose of the material based on nature and levels of any contaminants present.

Vegetated Buffer

A well stabilized, onsite, vegetated area may serve as a dewatering facility if the area is appropriate to filter sediment and at the same time withstand the velocity of the discharged water without erosion. The discharge of sediment-laden water onto a vegetated area must not pose a threat to the survival of the existing vegetative stand through smothering by sedimentation.

Direct discharge of lightly sediment bearing water may be able to go directly into well-buffered areas with a 2 percent slope as long as a method of spreading flow into sheet flow is available.

Straw Bale/Filter Fabric Pit

An excavated or bermed sedimentation pond or structure can also be created using straw bale and filter fabric (refer to BMP E3.10 Filter Fence) to create a pit. Flow to the structure may not exceed the sediment removal structure's capacity to settle and filter flow or the structure's volume capacity. Wherever possible, the structure should also discharge to a well-vegetated buffer through sheet flow, should maximize the distance to the nearest receiving water, and should minimize the slope of the buffer area. Also, the excavated portion may need to be lined with geotextile to help reduce scour and to prevent the inclusion of soil from within the structure (refer to BMP E3.40 Sediment Trap).

Sediment Filter Bag

The filter bag should be constructed of non-woven geotextile material that will provide adequate filtering ability to capture larger soil particles from the pumped water. The bag

should be constructed so that there is an inlet neck that may be clamped around the dewatering pump discharge hose so that all of the pumped water passes through the bag.

The filter bag should be used in combination with a straw bale/~~filters~~ fence pit when located within 50 feet of a receiving water. When the distance is greater than 50 feet, the bag may be placed on well-established vegetation, or on an aggregate pad constructed of crushed rock at a minimum depth of 6 inches. The bag should never be placed on bare soil.

The capacity of the sediment filter bag should be adequate to handle the dewatering pump discharge, and should be based on the bag manufacturer's recommendation.

When used in conjunction with a straw bale/~~filters~~ fence pit, a filter bag may be operated until the water in the pit reaches the crest of the emergency overflow. The pump must be shut off at this point. When placed on either a rock pad or well-established vegetation, the bag may be operated until the discharge from the bag reaches a receiving water. Unless the discharge is at least as clear as the receiving water, the pump must be shut off at this point.

When the bag has been completely filled with sediment, it should be cut open, re-graded in place, and immediately stabilized with either sod or erosion control mat.

Maintenance

- Check filtering devices frequently to make sure they are unclogged and operating correctly. Pay special attention to the buffer area for any sign of erosion and concentration of flow that may compromise the buffer area. Where possible, observe the visual quality of the effluent and determine if additional treatment can be provided.
- Make adjustments depending on the amount of sediment in the water being pumped.
- Repair and/or replace any equipment that does not function as designed.
- The accumulated sediment which is removed during maintenance must be spread on site and stabilized or disposed of at an approved disposal site.
- Systems should be filled in or otherwise removed when permanent dewatering controls are in place and connected to an approved treatment and receiving system.

5.1.7. BMP C1.45: Solid Waste Handling and Disposal

Description

Methods used to protect stormwater from pollution associated with the management, handling and disposal of all solid waste generated on a project site.

Purpose

Solid waste is one of the major pollutants caused by construction and can have direct impacts to stormwater as a potential pollutant if not managed and disposed of properly. Solid waste includes the following:

- Trees and shrubs removed during land clearing
- Wood and paper used in packaging and building materials
- Scrap metals and metal shavings
- Sanitary wastes
- Rubber, plastic, and glass pieces
- Masonry products
- Leftover food, food containers, beverage cans, coffee cups, lunch wrapping paper, aluminum foil, and plastic
- Cigarette packages and butts
- Unwanted or discarded construction and demolition products

Conditions Where Practice Applies

All project sites.

Planning Considerations

The major control mechanism for these pollutants is to provide adequate disposal facilities.

Design Criteria

- Collection containers: Project sites should have at least two containers; one for garbage or non-recyclable construction wastes and the other for recycling. Multiple containers for source-separated recyclables, such as clean wood and metal, are encouraged. Source-separating recyclables on the site means more recycling, less waste, and generally lower tipping fees/disposal costs. All containers located on the job site should be clearly marked, labeled with a list of acceptable materials, and kept closed when not in use. Any container designated for recycling should have at least 90% of its contents be recyclable and no garbage or items not accepted by the receiving facility. Garbage should not be deposited in a container designated for construction waste or for recycling.
- Remove garbage frequently to maintain project sites in a clean and attractive manner. Remove and dispose of accumulated solid waste at authorized disposal areas.

- Label waste containers and locate them in a covered area. Keep lids closed at all times.
- The City requires the recycling of readily recyclable construction and demolition waste materials and submittal of a Waste Diversion Report per SMC 21.36.089 and subsequent SPU Director's Rules related to construction materials disposal bans. In addition, the Seattle Department of Construction and Inspection now requires that a Waste Diversion Plan be part of the permit application for a building permit if the project is 750 square feet or greater and that a Salvage Assessment be performed for any job involving demolition. At the end of each project a Waste Diversion Report must be submitted to Seattle Public Utilities that documents through facility weight receipts where materials from the construction or demolition site went for reuse, recycling and disposal.
- Reuse and Recycling: Reuse on and off site reduces waste and is the most preferred method for handling materials. Several local firms provide salvage assessment and resale of building materials. Green building credits recognize reuse as well as recycling.
- Hauling: Reusables and recyclables may be hauled by any company you choose or you may "self-haul" yourself. Non-recyclable construction waste such as painted and treated wood or fiberglass insulation must be hauled only by the City's contracted hauler, Waste Management; or you may "self-haul" yourself to the appropriate receiving facility.
- Recyclable Materials from Project Sites: Current and future targeted materials and their handling, hauling and destination requirements are listed in Table 9.
- For more information about the City's construction [and demolition](http://www.seattle.gov/utilities/businesses-and-key-accounts/construction/construction-waste) waste recycling requirements, [refer to the City's website: \(www.seattle.gov/utilities/businesses-and-key-accounts/construction/construction-waste\)](http://www.seattle.gov/utilities/businesses-and-key-accounts/construction/construction-waste).
- For assistance with finding recycling facilities, [refer to the King County Green Tools web page at: \(https://kingcounty.gov/depts/dnrp/solid-waste/programs/green-building.aspx\)](https://kingcounty.gov/depts/dnrp/solid-waste/programs/green-building.aspx).
- For assistance in determining where to take motor oil, pesticides, smoke alarms, fluorescent bulbs, and other hazardous materials, [refer to the Local Hazardous Waste Management Program website: \(www.hazwastehelp.com\)](http://www.hazwastehelp.com).
- Selective (rather than wholesale) removal of trees is helpful in conservation of soil and reduction of wood wastes. Avoid indiscriminate removal of trees and other beneficial vegetation.

Table 9. Handling, Hauling, and Destination Requirements for Targeted Materials.

Targeted Materials	Banned from Disposal	Collection Method and Hauling	Facilities ^{*a}
Land Clearing (such as trees, shrubs, stumps)	Yes	<ul style="list-style-type: none"> Self-haul or Order drop box from a private recycler Grind and use on site 	<ul style="list-style-type: none"> City transfer stations Private drop sites for yard waste Composting facilities Wood waste recyclers
Asphalt Paving	Yes	<ul style="list-style-type: none"> Self-haul or Order drop box from a private hauler or recycler 	<ul style="list-style-type: none"> Concrete recyclers Sand and gravel operations Mixed waste recyclers
Bricks	Yes, if whole	<ul style="list-style-type: none"> Reuse on or off site Self-haul to a reuse store or private recycler 	<ul style="list-style-type: none"> Reuse stores Sand and gravel operations
Concrete	Yes, if unpainted	<ul style="list-style-type: none"> Reuse on or off site as fill only if appropriate for groundwater conditions Self-haul 	<ul style="list-style-type: none"> Concrete recyclers, Sand and gravel operations Mixed waste recyclers
Cardboard and Paper	Yes	<ul style="list-style-type: none"> Use City provided curbside recycling containers or commercial recycling cart service if available for the building site Self-haul 	<ul style="list-style-type: none"> City transfer stations Many private recyclers
Metal (ferrous and non-ferrous)	Yes	<ul style="list-style-type: none"> Use City provided curbside recycling container if available for building site Self-haul 	<ul style="list-style-type: none"> City transfer stations Many private recyclers
New Construction Gypsum Scrap	Yes	<ul style="list-style-type: none"> Self-haul Drop box from a private recycler 	<ul style="list-style-type: none"> Drywall recyclers Mixed waste recyclers
Carpet	Yes, starting in July 2022^b Possibly in 2015	<ul style="list-style-type: none"> Self-haul Drop box from a private hauler or recycler 	<ul style="list-style-type: none"> Take back offered through flooring stores for installers Some mixed waste recyclers if clean
Plastic Film Wrap	Yes, starting in July 2022^b 2015 for clean film	<ul style="list-style-type: none"> Self-haul Drop box from a private hauler or recycler 	<ul style="list-style-type: none"> Mixed waste recyclers if clean
Wood	Yes, 2015 for if unpainted and untreated wood over 6 inches in length	<ul style="list-style-type: none"> Self-haul Drop box from a private hauler or recycler 	<ul style="list-style-type: none"> City transfer stations Private drop sites and recycling facilities
Tear-off Asphalt Roofing Shingles	Yes, starting in July 2022^b Possibly in 2015	<ul style="list-style-type: none"> Self-haul to a private recycler 	<ul style="list-style-type: none"> Private asphalt shingle recyclers Some mixed waste recyclers

Table 9 (continued). Handling, Hauling, and Destination Requirements for Targeted Materials.

Targeted Materials	Banned from Disposal	Collection Method and Hauling	Facilities*
Food Waste (such as from lunches)	Yes ^a for food, but not the wrappings or containers	<ul style="list-style-type: none"> • Use City provided curbside organics container or commercial cart service if available for the building site 	
Tin and Aluminum Cans: Glass and Plastic Bottles and Jars	Yes	<ul style="list-style-type: none"> • Use City provided curbside recycling container or commercial recycling cart service if available for the building site • Self-haul 	<ul style="list-style-type: none"> • City transfer stations • Private recyclers
Cups	Yes	<ul style="list-style-type: none"> • Use City provided curbside recycling container or commercial recycling cart service if available for the building site 	<ul style="list-style-type: none"> • City transfer stations • Private recyclers
Other Non-Recyclable Waste Materials		<ul style="list-style-type: none"> • Self-haul to City transfer stations for disposal • Order a container from Waste Management, the City's contractor for the hauling of non-recyclable construction wastes at 1-800-592-9995 	

^a For a list of construction waste recycling facilities, refer to [the City's website: \(www.seattle.gov/utilities/businesses-and-key-accounts/construction/construction-waste/recycling-requirements/certified-facilities\)](http://www.seattle.gov/utilities/businesses-and-key-accounts/construction/construction-waste/recycling-requirements/certified-facilities) www.seattle.gov/util/ForBusinesses/Construction/CDWasteManagement/RecyclingRequirements/CertifiedFacilities.

^b Refer to Director's Rule SW-640 (formerly DR SW-405.3) for the effective date for bans on carpet, plastic film wrap, and tear-off asphalt roofing shingles.

Maintenance

Soil erosion and sediment control structures capture much of the solid waste from project sites. Frequently remove litter from these structures to reduce the amount of solid waste despoiling the landscape.

5.1.8. BMP C1.50: Disposal of Asbestos and Polychlorinated Biphenyls (PCBs)

Use and disposal of these potential pollutants are regulated by both state and federal agencies. For further information, contact:

- For asbestos:
 - Puget Sound Clean Air Agency (<https://pscleanair.gov>~~www.pscleanair.org~~) (206) 343-8800 or toll-free (800) 552-3565
 - U.S. EPA (www.epa.gov/asbestos) (206) 553-1200 or toll-free (800) 424-4EPA
- For wastes containing PCBs:
 - Washington Department of Ecology, Hazardous Waste Section: (206) 449-6687
 - U.S. EPA (<https://www.epa.gov/hw>~~www.epa.gov/osw/hazard/tsd/pcbs/~~) (206) 553-1200 or toll-free (800) 424-4EPA

5.1.9. BMP C1.55: Airborne Debris Curtain

Description

Using plastic or other material to create a vertical barrier, or curtain, around a building or other structure undergoing exposed construction, or cleaning activities to minimize the spread of airborne debris.

Purpose

Activities related to exposed building construction, repair, or cleaning include spraying, pressure washing, surface preparation, sand blasting, paint removal, sanding, and painting. If conducted outdoors, all of these activities are associated with high risk for contaminating water resources.

Potential pollutants include spent fire retardants, abrasive grits, solvents, oils, washwater, paint overspray, cleaners and detergents, paint chips, glass fibers, and dust. Pollutant constituents include suspended solids, oils and greases, organic compounds, copper, lead, tin, and zinc.

Conditions Where Practice Applies

This BMP should be implemented when spraying, blasting, sanding, or washing outdoors.

Planning Considerations

- Relocate maintenance and repair activities that can be moved indoors to reduce the potential for direct pollution of stormwater.
- Evaluate disposal methods for spent abrasives, cleaners, etc.
- Consider using no soaps or detergents. Brush the exterior surface with water only.

Despite what is on the label, the term biodegradable does not mean that the product is safe or environmentally friendly. Some cleaning products may degrade eventually, but are still harmful to the environment.

Design Criteria

- Use fixed platforms with appropriate plastic or tarpaulin barriers as work surfaces and for containment when work is performed near a receiving water. This helps to prevent material or overspray from coming into contact with stormwater or the receiving water.
- Use sanders that have dust-containment bags and avoid sanding in windy conditions.
- Store materials such as paints, tools, and ground cloths indoors or in a covered area when not in use.
- Contain blasting and spraying activities by hanging tarpaulins to block the wind and prevent dust and overspray from escaping. Do not perform uncontained spray painting, blasting, or sanding activities over open water without proper protection (e.g., overspray collection, drop clothes, booms).

- Use plywood and/or plastic sheeting to cover open areas when sandblasting.
- During painting, finishing, or sand blasting, use ground cloths to collect drips, spills, paint chips, and used blasting sand.
- Avoid collecting debris in areas subject to foot or vehicular traffic to control tracking.

Maintenance

- Collect spent abrasives and other waste materials regularly. Contain and store them under cover until they can be disposed of properly.
- At least once each week or more often as needed, sweep and clean ground surface areas. Do not hose them down. Properly dispose of the collected materials.
- Use one of the following treatment BMPs when paint chips or blasting grit are present in the work area:
 - Cleaning Inlets and Catch Basins (BMP E3.65)
 - Street Sweeping and Vacuuming (BMP E3.70)
 - ~~Storm Drain~~ Inlet Protection (BMP E3.25). Use filtration with media designed for the pollutants present.

Catch basin filters only remove solids and do not provide treatment for other pollutants associated with some building cleaning activities.

5.1.10. BMP C1.56: Concrete Handling and Disposal

Description

~~Methods for control, containment, removal and disposal of concrete materials and waste products to prevent contamination of storm drains, open ditches, or critical areas, such as water bodies and wetlands. Concrete work includes storingstorage, mixing, pouring, placementplacing, finishing, removalremoving, saw cutting, or clean-up of concrete materials, theslurry, or process water associated with these activities, and the proper construction of a contained area on a project site where concrete and concrete wastewater and washout may be stored for later disposal.~~

Purpose

To prevent or reduce the discharge of fine particles and high pH process water and slurry from concrete materials. Concrete spillage or concrete discharge to waters of the state is prohibited.

Conditions Where Practice Applies

Anytime concrete is used, removed, or disposed of, including, but not limited to, placement and maintenance of:

- Ceurbs,
- Sidewalks,
- Roads,
- Bridges,
- Foundations,
- Floors, and
- Runways.

Anytime cured or uncured concrete is used, removed or disposed of, or water that has come in contact with uncured concrete is present, it must be disposed of properly. Activities that use, remove, or dispose of concrete include, but are not limited to, sawing slurry, coring, grinding, roughening, hydro-demolition, bridge and road surfacing.

Planning Considerations

~~Sawcutting and surfacing operations generate slurry and process water that contains fine particles and high pH (concrete cutting), both of which can violate the water quality standards in the receiving water. Concrete spillage or concrete discharge to receiving waters is prohibited. Use this BMP to minimize and eliminate process water and slurry created through sawcutting or surfacing from entering receiving waters. Utilize these management practices anytime sawcutting or surfacing operations take place.~~

Washwater and stormwater that has contacted uncured cement will become high-pH waters, which must be collected and treated before release to the public drainage system or public combined sewer. Concrete should not be placed during heavy rain events.

Wash concrete truck drums and other concrete handling equipment at an approved offsite location or in designated concrete washout areas only. Do not wash out concrete trucks on the ground (including formed areas awaiting concrete) or into storm drains, open ditches, streets, or streams. Refer to BMP C1.58 for information on concrete washout areas.

Refer to BMP C1.59 for pH adjustments requirements. Refer to the Construction Stormwater General Permit for pH monitoring requirements if the project involves one of the following activities:

- Significant concrete work (greater than 1,000 cubic yards poured concrete or recycled concrete used over the life of a project)
- The use of engineered soils amended with (but not limited to) Portland cement-treated base, cement kiln dust, or fly ash
- Discharge of stormwater to receiving waters on the 303(d)list (Category 5) for high pH

Education:

- Discuss the concrete management techniques described in this BMP with the ready-mix concrete supplier before any deliveries are made.
- Educate employees and subcontractors on the concrete waste management techniques described in this BMP.
- Arrange for contractor's superintendent or CESCL to oversee and enforce concrete waste management procedures.
- Install a sign adjacent to each temporary concrete washout ~~area~~ facility (BMP C1.58) to inform concrete equipment operators about utilizing the proper facilities.

Contracts:

Incorporate requirements for concrete waste management into concrete supplier and subcontractor agreements.

Design Criteria

- Within 15 feet of receiving waters, always use forms or solid barriers for concrete pours, such as pilings.
- Return unused concrete remaining in the truck and pump to the originating batch plant for recycling.
- ~~Do not dump excess concrete on site, except in designated concrete washout areas.~~
- ~~Ensure that washout of concrete trucks is performed off site or in designated concrete washout areas. If washout is done on site, wash out concrete truck chutes, pumps, and internals into formed areas only. Do not wash out concrete trucks onto the ground, or into storm drains, open ditches, streets, or streams.~~
- ~~Concrete washout areas may be prefabricated concrete washout containers, or self-installed structures (above grade or below grade).~~

- Prefabricated containers are most resistant to damage and protect against spills and leaks. Companies may offer delivery service and provide regular maintenance and disposal of solid and liquid waste.
- Use approximately 7 gallons of washwater or less to wash one truck chute.
- Use approximately 50 gallons of washwater or less to wash out the hopper of a concrete pump truck.
- Washout facilities ([BMP C1.58](#)) should be maintained to provide adequate holding capacity with a minimum freeboard of 12 inches.
- Washout facilities ([BMP C1.58](#)) must be cleaned, or new facilities must be constructed and ready for use once the washout is 75 percent full.

~~● If the washout is nearing capacity, vacuum and dispose of the waste material in an approved manner.~~

~~*Note: If less than 10 concrete trucks or pumbers need to be washed out on site, the washwater may be disposed of in a formed area awaiting concrete or an upland disposal site where it will not contaminate surface or groundwater. The upland disposal site must be at least 50 feet from critical areas such as storm drains, open ditches, or water bodies, including wetlands.*~~

- ~~● Vacuum slurry and cuttings during cutting and surfacing operations. Do not allow slurry and cuttings to drain to any natural or constructed drainage conveyance including stormwater systems. This may require temporarily blocking catch basins. Dispose of collected slurry and cuttings in a manner that does not violate ground water or surface water quality standards.~~
- Do not allow process water generated during hydro-demolition, surface roughening or similar operations to drain to any natural or constructed drainage conveyance including stormwater systems. Dispose of process water in a manner that does not violate ground-water or surface water quality standards.
- Wash off hand tools including, but not limited to, screeds, shovels, rakes, floats, and trowels into formed areas or into a designated concrete washout area ([BMP C1.58](#)) only.
- Handle and dispose of cleaning waste material and demolition debris in a manner that does not cause contamination of water. Dispose of sweeping material from a pick-up sweeper at an appropriate disposal site.
- Wash equipment difficult to move, such as concrete pavers, in areas that do not directly drain to natural or constructed stormwater conveyances.
- ~~● Do not allow washdown from areas, such as concrete aggregate driveways, to drain directly to natural or constructed stormwater conveyances.~~
- ~~● Never At no time shall concrete be washed off concrete into the footprint of an area where an infiltration feature will be installed.~~
- Contain washwater and leftover product in a lined container when no formed areas are available. Dispose of contained concrete in a manner that does not violate groundwater or surface water quality standards.
- The following steps will help reduce stormwater pollution from concrete wastes:
 - Do not allow excess concrete to be dumped on site, except in designated concrete washout areas.

- If self-installed concrete washout areas are used, below-grade structures are preferred over above-grade structures because they are less prone to spills and leaks. Self-installed above-grade structures should only be used if excavation is not practical.

5.1.11. BMP C1.58: Concrete Washout Area

Description

Methods for control, containment, removal, and disposal of concrete materials and waste products to prevent contamination of storm drains, open ditches, or critical areas, such as water bodies and wetlands. Concrete work includes storage, mixing, pouring, placement, finishing, removal, sawcutting, or cleanup of concrete materials, slurry, or process water associated with these activities. It also includes the proper construction of a contained area on a project site where concrete and concrete wastewater and washout may be stored for later disposal.

Purpose

Prevent or reduce the discharge of pollutants from concrete waste to stormwater by conducting washout off- site, or performing onsite washout in a designated area.

Conditions Where Practice Applies

Concrete washout areas are implemented on construction projects where:

- Concrete is used as a construction material.
- It is not possible to dispose of all concrete wastewater and washout off- site (ready mix plant, etc.).
- Concrete truck drums are washed on- site.

Note that auxiliary concrete truck components (e.g., chutes and hoses) and small concrete handling equipment, (e.g., hand tools, screeds, shovels, rakes, floats, trowels, and wheelbarrows) may be washed off into formed areas awaiting a concrete pour.

At no time shall concrete handling equipment be washed off into the footprint of a proposed area where an infiltration BMP will be installed.

Design Criteria

Location and Placement of Washout Areas

- Locate washout area at least 50 feet from storm drains, open ditches, or critical areas, such as water bodies and wetlands.
- Allow convenient access for concrete trucks, preferably near the area where the concrete is being poured.
- If trucks need to leave a paved area to access washout, prevent track-out with a pad of rock or quarry spalls (refer to BMP E2.10). These areas should be far enough away from other construction traffic to reduce the likelihood of accidental damage and spills.
- The number of washout facilities ~~you~~ installed should depend on the expected demand for storage capacity.

- On large sites with extensive concrete work, washouts [facilities](#) should be placed in multiple locations for ease of use by concrete truck drivers.
- [If the washout facility is nearing capacity, vacuum and dispose of the waste material in an approved manner.](#)

[Note: If less than 10 concrete trucks or pumpers need to be washed out on site, the washwater may be disposed of in a formed area awaiting a concrete pour or an upland disposal site where it will not contaminate surface water or groundwater. The upland disposal site must be at least 50 feet from critical areas such as storm drains, open ditches, or water bodies, including wetlands.](#)

- [Concrete washout areas shall be constructed and maintained in sufficient quantity and size to contain all liquid and concrete waste generated by washout operations.](#)

Onsite Temporary Concrete Washout Facility, Transit Truck Washout Procedures

- Locate temporary concrete washout facilities a minimum of 50 feet from critical areas including storm drain inlets, open drainage [BMPsfacilities](#), and receiving waters. Refer to Figures 20 and 21.
- Construct and maintain concrete washout facilities in sufficient quantity and size to contain all liquid and concrete waste generated by washout operations.
- Perform washout of concrete trucks in designated areas only.
- Concrete washout from concrete pumper bins can be washed into concrete pumper trucks and discharged into the designated washout area or properly disposed of off site.
- Once concrete wastes are washed into the designated area and allowed to harden, break up, remove, and dispose of the concrete per applicable solid waste regulations. Dispose of hardened concrete on a regular basis.

Temporary Above-Grade Concrete Washout Facility

- Construct temporary concrete washout facilities (type above grade) (refer to Figures 20 and 21), with a recommended minimum length and minimum width of 10 feet, but with sufficient quantity and volume to contain all liquid and concrete waste generated by washout operations.
- Use plastic lining material that is a minimum of 10 mil polyethylene sheeting and free of holes, tears, or other defects that compromise the impermeability of the material.

Temporary Below-Grade Concrete Washout Facility

- Construct temporary concrete washout facilities (refer to Figure 20, type “below-grade”) with a recommended minimum length and minimum width of 10 feet. The quantity and volume should be sufficient to contain all liquid and concrete waste generated by washout operations.
- Use commercial type lath and flagging.
- Use plastic lining material that is a minimum of 10 mil polyethylene sheeting and free of holes, tears, or other defects that compromise the impermeability of the material.
- Install liner seams should in accordance with manufacturers’ recommendations.

- Prepare soil base so that it is free of rocks or other debris that may cause tears or holes in the plastic lining material.

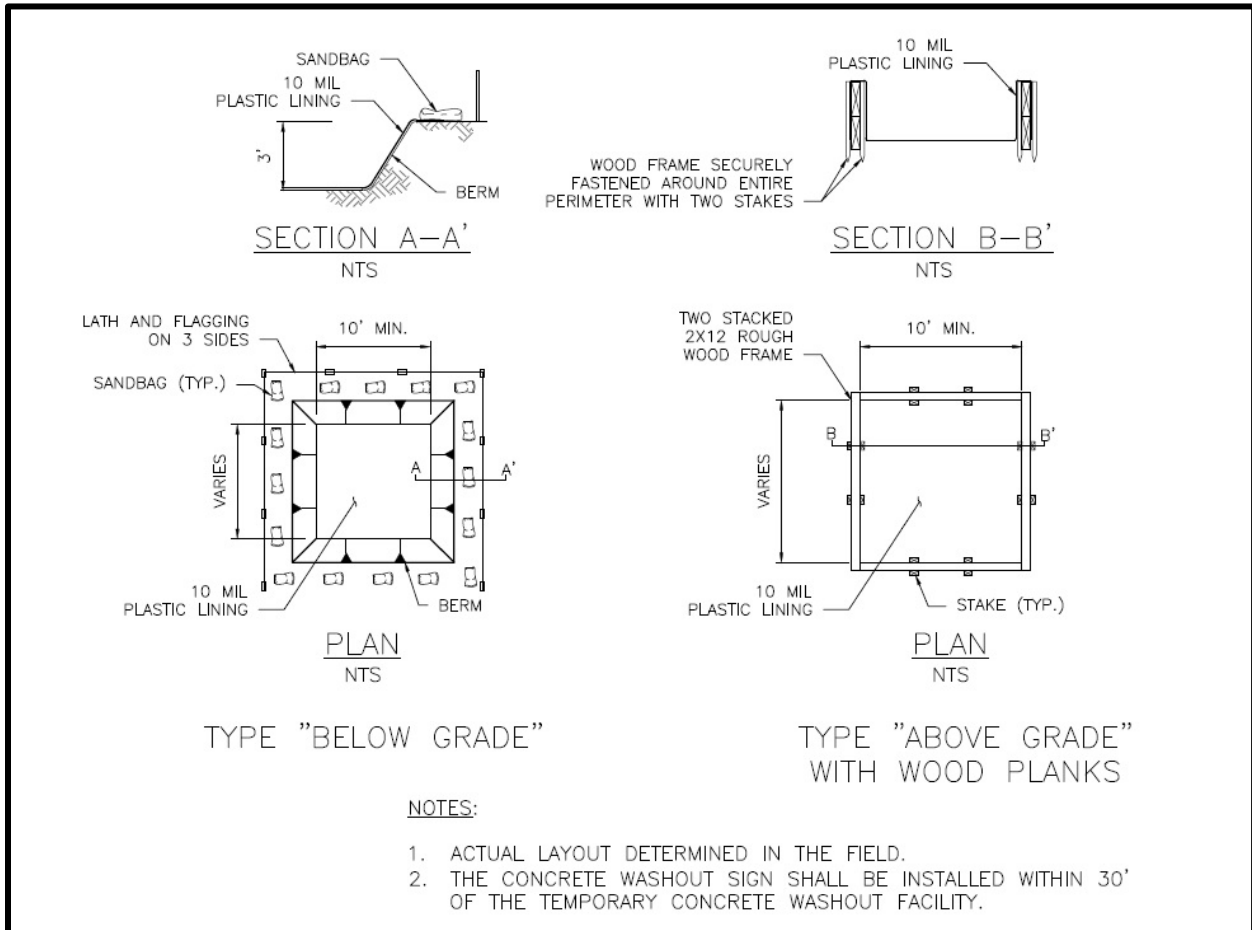

Figure 20. Concrete Washout Facility.

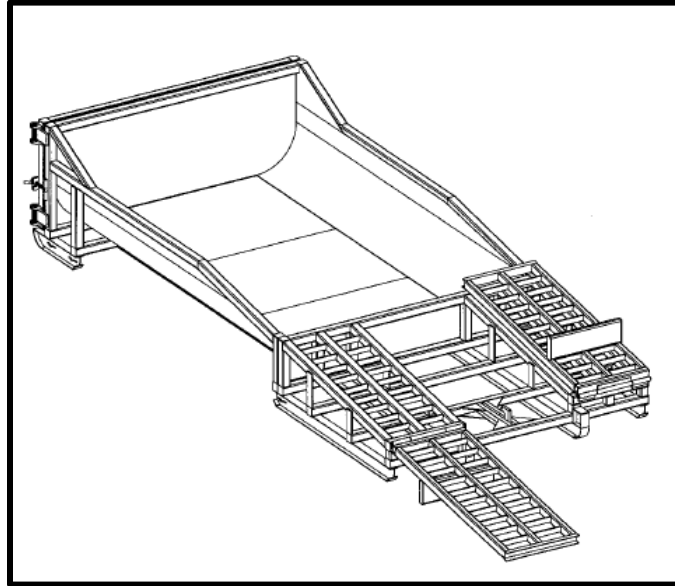

Figure 21. Prefabricated Concrete Washout Container with Ramp.

Maintenance

- Check containers for holes in the liner daily during concrete pours and repair the same day.
- Continually monitor operations to determine whether slurry, cuttings, or process water could enter receiving waters. If inspections show that a violation of water quality standards could occur, stop operations and immediately implement preventive measures such as berms, barriers, secondary containment, and vacuum trucks.
- Inspect and verify that concrete washout BMPs are in place prior to the commencement of concrete work.
- During periods of concrete work, inspect daily to verify continued performance.
- Check overall condition and performance.
- Check remaining capacity (percent full).
- If using self-installed washout facilities, verify plastic liners are intact and sidewalls are not damaged.
- If using prefabricated containers, check for leaks.
- Do not discharge liquid or slurry to receiving waters, drainage channels, storm drains or directly onto ground.
- Do not use the public sanitary sewer without King County Industrial Waste Program approval.
- Place a secure, non-collapsing, non-water collecting cover over the concrete washout facility prior to a predicted wet weather event to prevent accumulation and overflow of precipitation.
- Remove and dispose of hardened concrete and return the structure to a functional condition. Concrete may be reused on site or hauled away for disposal or recycling.

- When removing materials from the self-installed concrete washout, build a new structure. If the previous structure is still intact, inspect for signs of weakening or damage, and make any necessary repairs. Re-line the structure with new plastic after each cleaning.

Removal of Temporary Concrete Washout Facilities

- When temporary concrete washout facilities are no longer required for the work, remove and properly dispose of the hardened concrete, slurries and liquids.
- Remove and dispose of or recycle materials used to construct temporary concrete washout facilities.
- Backfill, repair and stabilize holes, depressions or other ground disturbance caused by the removal of the temporary concrete washout facilities to prevent erosion.

~~5.1.11~~ 5.1.12. *BMP C1.59: High pH Neutralization Using CO₂*

Description

Methods for neutralization of high pH water prior to discharge into the drainage system or receiving waters.

Purpose

When pH levels in stormwater rise above 8.5 it is necessary to lower the pH levels to the acceptable range of 6.5 to 8.5, this process is called pH neutralization. pH neutralization involves the use of solid or compressed carbon dioxide gas in water requiring neutralization (CO₂ Sparging). Neutralized stormwater may be discharged to receiving waters under the Ecology Construction Stormwater General permit.

Neutralized process water such as concrete truck ~~washout~~ wash-out, hydro-demolition, or ~~sawcuttings~~ saw-cutting slurry must be managed to prevent discharge to receiving waters. Any stormwater contaminated during concrete work is considered process wastewater and must not be discharged to receiving waters.

Reasons for pH Neutralization

- A pH level range of 6.5 to 8.5 is typical for most natural watercourses, and this neutral pH is required for the survival of aquatic organisms. Should the pH rise or drop out of this range, fish and other aquatic organisms may become stressed and may die.
- Calcium hardness can contribute to high pH values and cause toxicity that is associated with high pH conditions. A high level of calcium hardness in receiving waters is not allowed.
- The water quality standard for pH in Washington State is in the range of 6.5 to 8.5. The groundwater standard for calcium and other dissolved solids in Washington State is less than 500 mg/l.

Conditions Where Practice Applies

Causes of High pH

High pH at project sites is most commonly caused by the contact of stormwater with poured or recycled concrete, cement, mortars, and other construction materials containing Portland cement or lime. (Refer to BMP C1.56 for more information on concrete handling procedures.) The principal caustic agent in cement is calcium hydroxide (free lime).

Advantages of CO₂ Sparging

- Rapidly neutralizes high pH water
- Cost effective and safer to handle than acid compounds
- CO₂ is self-buffering. It is difficult to overdose and create harmfully low pH levels
- Material is readily available

The Chemical Process

When carbon dioxide (CO₂) is added to water (H₂O), carbonic acid (H₂CO₃) is formed which can further dissociate into a proton (H⁺) and a bicarbonate anion (HCO₃⁻) as shown below:

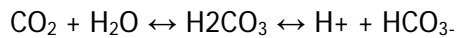

The free proton is a weak acid that can lower the pH. Water temperature has an effect on the reaction as well. The colder the water temperature is the slower the reaction occurs and the warmer the water temperature is the quicker the reaction occurs. Most construction applications in Washington State have water temperatures in the 50°F or higher range so the reaction is almost instantaneous.

Design Criteria

Treatment Process

High pH water may be treated using continuous treatment, continuous discharge systems. These manufactured systems continuously monitor influent and effluent pH to ensure that pH values are within an acceptable range before being discharged. All systems must have fail safe automatic shut off switches in the event that pH is not within the acceptable discharge range. Only trained operators may operate manufactured systems. System manufacturers often provide trained operators or training on their devices.

The following procedure may be used when not using a continuous discharge system:

1. Make every effort to isolate the potential high pH water in order to treat it separately from other stormwater on site.
2. Store water in an acceptable storage facility, detention pond, or containment cell prior to treatment.
3. Transfer water to be treated to the treatment structure. Ensure that treatment structure size is sufficient to hold the amount of water that is to be treated. Do not fill tank completely, allow at least 2 feet of freeboard.
4. Sample the water for pH and note the clarity of the water. Generally, less CO₂ is necessary for clearer water. Record this information in the stormwater treatment logbook.
5. In the pH adjustment structure, add CO₂ until the pH falls in the range of 6.9 to 7.1. Remember that pH water quality standards apply so adjusting pH to within 0.2 pH units of receiving water (background pH) is recommended. It is unlikely that pH can be adjusted to within 0.2 pH units using dry ice. Compressed carbon dioxide gas should be introduced to the water using a carbon dioxide diffuser located near the bottom of the tank, this will allow carbon dioxide to bubble up through the water and diffuse more evenly.
6. Slowly discharge the water making sure water does not get stirred up in the process. Release about 80 percent of the water from the structure leaving any sludge behind.
7. Discharge treated water through a pond or drainage system.
8. Excess sludge needs to be disposed of properly as concrete waste. If several batches of water are undergoing pH treatment, sludge can be left in the treatment structure for the next batch treatment. Dispose of sludge when it fills 50 percent of tank volume.

Sites that must implement flow control for the developed site must also control stormwater release rates during construction. All treated stormwater must go through a flow control facility before being released to receiving waters or systems which require flow control.

Maintenance Standards

Safety and Materials Handling

- Handle all equipment in accordance with Occupational Safety and Health Administration (OSHA) rules and regulations
- Follow manufacturer guidelines for materials handling

Operator Records

Each operator should provide:

- A diagram of the monitoring and treatment equipment
- A description of the pumping rates and capacity the treatment equipment is capable of treating

Each operator should keep a written record of the following:

- Client name and phone number
- Date of treatment
- Weather conditions
- Project name and location
- Volume of water treated
- pH of untreated water
- Amount of CO₂ needed to adjust water to a pH range of 6.9 to 7.1
- pH of treated water
- Discharge point location and description

A copy of this record should be given to the project proponent/owner/contractor who must retain the record for 3 years.

This page intentionally left blank.

**THIS COVER TO BE REPLACED
WITH SPU-PROVIDED COVER**
VOLUME 3 —
PROJECT STORMWATER CONTROL

CITY OF SEATTLE
SEATTLE PUBLIC UTILITIES
DEPARTMENT OF CONSTRUCTION AND INSPECTION

July 2021

Note:

Some pages in this document have been purposely skipped or blank pages inserted so that this document will copy correctly when duplexed.

Table of Contents

CHAPTER 1 - Introduction.....	1-1
1.1. Purpose of this Volume.....	1-1
1.2. How to Use this Volume.....	1-1
CHAPTER 2 - BMP Categories.....	2-1
2.1. Introduction.....	2-1
2.2. Soil Amendment.....	2-2
2.3. Tree Planting and Retention.....	2-2
2.4. Dispersion BMPs.....	2-2
2.5. Infiltration BMPs.....	2-3
2.6. Rainwater Harvesting BMPs.....	2-3
2.7. Alternative Surface BMPs.....	2-4
2.8. Detention BMPs.....	2-4
2.9. Non-infiltrating BMPs.....	2-5
CHAPTER 3 - BMP Selection and Sizing Approach.....	3-1
3.1. Determine Dispersion Feasibility.....	3-2
3.2. Determine Infiltration Feasibility.....	3-3
3.3. BMP Selection for On-site Stormwater Management.....	3-16
3.3.1. On-site List Approach.....	3-16
3.3.2. On-site Performance Standard.....	3-18
3.4. BMP Selection for Flow Control.....	3-19
3.5. BMP Selection for Water Quality Treatment.....	3-21
3.5.1. Selection Steps.....	3-21
3.5.2. Treatment Performance Goals and BMP Options.....	3-25
3.5.2.1. Oil Control Treatment.....	3-25
3.5.2.2. Phosphorus Treatment.....	3-26
3.5.2.3. Enhanced Treatment.....	3-26
3.5.2.4. Basic Treatment.....	3-28
CHAPTER 4 - General Design Requirements.....	4-1
4.1. Sizing Approach.....	4-2
4.1.1. On-site List Approach.....	4-2
4.1.2. Pre-sized Approach.....	4-3
4.1.2.1. Pre-sized Facilities.....	4-3
4.1.2.2. Pre-sized Credits, Sizing Factors, and Equations.....	4-3
4.1.2.3. Pre-sized Calculator.....	4-5
4.1.3. Modeling Approach.....	4-6
4.1.3.1. On-site Performance Standard.....	4-6
4.1.3.2. Flow Control.....	4-6
4.1.3.3. Water Quality Treatment.....	4-7
4.1.3.4. Wetland Hydroperiod Protection.....	4-8

- 4.1.3.5. Closed Depressions 4-8
- 4.2. Bypass, Flow-Through, and Off-Site Flow General Design Requirements 4-9
 - 4.2.1. Treatment BMPs 4-9
 - 4.2.2. Bypassing Flows Entering a Site 4-10
 - 4.2.2.1. Scenario 1 – Bypassing Flows Entering a Site 4-10
 - 4.2.2.2. Scenario 2 –Flow-Through a Flow Control BMP 4-10
 - 4.2.3. Bypassing Flows Leaving a Site 4-11
 - 4.2.3.1. Scenario 3 - Compensate for Uncontrolled Bypass 4-11
 - 4.2.3.2. Scenario 4 – Uncontrolled Flows Leaving the Site 4-12
- 4.3. Conveyance and Overflow General Design Requirements 4-13
 - 4.3.1. Conveyance Design and Capacity Analysis..... 4-13
 - 4.3.2. Requirements for Projects with No Off-site Point of Discharge 4-13
 - 4.3.3. BMP and Conveyance Overflow Requirements 4-16
- 4.4. Presettling and Pretreatment Requirements 4-17
 - 4.4.1. Description 4-17
 - 4.4.2. Performance Mechanisms 4-17
 - 4.4.3. Applicability 4-17
 - 4.4.3.1. Presettling and Pretreatment 4-17
 - 4.4.3.2. Pretreatment..... 4-20
 - 4.4.4. Site Considerations..... 4-21
 - 4.4.5. Design Criteria 4-21
 - 4.4.6. Operations and Maintenance Requirements 4-22
- 4.5. Infiltration BMPs 4-23
 - 4.5.1. Infiltration BMP Sizing 4-23
 - 4.5.2. Soil Requirements for Water Quality Treatment 4-24
 - 4.5.2.1. Underlying Soil Requirements for Infiltration BMPs 4-24
 - 4.5.2.2. Imported Soil and Sand 4-24
- CHAPTER 5 – BMP Design 5-1
 - 5.1. Soil Amendment BMP 5-2
 - 5.1.1. Description 5-2
 - 5.1.2. Performance Mechanisms 5-2
 - 5.1.3. Applicability 5-2
 - 5.1.4. Site Considerations..... 5-3
 - 5.1.5. Design Criteria 5-3
 - 5.1.5.1. Soil Amendments 5-3
 - 5.1.5.2. Implementation Options..... 5-4
 - 5.1.5.3. Soil Retention 5-6
 - 5.1.5.4. Soil Management Plan 5-6
 - 5.1.6. BMP Sizing 5-7
 - 5.1.7. Minimum Construction Requirements 5-7
 - 5.1.8. Operations and Maintenance Requirements 5-7
 - 5.2. Tree Planting and Retention 5-8
 - 5.2.1. Description 5-8
 - 5.2.2. Performance Mechanisms 5-8
 - 5.2.3. Applicability..... 5-8

5.2.4.	Site Considerations.....	5-8
5.2.4.1.	Retained Trees.....	5-8
5.2.4.2.	Newly Planted Trees.....	5-9
5.2.5.	Design Criteria.....	5-9
5.2.5.1.	Retained Trees.....	5-9
5.2.5.2.	Newly Planted Trees.....	5-10
5.2.6.	BMP Credits.....	5-12
5.2.6.1.	Credit for On-site List Approach.....	5-12
5.2.6.2.	Pre-Sized Approach for Flow Control.....	5-12
5.2.6.3.	Modeling Approach for On-site Performance Standard and Flow Control.....	5-12
5.2.7.	Minimum Construction Requirements.....	5-13
5.2.8.	Operations and Maintenance Requirements.....	5-13
5.3.	Dispersion BMPs.....	5-14
5.3.1.	Design Requirements for Dispersion BMPs.....	5-14
5.3.1.1.	General Site Considerations.....	5-14
5.3.1.2.	General Design Criteria for Dispersion Flowpaths.....	5-14
5.3.2.	Full Dispersion.....	5-16
5.3.3.	Splashblock Downspout Dispersion.....	5-17
5.3.3.1.	Description.....	5-17
5.3.3.2.	Performance Mechanisms.....	5-17
5.3.3.3.	Applicability.....	5-17
5.3.3.4.	Site Considerations.....	5-17
5.3.3.5.	Design Criteria.....	5-17
5.3.3.6.	BMP Credits.....	5-20
5.3.3.7.	Minimum Construction Requirements.....	5-21
5.3.3.8.	Operations and Maintenance Requirements.....	5-22
5.3.4.	Trench Downspout Dispersion.....	5-23
5.3.4.1.	Description.....	5-23
5.3.4.2.	Performance Mechanisms.....	5-23
5.3.4.3.	Applicability.....	5-23
5.3.4.4.	Site Considerations.....	5-23
5.3.4.5.	Design Criteria.....	5-23
5.3.4.6.	BMP Credits.....	5-26
5.3.4.7.	Minimum Construction Requirements.....	5-27
5.3.4.8.	Operations and Maintenance Requirements.....	5-27
5.3.5.	Sheet Flow Dispersion.....	5-28
5.3.5.1.	Description.....	5-28
5.3.5.2.	Performance Mechanisms.....	5-28
5.3.5.3.	Applicability.....	5-28
5.3.5.4.	Site Considerations.....	5-28
5.3.5.5.	Design Criteria.....	5-28
5.3.5.6.	BMP Credits.....	5-30
5.3.5.7.	Minimum Construction Requirements.....	5-31
5.3.5.8.	Operations and Maintenance Requirements.....	5-31
5.3.6.	Concentrated Flow Dispersion.....	5-32

5.3.6.1.	Description	5-32
5.3.6.2.	Performance Mechanisms	5-32
5.3.6.3.	Applicability	5-32
5.3.6.4.	Site Considerations.....	5-32
5.3.6.5.	Design Criteria	5-32
5.3.6.6.	BMP Credits.....	5-35
5.3.6.7.	Minimum Construction Requirements	5-36
5.3.6.8.	Operations and Maintenance Requirements.....	5-37
5.3.7.	Sidewalk/Trail Compost-Amended Strip.....	5-38
5.3.7.1.	Description	5-38
5.3.7.2.	Performance Mechanisms	5-38
5.3.7.3.	Applicability	5-38
5.3.7.4.	Site Considerations.....	5-38
5.3.7.5.	Design Criteria	5-39
5.3.7.6.	BMP Sizing	5-41
5.3.7.7.	Minimum Construction Requirements	5-43
5.3.7.8.	Operation and Maintenance Requirements.....	5-43
5.4.	Infiltration BMPs.....	5-44
5.4.1.	General Considerations for Infiltration BMPs	5-45
5.4.2.	Infiltration Trenches	5-47
5.4.2.1.	Description	5-47
5.4.2.2.	Performance Mechanisms	5-47
5.4.2.3.	Applicability	5-47
5.4.2.4.	Site Considerations.....	5-48
5.4.2.5.	Design Criteria	5-48
5.4.2.6.	BMP Credits.....	5-51
5.4.2.7.	Minimum Construction Requirements	5-54
5.4.2.8.	Operations and Maintenance Requirements.....	5-54
5.4.3.	Drywells.....	5-55
5.4.3.1.	Description	5-55
5.4.3.2.	Performance Mechanisms	5-55
5.4.3.3.	Applicability	5-55
5.4.3.4.	Site Considerations.....	5-55
5.4.3.5.	Design Criteria	5-55
5.4.3.6.	BMP Sizing	5-59
5.4.3.7.	Minimum Construction Requirements	5-61
5.4.3.8.	Operations and Maintenance Requirements.....	5-61
5.4.4.	Infiltrating Bioretention.....	5-62
5.4.4.1.	Description	5-62
5.4.4.2.	Performance Mechanisms	5-62
5.4.4.3.	Applicability	5-63
5.4.4.4.	Site Considerations.....	5-63
5.4.4.5.	Design Criteria	5-63
5.4.4.6.	BMP Sizing	5-81
5.4.4.7.	Minimum Construction Requirements	5-88
5.4.4.8.	Operations and Maintenance Requirements.....	5-88

5.4.5.	Rain Gardens	5-89
5.4.5.1.	Description	5-89
5.4.5.2.	Performance Mechanisms	5-89
5.4.5.3.	Applicability	5-89
5.4.5.4.	Site Considerations	5-90
5.4.5.5.	Design Criteria	5-90
5.4.5.6.	BMP Sizing	5-96
5.4.5.7.	Minimum Construction Requirements	5-97
5.4.5.8.	Operations and Maintenance Requirements	5-97
5.4.6.	Permeable Pavement Facilities	5-98
5.4.6.1.	Description	5-98
5.4.6.2.	Performance Mechanisms	5-99
5.4.6.3.	Applicability	5-99
5.4.6.4.	Site Considerations	5-99
5.4.6.5.	Design Criteria	5-100
5.4.6.6.	BMP Sizing	5-113
5.4.6.7.	Minimum Construction Requirements	5-117
5.4.6.8.	Operations and Maintenance Requirements	5-118
5.4.7.	Perforated Stub-Out Connections	5-119
5.4.7.1.	Description	5-119
5.4.7.2.	Performance Mechanisms	5-119
5.4.7.3.	Applicability	5-119
5.4.7.4.	Site Considerations	5-119
5.4.7.5.	Design Criteria	5-119
5.4.7.6.	BMP Credits	5-122
5.4.7.7.	Minimum Construction Requirements	5-122
5.4.7.8.	Operations and Maintenance Requirements	5-122
5.4.8.	Infiltration Basins	5-123
5.4.8.1.	Description	5-123
5.4.8.2.	Performance Mechanisms	5-123
5.4.8.3.	Applicability	5-123
5.4.8.4.	Site Considerations	5-123
5.4.8.5.	Design Criteria	5-123
5.4.8.6.	BMP Sizing	5-123
5.4.8.7.	Minimum Construction Requirements	5-123
5.4.8.8.	Operations and Maintenance Requirements	5-124
5.4.9.	Infiltration Chambers/Vaults	5-125
5.4.9.1.	Description	5-125
5.4.9.2.	Performance Mechanisms	5-125
5.4.9.3.	Applicability	5-125
5.4.9.4.	Site Considerations	5-125
5.4.9.5.	Design Criteria	5-126
5.4.9.6.	BMP Sizing	5-128
5.4.9.7.	Minimum Construction Requirements	5-130
5.4.9.8.	Operations and Maintenance Requirements	5-131
5.5.	Rainwater Harvesting BMPs	5-132

5.5.1.	Rainwater Harvesting	5-133
5.5.1.1.	Description	5-133
5.5.1.2.	Performance Mechanisms	5-133
5.5.1.3.	Applicability	5-133
5.5.1.4.	Site Considerations.....	5-133
5.5.1.5.	Design Criteria	5-134
5.5.1.6.	BMP Sizing	5-136
5.5.1.7.	Minimum Construction Requirements	5-140
5.5.1.8.	Operations and Maintenance Requirements.....	5-141
5.5.2.	Single-Family Residential (SFR) Cisterns.....	5-142
5.5.2.1.	Description	5-142
5.5.2.2.	Performance Mechanisms	5-142
5.5.2.3.	Applicability	5-142
5.5.2.4.	Site Considerations.....	5-142
5.5.2.5.	Design Criteria	5-142
5.5.2.6.	BMP Sizing	5-145
5.5.2.7.	Minimum Construction Requirements	5-145
5.5.2.8.	Operations and Maintenance Requirements.....	5-145
5.6.	Alternative Surface BMPs	5-146
5.6.1.	Vegetated Roof Systems.....	5-147
5.6.1.1.	Description	5-147
5.6.1.2.	Performance Mechanisms	5-148
5.6.1.3.	Applicability	5-148
5.6.1.4.	Site Considerations.....	5-148
5.6.1.5.	Design Criteria	5-148
5.6.1.6.	BMP Credits.....	5-151
5.6.1.7.	Minimum Construction Requirements	5-152
5.6.1.8.	Operations and Maintenance Requirements.....	5-152
5.6.2.	Permeable Pavement Surfaces	5-153
5.6.2.1.	Description	5-153
5.6.2.2.	Performance Mechanisms	5-153
5.6.2.3.	Applicability	5-153
5.6.2.4.	Site Considerations.....	5-153
5.6.2.5.	Design Criteria	5-154
5.6.2.6.	BMP Sizing	5-158
5.6.2.7.	Minimum Construction Requirements	5-161
5.6.2.8.	Operations and Maintenance Requirements.....	5-161
5.7.	Detention BMPs	5-162
5.7.1.	Detention Ponds	5-163
5.7.1.1.	Description	5-163
5.7.1.2.	Performance Mechanisms	5-163
5.7.1.3.	Applicability	5-163
5.7.1.4.	Site Considerations.....	5-163
5.7.1.5.	Design Criteria	5-164
5.7.1.6.	BMP Sizing	5-166
5.7.1.7.	Minimum Construction Requirements	5-166

5.7.1.8.	Operations and Maintenance Requirements.....	5-166
5.7.2.	Detention Pipes.....	5-167
5.7.2.1.	Description.....	5-167
5.7.2.2.	Performance Mechanisms.....	5-167
5.7.2.3.	Applicability.....	5-167
5.7.2.4.	Site Considerations.....	5-167
5.7.2.5.	Design Criteria.....	5-168
5.7.2.6.	BMP Sizing.....	5-171
5.7.2.7.	Minimum Construction Requirements.....	5-173
5.7.2.8.	Operations and Maintenance Requirements.....	5-173
5.7.3.	Detention Vaults/Chambers.....	5-175
5.7.3.1.	Description.....	5-175
5.7.3.2.	Performance Mechanisms.....	5-175
5.7.3.3.	Applicability.....	5-175
5.7.3.4.	Site Considerations.....	5-175
5.7.3.5.	Design Criteria.....	5-176
5.7.3.6.	BMP Sizing.....	5-180
5.7.3.7.	Minimum Construction Requirements.....	5-182
5.7.3.8.	Operations and Maintenance Requirements.....	5-183
5.7.4.	Detention Cisterns.....	5-184
5.7.4.1.	Description.....	5-184
5.7.4.2.	Performance Mechanisms.....	5-184
5.7.4.3.	Applicability.....	5-184
5.7.4.4.	Site Considerations.....	5-184
5.7.4.5.	Design Criteria.....	5-184
5.7.4.6.	BMP Sizing.....	5-186
5.7.4.7.	Minimum Construction Requirements.....	5-188
5.7.4.8.	Operations and Maintenance Requirements.....	5-188
5.7.5.	Other Detention Options.....	5-189
5.7.5.1.	Use of Parking Lots for Additional Detention.....	5-189
5.7.5.2.	Use of Roofs for Detention.....	5-189
5.8.	Non-Infiltrating BMPs.....	5-190
5.8.1.	Design Requirements for Non-infiltrating BMPs.....	5-190
5.8.1.1.	Site and Design Considerations.....	5-190
5.8.2.	Non-Infiltrating Bioretention.....	5-192
5.8.2.1.	Description.....	5-192
5.8.2.2.	Performance Mechanisms.....	5-192
5.8.2.3.	Applicability.....	5-193
5.8.2.4.	Site Considerations.....	5-193
5.8.2.5.	Design Criteria.....	5-194
5.8.2.6.	BMP Sizing.....	5-196
5.8.2.7.	Minimum Construction Requirements.....	5-199
5.8.2.8.	Operations and Maintenance Requirements.....	5-199
5.8.3.	Biofiltration Swales.....	5-200
5.8.3.1.	Description.....	5-200
5.8.3.2.	Performance Mechanisms.....	5-200

5.8.3.3.	Applicability	5-200
5.8.3.4.	Site Considerations	5-201
5.8.3.5.	Design Criteria	5-202
5.8.3.6.	BMP Sizing	5-206
5.8.3.7.	Minimum Construction Requirements	5-206
5.8.3.8.	Operations and Maintenance Requirements	5-207
5.8.4.	Filter Strips/Drains	5-208
5.8.4.1.	Description	5-208
5.8.4.2.	Performance Mechanisms	5-208
5.8.4.3.	Applicability	5-208
5.8.4.4.	Site Considerations	5-209
5.8.4.5.	Design Criteria	5-209
5.8.4.6.	BMP Sizing	5-210
5.8.4.7.	Minimum Construction Requirements	5-210
5.8.4.8.	Operations and Maintenance Requirements	5-211
5.8.5.	Sand Filters	5-212
5.8.5.1.	Description	5-212
5.8.5.2.	Performance Mechanisms	5-212
5.8.5.3.	Applicability	5-213
5.8.5.4.	Site Considerations	5-213
5.8.5.5.	Design Criteria	5-214
5.8.5.6.	BMP Sizing	5-217
5.8.5.7.	Minimum Construction Requirements	5-221
5.8.5.8.	Operations and Maintenance Requirements	5-221
5.8.6.	Wet Ponds	5-222
5.8.6.1.	Description	5-222
5.8.6.2.	Performance Mechanisms	5-222
5.8.6.3.	Applicability	5-222
5.8.6.4.	Site Considerations	5-222
5.8.6.5.	Design Criteria	5-223
5.8.6.6.	BMP Sizing	5-226
5.8.6.7.	Minimum Construction Requirements	5-226
5.8.6.8.	Operations and Maintenance Requirements	5-226
5.8.7.	Wet Vaults	5-227
5.8.7.1.	Description	5-227
5.8.7.2.	Performance Mechanisms	5-227
5.8.7.3.	Applicability	5-227
5.8.7.4.	Site Considerations	5-227
5.8.7.5.	Design Criteria	5-228
5.8.7.6.	BMP Sizing	5-233
5.8.7.7.	Minimum Construction Requirements	5-233
5.8.7.8.	Operations and Maintenance Requirements	5-233
5.8.8.	Stormwater Treatment Wetlands	5-234
5.8.8.1.	Description	5-234
5.8.8.2.	Performance Mechanisms	5-234
5.8.8.3.	Applicability	5-234

5.8.8.4.	Site Considerations	5-234
5.8.8.5.	Design Criteria	5-234
5.8.8.6.	BMP Sizing	5-235
5.8.8.7.	Minimum Construction Requirements	5-235
5.8.8.8.	Operations and Maintenance Requirements.....	5-235
5.8.9.	Combined Detention and Wet Pool Facilities	5-236
5.8.9.1.	Description	5-236
5.8.9.2.	Performance Mechanisms	5-236
5.8.9.3.	Applicability	5-237
5.8.9.4.	Site Considerations.....	5-237
5.8.9.5.	Design Criteria	5-237
5.8.9.6.	BMP Sizing	5-237
5.8.9.7.	Minimum Construction Requirements	5-238
5.8.9.8.	Operations and Maintenance Requirements.....	5-238
5.8.10.	Oil/Water Separators	5-239
5.8.10.1.	Description	5-239
5.8.10.2.	Performance Mechanisms	5-239
5.8.10.3.	Applicability	5-239
5.8.10.4.	Site Considerations.....	5-240
5.8.10.5.	Design Criteria	5-241
5.8.10.6.	BMP Sizing	5-246
5.8.10.7.	Minimum Construction Requirements	5-248
5.8.10.8.	Operations and Maintenance Requirements.....	5-248
5.8.11.	Proprietary and Emerging Water Quality Treatment Technologies	5-249
5.8.11.1.	Description	5-249
5.8.11.2.	Performance Mechanisms	5-250
5.8.11.3.	Applicability and Restrictions	5-250
5.8.11.4.	Site Considerations.....	5-251
5.8.11.5.	Design Criteria	5-251
5.8.11.6.	BMP Sizing	5-252
5.8.11.7.	Minimum Construction Requirements	5-254
5.8.11.8.	Operations and Maintenance Requirements.....	5-254
CHAPTER 6 -	References	6-1

Tables

Table 3.1.	Minimum Investigation and Testing Requirements for Shallow Infiltration BMPs.	3-10
Table 3.2.	Minimum Investigation and Testing Requirements for Deep Infiltration BMPs.	3-12
Table 3.3.	Minimum Measured Infiltration Rates.....	3-13
Table 3.4.	Flow Control BMPs and Applicable Standards.	3-20
Table 3.5.	Zoning Categorization and TSS Characteristics.	3-21
Table 3.6.	Treatment Trains for Phosphorus Treatment.	3-26
Table 3.7.	Treatment Trains for Enhanced Treatment.	3-27
Table 4.1.	Presettling and Pretreatment Requirements.	4-18
Table 5.1.	Minimum Soil Volume for Trees in Planters.....	5-10
Table 5.2.	Pre-sized On-site Stormwater Management and Flow Control Credits for Retained Trees.	5-12
Table 5.3.	Pre-sized On-site Stormwater Management and Flow Control Credits for Newly Planted Trees.	5-12
Table 5.4.	Pre-Sized Flow Control Credits for Splashblock Downspout Dispersion.	5-21
Table 5.5.	Continuous Modeling Assumptions for Downspout Dispersion.....	5-21
Table 5.6.	Pre-sized Flow Control Credits for Trench Downspout Dispersion.	5-26
Table 5.7.	Continuous Modeling Assumptions for Trench Downspout Dispersion.	5-27
Table 5.8.	Pre-sized Flow Control Credits for Sheet Flow Dispersion.	5-30
Table 5.9.	Continuous Modeling Assumptions for Sheet Flow Dispersion.....	5-31
Table 5.10.	Pre-sized Flow Control Credits for Concentrated Flow Dispersion.....	5-36
Table 5.11.	Continuous Modeling Assumptions for Concentrated Flow Dispersion.	5-36
Table 5.12.	On-site List Sizing for Sidewalk/Trail Compost-Amended Strips.	5-42
Table 5.13.	Continuous Modeling Assumptions for Sidewalk/Trail Compost-Amended Strips.	5-42
Table 5.14.	On-site List Sizing for Infiltration Trenches.	5-51
Table 5.15.	Pre-Sized Sizing Factors and Equations for Infiltration Trenches.	5-53
Table 5.16.	Continuous Modeling Assumptions for Infiltration Trench Facilities.	5-54
Table 5.17.	On-site List Sizing for Drywells.	5-59
Table 5.18.	Pre-Sized Sizing Factors and Equations for Drywells.	5-60
Table 5.19.	Presettling Requirements for Bioretention Facilities in Roadway Projects.....	5-70

Table 5.20.	Presettling Requirements for Bioretention Facilities in Non-roadway Projects.	5-71
Table 5.21.	On-site List Sizing for Infiltrating Bioretention with and without Underdrains.	5-81
Table 5.22.	Pre-sized Sizing Factors and Equations for Infiltrating Bioretention Without Underdrains.	5-84
Table 5.23.	Pre-sized Sizing Factors and Equations for Infiltrating Bioretention with Underdrains.	5-86
Table 5.24.	Continuous Modeling Assumptions for Infiltrating Bioretention.	5-87
Table 5.25.	On-site List Sizing for Rain Gardens.	5-96
Table 5.26.	Pre-sized Sizing Factors and Equations for Permeable Pavement Facilities without Underdrains.	5-115
Table 5.27.	Continuous Modeling Assumptions for Permeable Pavement Facility.	5-117
Table 5.28.	Pre-Sized Sizing Factors and Equations for Infiltration Chambers.	5-129
Table 5.29.	Continuous Modeling Assumptions for Infiltration Chambers/Vaults.	5-130
Table 5.30.	Typical Assumptions for Non-Potable Rainwater Demand Calculations.	5-137
Table 5.31.	Typical Assumptions for Potable Rainwater Demand Calculations.	5-139
Table 5.32.	Continuous Modeling Assumptions for Rainwater Harvesting.	5-140
Table 5.33.	On-site List Sizing for SFR Cisterns.	5-145
Table 5.34.	Pre-sized Flow Control Credits for Vegetated Roofs.	5-151
Table 5.35.	Continuous Modeling Assumptions for Vegetated Roof Systems.	5-152
Table 5.36.	Pre-Sized Flow Control Credits for Permeable Pavement Surfaces with and without Check Dams.	5-158
Table 5.37.	Modeling Methods for Permeable Pavement Surfaces.	5-159
Table 5.38.	Continuous Modeling Assumptions for Permeable Pavement Surface.	5-160
Table 5.39.	Pre-sized Sizing Equations for Detention Pipe.	5-172
Table 5.40.	Continuous Modeling Assumptions for Detention Pipe.	5-173
Table 5.41.	Pre-sized Sizing Equations for Detention Vaults.	5-181
Table 5.42.	Continuous Modeling Assumptions for Detention Vaults/Chambers.	5-182
Table 5.43.	Pre-Sized Sizing Factors and Equations for Aboveground Detention Cisterns.	5-187
Table 5.44.	Non-infiltrating BMP Placement in Relation to Detention BMP.	5-191
Table 5.45.	On-site List Sizing for Non-infiltrating Bioretention.	5-197
Table 5.46.	Pre-Sized Sizing Factors and Equations for Non-Infiltrating Bioretention. ...	5-198

Table 5.47.	Basic and Compost Amended Vegetated Filter Strip Design and Sizing Criteria.	5-210
Table 5.48.	Sand Filter Design Parameters.	5-219
Table 5.49.	Sand Filter Area Increments for Various Soil and Cover Types.	5-220
Table 5.50.	Sand Filter Design and Sizing Criteria.	5-221

Figures

Figure 3.1.	Infiltration Feasibility.	3-5
Figure 3.2.	Water Quality Treatment BMP Selection Flow Chart.	3-24
Figure 5.1.	Cross-Section of Soil Amendment.	5-5
Figure 5.2.	Typical Downspout Splashblock Dispersion.	5-18
Figure 5.3.	Typical Downspout Splashblock.	5-19
Figure 5.4.	Typical Downspout Dispersion Trench.	5-24
Figure 5.5.	Typical Sheet Flow Dispersion for Flat and Moderately Sloping Driveways.	5-29
Figure 5.6.	Typical Concentrated Flow Dispersion for Steep Driveways.	5-33
Figure 5.7.	Typical Sidewalk/Trail Compost-Amended Strip BMP.	5-40
Figure 5.8.	Typical Infiltration Trench Receiving Concentrated Flow.	5-50
Figure 5.9.	Typical Infiltration Trench Receiving Sheet Flow.	5-51
Figure 5.10.	Typical Infiltration Drywell.	5-57
Figure 5.11.	Infiltrating Bioretention Facility with Sloped Sides (without Underdrain).	5-64
Figure 5.12.	Infiltrating Bioretention Facility with Vertical Sides (without Underdrain).	5-65
Figure 5.13.	Infiltrating Bioretention Facility with Sloped Sides (with Underdrain).	5-66
Figure 5.14.	Infiltrating Bioretention Facility with Vertical Sides (with Underdrain).	5-67
Figure 5.15.	Stormwater Facility Cleanout for Facility Outside of the Right-of-Way.	5-77
Figure 5.16.	Typical Rain Garden.	5-91
Figure 5.17.	Permeable Pavement Facility.	5-102
Figure 5.18.	Example Permeable Pavement Facility with Checkdams.	5-103
Figure 5.19.	Example Permeable Pavement Concrete Edge Treatment.	5-112
Figure 5.20.	Example Permeable Pavement Geomembrane Edge Treatment.	5-113
Figure 5.21.	Perforated Stub-Out Connection.	5-120
Figure 5.22.	Typical Infiltration Chamber/Vault.	5-127

Figure 5.23. Detention Cistern with Harvesting Capacity for Single-Family Residential Projects Only. 5-143

Figure 5.24. Vegetated Roof System. 5-147

Figure 5.25. Permeable Pavement Surface..... 5-155

Figure 5.26. Typical Private Property Detention Pipe..... 5-169

Figure 5.27. Typical Detention Vault..... 5-177

Figure 5.28. Detention Cistern. 5-185

Figure 5.29. Non-infiltrating Bioretention Facility with Sloped Sides..... 5-194

Figure 5.30. Non-infiltrating Bioretention Facility with Vertical Sides. 5-195

Figure 5.31. Biofiltration Swale Plan and Profile..... 5-203

Figure 5.32. Typical Wet Vault. 5-230

Figure 5.33. Typical API (Baffle Type) Separator. 5-242

Figure 5.34. Typical Coalescing Plate Separator. 5-243

CHAPTER 1 – INTRODUCTION

1.1. Purpose of this Volume

Volume 3 (*Project Stormwater Control*) of the City of Seattle Stormwater Manual presents approved methods, requirements, criteria, details, and general guidance for analysis and design of on-site stormwater management, flow control, and water quality treatment pursuant to the Seattle Municipal Code (SMC), Chapter 22.800 through 22.808, the Stormwater Code.

This volume describes and provides technical requirements for selecting, designing, constructing, and maintaining best management practices (BMPs) required by the Stormwater Code. These BMPs are designed to reduce the flow rates or volumes of stormwater runoff, reduce the level of pollutants contained in that runoff, and convey stormwater runoff. In accordance with provisions of the Stormwater Code, additional BMPs beyond those specified in this volume may be required.

1.2. How to Use this Volume

- *Chapter 1* (this chapter) outlines the purpose and content of this volume.
- *Chapter 2* describes the BMP categories.
- *Chapter 3* describes the steps required to select appropriate BMPs after the minimum requirements for on-site stormwater management, flow control, and/or water quality treatment have been determined using *Volume 1*.
- *Chapter 4* provides general design requirements for the following:
 - On-site List Approach, Pre-sized Approach, and Modeling Approach
 - Information pertinent to bypass and conveyance design
 - Presettling and pretreatment requirements
 - Infiltration BMP sizing requirements
- *Chapter 5* provides detailed descriptions and design criteria for BMPs outlined in *Chapter 2*.
- Several appendices also support the information contained in this volume. These appendices include:
 - *Appendix A* – Definitions
 - *Appendix C* – On-site Stormwater Management BMP Infeasibility Criteria
 - *Appendix D* – Subsurface Investigation and Infiltration Testing for Infiltration BMPs
 - *Appendix E* – Additional Design Requirements and Plant Lists
 - *Appendix F* – Hydrologic Analysis and Design

- *Appendix G* – Stormwater Control Operations and Maintenance Requirements
- *Appendix H* – Financial Feasibility Documentation for Vegetated Roofs and Rainwater Harvesting

CHAPTER 2 – BMP CATEGORIES

2.1. Introduction

BMPs are designed to reduce the flow rates or volumes of stormwater runoff, reduce the level of pollutants contained in that runoff, and convey stormwater runoff. BMPs include structural stormwater facilities that provide long-term management of stormwater at developed sites. This volume covers four primary functional categories of stormwater BMPs:

- **On-site stormwater management** includes BMPs designed to reduce runoff volume and pollutants from development using infiltration, dispersion, and retention of stormwater runoff on-site.
- **Flow control BMPs** typically detain, retain, or infiltrate stormwater runoff to control the flow rate, frequency, duration, and sometimes the volume of stormwater runoff leaving the site.
- **Water quality treatment BMPs** remove pollutants through one or more of the following processes: gravity settling of particulate pollutants, filtration, biological processes, and/or adsorption. Target pollutants include:
 - Sand, silt, and other suspended solids
 - Metals such as copper, lead, and zinc
 - Nutrients (e.g., nitrogen and phosphorus)
 - Certain bacteria and viruses
 - Organic contaminants such as petroleum hydrocarbons and pesticides

Water quality treatment in this volume is divided into the following four categories based on the type of pollutant removal provided: basic treatment, enhanced treatment, oil treatment, or phosphorus treatment. Additional details on these treatment categories are provided in *Section 3.5*.

- **Conveyance BMPs** are designed to transport stormwater and can incorporate additional functions such as flow control or water quality treatment.

Note that some BMPs fall under more than one functional category. Determining which BMPs to use for a given application will depend on the applicable Stormwater Code requirements (refer to *Volume 1*), as well as site-specific factors such as available land surface and infiltration capacity of the soils. Distributed BMPs using infiltration, filtration, storage, evapotranspiration, or stormwater reuse are preferred when feasible. Additional requirements for conveyance are described in the Side Sewer Code (SMC, Chapter 21.16) and associated rules.

To help further differentiate among the many functions, applications, and design requirements presented in this volume the following sections describe eight subcategories of BMPs. BMPs are placed in one of the following subcategories based on their primary function:

1. Soil amendment BMP
2. Tree planting and retention
3. Dispersion BMPs
4. Infiltration BMPs
5. Rainwater harvesting BMPs
6. Alternative surface BMPs
7. Detention BMPs
8. Non-infiltrating BMPs

Each section contains a chart identifying the functional categories to which the BMP can be applied (to meet a requirement) and a reference to the section within this volume containing additional information.

2.2. Soil Amendment

Site soils shall meet the minimum quality and depth requirement at project completion (*Section 5.1*). Requirements may be achieved by either retaining and protecting undisturbed soil or restoring the soil (e.g., amending with compost) in disturbed areas.

2.3. Tree Planting and Retention

Tree planting and retention provides interception and evapotranspiration of stormwater.

BMP	On-site	Flow Control	Water Quality	Conveyance	Reference
Tree planting and retention	✓ ^a	✓ ^a			<i>Section 5.2</i>

^a [On-site](#) Performance and Flow Control Standards may be partially achieved.

2.4. Dispersion BMPs

Dispersion is a simple method of stormwater management that uses surface grading to avoid concentrating flows or to disperse flows over vegetation.

The dispersion BMPs described in this volume include:

BMP	On-site	Flow Control	Water Quality	Conveyance	Reference
Full dispersion	✓ ^a	✓ ^a			<i>Section 5.3.2</i>
Splashblock downspout dispersion	✓ ^a	✓ ^a	✓ ^b		<i>Section 5.3.3</i>
Trench downspout dispersion	✓ ^a	✓ ^a	✓ ^b		<i>Section 5.3.4</i>
Sheet flow dispersion	✓ ^a	✓ ^a	✓ ^b		<i>Section 5.3.5</i>
Concentrated flow dispersion	✓ ^a	✓ ^a	✓ ^b		<i>Section 5.3.6</i>
Sidewalk/trail compost-amended strip	✓ ^a				Section 5.3.7

^a [On-site](#) Performance and Flow Control Standards may be partially or completely achieved depending upon underlying soil type.

^b Meets Basic Treatment when additional design requirements for [vegetated](#) filter strips are met (refer to *Section 5.8.4*).

2.5. Infiltration BMPs

Infiltration BMPs are designed to facilitate infiltration of stormwater into the ground. Infiltration is feasible only where sufficiently porous soils are available and where other site constraints are not limiting (e.g., steep slopes, high groundwater), as detailed under *Section 3.2*.

The infiltration BMPs described in this volume include:

BMP	On-site	Flow Control	Water Quality	Conveyance	Reference
Infiltration trenches ^a	✓	✓	✓ ^{b, c}		<i>Section 5.4.2</i>
Drywells ^a	✓	✓			<i>Section 5.4.3</i>
Infiltrating bioretention	✓ ^d	✓ ^d	✓ ^c	✓ ^e	<i>Section 5.4.4</i>
Rain gardens	✓ ^f			✓ ^e	<i>Section 5.4.5</i>
Permeable pavement facilities	✓	✓	✓ ^{c, g}		<i>Section 5.4.6</i>
Perforated stub-out connections	✓ ^f				<i>Section 5.4.7</i>
Infiltration basins	✓ ^h	✓	✓ ^b		<i>Section 5.4.8</i>
Infiltration chambers/vaults	✓ ^h	✓	✓ ^b		<i>Section 5.4.9</i>

^a Only applicable where the site measured infiltration rate is at least 5 inches per hour. PGHS or PGPS may only be directed to infiltration trenches and drywells if the soil suitability criteria for the subgrade soils is met (*Section 4.5.2*).

^b Soil suitability criteria for subgrade soils (refer to *Section 4.5.2*) and applicable drawdown requirements (*Section 4.5.1*) also apply.

^c Refer to Phosphorus treatment train options for infiltration BMPs included in *Section 4.4.3.2*.

^d For infiltrating bioretention with underdrain, [On-site LID](#) Performance and Flow Control standards may be partially or fully achieved depending upon ponding depth, degree of underdrain elevation, infiltration rate, contributing area, and use of orifice control.

^e Infiltrating bioretention and rain gardens may be connected in series, with the overflows of upstream cells directed to downstream cells to provide conveyance.

^f Included in the On-site List, but cannot be used to meet the On-site Performance Standard.

^g Underlying soil shall meet the treatment soil requirements outlined in *Section 4.5.2* or a water quality treatment course shall be included per *Section 5.4.6.5*.

^h Not included in the On-site List, but can be used to meet the On-site Performance Standard.

2.6. Rainwater Harvesting BMPs

Rainwater harvesting BMPs capture and store rainwater for beneficial use. Roof runoff may be routed to cisterns for storage and non-potable uses such as irrigation, toilet flushing, mechanical equipment, and cold water supply to laundry with basic filtration. Additional filtration and disinfection is required for use of collected roof runoff for potable use. Using collected roof runoff for potable use is only allowed for single-family residential (SFR) projects. Design plans for use of harvested rainwater shall be prepared per *Rainwater Harvesting and Connection to Plumbing Fixtures* (Public Health – Seattle & King County 2011).

The rainwater harvesting BMPs described in this volume include:

BMP	On-site	Flow Control	Water Quality	Conveyance	Reference
Rainwater harvesting ^a	✓	✓			Section 5.5.1
Single-family Residential (SFR) cisterns	✓				Section 5.5.2

^a Rainwater harvesting is not approved for pollution-generating surfaces, so the water quality [treatment](#) standard is not applicable.

2.7. Alternative Surface BMPs

Alternative surface BMPs convert a conventional impervious surface to a surface that reduces the amount of stormwater runoff and also provides flow control.

The alternative surface BMPs described in this volume include:

BMP	On-site	Flow Control	Water Quality	Conveyance	Reference
Vegetated roof systems	✓ ^a	✓ ^a			Section 5.6.1
Permeable pavement surfaces ^b	✓	✓ ^{c, d}	✓ ^{c, d, e}		Section 5.6.2

^a On-site Performance and Flow Control Standard may be partially achieved.

^b While similar to permeable pavement “facilities” (refer to [Section 2.5](#)), permeable pavement “surfaces” are designed to function as a permeable land surface and not intended to receive runoff from other surfaces. Therefore, they are not considered infiltration facilities and have less onerous siting and design requirements.

^c Infiltration testing is required to meet flow control and water quality treatment standards (refer to [Appendix D](#)).

^d Standard may be partially or completely achieved depending upon subgrade slope, infiltration rate of subgrade soil, and whether aggregate subbase is laid above or below surrounding grade.

^e Underlying soil shall meet the treatment soil requirements outlined in [Section 4.5.2](#) or a water quality treatment course shall be included per [Section 5.4.6.54.5.6.5](#).

2.8. Detention BMPs

Detention BMPs are designed to collect and temporarily store runoff and then release it over a period of time at a reduced rate. Detention BMPs have an outlet control structure designed to release flows at an attenuated rate to meet flow control standards. Detention BMPs can also be combined with non-infiltrating BMPs to provide [water quality runoff](#) treatment as well as flow control benefits. For a summary of combined detention and wet pool BMPs refer to [Section 2.9](#).

The detention BMPs described in this volume include:

BMP	On-site	Flow Control	Water Quality	Conveyance	Reference
Detention ponds	✓ ^a	✓		✓	Section 5.7.1
Detention pipes	✓ ^a	✓ ^b		✓	Section 5.7.2
Detention vaults/ chambers	✓ ^a	✓ ^b		✓	Section 5.7.3
Detention cisterns	✓	✓ ^b		✓	Section 5.7.4
Other detention options		✓		✓	Section 5.7.5

^a Not included in the On-site List, but can be used to partially achieve the On-site Performance Standard for smaller contributing areas.

^b Standard may be partially or completely achieved depending upon contributing area and minimum orifice size.

2.9. Non-infiltrating BMPs

Non-infiltrating BMPs are designed to remove pollutants contained in stormwater runoff. Some non-infiltrating BMPs may provide low levels of flow control as a secondary benefit, or be combined with detention BMPs to meet flow control requirements.

Subcategories of non-infiltrating BMPs are presented below:

- Non-infiltrating Bioretention** is similar to infiltrating bioretention (*Section 5.4.4*) except that facilities are designed with an [low-permeability or impervious bottom and sidewalls preventing infiltration to underlying soil](#). [Non-infiltrating bioretention can also be used without a liner if existing site soil infiltration rate is less than required for an infiltrating BMP and certain criteria described in Section 5.8.2 are met](#). After infiltrating through the bioretention soil, the water is discharged via an underdrain. Non-infiltrating bioretention provides the following functions:

BMP	On-site	Flow Control	Water Quality	Conveyance	Reference
Non-infiltrating Bioretention	✓ ^a	✓ ^a	✓	✓ ^b	<i>Section 5.8.2</i>

^a On-Site Performance and Flow Control Standards may be partially or completely achieved depending upon ponding depth, contributing area, and use of orifice control.

^b Non-infiltrating bioretention may be connected in series, with the overflows of upstream cells directed to downstream cells to provide conveyance.

- Biofiltration Swales** use vegetation in conjunction with slow and shallow-depth flow for [runoff-water quality](#) treatment. Biofiltration swales may also result in some incidental infiltration to underlying soils. Biofiltration swales described in this volume include:

BMP	On-site	Flow Control	Water Quality ^a	Conveyance	Reference
Basic biofiltration swale			✓	✓	<i>Section 5.8.3</i>
Wet biofiltration swale			✓	✓	<i>Section 5.8.3</i>
Continuous inflow biofiltration swale			✓	✓	<i>Section 5.8.3</i>
Compost-amended biofiltration swale			✓	✓	<i>Section 5.8.3</i>

^a Refer to *Section 3.5.2.2* for more information on Two-BMP Treatment Trains.

- Filter Strips/Drains** are grassy slopes that receive unconcentrated runoff from adjacent hard surfaces such as a parking lots, driveways, or roadways. Filter strips are graded to maintain sheet flow over their entire width. Compost and other amendments can be incorporated into filter strip designs to provide enhanced treatment. Filter strip/drain BMPs described in this volume include:

BMP	On-site	Flow Control	Water Quality	Conveyance	Reference
Vegetated Basic filter strips			✓ ^a	✓	Section 5.8.4
Compost-amended vegetated filter strips (CAVFS)			✓	✓	Section 5.8.4
Media filter drains (MFD)			✓	✓	Section 5.8.4

^a Refer to Section 3.5.2.2 for more information on Two-BMP Treatment Trains.

- **Sand Filters** pass stormwater through a constructed sand bed. Sand filters can be sized as either basic or large BMPs to meet different water quality objectives. The sand filter BMPs described in this volume include:

BMP	On-site	Flow Control	Water Quality ^a	Conveyance	Reference
Basic and large sand filter basins			✓		Section 5.8.5
Sand filter vaults			✓		Section 5.8.5
Linear sand filters			✓		Section 5.8.5

^a Refer to Section 3.5.2.2 for more information on Two-BMP Treatment Trains.

- **Wet Ponds** are constructed stormwater ponds that retain a permanent pool of water (i.e., a wet pool or dead storage) at least during the wet season. The wet pond BMPs described in this volume include:

BMP	On-site	Flow Control	Water Quality ^a	Conveyance	Reference
Wet ponds – basic and large			✓	✓	Section 5.8.6

^a Refer to Section 3.5.2.2 for more information on Two-BMP Treatment Trains.

- **Wet Vaults** are drainage facilities that contain permanent pools of water that are filled during the initial runoff from a storm event. They are similar to wet ponds, except the facility is constructed below grade in a concrete (or similar) vault. The wet vault BMPs described in this volume include:

BMP	On-site	Flow Control	Water Quality ^a	Conveyance	Reference
Wet vaults			✓	✓	Section 5.8.7

^a Refer to Section 3.5.2.2 for more information on Two-BMP Treatment Trains.

- **Stormwater Treatment Wetlands** are similar to wet ponds, except that they also provide a shallow marsh area to allow the establishment of emergent wetland aquatic plants, which improves pollutant removal. In land development situations, wetlands are usually constructed for two main reasons: to replace or mitigate impacts when natural wetlands are filled or impacted by development (mitigation wetlands) or to treat stormwater runoff (stormwater treatment wetlands). Mitigation wetlands may not be used as stormwater treatment facilities because stormwater treatment

functions are not compatible with normal wetland function. The stormwater treatment wetland BMPs described in this volume include:

BMP	On-site	Flow Control	Water Quality ^a	Conveyance	Reference
Stormwater treatment wetlands			✓	✓	Section 5.8.8

^a Refer to Section 3.5.2.2 for more information on Two-BMP Treatment Trains.

- **Combined Detention and Wet Pool BMPs** provide a combination of [water quality runoff](#) treatment and flow control. If combined, the wet pool portion of the facility can often be incorporated below the detention facility to minimize further loss of development area. Combined detention and wet pool facilities described in this volume include:

BMP	On-site	Flow Control	Water Quality ^a	Conveyance	Reference
Combined detention and wet pond		✓	✓	✓	Section 5.8.9
Combined detention and wet vault		✓ ^b	✓	✓	Section 5.8.9
Combined detention and stormwater wetland		✓	✓	✓	Section 5.8.9

^a Refer to Section 3.5.2.2 for more information on Two-BMP Treatment Trains.

^b Standard may be partially or completely achieved depending upon contributing area and minimum orifice size.

- **Oil/Water Separators** remove floating and dispersed oil using gravity. Oil/water separators described in this volume include:

BMP	On-site	Flow Control	Water Quality	Conveyance	Reference
American Petroleum Institute (API baffle type) oil/water separator			✓		Section 5.8.10
Coalescing plate (CP) oil/water separator			✓		Section 5.8.10

- **Proprietary and Emerging Water Quality Treatment Technologies** consist of technologies that are monitored in the state of Washington through the Technology Assessment Protocol – Ecology (TAPE) process. Upon completion of a monitoring program, the monitoring data is evaluated by Ecology and the technology may be approved for use for pretreatment, basic treatment, enhanced treatment, oil treatment, and/or phosphorus treatment. The following technologies have received General Use Level Designations (GULD) approval from Ecology at the time of publication and is provided as a reference. This list is subject to change. [Note: Some manufacturers have multiple media blends available, not all of which have received GULD approval.](#) Refer to Ecology’s website for a list of approved stormwater technologies, including uses and limitations and technologies currently under review

(<https://ecology.wa.gov/Regulations-Permits/Guidance-technical-assistance/Stormwater-permittee-guidance-resources/Emerging-stormwater-treatment-technologies>
www.ecy.wa.gov/programs/WQ/stormwater/newtech/technologies.html). Refer to *Section 3.5* and *Section 5.8.11* for additional Seattle requirements for sizing proprietary technologies for annual maintenance.

BMP	On-site	Flow Control	Water Quality	Conveyance	Reference
Bay Filter® (Silica sand, perlite, activated alumina media)			✓		<i>Section 5.8.11</i>
Filterra®			✓		<i>Section 5.8.11</i>
FloGard Perk Filter® (Zeolite, perlite, carbon media)			✓		<i>Section 5.8.11</i>
Stormwater Management StormFilter (StormFilter®) (Zeolite, perlite, granular activated carbon media)			✓		<i>Section 5.8.11</i>
MWS- Linear Modular Wetland®			✓		Section 5.8.11
BioPod®			✓		Section 5.8.11
Kraken®			✓		Section 5.8.11

CHAPTER 3 – BMP SELECTION AND SIZING APPROACH

This chapter describes the steps for selecting appropriate stormwater BMPs and is organized into the following five sections:

- *Section 3.1* – Determine Dispersion Feasibility
- *Section 3.2* – Determine Infiltration Feasibility
- *Section 3.3* – BMP Selection for On-site Stormwater Management
- *Section 3.4* – BMP Selection for Flow Control
- *Section 3.5* – BMP Selection for Water Quality Treatment

Since dispersion and infiltration BMPs can serve multiple functions (on-site stormwater management, flow control, or water quality treatment), the process for evaluating feasibility for those types of BMPs is described first. Following the dispersion and infiltration feasibility determination are specific steps related to the minimum requirements (on-site stormwater management, flow control, and/or water quality treatment) that apply to a specific project. To determine which of these three minimum requirements apply to a project, refer to the 7-step approach in *Volume 1, Chapter 2*. Note that more than one, two, or all three of these minimum requirements may apply.

3.1. Determine Dispersion Feasibility

This section provides a two-step procedure for evaluating the feasibility of dispersion for a site (refer to *Section 2.4* for a list of dispersion BMPs).

Each of the following steps is outlined in more detail in the subsequent sections.

- *Step 1* – Evaluate horizontal setbacks and site constraints
- *Step 2* – Evaluate use of dispersion to meet minimum requirements

Step 1: Evaluate horizontal setbacks and site constraints

Assess the following to determine dispersion feasibility for the site:

Horizontal Setbacks

Horizontal setbacks vary depending on the type of dispersion BMP selected. Refer to the following sections for horizontal setback requirements:

- *Section 5.3.3* – Splashblock downspout dispersion
- *Section 5.3.4* – Trench downspout dispersion
- *Section 5.3.5* – Sheet flow dispersion
- [Section 5.3.6](#) – Concentrated flow dispersion
- [Section 5.3.7 – Sidewalk/trail compost-amended strip](#)

Site Constraints

- Steep Slope or Landslide-prone Areas – the dispersion flowpath is not typically permitted within landslide-prone areas or within a setback of 10 times the height of the steep slope to a maximum of 500 feet above a steep slope area.
- Septic Systems and Drain Fields – the dispersion flowpath is not permitted within 10 feet of a proposed or existing septic system or drainfield.
- Contaminated Sites and Landfills – the dispersion flowpath is not permitted within 100 feet of a contaminated site or landfill (active or closed).

Flowpath/Flow Path Requirements

Dispersion BMPs have minimum requirements for a vegetated [flowpath/flow path](#) that can be difficult to achieve in an urban environment. Assess the following:

- Full dispersion – the flowpath shall be directed over a minimum of 100 feet of vegetation.
- Sheet flow dispersion – the flowpath shall be directed over a minimum of 10 feet of vegetation.
- Concentrated flow dispersion, trench downspout dispersion and splashblock downspout dispersion – the flowpath shall be directed over a minimum of 25 feet of vegetation.

Step 2: Evaluate use of dispersion to meet minimum requirements

If dispersion is considered feasible for the site, evaluate the feasibility of individual dispersion BMPs (*Section 5.3*) when selecting BMPs in *Section 3.3* – On-site Stormwater Management, *Section 3.4* (Flow Control), and *Section 3.5* (Water Quality Treatment).

3.2. Determine Infiltration Feasibility

This section provides step-by-step procedures for evaluating the feasibility of infiltration for a site and determining design infiltration rates for facility design. Refer to *Section 2.5* for a list of infiltration BMPs.

Each of the following steps is outlined in more detail in the subsequent sections.

- *Step 1* – Evaluate Infiltration Investigation Map
- *Step 2* – Evaluate horizontal setbacks and site constraints
- *Step 3* – Conduct subsurface investigation and evaluate vertical separation requirements
- *Step 4* – Conduct infiltration testing
- *Step 5* – Determine design infiltration rate
- *Step 6* – Conduct groundwater monitoring, receptor characterization, and mounding analysis, if applicable
- *Step 7* – Evaluate use of infiltration to meet minimum requirements

Step 1: Evaluate Infiltration Investigation Map

- Determine if Seattle has mapped the site as “infiltration investigation not required to meet the on-site stormwater management, flow control, or water quality treatment requirements.” Based on some of the required setbacks and known infiltration restrictions, the City has mapped areas where infiltration is [expected to be limited due to proximity to environmentally critical area \(ECA\), steep slopes, and known landfills](#) ([www.seattle.gov/sdci/codes/codes-we-enforce-\(a-z\)/stormwater-codes](http://www.seattle.gov/sdci/codes/codes-we-enforce-(a-z)/stormwater-codes)www.seattle.gov/dpd/codesrules/codes/stormwater).
- [The map is advisory and does not include all site constraints.](#) If the site is [fully](#) within an area that is mapped, further infiltration investigation to meet the on-site stormwater management, flow control, or water quality treatment requirements is not required. [Continue to s](#)Select other non-infiltrating BMPs in *Section 3.3* (on-site stormwater management), *Section 3.4* (flow control), and *Section 3.5* (water quality treatment) [to meet these requirements.](#) [If the site is partially within a mapped area or not at all within the mapped area, the following steps below shall be used to determine if infiltration is feasible on any portion of the site.](#)

Step 2: Evaluate Horizontal Setbacks and Site Constraints

Evaluate the following criteria related to limitations, horizontal setbacks, and contaminated soil or groundwater. For any portion of the site that falls within an area that limits or restricts infiltration BMPs, further infiltration investigation to meet the on-site stormwater management, flow control, or water quality treatment requirements is not required. An infiltration feasibility flow chart is presented in Figure 3.1.

Assess the following to determine infiltration feasibility for the site:

Horizontal Setbacks

For infiltrating bioretention and rain gardens, horizontal setbacks are measured from the vertical extent of the cell or basin (e.g., top of the bioretention soil). For infiltration chambers/[vaults](#), horizontal setbacks are measured from the outside bottom of the structure. For all other infiltration BMPs, horizontal setbacks are measured from edge of the aggregate.

Infiltration is not permitted in the following areas:

- Within 5 feet from property lines. As an exception, no setback is required from the property line abutting the public right-of-way.
- Within 10 feet of another infiltration facility.
- Within the following setbacks from onsite and off-site structures:
 - When runoff from less than 5,000 square feet of impervious surface area is infiltrated on the site, the infiltration BMP shall not be within 5 feet from a building without a basement, and/or 10 feet from a building with a basement.
 - When runoff from 5,000 square feet or more of impervious surface area is infiltrated on the site, a building shall not intersect with a 1H:1V slope from the bottom edge of an infiltration BMP. The resulting setback shall be no less than 5 feet from a building without a basement and/or 10 feet from a building with a basement. For setbacks from buildings or structures on adjacent lots, potential buildings or structures should be considered for future build-out conditions.

Note:

- If the development site is located within a peat settlement prone area, infiltration is required in order to achieve no net reduction in surface runoff volume that is infiltrated in the existing condition. Refer to SMC, Section 25.09.110.G. [Guidance and sizing for infiltration facilities provided in SDCI Director's Rule 12-2008 – Infiltration Facilities in Peat Settlement-prone Areas.](#)
- If development is located in an area with no off-site point of discharge (*Section 4.3.2-7*) infiltration may be feasible, but the drainage control plan shall be prepared by a civil engineer.
- Deviations from these site constraints and setbacks shall be approved by the Director and require a report stamped and signed by a licensed professional stating that the siting of an infiltration BMP within a setback will not cause an adverse impact to the public or the environment.
- The thresholds above are based on impervious surface area rather than hard surface area to exclude permeable pavement surfaces (non-infiltrating BMPs) from the threshold.

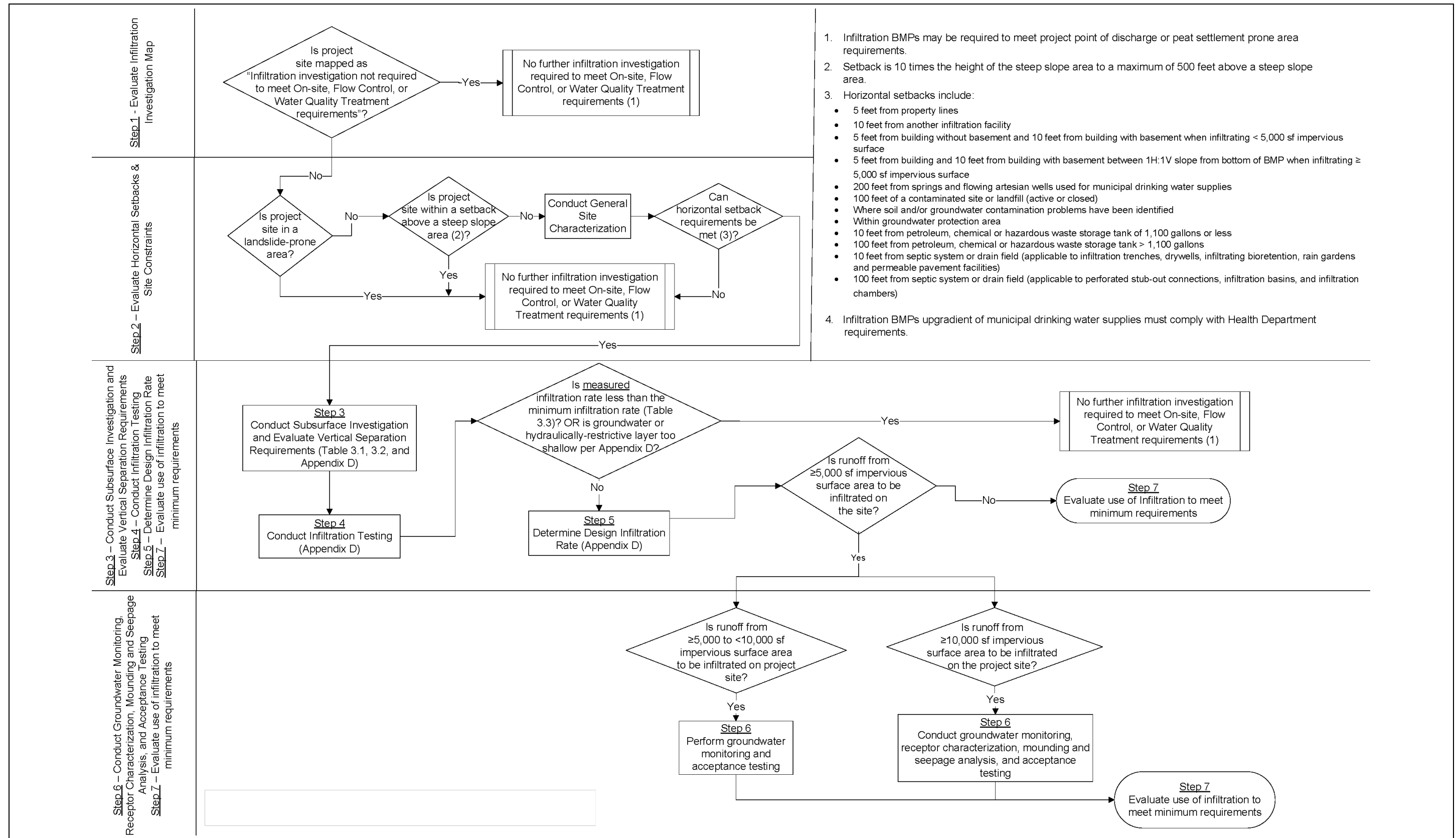

Figure 3.1. Infiltration Feasibility.

[Note: This page is blank for back of 11 x 17 figure]

Site Constraints

- Steep Slope or Landslide-prone Areas – infiltration is limited within landslide-prone areas or within a setback of 10 times the height of the steep slope to a maximum of 500 feet above a steep slope area (as defined by the regulations for ECAs [SMC, Section 25.09.020]). Infiltration within this area may be feasible provided a [detailed](#) slope stability analysis is completed by a licensed engineer or engineering geologist. The analysis shall determine the effects that infiltration would have on the landslide-prone or steep slope area and adjacent properties.
- Septic Systems and Drain Fields – Within 10 feet of proposed or existing septic systems or drain fields (applicable to infiltration trenches, drywells, infiltrating bioretention, rain gardens, and permeable pavement facilities). Other infiltration BMPs (perforated stub-out connections, infiltration basins, and infiltration chambers/[vaults](#)) are not permitted within 100 feet of proposed or existing septic systems or drain fields.
- Drinking Water Supply Wells or Springs – Within 100 feet of drinking water supply wells or springs used for drinking water.
- Groundwater Protection Area – Within a groundwater protection area unless approved by the King County Department of Health and the Director. If approved, water quality treatment per *Section 4.5.2.2 (Imported Soil Requirements for Bioretention Systems)* may be required.
- Contaminated Sites and Landfills:
 - Within 100 feet of a contaminated site or landfill (active or closed). For projects where runoff from 5,000 square feet or more of impervious surface area will be infiltrated on the site, infiltration within 500 feet up-gradient or 100 feet down-gradient of a contaminated site or landfill (active or closed) requires analysis and approval by a licensed hydrogeologist.
 - Where soil and/or groundwater contamination problems have been identified, including, but not limited to, the following:
 - EPA Superfund Program site list (www.epa.gov/superfund/sites/index.htm)
 - EPA Resource Conservation and Recovery Act (RCRA) Program site list (www.epa.gov/epawaste/hazard/correctiveaction/facility/index.htm)
 - EPA mapping tool that plots the locations of Superfund and RCRA-regulated sites (www2.epa.gov/cleanups/cleanups-my-community)
 - Ecology regulated contaminated sites (<https://ecology.wa.gov/Regulations-Permits/Guidance-technical-assistance/Site-Register-lists-and-datawww.ecy.wa.gov/fs>)
 - Ecology Toxics Cleanup Program website (<https://ecology.wa.gov/Spills-Cleanup/Contamination-cleanup/Cleanup-sites/Toxic-cleanup-siteswww.ecy.wa.gov/cleanup.html>)
- ~~Underground or Above-Ground~~[Petroleum, Chemical, or Liquid Hazardous Waste](#) Storage Tanks:
 - Within 10 feet of an underground or above ground storage tank or connecting underground pipes when the capacity of the tank and pipe system is 1,100 gallons

- or less. ~~(Applicable to tanks used to store petroleum products, chemicals, or liquid hazardous wastes.)~~
- Within 100 feet of an underground or above ground storage tank or connecting underground pipes when the capacity of the tank and pipe system is greater than 1,100 gallons. ~~(Applicable to tanks used to store petroleum products, chemicals, or liquid hazardous wastes.)~~

Step 3: Conduct Subsurface Investigation and Evaluate Vertical Separation Requirements

Note that the applicant may choose to perform Step 3 and Step 4 in either order (i.e., Step 4 – Conduct Infiltration Testing can be done before Step 3 – Conduct Subsurface Investigation and Evaluate Vertical Separation Requirements).

Subsurface Investigations

Subsurface investigations are required to identify subsurface and groundwater conditions that may affect performance of the infiltration facility. Investigations shall be performed at the location of the proposed facility or as close as possible, but no more than 50 feet away. The number and type of subsurface investigations required are provided in Table 3.1 and Table 3.2. Seasonal timing for infiltration testing and groundwater monitoring requirements for infiltration facilities can impact project schedules. Subsurface investigations are preferred to be scheduled during the wet season, between November and March. Larger projects may want to consult with a licensed professional early in project development. Seasonal timing, depth of subsurface investigations, and investigation procedures are provided in *Appendix D*.

This manual includes four types of subsurface investigations:

- Simple subsurface investigation
- Standard subsurface investigation
- Comprehensive subsurface investigation
- Deep infiltration subsurface investigation

Subsurface investigation is required for the entire site or portion(s) of the site that have not been excluded based on information reviewed in Steps 1 and 2.

The type of subsurface investigation required for a project is provided in Table 3.1 and Table 3.2 and varies by the impervious surface area infiltrated on site. Subsurface investigation procedures are provided in *Appendix D*. If the infiltration testing report is required to be prepared by a licensed professional, then the subsurface investigation shall also be prepared by a licensed professional.

Projects shall document the results of the required subsurface investigation and evaluation of vertical separation requirements. The information to be contained in this report is provided in *Appendix D*.

Table 3.2 provides information for deep infiltration BMPs. Deep infiltration BMPs are typically used to direct stormwater past surface soil layers that have lower infiltration rates and into

well-draining soil. The depth of the soil layers with lower infiltration rates can vary significantly, so the technique required to reach the well-draining soils will also vary.

Table 3.1. Minimum Investigation and Testing Requirements for Shallow Infiltration BMPs.

Impervious Area Infiltrated on the Site ^{a,h,i}	Step 3		Step 4		Step 6				
	Subsurface Investigation		Infiltration Testing		Groundwater Monitoring		Characterization of Infiltration Receptor	Groundwater Mounding and Seepage Analysis	Acceptance Testing
	Minimum Number	Type	Minimum Number	Type	Minimum Number of Wells	Duration and Frequency			
<2,000 ft ²	1 per facility AND at least 1 per 150 linear feet of a facility ^{c,d}	Simple subsurface investigation	1 per facility AND at least 1 per 150 linear feet of a facility ^{c,d}	Simple Infiltration Test ⁱ	0	NA	No	No	No
≥2,000 to <5,000 ft ²		Standard subsurface investigation		Simple Infiltration Test ⁱ or Small PIT; if ≥2,000 ft ² of the site infiltration will occur within a single facility, ^e the Small PIT ^f method is required	0	NA	No	No	No
≥5,000 to <10,000 ft ²		Comprehensive subsurface investigation ^h	1 per facility AND at least 1 per 150 linear feet of a facility ^{c,d}	Small PIT ^f	1	Monthly for at least 1 wet season; monthly for at least 1 year if within 200 feet of a designated receiving water ^b	No	No	Yes
≥10,000 ft ² to <1 acre		Small or Large PIT ^{f,k}	Comprehensive subsurface investigation ^h	Small PIT ^f	3	Monthly for at least 1 year ^b	Yes, for infiltration basins	Yes ^g	Yes
≥1 acre									

Note: Deviations from the minimum requirements in this table, when recommended and documented by the licensed professional, may be approved by the Director. If the licensed professional determines continuity of subsurface materials based on site investigations or if acceptance testing will be done during construction then fewer tests may be approved. Designer shall be prepared to make allowances to the design during construction if site conditions differ than assumed for the design or if the acceptance test during construction determines that the infiltration rate is lower than assumed for the design.

^a Site is defined for SFR and Parcel projects as the project area; for Trail, Sidewalk or Roadway projects, it is defined by one intersection to the other and blocks may vary in length.

^b If the project site is within 200 feet of tidal waters, groundwater data capturing low/high tide fluctuation for one calendar year shall be collected to determine if groundwater at the project is influenced by tidal fluctuations. Groundwater monitoring is not required if available groundwater elevation data within 50 feet of the proposed facility shows the highest

- measured groundwater level to be at least 10 feet below the bottom of the proposed infiltration facility or if the initial groundwater measurement is more than 15 feet below the bottom of the proposed infiltration facility.
- c For bioretention or rain gardens, a facility refers to either a single cell, or a series of cells connected in series, with the overflows of upstream cells directed to downstream cells to provide additional flow control and/or treatment and conveyance.
 - d Preferably, the investigation is conducted at the location of the proposed infiltration facility, but it ~~shall~~ be within 50 feet of the facility location.
 - e A single facility is defined as a facility that has at least a 10 foot separation distance from another infiltration facility, measured from the closest vertical extent of maximum ponding before overflow, or for bioretention and rain gardens, the maximum vertical extent of the top of the bioretention soil or compost amended soil.
 - f The investigation and infiltration testing report shall be prepared by a licensed professional.
 - g Groundwater mounding and seepage analysis is required where the depth to the seasonal high groundwater elevation or hydraulically-restrictive material is less than 15 feet below the bottom of the proposed infiltration facility.
 - h ~~For projects where runoff from 5,000 square feet or more of impervious surface area will be infiltrated on the site, infiltration within 500 feet up-gradient or 100 feet down-gradient of a contaminated site or landfill (active or closed) requires analysis and approval by a licensed hydrogeologist. For projects with infiltration facilities within 500 feet up-gradient or 100 feet down-gradient of a contaminated site or landfill (active or closed), analysis and approval by a licensed hydrogeologist is required if runoff from 5,000 square feet or more of impervious surface area will be infiltrated on the site.~~
 - i The Simple Infiltration Test is not allowed for projects with no off-site point of discharge (*Section 4.3.2-4*). These projects shall use a Small PIT.
 - j Permeable pavement not included in the impervious area total.
 - k A small scale PIT may be substituted if the site has a high infiltration rate (>4 in/hr), making a large scale PIT difficult, and the site geotechnical investigations suggest uniform subsurface characteristics.

Table 3.2. Minimum Investigation and Testing Requirements for Deep Infiltration BMPs.

Impervious Area Infiltrated on the Site ^{a,e}	Step 3		Step 4		Step 6				
	Subsurface Investigations		Infiltration Tests		Groundwater Monitoring		Characterization of Infiltration Receptor	Groundwater Mounding and Seepage Analysis	Acceptance Testing
	Minimum Number and Location	Type	Minimum Number and Location	Type	Minimum Number of Wells	Duration and Frequency			
<10,000 ft ²	One at every deep infiltration location	Deep infiltration subsurface investigation ^d	One at every deep infiltration location	Deep Infiltration Test	3	Monthly for at least 1 wet season; monthly for at least 1 year if within 200 feet of a designated receiving water ^b	No	No	Yes
≥10,000 ft ²						Monthly for at least 1 year ^b	Yes	Yes ^c	Yes

Note: Deviations from the minimum requirements in this table, when recommended and documented by the licensed professional, may be approved by the Director. If the licensed professional determines continuity of subsurface materials based on site investigations or if acceptance testing will be done during construction then fewer tests may be approved. Designer shall be prepared to make allowances to the design during construction if site conditions differ than assumed for the design or if the acceptance test during construction determines that the infiltration rate is lower than assumed for the design.

- ^a Site is defined for SFR and Parcel projects as the project area; for Trail, Sidewalk or Roadway projects, it is defined by one intersection to the other and blocks may vary in length.
- ^b If the project site is within 200 feet of tidal waters, groundwater data capturing low/high tide fluctuation for one calendar year shall be collected to determine if groundwater at the project is influenced by tidal fluctuations. Groundwater monitoring is not required if available groundwater elevation data within 50 feet of the proposed facility shows the highest measured groundwater level to be at least 10 feet below the bottom of the proposed facility.
- ^c Groundwater mounding and seepage analysis is required where the depth to the seasonal high groundwater elevation or hydraulically-restrictive material is less than 15 feet below the bottom of the proposed infiltration facility.
- ^d For projects where runoff from 5,000 square feet or more of impervious surface area will be infiltrated on the site, infiltration within 500 feet up-gradient or 100 feet down-gradient of a contaminated site or landfill (active or closed) requires analysis and approval by a licensed hydrogeologist.

^e [Permeable pavement not included in the impervious area total.](#)

Vertical Separation Requirements

Vertical separation requirements shall be evaluated when performing a subsurface investigation. Infiltration BMPs require a minimum vertical separation from the lowest elevation of the facility to the underlying groundwater table or hydraulically-restrictive material (*Appendix D, Section D-2.2.4*). The vertical separation requirements for shallow infiltration BMPs depend upon the type of subsurface investigation required and the seasonal timing of the geotechnical exploration conducted to evaluate clearances.

Step 4: Conduct Infiltration Testing

This manual includes four methods of field infiltration testing to determine the measured infiltration rate:

- Simple Test (Small-scale infiltration test)
- Small Pilot Infiltration Test (PIT)
- Large PIT
- Deep Infiltration Test

The type of infiltration test required for a project is provided in Table 3.1 and Table 3.2 and varies by the impervious surface area routed to infiltration BMPs on a site. Infiltration testing procedures are provided in *Appendix D*. The Small PIT, Large PIT, and Deep Infiltration Test reports shall be prepared by a licensed professional.

The minimum allowed infiltration rates are provided in Table 3.3.

Table 3.3. Minimum Measured Infiltration Rates.

Infiltration BMP	Minimum Measured Infiltration Rate for On-site List Approach (in/hr)	Minimum Allowed Measured Infiltration Rate for Meeting Flow Control, Water Quality Treatment, and On-site Performance Standards (in/hr)
Infiltration Trenches	5	5
Drywells	5	5
Infiltrating Bioretention without underdrain	0.6	0.6
Infiltrating Bioretention with underdrain	0.3	No minimum
Rain Gardens	0.3	Not applicable (only for On-site List Approach)
Permeable Pavement Facility	0.3	0.3 ^b
Permeable Pavement Surface	0.3 ^a	No minimum
Sidewalk/Trail Compost-Amended Strip	0.3^a	No minimum
Perforated Stub-out Connections	0.3	Not applicable (only for On-site List Approach)
Infiltration Basins	Not applicable	0.6
Infiltration Chambers/Vaults	Not applicable	0.6

^a Infiltration testing not required, only necessary to prove infeasibility.

^b No minimum infiltration rate if underdrain is installed.

Step 5: Determine Design Infiltration Rate

- The measured infiltration rate determined in Step 4 shall be reduced using correction factors to account for site variability and number of tests conducted, uncertainty of the test method, and potential for long-term clogging due to siltation and bio-buildup. The corrected infiltration rate is considered the long-term or design infiltration rate and is used for all BMP sizing calculations. Correction factors and methodology is provided in *Appendix D, Section D-4*.

Step 6: Conduct Groundwater Monitoring, Receptor Characterization, Mounding and Seepage Analysis, and Acceptance Testing (as applicable)

Groundwater Monitoring

Groundwater monitoring is required when runoff from more than 5,000 square feet of impervious surface area is infiltrated on the site (refer to Table 3.1). If the results of this groundwater monitoring indicate that adverse conditions could occur, as determined by a licensed professional, the infiltration facility shall not be built. Groundwater elevation data shall be used to evaluate the bottom of the facility against the vertical separation requirements in *Appendix D, Section D-2.2.4* to determine infiltration feasibility.

Characterization of the Infiltration Receptor

For projects proposing an infiltration basin or deep infiltration BMPs to infiltrate runoff from more than 10,000 square feet of impervious surface area, the infiltration receptor (unsaturated and saturated soil receiving the stormwater) shall be characterized (refer to Table 3.1 and *Appendix D*). If the results of this characterization indicate that adverse conditions could occur, as determined by a licensed professional, the infiltration facility shall not be built. Refer to *Appendix D, Section D-6*.

Groundwater Mounding and Seepage Analysis

A mounding analysis shall be required for projects that will be infiltrating 10,000 square feet or more of impervious surface area on the site and where the depth to the seasonal high groundwater elevation or hydraulically-restrictive material is less than 15 feet below the bottom of the proposed BMP. If the results of the mounding analysis indicate that adverse conditions could occur, as determined by a licensed professional, the infiltration facility shall not be built. Refer to *Appendix D, Section D-7*.

Acceptance Testing

Thresholds for acceptance testing are summarized in Table 3.1 and Table 3.2. [Acceptance testing requirements are provided in Appendix D, Section D-8](#). In general, acceptance testing shall be performed for infiltration BMPs receiving runoff from greater than 5,000 square feet of impervious surface area; however acceptance testing may also be required for infiltration BMPs receiving runoff from a smaller contributing area. As an exception, all permeable pavement facilities and surfaces are required to perform acceptance testing per *Section 5.4.6.5*.

At a minimum, the acceptance testing shall demonstrate that the infiltration facility performs at the design infiltration rate.

Acceptance testing of deep infiltration BMPs shall consist of the infiltration testing procedures for deep infiltration wells described in *Appendix D, Section D-4*.

Step 7: Evaluate use of infiltration to meet minimum requirements

- If infiltration is considered feasible, evaluate the feasibility of infiltration BMPs when selecting BMPs in *Section 3.3* (on-site stormwater management), *Section 3.4* (flow control), and *Section 3.5* (water quality treatment).

3.3. BMP Selection for On-site Stormwater Management

If the on-site stormwater management requirement is triggered, it can be met by using the On-Site List Approach or the On-site Performance Standard. The procedures for selecting BMPs under these options are provided in the following sections. Selection of BMPs shall build upon site assessment and planning information described in *Volume 1, Chapter 7.2* and *Volume 3, Sections 3.1 and 3.2*. Flow control and water quality treatment requirements may also apply (refer to *Sections 3.4 and 3.5*).

3.3.1. On-site List Approach

If the on-site stormwater management requirement is triggered (per *Volume 1, Section 4.3.2*) and the On-site List Approach is selected as the method for compliance, follow the steps presented below to select the appropriate BMP(s) for a given project. [The City has also prepared a spreadsheet tool \(On-site Stormwater Management – List Approach Calculator\) to help users document and implement the On-Site List Approach. Refer to SDCI's Stormwater Code web page to download the latest version of the spreadsheet tool: \[www.seattle.gov/sdci/codes/codes-we-enforce-\\(a-z\\)/stormwater-code\]\(http://www.seattle.gov/sdci/codes/codes-we-enforce-\(a-z\)/stormwater-code\)](#)

Step 1: Determine if Dispersion and Infiltration are Feasible

Refer to *Section 3.1* and *Section 3.2*.

Step 2: Calculate Areas by Surface Type

For each project type, divide the project area into hard surface areas with distinct drainage pathways ([e.g., downspouts, collection points, and grading toward leaving a project site](#)) and conduct a BMP evaluation for each surface sub area.

Step 3: Refer to Applicable On-site List(s)

Identify the On-site List(s) in [SMC, Section 22.805.070](#) or *Volume 1, Section 5.2* for the project type(s) that apply to the project. The On-site Lists provide On-site BMPs prioritized by category, with Category 1 comprising the first priority BMPs.

Step 4: Evaluate BMPs by Category

For each hard surface area type (i.e., roof or non-roof [ground-related surface]), evaluate the On-site BMP(s) as described in Steps 5 through 7 below. Evaluate the feasibility of all On-site BMPs in the first category before moving on to the next category. Note that the On-site List Approach assumes each hard surface area may be evaluated separately. Proposals to use BMPs in series (i.e., multiple bioretention cells) may require modeling using the On-site Performance Standard. Refer to the *General Design Requirements* in *Chapter 4* for additional requirements that may affect the design and placement of BMPs on the site.

Step 5: Evaluate Feasibility of Category 1 BMPs

Determine feasibility of the BMP(s) in Category 1. The BMP is considered infeasible if one of the following applies:

- The BMP is considered infeasible per the “Infeasibility Criteria” provided for the BMP in *Appendix C*, which includes applicable Design Criteria and Site Considerations provided for the BMP in *Chapter 5*.
- Competing needs (e.g., historic preservation laws, health and safety standards) as provided in SMC, Section 22.805.070 conflict with the BMP.
- The BMP size as detailed in the sizing for the On-site List Approach in *Chapter 5* cannot be met.

Note: Some BMPs that are not sized can meet the requirements for a sub-area. Refer to *Credit for On-site List Approach* in *Chapter 5*.

Step 6: Select Category 1 BMP(s)

If any of the Category 1 BMPs are feasible for a surface (or surface “sub area”), then a Category 1 BMP shall be used to manage runoff for a given hard surface area (or surface sub area). [Any of the feasible BMPs within the category can be used.](#) Size the BMPs for the contributing area per the On-site List Approach sizing requirements in *Chapter 5*.

Step 7: Document Infeasibility of Category 1 BMPs (if applicable)

If all the Category 1 BMPs are deemed infeasible, infeasibility shall be documented. The applicant shall provide a completed On-site List Requirement Infeasibility Criteria Checklist (refer to the tables provided in *Appendix C*) or a narrative description and rationale with substantial evidence sufficient to explain and justify the applicant’s conclusion that the On-site BMPs are infeasible.

If there are remaining unmanaged hard surfaces, proceed to Step 8. If all hard surfaces are managed, the BMP selection process for the On-site List Approach is complete.

Step 8: Evaluate/Select Category 2 BMPs

If there are remaining unmanaged hard surfaces, evaluate the On-site BMPs in Category 2 using the same approach described in Steps 5 through 7.

If all hard surfaces are managed, the BMP selection process for the On-site List Approach is complete.

Step 9: Evaluate/Select Category 3 BMPs

If there are remaining unmanaged hard surfaces, evaluate the On-site BMPs in Category 3 using the same approach described in Steps 5 through 7.

If all hard surfaces are managed, the BMP selection process for the On-site List Approach is complete.

Step 10: Evaluate/Select Category 4 BMPs (SFR and Parcel-based projects only)

If there are remaining unmanaged hard surfaces, evaluate the On-site BMPs in Category 4 using the same approach described in Steps 5 through 7.

If all hard surfaces are managed, the BMP selection process for the On-site List Approach is complete.

Step 11: Evaluate/Select Category 5 BMPs (SFR and Parcel-based projects only)

If there are remaining unmanaged hard surfaces, evaluate the On-site BMPs in Category 5 using the same approach described in Steps 5 through 7.

If all hard surfaces are managed, the BMP selection process for the On-site List Approach is complete. If none of the BMPs in the appropriate categories on the On-site List are feasible, then no further evaluation is required for that surface and the BMP selection process for the On-site List Approach is considered to be complete (refer to SMC, Section 22.805.070).

3.3.2. On-site Performance Standard

If the on-site stormwater management requirement is triggered and the On-site Performance Standard is selected as the method for compliance, follow the steps presented below to select the appropriate BMP(s) for a given project.

Step 1: Determine if Dispersion and Infiltration are Feasible

Refer to *Section 3.1* and *Section 3.2*.

Step 2: Select BMP(s)

Select a BMP, or multiple BMPs, to meet the On-Site Performance Standard. Refer to the *General Design Requirements* in *Chapter 4* for additional requirements that may affect the design and placement of BMPs on the site. Refer to *Chapter 5* of this volume for BMP applicability, site suitability, and design criteria. Note that in order to meet the On-Site Performance Standard, the selected BMP(s) will most likely need to include infiltration.

Step 3: Use Modeling Approach for BMP design

The Modeling Approach for each BMP design shall be applied. Refer to *Section 4.1.3* and *Appendix F, Section F-4* for detailed information on modeling requirements/guidelines.

3.4. BMP Selection for Flow Control

If the flow control minimum requirement is triggered, follow the steps presented below to select the appropriate flow control BMPs for a given project. All projects shall use On-site BMPs to the maximum extent feasible to meet Flow Control Minimum Requirements per SMC 22.805.080.B. In addition, On-site Stormwater Management and Water Quality Treatment Requirements may apply (refer to *Sections 3.3 and 3.5*). [The City has also prepared a spreadsheet tool \(Pre-Sized Flow Control Calculator\) to help users document and implement the flow control BMP selection process for small sites \(<10,000 square feet of new and replaced hard surface area\). Refer to SDCI's Stormwater Code web page to download the latest version of the spreadsheet tool: \[www.seattle.gov/sdci/codes/codes-we-enforce-\\(a-z\\)/stormwater-code\]\(http://www.seattle.gov/sdci/codes/codes-we-enforce-\(a-z\)/stormwater-code\)](#)

Step 1: Determine if Dispersion and Infiltration are Feasible

Refer to *Section 3.1* and *Section 3.2*.

Step 2: Determine if Water Quality Treatment requirements also apply

If the minimum requirements for water quality treatment also apply to a project, look for opportunities to use flow control BMPs that can also meet water quality treatment requirements (refer to *Chapter 2* and *Chapter 5* in this volume).

Step 3: Select Flow Control BMP(s)

Select a flow control BMP, or multiple BMPs (*refer to Chapter 2*). Refer to the *General Design Requirements* in *Chapter 4* for additional requirements that may affect the design and placement of BMPs on the site. Refer to *Chapter 5* of this volume for applicability, site suitability, and design criteria. Select flow control BMPs that best integrate with on-site stormwater management to the maximum extent feasible.

Step 4: Use Pre-sized or Modeling Approach for BMP Design

For projects with 10,000 square feet or more new and replaced hard surface area, use the Modeling Approach for BMP design (Step 4b). For sites with less than 10,000 square feet of new and replaced hard surface area, either the Pre-Sized Approach or Modeling Approach for BMP design may be used (Steps 4a or 4b).

Step 4a: Use Pre-sized Approach for BMP design

Apply the Pre-sized Approach for BMP design (refer to *Section 4.1.2*). The designer may also choose to use the Modeling Approach (refer to Step 4b).

Step 4b: Use Modeling Approach for BMP design

Apply the Modeling Approach for BMP design. Refer to *Section 4.1.3* and *Appendix F* for modeling guidelines.

Table 3.4 summarizes flow control BMPs that can be used to meet Pre-developed Forested, Pre-developed Pasture, and/or Peak Control Standards. Refer to each BMP section in *Chapter 5* for more specific information on modeling to meet flow control standards.

Table 3.4. Flow Control BMPs and Applicable Standards.

Flow Control BMP	Applicable Flow Control Standards			Section Reference
	Forested	Pasture	Peak	
Tree Planting and Retention	A	A	A	Section 5.2
Full Dispersion	B	B	✓	Section 5.3.2
Splashblock Downspout Dispersion	B	B	✓	Section 5.3.3
Trench Downspout Dispersion	B	B	B	Section 5.3.4
Sheet Flow Dispersion	B	B	B	Section 5.3.5
Concentrated Flow Dispersion	B	B	B	Section 5.3.6
Infiltration Trenches	B	B	B	Section 5.4.2
Drywells	B	B	B	Section 5.4.3
Infiltrating Bioretention without underdrain	✓	✓	✓	Section 5.4.4
Infiltrating Bioretention with underdrain	C	C	C	Section 5.4.4
Permeable Pavement Facilities	✓	✓	✓	Section 5.4.6
Infiltration Basins	✓	✓	✓	Section 5.4.8
Infiltration Chambers/Vaults	✓	✓	✓	Section 5.4.9
Rainwater Harvesting	✓	✓	✓	Section 5.5.1
Vegetated Roof Systems	A	A	A	Section 5.6.1
Permeable Pavement Surfaces	D	D	D	Section 5.6.2
Detention Ponds	✓	✓	✓	Section 5.7.1
Detention Pipes	E	E	E	Section 5.7.2
Detention Vaults/Chambers	E	E	E	Section 5.7.3
Detention Cisterns	E	E	✓	Section 5.7.4
Non-infiltrating Bioretention	C	C	C	Section 5.8.2
Combined Detention and Wet Pond	✓	✓	✓	Section 5.8.9
Combined Detention and Wet Vault	E	E	E	Section 5.8.9
Combined Detention and Stormwater Wetland	✓	✓	✓	Section 5.8.9

✓ – Standard achieved.

A – Standard may be partially achieved.

B – Standard may be partially or completely achieved depending upon underlying soil type.

C – Standard may be partially or completely achieved depending upon ponding depth, degree of underdrain elevation (if applicable), infiltration rate (if applicable), contributing area, and use of orifice control.

D – Standard may be partially or completely achieved depending upon subgrade slope, infiltration rate of subgrade soil, and whether aggregate subbase is laid above or below surrounding grade.

E – Standard may be partially or completely achieved depending upon contributing area and minimum orifice size.

3.5. BMP Selection for Water Quality Treatment

If the Water Quality Treatment Minimum Requirement is triggered (refer to *Volume 1, Section 5.4.2*), this section describes the step-by-step process for selecting the type of treatment BMPs that apply to individual projects, as well as the physical site features that can impact water quality treatment BMP selection. All projects shall use On-site BMPs to the maximum extent feasible to meet Water Quality Treatment Minimum Requirements per SMC 22.805.090.B. Refer to *Section 3.5.2* for additional detail on BMP selection for the following water quality treatment performance goals – oil control, phosphorus, enhanced, and basic.

3.5.1. Selection Steps

If one or more Water Quality Treatment Minimum Requirements are triggered, designers should follow the steps presented below and in Figure 3.2 to select the appropriate water quality treatment BMPs for a given project. In addition, On-site Stormwater Management and Flow Control Requirements may apply (refer to *Sections 3.3 and 3.4*).

Step 1: Determine the Associated Pollutants of Concern

- Determine the pollutants of concern and potential loads through an analysis of the proposed use(s) of the project site. Identify areas of the project site associated with the production of metals, organic compounds, and other toxic wastes that can be entrained in precipitation and runoff (through air pollution or deposition on the ground surface).
- Determine the potential for high sediment input. Particularly, sites with a large amount of fine-grained particles, such as silt and sand, can clog infiltration and filtration BMPs. Pretreatment may be required to remove total suspended solids (TSS) for infiltration and filtration BMPs (refer to *Section 4.4*). High TSS loads can also hinder the function of oil/water separators, especially coalescing plate (CP) separator systems, if sediment clogs the coalescing plates.
- Mean, or upper confidence limit, TSS loadings from Table 3.5 may be assumed when there is an absence of more site specific information.

Table 3.5. Zoning Categorization and TSS Characteristics.

Zoning Categorization	Total Suspended Solids Concentration (mg/L) ^a		
	LCL	UCL	Mean
<ul style="list-style-type: none"> • Parcels zoned as SFR or MFR • Non-arterial streets adjacent to properties zoned as SFR or MFR 	44	93	69
<ul style="list-style-type: none"> • Parcels zoned as neighborhood/commercial, downtown, major institutions, master planned community, or residential/commercial • Arterial streets with adjacent property zoned as neighborhood/commercial, downtown, major institutions, master planned community, or residential/commercial 	58	106	82

Table 3.5 (continued). Zoning Categorization and TSS Characteristics.

Zoning Categorization	Total Suspended Solids Concentration (mg/L) ^a		
	LCL	UCL	Mean
<ul style="list-style-type: none"> • Parcels zoned as manufacturing/industrial • Non-arterial or arterial streets with adjacent property zoned as manufacturing/industrial 	58	177	118

^a Reference: SPU 2015.

LCL = lower confidence limit

UCL = upper confidence limit

SFR = Single-family Residential

MFR = [MultifamilyMulti-Family](#) Residential

Step 2: Select an Oil Control BMP if Oil Control is Required

If oil control is required (refer to *Volume 1, Section 5.4.2.1*), select an Oil Control BMP using the list in Figure 3.2 and the information in *Section 3.5.2.1*. Refer to the *General Design Requirements* in *Chapter 4* for additional requirements that may affect the design and placement of BMPs on the site (e.g., bypass). Refer to *Section 5.8.9* of this volume for design information.

Step 3: Select a Phosphorus Treatment BMP if Phosphorus Treatment is Required

At the time this manual was developed, there were no established phosphorus-specific treatment requirements for project-scale treatment BMPs in Seattle. However, if phosphorus treatment is required (refer to *Volume 1, Section 5.4.2.2*), select a Phosphorus Treatment BMP using the list in Figure 3.2 and the information in *Section 3.5.2.2* of this volume. If a project site is also subject to the enhanced treatment requirement, select a BMP or treatment train that is listed as providing both Enhanced Treatment and Phosphorus Treatment. Refer to the *General Design Requirements* in *Chapter 4* for additional requirements that may affect the design and placement of BMPs on the site (e.g., bypass). Refer to *Chapter 5* of this volume for BMP applicability, site considerations, and design criteria. Select water quality treatment BMPs that best integrate with the on-site stormwater management to the maximum extent feasible.

Step 4: Select an Enhanced Treatment BMP if Enhanced Treatment is Required

If enhanced treatment is required (refer to *Volume 1, Section 5.4.2.3*), select an Enhanced Treatment BMP using the list in Figure 3.2 and the information in *Section 3.5.2.3* of this volume. Determine whether infiltration is feasible (refer to *Section 3.2*). If infiltration is feasible, select an infiltration BMP (refer to Figure 3.2). Determine whether presettling or pretreatment is required (refer to *Section 4.4*). Select water quality treatment BMPs that best integrate with the on-site stormwater management to the maximum extent feasible.

If a project site is also subject to the phosphorus treatment requirement, select a BMP or treatment train that is listed as providing both Enhanced Treatment and Phosphorus Treatment. Refer to the *General Design Requirements* in *Chapter 4* for additional

requirements that may affect the design and placement of BMPs on the site. Refer to *Chapter 5* of this volume for BMP applicability, site considerations, and design criteria.

Step 5: Select a Basic Treatment BMP

If the Water Quality Treatment Minimum Requirement is triggered (refer to *Volume 1, Chapters 2 and 5*) and the criteria for Phosphorus Treatment and Enhanced Treatment do not apply (refer to *Volume 1, Section 5.4.2.2 and 5.4.2.3*), then only basic treatment is required. Determine whether infiltration is feasible (refer to *Section 3.2*). If infiltration is feasible, select an infiltration BMP (refer to *Figure 3.2*). Determine whether presettling or pretreatment is required (refer to *Section 4.4*). Select treatment BMPs that best integrate with the on-site stormwater management to the maximum extent feasible.

Select a Basic Treatment BMP using the list in *Figure 3.2* and the information in *Section 3.3.2.4*. Refer to the General Design Requirements in *Chapter 4* for additional requirements that may affect the design and placement of BMPs on the site. Refer to *Chapter 5* of this volume for BMP applicability, site considerations, and design criteria.

Step 6: Use Pre-sized or Modeling Sizing Approach for BMP Design

For projects with 10,000 square feet or more new and replaced hard surface area, use the Modeling Approach for BMP design (Step 6b). For sites with less than 10,000 square feet new and replaced hard surface area, use either the Pre-sized Approach or Modeling Approach for BMP design (Steps 6a or 6b).

Step 6a: Use Pre-sized Approach for BMP design

Apply the Pre-sized Approach for BMP design (refer to *Section 4.1.2*). The designer may also choose to use the Modeling Approach (refer to Step 6b).

Step 6b: Use Modeling Approach for BMP design

Apply the Modeling Approach for BMP design. Refer to *Section 4.1.3* and *Appendix F* for modeling guidelines.

BMPs should be sized using either the water quality design storm volume or flow rate on an annual average basis. The performance goal applies on an average annual basis to the entire annual discharge volume (treated plus bypassed). The incremental portion of runoff in excess of the water quality design flow rate or volume can be routed around the BMP (offline treatment facilities), or can be passed through the BMP (on-line treatment BMPs) provided a net pollutant reduction is maintained (refer to *Section 4.2*). Other contributing areas shall bypass the facility, or the facility shall be sized to accommodate the additional contributing area. Where feasible, offline facilities are required to prevent resuspension and washout of accumulated [sediment \(and associated metals and phosphorus\)](#) during large storm events.

Oil/water separators shall be located offline and bypass the incremental portion of flows that exceed the offline water quality design flow rate (refer to *Section 4.2.1*). If it is not possible to locate the separator offline (e.g., roadway intersections), use the on-line water quality design flow rate (refer to *Section 4.2.1*).

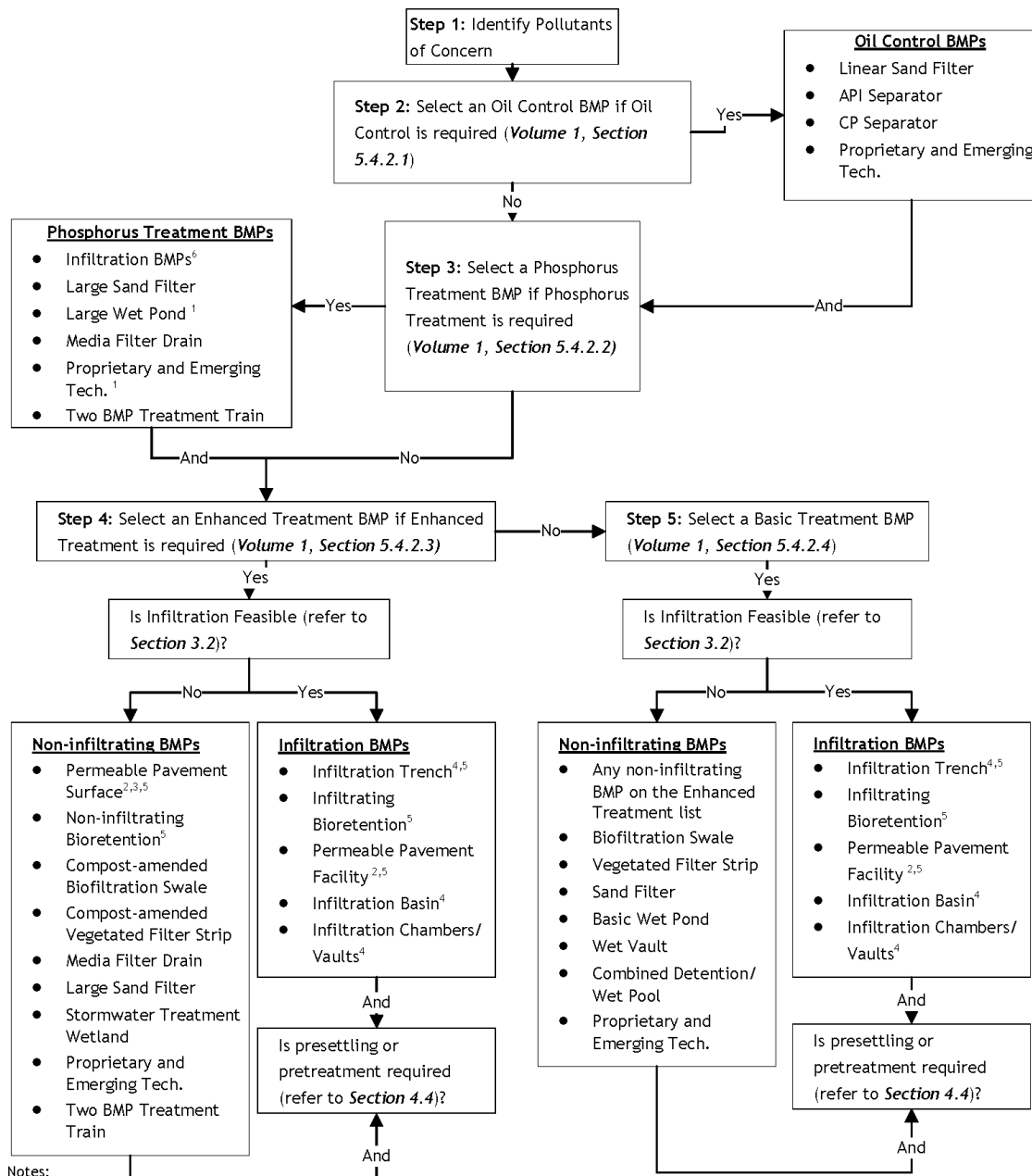

Notes:

- 1 - When Phosphorous Control and Enhanced Treatment are required, the Large Wet Pond and certain types of emerging technologies will not meet both types of treatment requirements. A different or an additional treatment BMP will be required to meet Enhanced Treatment.
- 2 - Underlying soil must meet the treatment soil requirements outlined in Section 4.5.2 or a water quality treatment course must be included per Section 5.4.6.5.
- 3 - Standard may be partially or completely achieved depending upon subgrade slope, infiltration rate of subgrade soil, and whether aggregate subbase is laid above or below surrounding grade.
- 4 - Soil suitability criteria (Section 4.5.2) and applicable drawdown requirements (Section 4.5.1) must be met.
- 5- BMP is on the On-site List (Volume 1, Section 5.2).
6. If the infiltration BMP is within ¼ mile of a phosphorus sensitive water (or tributary to that water), native soil must meet soil suitability criteria (Section 4.5.2) to be used to meet Phosphorus Treatment. If the infiltration BMP is a minimum of ¼ mile away, native soil does not have to meet the soil suitability criteria to be used to meet Phosphorus Treatment requirements if infiltration into the native soil is preceded by a Basic Treatment BMP.

Figure 3.2. Water Quality Treatment BMP Selection Flow Chart.

Mass-Based Sizing for Proprietary BMPs

The City requires proprietary technologies to be sized to account for solids loading targeting annual maintenance. To achieve this target, the City requires adjustment of the water quality design flow rate based upon mass loading ratios. Refer to *Section 5.8.11.6* to determine how to size proprietary BMPs using the mass-based sizing approach. When *Section 5.8.11.6* does not provide sizing guidance for a BMP of interest, refer to Table 3.5 and provide documentation from the manufacturer that the annual maintenance target has been met.

3.5.2. Treatment Performance Goals and BMP Options

This section identifies choices that meet the treatment BMP categories referred to in *Section 3.5.1*. The treatment BMP categories in this section are discussed in the order of the decision process outlined in Figure 3.2 and include the following:

- Oil Control Treatment, *Section 3.5.2.1*
- Phosphorus Treatment, *Section 3.5.2.2*
- Enhanced Treatment, *Section [3.5.2.3](#)*
- Basic Treatment, *Section 3.5.2.4*

3.5.2.1. Oil Control Treatment

Performance Goal – Oil Control Treatment BMPs are designed to achieve the following:

- No ongoing or recurring visible sheen
- A 24-hour average Total Petroleum Hydrocarbon (TPH) concentration no greater than 10 mg/l
- A maximum of 15 mg/l for a discrete sample (grab sample)

Note: For the analysis of [grab samples for](#) most petroleum products, use the NWTPH-Dx method ~~in Ecology Publication No. ECY 97-602, Analytical Methods for Petroleum Hydrocarbons~~. If the concentration of gasoline is of interest, use the NWTPH-Gx method to analyze grab samples.

BMP Options – Any one of the following options may be selected to satisfy the oil control requirement:

- Linear Sand Filter (refer to *Section [5.8.55-8-8](#)*)
- API-Type Oil/Water Separator (refer to *Section [5.8.105-8-12](#)*)
- Coalescing Plate Oil/Water Separator (refer to *Section [5.8.105-8-12](#)*)
- Proprietary and Emerging Water Quality Treatment Technologies (refer to *Section [5.8.115-8-14](#)*)

Note: The linear sand filter is also used for basic, enhanced, and phosphorus treatment. If used to satisfy one of those treatment requirements, do not use the same BMP to satisfy the oil control requirement. This increase in maintenance is to prevent clogging of the filter by oil so that it will function for suspended solids, metals, and phosphorus removal as well.

3.5.2.2. Phosphorus Treatment

Performance Goal – Phosphorus Treatment BMPs are designed to achieve 50 percent total phosphorus (TP) removal for a range of influent concentrations of 0.1 to 0.5 mg/l. In addition, the Phosphorus Treatment BMPs are designed to achieve Basic Treatment.

BMP Options – Any one of the following options may be selected to satisfy the Phosphorus Treatment requirement:

- Infiltration Trench – refer to *Section 5.4.2*
- Infiltrating Bioretention [\(without underdrain\)](#) – refer to *Section 5.4.4*
- Permeable Pavement Facility – refer to *Section 5.4.6*
- Infiltration Basin – refer to *Section 5.4.8*
- Infiltration Chamber/[Vault](#) – refer to *Section 5.4.9*
- Media Filter Drain – refer to *Section 5.8.4*
- Large Sand Filter – refer to *Section [5.8.55-8-8](#)*
- Large Wet Pond – refer to *Section [5.8.65-8-9](#)*
- Proprietary and Emerging Water Quality Treatment Technologies targeted for phosphorus removal – refer to *Section [5.8.115-8-14](#)*
- Two-BMP Treatment Trains – refer to Table 3.6

Table 3.6. Treatment Trains for Phosphorus Treatment.

First BMP	Second BMP
Biofiltration Swale (<i>Section 5.8.3</i>)	Basic Sand Filter or Sand Filter Vault (<i>Section 5.8.5</i>)
Vegetated Filter Strip (<i>Section 5.8.4</i>)	Linear Sand Filter (<i>Section 5.8.5</i>), no presettling needed
Linear Sand Filter (<i>Section 5.8.5</i>)	Vegetated Filter Strip (<i>Section 5.8.4</i>)
Basic Wet Pond (<i>Section 5.8.6</i>)	Basic Sand Filter or Sand Filter Vault (<i>Section 5.8.5</i>)
Wet Vault (<i>Section 5.8.7</i>)	Basic Sand Filter or Sand Filter Vault (<i>Section 5.8.5</i>)
Stormwater Treatment Wetland (<i>Section 5.8.8</i>)	Basic Sand Filter or Sand Filter Vault (<i>Section 5.8.5</i>)
Basic Combined Detention and Wet Pool (<i>Section 5.8.9</i>)	Basic Sand Filter or Sand Filter Vault (<i>Section 5.8.5</i>)
Basic Treatment BMP (Section 3.5.2.4)	BMP which infiltrates into native soil^a

^a [Either a\) native soil shall meet Soil Suitability Criteria \(Section 4.5.2\) or b\) infiltration shall be a minimum of 1/4 mile from phosphorus-sensitive water \(or tributary to that water\) and be preceded by a Basic Treatment BMP.](#)

3.5.2.3. Enhanced Treatment

Performance Goal – Enhanced Treatment BMPs without compost are designed to remove greater than 30 percent dissolved copper removal and greater than 60 percent dissolved zinc removal. The performance goal assumes that the Enhanced Treatment BMP is treating stormwater with dissolved copper typically ranging from 5 to 20 µg/l, and dissolved zinc ranging from 20 to 300 µg/l. In addition, the Enhanced Treatment BMPs are designed to achieve Basic Treatment.

BMP Options – Any one of the following options may be selected to satisfy the Enhanced Treatment requirement:

- Infiltration Trench – refer to *Section 5.4.2*
- Infiltrating Bioretention – refer to *Section 5.4.4*
- Permeable Pavement Facilities – refer to *Section 5.4.6*
- Infiltration Basin – refer to *Section 5.4.8*
- Infiltration Chamber/[Vault](#) – refer to *Section 5.4.9*
- Permeable Pavement Surfaces – refer to *Section 5.6.2*
- Non-infiltrating Bioretention – refer to *Section 5.8.2*
- Compost-amended Biofiltration Swale – refer to *Section 5.8.32*
- Compost-amended Vegetated Filter Strip (CAVFS) – refer to *Section 5.8.45-8-7*
- Media Filter Drain – refer to *Section 5.8.45-8-7*
- Large Sand Filter – refer to *Section 5.8.55-8-8*
- Stormwater Treatment Wetland – refer to *Section 5.8.85-8-11*
- Proprietary and Emerging Water Quality Treatment Technologies – refer to *Section 5.8.115-8-14*
- Two BMP Treatment Trains – refer to Table 3.7

Table 3.7. Treatment Trains for Enhanced Treatment.

First BMP	Second BMP
Biofiltration Swale (<i>Section 5.8.3</i>)	Basic Sand Filter, Sand Filter Vault, or an approved Proprietary and Emerging Water Quality Treatment Technology ^a (<i>Section 5.8.5</i> or <i>Section 5.8.11</i>)
Vegetated Filter Strip (<i>Section 5.8.4</i>)	Linear Sand Filter with no presettling cell needed (<i>Section 5.8.5</i>)
Linear Sand Filter (<i>Section 5.8.5</i>)	Vegetated Filter Strip (<i>Section 5.8.4</i>)
Basic Wet Pond (<i>Section 5.8.6</i>)	Basic Sand Filter, Sand Filter Vault, or an approved Proprietary and Emerging Water Quality Treatment Technology ^a (<i>Section 5.8.5</i> or <i>Section 5.8.11</i>)
Wet Vault (<i>Section 5.8.7</i>)	Basic Sand Filter, Sand Filter Vault, or an approved Proprietary and Emerging Water Quality Treatment Technology ^a (<i>Section 5.8.5</i> or <i>Section 5.8.11</i>)
Basic Combined Detention/Wet Pool (<i>Section 5.8.9</i>)	Basic Sand Filter, Sand Filter Vault, or an approved Proprietary and Emerging Water Quality Treatment Technology ^a (<i>Section 5.8.5</i> or <i>Section 5.8.11</i>)
Basic Sand Filter or Sand Filter Vault with a presettling cell if the filter is not preceded by a detention BMP (<i>Section 5.8.5</i>)	An approved Proprietary and Emerging Water Quality Treatment Technology ^a (<i>Section 5.8.5</i> or <i>Section 5.8.11</i>)

^a The media shall be of a type approved for basic or enhanced treatment use by Ecology and accepted by the Director.

3.5.2.4. *Basic Treatment*

Performance Goal – Basic Treatment BMPs are designed to achieve 80 percent removal of TSS for influent concentrations greater than 100 mg/l, but less than 200 mg/l. For influent concentrations greater than 200 mg/l, a higher treatment goal may be appropriate. For influent concentrations less than 100 mg/l, the BMPs are designed to achieve an effluent goal of 20 mg/l TSS.

BMP Options – Any one of the following options may be selected to satisfy the basic treatment requirement:

- Infiltration Trench – refer to *Section 5.4.2*
- Infiltrating Bioretention – refer to *Section 5.4.4*
- Permeable Pavement Facility – refer to *Section 5.4.6*
- Infiltration Basin – refer to *Section 5.4.8*
- Infiltration Chamber/[Vault](#) – refer to *Section 5.4.9*
- Permeable Pavement Surfaces – refer to *Section 5.6.2*
- Non-infiltrating Bioretention – refer to *Section 5.8.2*
- Biofiltration Swales – refer to *Section 5.8.3*
- [Vegetated](#)Basic Filter Strip – refer to *Section 5.8.4*
- Compost-amended Vegetated Filter Strip (CAVFS) – refer to *Section 5.8.4*
- Media Filter Drain – refer to *Section 5.8.4*
- Sand Filters – refer to *Section 5.8.5*
- Basic Wet Pond – refer to *Section 5.8.6*
- Wet Vault – refer to *Section 5.8.7*
- Stormwater Treatment Wetland – refer to *Section 5.8.8*
- Combined Detention and Wet Pool – refer to *Section 5.8.9*
- Proprietary and Emerging Water Quality Treatment Technologies – refer to *Section 5.8.11*

CHAPTER 4 – GENERAL DESIGN REQUIREMENTS

This chapter describes general design requirements for the following:

- Sizing approach
- Bypass, [flow-through, and off-site flow](#)
- Conveyance
- [Presettling and pPretreatment requirements](#)
- Infiltration BMPs [requirements](#)

4.1. Sizing Approach

This section describes the sizing approach for the following:

- **On-site List Approach:** to meet the On-site Stormwater Management requirement
- **Pre-sized Approach:** flow control credits, BMP sizing factors, and BMP sizing equations to meet flow control or water quality treatment performance standards
- **Modeling Approach:** continuous modeling approach to meet the On-Site Performance Standard, a specific flow control standard, or a water quality treatment requirement

The minimum requirements based on project type are provided in *Volume 1, Chapter 4*.

4.1.1. *On-site List Approach*

Under the On-site List Approach, the On-site Stormwater Management Requirement may be met by selecting from a prioritized list of On-site BMPs as explained in *Section 3.3.1*. On-site List BMPs shall be sized as prescribed under the Sizing for On-site List Approach in each On-site BMP section in *Chapter 5*.

4.1.2. Pre-sized Approach

The Pre-sized Approach may be used to select and size a BMP to meet flow control and water quality treatment performance standards without performing continuous modeling when the following conditions have been met:

- The new and replaced hard surface area associated with a project does not exceed 10,000 square feet, and
- The project is subject to the Pre-developed Pasture Standard, the Peak Control Standard, and/or Water Quality Treatment Standard (Basic, Oil, Phosphorus, and Enhanced Treatment)

4.1.2.1. Pre-sized Facilities

The BMPs included in the Pre-sized Approach include the following:

BMP Category and Name	Type of Credit/Factor	Applicable Standards
Tree Planting and Retention	Flow Control Credit	Flow Control
Dispersion BMPs		
Downspout Dispersion	Flow Control Credit	Flow Control
Sheet Flow Dispersion	Flow Control Credit	Flow Control
Infiltration BMPs		
Infiltration Trenches	BMP Sizing Factor	Flow Control, Water Quality
Dry Wells	BMP Sizing Factor	Flow Control
Infiltrating Bioretention	BMP Sizing Factor	Flow Control, Water Quality
Permeable Pavement Facilities	BMP Sizing Factor	Flow Control, Water Quality
Infiltration Chambers	BMP Sizing Factor	Flow Control, Water Quality
Alternative Surface BMPs		
Vegetated Roof Systems	Flow Control Credit	Flow Control
Permeable Pavement Surfaces	Flow Control Credit	Flow Control
Detention BMPs		
Detention Pipes	BMP Sizing Equation	Flow Control
Detention Vaults	BMP Sizing Equation	Flow Control
Detention Cisterns (aboveground)	BMP Sizing Equation	Flow Control
Non-infiltrating BMPs		
Non-infiltrating Bioretention	BMP Sizing Factor	Flow Control, Water Quality

Specific design requirements for the pre-sized BMPs (e.g., side slopes, freeboard, aggregate thickness, soil depth) are provided in the *BMP Credit* or *BMP Sizing* sections in *Chapter 5*.

4.1.2.2. Pre-sized Credits, Sizing Factors, and Equations

The pre-sized BMPs are provided as either a flow control credit, BMP sizing factor, or BMP sizing equation. These are described below.

- **Flow Control Credits:** Flow control credits are awarded for BMPs that reduce hard surface areas. These credits can be applied to reduce the hard surface area requiring flow control. Note: This applies to flow control calculations only. If a site is also subject to water quality treatment requirements, calculations for water quality shall also be performed.

- **BMP Sizing Factors:** BMPs may be sized using the sizing factors provided in *Chapter 5*. The sizing factors can be used to calculate the BMP size as a function of the contributing area ([this includes undisturbed areas and off site areas draining to the BMP](#)). These sizing factors were developed using a continuous runoff hydrologic model to achieve applicable flow control and water quality treatment standards. For BMPs with variable allowable depths, sizing factors are provided for at least two typical depths. Designers may linearly interpolate BMP size for intermediate design depths, but may not extrapolate.
- **BMP Sizing Equations:** BMPs may be sized using the sizing equations provided in *Chapter 5*. Sizing equations were developed using a continuous runoff hydrologic model to achieve applicable flow control and water quality treatment standards.

For each BMP, flow control credits, sizing factors, or sizing equations were developed for typical design variations (e.g., ponding depths, aggregate thickness, slopes, etc.). To use these BMPs with a different design configuration or BMPs not listed above, the designer shall use the Modeling Approach (refer to *Section 4.1.3*).

When using the pre-sized sizing factors or sizing equations for water quality treatment, stormwater flows from other areas (beyond the area for which the [BMPfacility](#) is sized) shall be bypassed around the [BMPfacility](#); or [BMPsfacilities](#) shall be sized to treat runoff from the entire area draining to the [BMPfacility](#), [even if some of those areas are not pollutant-generating](#).

When using the pre-sized sizing factors or sizing equations for flow control, it is preferred that flow control [BMPsfacilities](#) be sized for the entire area draining to the [BMPfacility](#). Additional flows may pass through a [BMPfacility](#) pre-sized to meet a flow control standard with the following limitations:

- The maximum additional area (i.e., area beyond the area for which the [BMPfacility](#) is pre-sized) that passes through a pre-sized BMP shall not exceed twice the area for which it is pre-sized.
- No flow control credit is given for runoff from any area in excess of the area for which the [BMPfacility](#) was pre-sized.
- If additional area is routed to a [BMPfacility](#), it shall be clearly noted on submitted plans.
- The overflow infrastructure shall be sized for the full contributing area (refer to *Section 4.3.3*).
- Projects shall still meet the flow control standards at the point of compliance.

BMP sizing factors and equations were developed for Pre-developed Pasture and Peak Control Standards. If both standards apply to a project (such as a site in a non-listed creek basin with a capacity constrained drainage system), the larger BMP size or conservative flow control credit shall be used. A Pre-sized Approach was not developed for the Pre-developed Forested Standard because it is not triggered as often as the other flow control standards.

Generalized assumptions were used to design the pre-sized BMPs that may result in conservative sizing or may underestimate flow control or treatment credits for some sites. Refer to the *BMP Credit* or *BMP Sizing* sections each BMP section in *Chapter 5* for modeling

assumptions used in the Pre-sized Approach. Designers have the option to use the pre-sized BMPs provided in this section, or to follow the Modeling Approach (refer to *Section 4.1.3*) and submit an alternative BMP size with supporting engineering calculations for review and consideration.

4.1.2.3. Pre-sized Calculator

The City has also prepared a spreadsheet tool (An Excel-based Pre-sized Flow Control Calculator) to help users document and implement the flow control BMP selection process for small sites (<10,000 square feet of new and replaced hard surface area). Refer to ~~is provided on the~~ SDCI's Stormwater Code web page ~~website~~ to download the latest version of the spreadsheet tool: ~~(~~[www.seattle.gov/sdci/codes/codes-we-enforce-\(a-z\)/stormwater-code](http://www.seattle.gov/sdci/codes/codes-we-enforce-(a-z)/stormwater-code)~~)~~www.seattle.gov/dpd/codesrules/codes/stormwater~~.~~ This spreadsheet tool/calculator automates sizing calculations (i.e., the flow control credits, BMP sizing factors and BMP sizing equations described above) and guides the applicant through the process of selecting BMPs. This calculator may be provided as part of a plan submittal to document compliance with flow control and/or water quality treatment standards.

4.1.3. Modeling Approach

Unless otherwise specified, all continuous modeling shall be performed using the City of Seattle Design Time Series (consisting of a 158-year precipitation and evaporation time series that ~~is are~~ representative of the climatic conditions in the City of Seattle) and a 5-minute computational time step (refer to Table F.12 in Appendix F, Section F-4 for correct time step). At the time of publication of the 2021 Seattle Stormwater Manual, the approval of MGSFlood is limited and was not approved for modeling bioretention (infiltrating or non-infiltrating) by Ecology. Refer to the Approval Status of Continuous Simulation Models section of the SWMMWW for a list of currently approved models and limitations.

Drainage basins for both disturbed and undisturbed areas shall be clearly noted on submitted plans. Any off-site areas that are topographically tributary or have piped connections shall be shown on drainage basin maps. Modeling shall extend to the approved point of discharge or to the limits of a downstream capacity analysis.

Note that soils that are amended using options 2, 3, or 4 as described in Section 5.1.6 may be modeled as pasture land use.

Continuous simulation methods and a list of approved continuous runoff hydrologic simulation models are provided in Appendix F.

4.1.3.1. On-site Performance Standard

As an alternative to the On-site List Approach (Section 4.1.1), the On-site Requirement can be met by demonstrating that the On-site Performance Standard (Volume 1, Section 5.2) is achieved. Under the Modeling Approach, BMPs are designed to achieve the On-site Performance Standard using a continuous ~~rainfall~~-runoff hydrologic model. Specific modeling requirements are presented in the *BMP Credit* or *BMP Sizing* section for each BMP in Chapter 5. For compliance with the On-site Performance Standard, it shall be demonstrated that the suite of BMPs used on the site results in the standard being met at the discharge point (also known as the point of discharge).

4.1.3.2. Flow Control

The Modeling Approach may be used for any project to design flow control BMPs, and is required for the following scenarios:

- Projects with new and replaced hard surface area equal to or exceeding 10,000 square feet that trigger a flow control standard
- Projects with new and replaced hard surface area less than 10,000 square feet that are proposing to use different BMPs and/or assumptions than those used in the Pre-sized Approach

Under the Modeling Approach, flow control BMPs are designed to achieve flow control standards using a continuous ~~rainfall~~-runoff hydrologic model refer to (refer to Volume 1, Section 5.3). Specific modeling requirements are presented in the *BMP Sizing* or *BMP Credits* section for each BMP in Chapter 5. For detention BMPs the minimum bottom orifice diameter will be too large to meet standard release rates in some scenarios, even with minimal head.

Designers should iteratively increase detention area and decrease live storage depth until the performance criteria are met. However, live storage depth need not be reduced to less than 3 feet in an attempt to meet the flow control standards. Typically, flow control standards can be achieved using a 0.5-inch-diameter bottom orifice with a 3-foot live storage depth in the following scenarios:

- Pre-developed Forested Standard can be achieved when the contributing impervious area is greater than approximately 45,000 square feet.
- Pre-developed Pasture Standard can be achieved when the contributing impervious area is greater than approximately 19,000 square feet.
- Peak Control Standard can be achieved when the contributing impervious area is greater than approximately 2,000 square feet.

For smaller contributing impervious areas, the following design/modeling approach is recommended:

- *Step 1* – Size the detention facility with 3 feet or less of head to meet the flow control standard with an optimized orifice size (orifice diameter may be lower than minimum allowed for construction).
- *Step 2* – Use the facility size (e.g., length and diameter) obtained in Step 1 and increase the orifice diameter to the minimum size (0.5 inch).

The BMPs used to meet the On-site List or the On-site Performance Standard may be included in the model and may contribute towards meeting the flow control standard(s), if applicable. When using the Modeling Approach, it shall be demonstrated that the suite of BMPs used on the site results in the standard(s) being met at the point of discharge.

4.1.3.3. Water Quality Treatment

The Modeling Approach may be used for any project to design water quality treatment BMPs, and is required for the following scenarios:

- Projects with new and replaced hard surface area equal to or exceeding 10,000 square feet that trigger Basic or Enhanced Treatment
- Projects that trigger Phosphorus or Oil Treatment
- Projects with new and replaced hard surface area less than 10,000 square feet that are proposing to use different BMPs and/or assumptions than those used in the Pre-sized Approach

Under the Modeling Approach, water quality treatment BMPs are designed to treat a specific water quality design storm volume or flow rate (refer to *Volume 1, Section 5.4.1* and *Appendix F*) using a continuous [rainfall-runoff hydrologic](#) model. Specific modeling requirements are presented in the *BMP Sizing* section for each applicable BMP in *Chapter 5*. Some non-infiltrating BMPs (sand filters and oil/water separators) use a simplified sizing approach (refer to *Section 5.8.5 and 5.8.10*). The BMPs used to meet the On-site List or the On-site Performance Standard may be included in the model and may contribute towards meeting the Water Quality Treatment Standard, if applicable.

4.1.3.4. Wetland Hydroperiod Protection

There are two methods for calculating wetland hydroperiod protection:

- Method 1 – Monitoring and Wetland Stage Monitoring
- Method 2 – Site Discharge Modeling

Both methods involve continuous simulation modeling. Refer to Volume I, Appendix I-C of the 2019 SWMMWW for specific details on how to evaluate wetland hydroperiod protection using these methods.

Method 1 – Monitoring and Wetland Stage Monitoring

The following calculations should be included in the wetland hydroperiod evaluation using Method 1:

- Existing water level fluctuation (WLF) based on monitored water levels
 - Mean annual
 - Mean monthly
- Estimated daily, monthly, or annual WLF based on continuous simulation modeling
- Allowable WLF change (compare with estimated WLF to verify compliance)

Method 2 – Site Discharge Monitoring

The following calculations should be included in the wetland hydroperiod evaluation using Method 2:

- Daily discharge volumes based on continuous simulation modeling
- Monthly discharge volumes based on continuous simulation modeling

4.1.3.5. Closed Depressions

The analysis of closed depressions requires careful assessment of the existing hydrologic performance in order to evaluate the impacts a proposed project will have. The applicable requirements should be thoroughly reviewed prior to proceeding with the analysis. Closed depressions generally facilitate infiltration of runoff. If a closed depression is classified as a wetland, then Minimum Requirement #8 applies (refer to Volume 1, Section 3.5). A continuous runoff hydrologic model shall be used for closed depression analysis and design of mitigation facilities. If a closed depression is not classified as a wetland, model the ponding area at the bottom of the closed depression as an infiltration pond using an approved continuous runoff hydrologic model.

4.2. Bypass, Flow-Through, and Off-Site Flow General Design Requirements

4.2.1. ~~On-line vs. Offline Treatment BMPs~~ On-line vs. Offline

Treatment BMPs shall be designed to treat runoff from the entire area (disturbed and undisturbed, hard surface and pervious surface, pollution-generating and non-pollution generating, on-site and off-site) draining to it. Flows from off-site and runoff from non-pollution generating areas on-site that can be kept separate may be bypassed around the treatment BMP to reduce its required size.

Treatment BMPs located upstream of a detention system can be designed as on-line or offline BMPs.

- On-line BMPs:** On-line BMPs receive all of the stormwater runoff from the contributing area and do not include flow splitters. The on-line water quality design flow rate (as determined by a continuous runoff hydrologic model) is used to size on-line BMPs. On-line BMPs treat flows up to the on-line water quality design flow rate to meet the performance goal, and flows higher than the on-line water quality design flow rate pass through the BMP at a lower percent removal. Runoff flow rates in excess of the water quality design flow rate can be routed through the BMP provided a net pollutant reduction is maintained, and the applicable annual average performance goal is designed to be met and velocities are not high enough to resuspend sediments. Designers shall ensure that the higher flows will not damage the BMPs. If higher flows will damage the proposed BMP, the flows to the BMP shall be attenuated or an off-line BMP shall be used.
- Offline BMPs:** Off-line BMPs make use of a flow splitter directly upstream of the BMP to regulate the amount of flow entering the BMP. The flow splitter shall be designed to direct flows up to and including the offline water quality design flow rate (as determined by a continuous runoff hydrologic model) to the BMP. The BMP shall be sized to treat the offline water quality design flow rate. For non-infiltrating BMPs not preceded by an equalization or storage basin, flows exceeding the water quality design flow rate may be bypassed around (internal bypass is generally not acceptable) the treatment BMP. ~~Where feasible, o~~Offline facilities are required to prevent resuspension and washout of accumulated sediment (and associated metals and phosphorus) during large storm events (*Section 3.5*). However, during bypass events, the BMP facility will continue to receive and treat the water quality design flow rate. Only the higher incremental portion of flow rates are bypassed around a treatment BMP. Design guidelines for flow splitters for use in offline BMPs are provided in *Appendix E-2*.

Non-infiltrating BMPs ~~preceded by~~ located downstream of an equalization or storage basin may identify a lower water quality design flow rate provided that at least 91 percent of the total runoff volume predicted by an approved continuous runoff hydrologic model is treated to the applicable performance goals (e.g., 80 percent total suspended solids (TSS) removal at the water quality design flow rate and 80 percent TSS removal on an annual average basis).

4.2.2. *Bypassing Flows Entering ~~or Leaving~~ a Site*

The following ~~three flow~~ bypass-related scenarios ~~require~~ recognize that additional considerations be taken into account when designing BMPs when off-site flows enter a project site. ~~(refer to also Appendix E for design guidelines for flow splitters):~~

1. Flow currently enters the project site, but can be bypassed as part of the proposed project improvements.
2. Flow currently enters the project site, but cannot be bypassed as part of the proposed project improvements.
- ~~3. Flow that is within the project limits cannot feasibly be routed to the project BMP.~~

The requirements and guidelines applicable to each scenario are outlined below.

4.2.2.1. *Scenario 1 – ~~Managing Bypassing Flows Entering a Site~~*

Off-site fFlows may bypass ~~flow control~~ BMPs if all of the following conditions are met:

- Natural drainage courses are maintained
- Existing flows to wetlands are maintained (refer to *Volume 1, Section 5.3.1*)
- Off-site flows that are naturally attenuated by the project site under predeveloped conditions ~~must~~ shall remain attenuated, either by natural means or by providing additional on-site detention to mimic the attenuated condition and so that peak flows or discharge rates and duration do not increase.
- The point of discharge does not adversely impact down gradient properties

Refer to Appendix E-2 for design guidelines for flow splitters.

4.2.2.2. *Scenario 2 – ~~Managing Flows Entering a Site~~Flow-Through a Flow Control BMP*

It is preferred that flow control ~~BMPs~~ facilities be sized for the entire area draining to the ~~BMP~~ facility. It is required that treatment BMPs be sized for the entire area draining to the BMP.

Additional flows may pass through a ~~BMP~~ facility sized to meet a flow control standard with the following limitations:

- ~~The maximum additional area (i.e., area beyond the area for which the facility is pre-sized) that may pass through a BMP shall not exceed twice the area for which it is sized.~~ Projects shall still meet the flow control standard at the point of compliance where the flow control standard is evaluated.
- ~~No flow control credit is given for runoff from any area in excess of the area for which the facility was sized.~~
- If additional area is routed to a BMP, it shall be clearly noted on submitted plans and drainage basin maps.
- The overflow infrastructure shall be sized for the full contributing area (refer to *Section 4.3.3*).

- If the flow control BMP was sized using the modeling approach (refer to Section 4.1.3), ~~if and~~ the existing 100-year peak flow rate from any upstream off-site area is greater than 50 percent of the 100-year developed peak flow rate (undetained) for the project site, then the runoff from the off-site area ~~must-shall~~ not flow to the flow control BMP facility.
- If the flow control BMP was sized using the pre-sized approach (refer to Section 4.1.2) the entire area draining to the facility shall not be greater than twice the area for which it is sized.
- Projects shall still meet the flow control standards at the point of compliance. No flow control credit is given for runoff from any area in excess of the area for which the facility was sized.

4.2.3. Bypassing Flows Leaving a Site

At times it is not practical to collect all flows from a project site. All bypass areas shall be clearly noted on the submitted plans when bypass of a BMP is proposed. The following bypass-related scenarios recognize that additional considerations be taken into account when it is not feasible to collect runoff from a portion of the site.

1. A flow control BMP is designed to compensate for uncontrolled bypass flows.
2. A flow control BMP cannot be designed to collect or compensate for a small bypass area.

In either scenario, the bypass drainage that is not feasible to be collected shall sheet flow from the site. No concentrated drainage may flow from the site unless it is in a conveyance system directed to an approved point of discharge. Also, in no case will drainage from more than 750 square feet of impervious area at a driveway and no more than a 10-foot width of impervious area abutting a public sidewalk, measured perpendicular to the public sidewalk, be permitted to drain across a public sidewalk.

4.2.2.3.4.2.3.1. Scenario 13 - Uncontrolled Flows Leaving the Site Compensate for Uncontrolled Bypass

Design of a flow control BMP can compensate for uncontrolled bypass if all of the following conditions are met:

- The flow control BMP is sized using the modeling approach to overdetermine flow to compensate for the uncontrolled bypass (refer to Section 4.1.3).
- The modeling documents that the flow control standard is met at the point of compliance, where flow control standards are evaluated and the controlled and uncontrolled flow join.
- When the bypass will not create significant adverse impacts to down gradient properties

Runoff from a project that cannot feasibly be routed to the proposed flow control BMP may be bypassed under one of the following conditions:

- When the proposed flow control BMP are designed to manage uncontrolled flow and meet the applicable minimum requirements for the project

- ~~When the bypass area is due to incidental grading to match surrounding roadways or properties, and is less than 1,000 square feet and will not create significant adverse impacts to down gradient properties~~

4.2.3.2. Scenario 2 – Uncontrolled Flows Leaving the Site

It is typically feasible to compensate for uncontrolled flows with a flow control BMP as described in Scenario 1. In the rare case when it is not feasible to compensate for uncontrolled flows leaving the site, runoff may be bypassed and not compensated if all of the following conditions are met:

- When the bypass area is due to incidental grading to match surrounding roadways or properties.
- When the bypass area is less than 1,000 square feet.
- When the bypass will not create significant adverse impacts to down gradient properties

4.3. Conveyance and Overflow General Design Requirements

4.3.1. *Conveyance Design and Capacity Analysis*

For design or capacity analysis of the public drainage system, early consultation with Seattle Public Utilities is recommended. ~~Client Assistance Memo (CAM) 1180 describes~~ Design ~~Guidelines~~ Requirements for Public ~~Storm Drain Facilities~~ Drainage Systems are described in the Public Drainage System Requirements Director's Rule on SPU's Policy and Director's Rules web page: <http://www.seattle.gov/utilities/about/policies>. Requirements and recommendations for Hydrologic Analysis and Design are in *Appendix F*. Requirements for service drains and side sewers are described in the Side Sewer Directors' Rule [on SDCI's Side Sewer Code web page: www.seattle.gov/sdci/codes/codes-we-enforce-\(a-z\)/side-sewer-code](http://www.seattle.gov/sdci/codes/codes-we-enforce-(a-z)/side-sewer-code).

~~4.3.2. *Approved Point of Discharge*~~

~~All projects shall convey stormwater flow to an approved point of discharge and include overflows for all stormwater BMPs.~~

~~The approved point of discharge as determined by the Director, in order of priority, includes:~~

- ~~● Surface waters~~
- ~~● Public storm drain pipes~~
- ~~● Ditch and culvert system~~
- ~~● Public combined sewer pipes~~
- ~~● Infiltration on site~~

~~4.3.3.~~ 4.3.2. *Requirements for Projects with No Off-site Point of Discharge*

~~Refer to Volume 1, Section 2.3 to determine the approved point of discharge.~~ Where it has been determined by the Director that there is no off-site point of discharge for the project, the following minimum design criteria shall be met:

- The drainage control plan shall be prepared by a licensed civil engineer;
- Infiltration ~~shall be~~ feasible per *Section 3.2*, or ~~as recommended~~ infiltration is [determined to be feasible as documented](#) in a stamped and signed report from a licensed professional [and approved by the Director](#);
- In addition to meeting other minimum requirements for the project, the infiltration BMP shall be designed to infiltrate the runoff volume from the area of development for the storm event with a 4 percent annual probability (25-year recurrence interval flow); and
- Infiltration BMPs shall be sized so that overflows do not exceed 0.0001 cfs during the peak flow with a 4 percent annual probability (25-year recurrence flow).

- [Identify the overland flowpath for flows that will exceed the capacity of the infiltration BMP. Prevent the flows from causing erosion or flooding on site or on adjacent properties \(refer to *Section 4.3.3*\). If the flows will be directed towards an offsite building, structure or ECA Steep Slope or Landslide Prone area, then the infiltration BMPs shall be designed to fully infiltrate all flows for the full, required simulation period in the continuous runoff model \(i.e., 100 percent infiltration\).](#)
- [Overland flow path shall be vegetated and a minimum of 10 feet long between BMP and any property line \(excluding right-of-way line\).](#)
- [If the project site is within the setback from an ECA Steep Slope or Landslide Prone area where infiltration is limited a slope stability analysis is required per the Site Constraint section in *Section 3.2*.](#)
- [Alternatively, if it is demonstrated that infiltration is not feasible as indicated above, all new and replaced hard surfaces shall be dispersed using Dispersion BMPs from *Section 5.3*.](#)

Note that the Simple Infiltration Test is not allowed for projects with no off-site point of discharge. These projects shall use a Small PIT to determine the measured infiltration rate (Refer to *Appendix D*).

One option for a small project with no approved off-site point of discharge consists of an infiltration BMP (i.e., infiltration trench, drywell or infiltration chamber/vault) situated downstream of a bioretention cell or a permeable pavement facility sized to infiltrate storms up to the conveyance standard (25-year recurrence interval flow). Refer to *Appendix E, Section E-10* for dry well sizing provided for this scenario.

Infiltration testing and plan preparation clarification for detached accessory dwelling units (DADUs) and additions with less than 1,500 sf of new plus replaced hard surface on lots with no off-site point of discharge:

- The applicant is allowed to perform the infiltration testing unless [the project site is within the setback from an ECA Steep Slope or Landslide Prone area where infiltration is limited \(refer to the Site Constraints in *Section 3.2*\) or unless testing by a licensed professional is otherwise determined to be required](#) by the Director.
- If the applicant chooses (in lieu of a licensed professional) to conduct the infiltration testing, the applicant shall conduct the Small PIT (rather than the Simple Infiltration Test).
- The test shall be documented with the Pilot Infiltration Test Checklist and a minimum 0.25-3 in/hr measured soil infiltration rate ~~must~~ shall be demonstrated.
- Drywells shall be sized, at a minimum, per *Appendix E, Section E-10—Drywell Sizing Tables (as modified July 22, 2016, in the Clarification Sheet for the Seattle Stormwater Manual)*.
- The applicant is allowed to prepare the drainage control plan unless otherwise determined by the Director.

~~4.3.4. Conveyance Systems to Point of Discharge~~

~~The types of conveyance systems to the approved point of discharge, in order of priority, includes:~~

- ~~— Direct pipe connections~~
- ~~— Ditch and culvert system~~
- ~~— Gutter or street flow line~~
- ~~— Surface dispersal~~

~~4.3.5.~~4.3.3. *BMP and Conveyance Overflow Requirements*

Overflows are critical to minimize flooding and protect properties, the downstream conveyance system, and receiving waters.

~~BMP o~~ Overflow options to an approved point of discharge (refer to *Section 4.3.2*) include the following:

- Direct conveyance
- Through a downstream BMP
- Through interflow to the surface
- To surface discharge
- Combination of these measures

Overflow conveyance options include the following:

- Piped
- Daylighted through a storage reservoir
- Distributed through a flow spreader (refer to *Appendix E*)
- Discharged through overtopping of the BMP

Plan shall include a site map that indicates all flow paths through pipes and surface topography. Consider overflows that may result from:

- Larger storms
- Failure of infiltration capacity for infiltrative BMPs
- BMP failure due to defects or problems (refer to *Appendix G*)
- Pump or electrical failures for pumped systems

Overflow requirements specific to the right-of-way include:

- Contain overflows within the roadway and direct to the drainage system or public combined sewer.
- Overflow paths shall not be over sidewalks.
- Overflow paths shall not be to private property, except as approved by the Director.

At a minimum, overflows shall be designed to convey peak flows with a 4 percent annual probability (25-year recurrence interval flows). During large storm events, capacity will be limited at the approved point of discharge and backwater calculations and installation of backwater protection may be required.

~~For dispersion BMPs and for infiltration BMPs designed to fully infiltrate all flows for the 158-year simulation period, a constructed overflow is not required. Plans shall indicate surface flow paths in case of failure of the BMP.~~

4.4. Presettling and Pretreatment Requirements

Presettling and pretreatment should be evaluated for most BMPs to protect BMPs from excessive siltation and debris. Pretreatment is required for some water quality treatment BMPs. Refer to the individual BMP sections in Chapter 5 for presettling and pretreatment requirements specific to those BMPs.

4.4.1. Description

Presettling and pretreatment are essential to effective long-term BMP performance.

- **Presettling:** Presettling consists of structures or cells. Presettling structures are catch basins or vaults that are located upstream of a BMP and are intended to collect sediment that could otherwise clog or impair the function of the primary BMP. Presettling structures protect facilities from excessive siltation and debris through settling to remove TSS prior to discharging to the primary BMP. Other types of presettling facilities (i.e., presettling cells, presettling zones) specific to BMPs are described in the BMP Design Criteria in *Chapter 5*.
- **Pretreatment:** Pretreatment consists of structures that are used to remove sediments, floating oils and floating debris (such as trash) upstream of a water quality treatment BMP to reduce clogging of the BMP.
 - Hydrodynamic separators: Flow-through structures with a settling or separation unit to remove sediments and particle-bound pollutants. The BMP name refers to the application of the energy of flowing water to facilitate sediment separation and removal. Depending on the type of unit, particle settling may occur by means of swirl action or indirect filtration.
 - Floatables capture: Facilities designed to trap floating oils and debris before it enters a primary treatment BMP. These facilities take advantage of the floating properties of certain pollutants, such as oils and trash, and capture them where they can be easily removed, sending the rest of the stormwater to a separate area for further treatment.

4.4.2. Performance Mechanisms

Where the primary performance mechanism of a treatment BMP is biofiltration, infiltration, filtration, or settling; excessive sediment can reduce the effectiveness over time by reducing stormwater contact with vegetation or clogging sands and other filtration media.

4.4.3. Applicability

4.4.3.1. Presettling and Pretreatment

Presettling should be evaluated for most BMPs to protect BMPs from excessive siltation and debris. Pretreatment may be required to remove TSS for infiltration and filtration BMPs and can be used as an alternative to presettling structures or cells. Refer to the individual BMP sections in Chapter 5 for presettling and pretreatment requirements specific to those BMPs. Pretreatment should also be considered where the basic treatment BMP or the receiving water may be adversely affected by non-targeted pollutants (e.g., oil), or may by

overwhelmed by a heavy load of targeted pollutants (e.g., suspended solids). General requirements for presettling and pretreatment are summarized in Table 4.1.

Table 4.1. Presettling and Pretreatment Requirements.

BMP	Presettling Cell or Structure	Alternative Pretreatment	Reference
Infiltration Trenches	S	Basic Treatment BMP or Proprietary and Emerging Water Quality Treatment Technologies ^a	<i>Section 5.4.2</i>
Drywells	A	Basic Treatment BMP or Proprietary and Emerging Water Quality Treatment Technologies ^a	<i>Section 5.4.3</i>
Infiltrating Bioretention	S	Basic Treatment BMP or Proprietary and Emerging Water Quality Treatment Technologies Emerging Technology ^a	<i>Section 5.4.4</i>
Rain Gardens	N	Not applicable	<i>Section 5.4.5</i>
Permeable Pavement Facilities	S	Basic Treatment BMP or Proprietary and Emerging Water Quality Treatment Technologies ^a	<i>Section 5.4.6</i>
Permeable Pavement Facility/Infiltration Chamber combination	S	Basic Treatment BMP or Proprietary and Emerging Water Quality Treatment Technologies ^a	Section 5.4.6
Perforated Stub-out Connections	S	Not applicable	<i>Section 5.4.7</i>
Infiltration Basins	S	Basic Treatment BMP or Proprietary and Emerging Water Quality Treatment Technologies ^a	<i>Section 5.4.8</i>
Infiltration Chambers/ Vaults	S	Basic Treatment BMP or Proprietary and Emerging Water Quality Treatment Technologies ^a	<i>Section 5.4.9</i>
Permeable Pavement Surfaces	N	Not applicable	<i>Section 5.6.2</i>
Non-infiltrating Bioretention	S	Basic Treatment BMP or Proprietary and Emerging Water Quality Treatment Technologies ^a	<i>Section 5.8.2</i>
Detention Ponds	A	Basic Treatment BMP or Proprietary and Emerging Water Quality Treatment Technologies ^a	<i>Section 5.7.1</i>
Detention Pipes	S	Not applicable	<i>Section 5.7.2</i>
Detention Vaults	S	Not applicable	<i>Section 5.7.3</i>
Detention Chambers	S	Basic Treatment BMP or Proprietary and Emerging Water Quality Treatment Technologies ^a	Section 5.7.3
Detention Cisterns	N	Not applicable	<i>Section 5.7.4</i>

Table 4.1 (continued). Presettling and Pretreatment Requirements.

BMP	Presettling Cell or Structure	Alternative Pretreatment	Reference
Basic Biofiltration Swale	S	Basic Treatment BMP or Proprietary and Emerging Water Quality Treatment Technologies ^a	Section 5.8.3
Wet Biofiltration Swale	S	Basic Treatment BMP or Proprietary and Emerging Water Quality Treatment Technologies ^a	Section 5.8.3
Compost-amended Biofiltration Swale	S	Basic Treatment BMP or Proprietary and Emerging Water Quality Treatment Technologies ^a	Section 5.8.3
Continuous Inflow Biofiltration Swale	N	Not applicable	Section 5.8.3
Basic Sand Filter Basin	A	Treatment Train	Section 5.8.5
Large Sand Filter Basin	A	Treatment Train	Section 5.8.5
Sand Filter Vaults	A	Treatment Train	Section 5.8.5
Linear Sand Filters	S	Treatment Train	Section 5.8.5
Basic Wet Pond	A	Treatment Train	Section 5.8.6
Large Wet Pond	A	Treatment Train	Section 5.8.6
Wet Vaults	A	Treatment Train	Section 5.8.7
Stormwater Treatment Wetlands	A	Treatment Train	Section 5.8.8
Combined Detention and Wet Pond	A	Treatment Train	Section 5.8.9
Combined Detention and Wet Vault	A	Treatment Train	Section 5.8.9
Combined Detention and Stormwater Wetland	A	Treatment Train	Section 5.8.9
American Petroleum Institute (API baffle type) Oil/water Separator	S	Basic Treatment BMP or Proprietary and Emerging Water Quality Treatment Technologies ^a	Section 5.8.10
Coalescing plate (CP) Oil/water Separator	S	Basic Treatment BMP or Proprietary and Emerging Water Quality Treatment Technologies ^a	Section 5.8.10
Proprietary and Emerging Water Quality Treatment Technology	S	Basic Treatment BMP or Proprietary and Emerging Water Quality Treatment Technologies ^a	Section 5.8.11

S – Sometimes

A – Always

N – Not Required

^a Refer to Section 5.8.11 for more information on approved stormwater technologies and technologies currently under review for pretreatment.

~~Pretreatment should also be considered where the basic treatment BMP or the receiving water may be adversely affected by non-targeted pollutants (e.g., oil), or may be overwhelmed by a heavy load of targeted pollutants (e.g., suspended solids).~~

4.4.3.2. Pretreatment

Specific pretreatment requirements for enhanced and phosphorus treatment are summarized in the following subsections.

Enhanced Treatment

~~In addition to the requirements for presettling and pretreatment summarized in Table 4.1, infiltration through soils that meet the minimum soil suitability criteria for water quality treatment (refer to Section 4.5.2) are considered enhanced treatment if preceded by a presettling cell or Basic Treatment BMP, except where presettling is not required due to the size of the contributing basin. Refer to the design criteria for the specific BMP for further information about presettling requirements. The following treatment trains can provide enhanced treatment:~~

~~Infiltration BMP preceded by a presettling cell or Basic Treatment BMP:~~

~~If infiltration is through soils meeting the minimum criteria for water quality treatment (refer to Section 4.5.2), a presettling cell or a basic treatment BMP can serve for pretreatment.~~

~~Infiltration preceded by a Basic Treatment BMP:~~

~~If infiltration is through soils that do not meet the soil suitability criteria for water quality treatment (refer to Section 4.5.2), treatment shall be provided by a basic treatment BMP unless the soil and site fit the description in the next option below.~~

~~Infiltration preceded by an Enhanced Treatment BMP:~~

~~If the soils do not meet the soil suitability criteria for water quality treatment (refer to Section 4.5.2) and the infiltration site is within 1/4 mile of a fresh water designated for aquatic life use or that has an existing aquatic life use, treatment shall be provided by another treatment BMP option.~~

Note: Bioretention systems that are constructed using the soil mix specified in Section 5.4.4.5 will qualify as Enhanced Treatment.

Phosphorus Treatment

~~In addition to the requirements for presettling and pretreatment summarized in Table 4.1, the following combinations treatment trains can also provide phosphorus treatment:~~

- ~~Infiltration BMP through soils that meet the minimum soil suitability criteria for water quality treatment (refer to Section 4.5.2) preceded by a presettling cell or Basic Treatment BMP, except where presettling is not required due to the size of the contributing basin. Refer to the design criteria for the specific BMP for further information about presettling requirements. :~~

~~If infiltration is through soils that meet the soil suitability criteria for water quality treatment (refer to Section 4.5.2), a presettling cell or a basic treatment BMP can serve for pretreatment.~~

- ~~Infiltration preceded by a Basic Treatment BMP through soils that do NOT meet the minimum soil suitability criteria for water quality treatment (refer to Section 4.5.2) if:~~
 - ~~It is preceded by a Basic Treatment BMP, AND~~
 - ~~There is a minimum distance of 1/4 mile between the infiltration location and the phosphorus sensitive receiving water (or tributary to that water).~~

~~If infiltration is through soils that do not meet the soil suitability criteria for water quality treatment (refer to Section 4.5.2), treatment shall be provided by a basic treatment BMP unless the soil and site fit the description in the next option below.~~

- ~~Infiltration preceded by a Phosphorus Treatment BMP:~~

~~If the infiltration soils do not meet the soil suitability criteria for water quality treatment (refer to Section 4.5.2) and the infiltration site is within 1/4 mile of a nutrient-critical receiving water, or a tributary to that water, treatment shall be provided by another a phosphorus treatment train BMP. At the time of publishing, the City has not have any designated any nutrient-critical receiving waters. In the event that any City nutrient-critical receiving waters are designated, the City will publish a Directors' Rule.~~

4.4.4. Site Considerations

Refer to *Chapter 5* for specific presettling requirements for some BMPs. Additional site considerations may apply depending on site conditions and other factors.

- Presettling:
 - For site considerations related to catch basins used as presettling structures, refer to City of Seattle Standard Plan No. 240, 241, or equivalent.
 - Refer to Site Considerations in *Chapter 5* for more information on presettling site consideration requirements specific to BMPs.
- Pretreatment:
 - Refer to manufacturer guidance for site considerations for hydrodynamic separators and floatables capture.

4.4.5. Design Criteria

Refer to *Chapter 5* for specific presettling requirements for some BMPs.

- Presettling:
 - Inflows shall be routed through a catch basin ~~or yard drain~~ with downturned elbow (trap) upstream of the BMP to capture sediment and reduce the potential for clogging. The minimum sump depth shall be 2 feet below outlet pipe.
 - Catch basins used for presettling shall be per City of Seattle Standard Plan No. 240, 241, or equivalent.

- Pretreatment:
 - Refer to manufacturer guidance for design criteria for hydrodynamic separators and floatables capture.
 - [Refer to BMP T6.10: Presettling Basin in the Volume V of the SWMMWW for specific design criteria and site constraints and setbacks including dam safety design and review requirements for impoundments that store greater than or equal to 10 acre-feet \(435,600 cubic feet or 3.26 million gallons\) above the natural ground level or have an embankment height of greater than 6 feet at the downstream toe.](#)

4.4.6. Operations and Maintenance Requirements

Presettling and pretreatment BMP operations and maintenance requirements are provided in *Appendix G* for Infiltration Facilities, Biofiltration Swales, Filter Strips, Wet Ponds, Stormwater Treatment Wetlands, Sand Filter Basins, and Sand Filter Vaults.

Refer to Ecology's website and the manufacturer for BMP-specific maintenance requirements for hydrodynamic separators (<https://ecology.wa.gov/Regulations-Permits/Guidance-technical-assistance/Stormwater-permittee-guidance-resources/Emerging-stormwater-treatment-technologies>www.ecy.wa.gov/programs/WQ/stormwater/newtech/technologies.html).

4.5. Infiltration BMPs

Infiltration BMPs have specific sizing guidelines and soil requirements that are summarized in the following subsections.

4.5.1. Infiltration BMP Sizing

Sizing for selected infiltration BMPs are provided in the BMP Sizing sections of *Chapter 5*. Below are the general procedures for sizing an infiltration BMP to: (A) infiltrate 100 percent of runoff; (B) meet the water quality treatment requirements; and (C) meet flow control standards. Infiltration BMPs shall be designed using an approved model.

- (A) For 100 percent infiltration (e.g., for project sites without a point of discharge):
- Input dimensions of the infiltration BMP into an approved model
 - Input design infiltration rate (measured infiltration rate with correction factor applied)
 - Input a riser height and diameter to represent the BMP overflow conditions (any flow through the riser indicates that you have less than 100 percent infiltration and shall increase the infiltration BMP dimensions)
 - Run the model and review the model-reported percentage of runoff infiltrated. If less than 100 percent infiltrated, increase BMP dimensions until 100 percent infiltration is achieved. There is no need to check duration when infiltrating 100 percent of the full continuous record runoff file.
- (B) For 91 percent infiltration (water quality treatment requirement):
- The procedure is the same as option A, except that the target is to infiltrate 91 percent of the influent runoff volume. In addition, to prevent the onset of anaerobic conditions, an infiltration BMP designed for water quality treatment purposes shall be designed to drain the water quality design treatment volume within 48 hours. The water quality design treatment volume is reported by the approved models.
 - The drawdown time can be calculated by using a horizontal projection of the infiltration basin mid-depth dimension and the design infiltration rate. Refer to *Section 4.5.2* for soil requirements for water quality treatment.
- (C) To meet flow control standards with infiltration:
- This design allows less than 100 percent infiltration as long as any BMP overflows meet the numerical peak and/or duration standards outlined in *Volume 1, Section 3.2*. Set up the model as explained for 100 percent infiltration (option A). Run the model and review the flow duration and flow frequency results to determine if the standard is achieved.

4.5.2. *Soil Requirements for Water Quality Treatment*

The soil requirements for water quality treatment vary depending on the type of infiltration BMP. Many infiltration BMPs (e.g., infiltration basins, infiltration trenches, and permeable pavement facilities) rely on the properties of the underlying soils (i.e., existing underneath the facility) to meet water quality treatment requirements. Bioretention systems utilize imported soils meeting specific criteria to meet water quality treatment requirements. The following sections summarize the applicable soil requirements for both categories of BMPs.

4.5.2.1. *Underlying Soil Requirements for Infiltration BMPs*

Infiltration basins, infiltration trenches, and permeable pavement facilities meet the requirements for basic, phosphorus, and enhanced treatment provided that the following soil suitability criteria are met:

- **Soil Suitability Criteria #1** – For infiltration BMPs used for treatment purposes, the measured (initial) soil infiltration rate shall be 9 inches/hour, or less. Design (long-term) infiltration rates up to 3.0 inches/hour can also be considered, if the infiltration receptor is not a sole-source aquifer as designated by EPA Region 10, and in the judgment of the experienced licensed professional, the treatment soil has characteristics comparable to those specified in Soil Suitability Criteria #2 to adequately control target pollutants.
- **Soil Suitability Criteria #2** – The underlying soil for a depth of at least 18 inches shall meet the following conditions:
 - Cation exchange capacity (CEC), as determined by U.S. EPA Method 9081, of the soil shall be greater than or equal to 5 milliequivalents per 100 grams of dry soil. Lower CEC content may be considered if it is based on a soil loading capacity determination for the target pollutants that is approved by the Director.
 - Organic content of the treatment soil (ASTM D 2974): Organic matter can increase the sorptive capacity of the soil for some pollutants. Soil organic content should be at least 1 percent; however, the licensed professional designing the facility shall evaluate whether the organic matter content is sufficient for control of the target pollutant(s).
- **Soil Suitability Criteria #3** – Waste materials of any kind, including recycled materials, shall not be used as infiltration media.

[If existing site soils do not meet these criteria, the appropriate type of water quality treatment BMP \(Enhanced, Phosphorus, or Basic\) is required prior to infiltration. Refer to Volume 1, Section 5.4.2 for the water quality treatment standards to be met and Section 3.5 of this volume to determine the type of water quality treatment BMP to use to meet those standards.](#)

4.5.2.2. *Imported Soil and Sand*

Infiltrating bioretention facilities (*Section 5.4.4*) meet the requirements for basic and enhanced treatment, but are not subject to the same underlying soil ~~infiltration-treatment~~ requirements for infiltration basins, infiltration trenches, and permeable pavement facilities (i.e., soil suitability criteria #1 through #3) because they use the City-specific standards for

the imported bioretention soil mix. Soil requirements for bioretention facilities are provided in *Section 5.4.4.5*.

If permeable pavement is being designed to provide water quality treatment and the existing subgrade does not meet requirements for treatment soil provided in *Section 4.5.2*, a 6-inch water quality treatment course shall be included between the subbase and the storage reservoir. The course shall be composed of a media meeting the treatment soil criteria (*Section 4.5.2*) or the sand media material specification for sand filters in *Section 5.8.5*.

CHAPTER 5 – BMP DESIGN

For each BMP in this chapter, detailed technical information is organized as follows:

- **Description:** provides a description of the BMP and each of the BMP configurations.
- **Performance Mechanisms:** defines how pollutants are removed (treatment mechanisms) and/or how stormwater discharge is managed (flow control mechanisms).
- **Applicability:** lists the BMP configurations that can be designed to meet the requirements for on-site stormwater management, flow control, water quality treatment (basic, enhanced, oil control, phosphorus), and/or conveyance.
- **Site Considerations:** identifies the limitations associated with siting each BMP. The application of a BMP may be constrained by factors such as approximate footprint, groundwater elevation, soil characteristics, and other site-specific conditions.
- **Design Criteria:** provides descriptions and specifications for BMP components and materials.
- **BMP Sizing:** presents sizing requirements and modeling procedures for each BMP. General modeling guidance is provided in *Appendix F*.
- **Minimum Construction Requirements:** describes critical considerations during construction of the BMP, such as erosion control, landscape stabilization, and timing of BMP installation.
- **Operations and Maintenance Requirements:** provides a reference to the operations and maintenance (O&M) requirements included in *Appendix G*.

5.1. Soil Amendment BMP

5.1.1. Description

Site soils shall meet minimum quality and depth requirement at project completion.

~~Requirements may be achieved by either retaining and protecting undisturbed soil or restoring the soil.~~ This code requirement shall be met by:

- Retention and protection of undisturbed soil; or
- Restoration of soil quality and depth (e.g., amending with compost) in disturbed areas

Additional guidance for this BMP can be found in Seattle Tip 531, Post Construction Soil Management, and *Building Soil: Guidelines and Resources for Implementing Soil Quality and Depth BMP T5.13* (Stenn et al. ~~2018~~2012), which is available at the building soil website (www.buildingsoil.org).

5.1.2. Performance Mechanisms

Naturally occurring (undisturbed) soil, soil organisms, and vegetation provide the following important stormwater management functions:

- Water infiltration
- Nutrient, sediment, and pollutant adsorption
- Sediment and pollutant biofiltration
- Water interflow storage and transmission
- Pollutant decomposition

These functions are largely lost when development strips away underlying soil and vegetation and replaces it with minimal soil and sod. Soil amendment helps to regain greater stormwater functions in the post development landscape, provide increased treatment of pollutants and sediments that result from development and habitation, and minimize ~~the need for some landscaping reliance on~~ chemicals for weed/pest control or plant vigor, thus ~~reducing pollution~~ protecting water quality through prevention.

5.1.3. Applicability

Soil amendment BMP requirements are applicable to all areas subject to clearing, grading, or compaction (including construction laydown areas) that have not been covered by ~~hard impervious~~ surface, incorporated into a stormwater BMP drainage facility, or engineered for stability as (e.g., structural fill or cut slope(s) for sediment and erosion control). ~~shall, at project completion, meet the soil amendment BMP requirements.~~ Only the areas of the sites where existing vegetation and/or soil are disturbed or compacted are required to be restored.

Soil amendment can also be used to help achieve on-site stormwater management ~~and~~ flow control, and water quality treatment standards. Refer to when integrated into a dispersion BMP (refer to Section 5.3) for integrating soil amendment with dispersion BMPs and Section 5.1.6 for modeling amended soils.

5.1.4. *Site Considerations*

On slopes exceeding 33 percent, soil amendment is not required, but may be used if recommended by a licensed professional.

~~At project completion, meet soil amendment requirements for all areas subject to clearing, grading, or compaction that have not been covered by a hard surface, incorporated into a drainage facility, or engineered as structural fill or slope. Only the areas where existing vegetation and/or soil are disturbed or compacted are required to be restored.~~

5.1.5. *Design Criteria*

This section describes the implementation options and design requirements for the soil amendment BMP. Typical cross-sections of compost-amended soil in planting bed and turf applications are shown in Figure 5.1. Design criteria are provided in this section for the following elements:

- [Soil amendments](#)
- Implementation options
- Soil retention
- ~~Soil quality~~
- Soil Management Plan

5.1.5.1. *Soil AmendmentsQuality*

Soil organic matter is often missing from disturbed soils. Replenish organic matter by amending with compost. Standardized “pre-approved” soil amendment rates have been established for planting beds and turf areas. Alternatively, custom amendment rates may be calculated. Both options are described in further detail in the subsequent section.

All areas subject to clearing and grading that have not been covered by hard surface, incorporated into a drainage facility, or engineered as structural fill or slope shall, at project completion, demonstrate the following:

- A topsoil layer, whether stockpiled soil, amended soil or imported soil, meeting these requirements:
 - An organic matter content, as measured by the loss-on-ignition test, of a minimum 8 percent (target 10 percent) dry weight in planting beds, or a minimum 4 percent (target 5 percent) organic matter content in turf areas. Acceptable test methods for determining loss-on-ignition soil organic matter include the most current version of ASTM D2974 (Test Methods for Moisture, Ash, and Organic Matter of Peat and Other Organic Soils) and TMECC 05.07A (Loss-On-Ignition Organic Matter Method).
 - A pH from 6.0 to 8.0 or matching the pH of the original undisturbed soil.
 - A minimum depth of 8 inches.

- These requirements may be met with the City of Seattle Standard Specifications: 9-14.1(1) Topsoil Type A – Imported; 9-14.1(2) Reused Amended Site Soil; 9-14.1(4) Planting Soil; or 9-14.1(5) General Turf Area Soil.
- Root zones within the dripline of existing trees to be retained must be protected from all disturbance and/or construction impacts. Refer to City of Seattle Standard Plan No. 133 and Standard Specification 8-01.3(2)B for applicable tree retention requirements. where tree roots limit the depth of incorporation of amendments are exempted from this requirement. Fence and protect these root zones from stripping of soil, grading, or compaction to the maximum extent practical.
- Scarify subsoils below the topsoil layer at least 4 inches for a finished minimum depth of 12 inches of uncompacted soil. Incorporate some of the upper material to avoid stratified layers, where feasible.
- After planting: mulch planting beds with 2 to 4 inches of organic material such as arborist wood chips, medium compost, or coarse bark, shredded leaves, compost, etc.
- Use compost and other materials that meet either of the two the following organic content requirements:
 - The organic content for “pre-approved” amendment rates can only be met using compost that meets the definition of “composted materials” in WAC 173-350 Section 220. Compost meeting the City of Seattle Standard Specification 9.14.4(8) Compost is recommended but not required. The compost shall have an organic matter content of 40 percent to 65 percent, and a carbon to nitrogen ratio below 25:1. As an exception, the carbon to nitrogen ratio may be as high as 35:1 for plantings composed entirely of plants native to the Puget Sound Lowlands region.
 - Calculated amendment rates may be met through use of composted materials as defined above, or other organic materials amended to meet the carbon to nitrogen ratio requirements, and meeting the contaminant standards compost specified in WAC 173-350 Section 220. Refer to the *Building Soil* manual (Stenn et al. 20182042) or website (www.buildingsoil.org) for the method of calculating custom amendment rates.

Ensure that the resulting soil is conducive-suitable for to the type (species) of vegetation to be established. A qualified horticultural, soil or landscape design professional may submit a Soil Management Plan showing different amounts or types of soil amendment and mulch than those described in the “pre-approved” rates. Carbon-to-nitrogen ratios and soil pH may also be varied to suit plant needs. The Soil Management Plan shall describe how the soil preparation is conducive to the type of vegetation to be established. It shall still provide the required uncompacted soil depth and as much organic matter as the vegetation will tolerate, with an appropriate surface mulch after planting.

5.1.5.2. Implementation Options

The soil quality design requirements can be met by using one of the four options listed below:

1. Retain and Protect Undisturbed Soil:
 - Leave undisturbed vegetation and soil, and protect from compaction by fencing and keeping materials storage and equipment off these areas during construction.

[Refer to City of Seattle Standard Specification 8-01.3\(2\)B for protection requirements such as fencing and other applicable protection measures.](#)

- o For all areas where soil or vegetation are disturbed, use option 2, 3, or 4.

2. Amend Soil:

- o Amend existing site *in situ* topsoil or subsoil either at default “pre-approved” rates, or at custom calculated rates to meet the soil quality guidelines based on engineering tests of the soil and amendment. The default pre-approved rates are:
 - In planting beds: place 3 inches of compost and till in to an 8-inch depth.
 - In turf areas: place 1.75 inches of compost and till in to an 8-inch depth.
 - Scarify (loosen) subsoil 4 inches below amended layer to produce a 12-inch depth of un-compacted soil.
 - After planting: apply 2 to 4 inches of arborist wood chips, [medium compost](#), or [coarse](#) compost ~~mulch to in the~~ planting beds. Coarse bark mulch may be used but has lower benefits to plants and soil. Do not use fine bark because it can seal the soil surface.

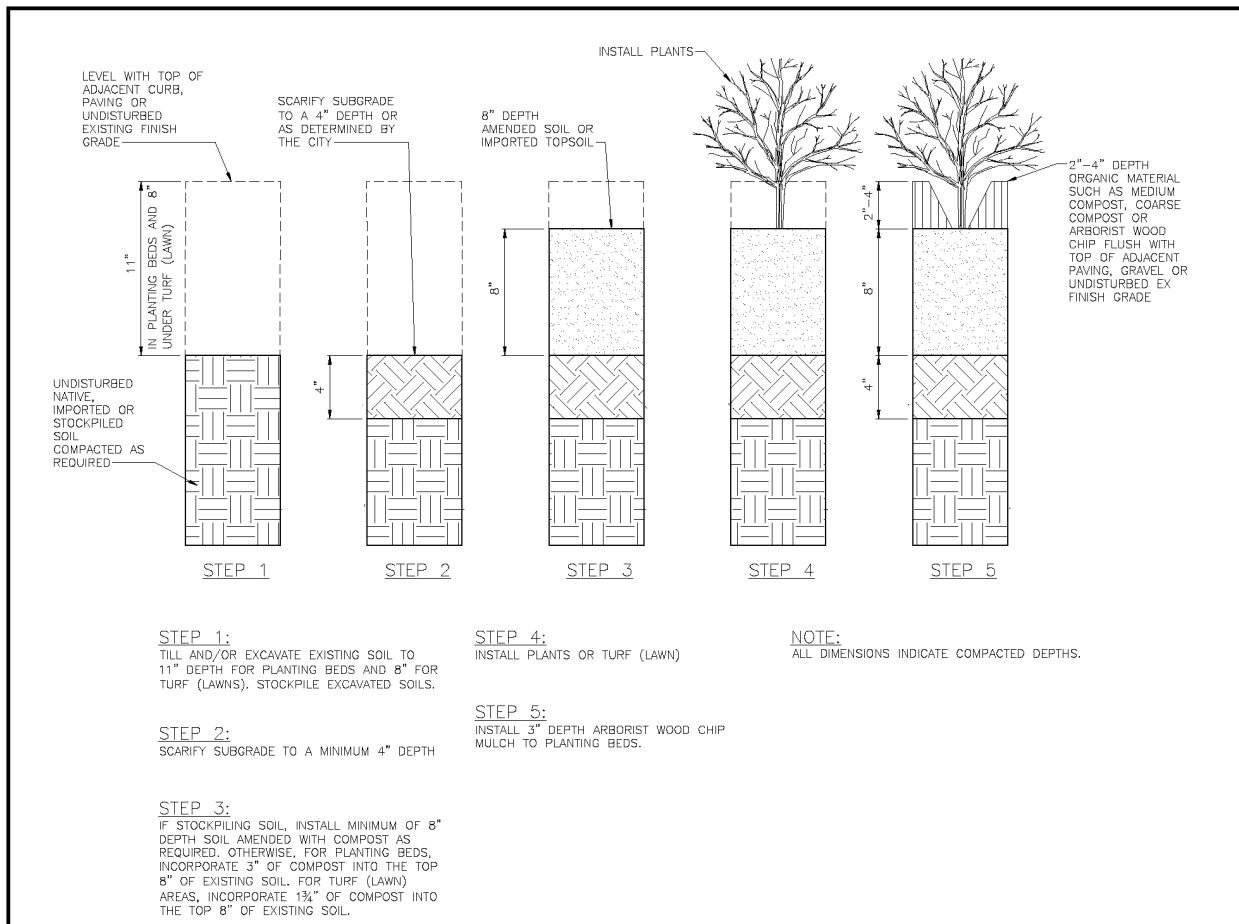

Figure 5.1. Cross-Section of Soil Amendment.

3. Stockpile Soil:

- Stockpile existing topsoil during grading and replace it prior to planting. Amend stockpiled topsoil if needed to meet the organic matter or depth requirements either at the default “pre-approved” rate or at a custom calculated rate (refer to the Building Soil manual [Stenn et al. [20182012](#)] or website (www.buildingsoil.org), for custom calculation method). Scarify subsoil and mulch planting beds, as described in option (2) above.

4. Import Soil:

- Import topsoil mix of sufficient organic content and [install to meet](#) depth ~~to meet the~~ requirements. Imported soils should not contain excessive clay or silt fines (more than 5 percent passing the No. 200 sieve) because that could restrict stormwater infiltration. The default pre-approved rates for imported topsoils are:
 - For planting beds: use a mix by volume of 35 percent compost with 65 percent mineral soil to achieve the requirement of a minimum 8 percent (target 10 percent) organic matter by loss-on-ignition test.
 - For turf areas: use a mix by volume of 20 percent compost with 80 percent mineral soil to achieve the requirement of a minimum 4 percent (target 5 percent) organic matter by loss-on-ignition test.
 - Scarify subsoil and mulch planting beds, as described in option (2) above.

Note: More than one method may be used on different portions of the same site.

5.1.5.3. Soil Retention

Retain and protect the duff layer and native topsoil in an undisturbed state to the maximum extent feasible, and protect from compaction (SMC, Section 22.805.020.D.2).

~~Prior to disturbance of areas not subject to soil retention requirements, in any areas requiring grading, remove, and stockpile, and protect the duff layer and topsoil on site in a designated, controlled area, which is not adjacent to public resources and critical areas. Distribute stockpiled materials to areas shown on project plans for new tree and/or plant installation. Reapply to other portions of the site where feasible.~~

Root zones where tree roots limit the depth of incorporation of amendments are exempted from this requirement. Fence and protect these root zones from stripping of soil, grading, or compaction to the maximum extent practical.

5.1.5.4. Soil Management Plan

A Soil Management Plan is required and shall include the following:

- A site map showing areas to be fenced and left undisturbed during construction, and areas that will be amended at the turf or planting bed rates
- Calculations of the amounts of compost, compost amended topsoil, and mulch to be used on the site.

5.1.6. BMP Sizing

When the soil amendment BMP is applied as part of a dispersion BMP design, the On-Site List Requirement is met for the hard surface area that is dispersed. On-site stormwater management and flow control standards can also be met or partially met as described under the following sections:

- Full Dispersion (*Section 5.3.2*)
- Splashblock Downspout Dispersion (*Section 5.3.3*)
- Trench Downspout Dispersion (*Section 5.3.4*)
- Sheet Flow Dispersion (*Section 5.3.5*)
- Concentrated Flow Dispersion (*Section 5.3.6*)

~~All lawn and landscaped areas that meet the soil amendment BMP requirements are amended using implementation options 2, 3, or 4 from Section 5.1.5.2 will generate less runoff and may be modeled as pasture rather than lawn (WWHM) or grass (MGSFlood) surface over the underlying soil (till or outwash).~~

5.1.7. Minimum Construction Requirements

Minimum construction requirements for disturbed areas include the following:

- Incorporate soil to meet Soil Amendment BMP requirements toward the end of construction, ~~and once established,~~ protect amended areas from ~~compaction and erosion or damage by work as well as any other site improvements to follow.~~
- Plant soil with appropriate vegetation and mulch planting beds.

Additional information is provided in the *Building Soil* manual (Stenn et al. ~~2018~~2012).

5.1.8. Operations and Maintenance Requirements

The most important maintenance ~~issue-practice~~ is to replenish the soil organic matter by leaving leaf litter and grass clippings on-site (or by adding compost and mulch regularly). ~~This BMP is designed to reduce the need for irrigation, fertilizers, herbicides, and pesticides. This routinely scheduled task is necessary to minimize reliance on chemicals for weed/pest control or plant vigor, thus protecting water quality.~~

5.2. Tree Planting and Retention

5.2.1. Description

New trees can be planted and/or existing trees can be protected and retained on a project site to achieve on-site stormwater management and/or flow control credits.

5.2.2. Performance Mechanisms

Trees provide flow control via interception, transpiration, and increased infiltration. Additional environmental benefits include improved air quality, carbon sequestration, reduced heat island effect, pollutant removal, and habitat.

5.2.3. Applicability

Retained and newly planted trees receive credits toward meeting on-site stormwater management and flow control requirements. The degree of flow control that can be provided depends on the tree type (i.e., evergreen or deciduous), canopy area, and whether or not the tree canopy overhangs hard surfaces. [Retained and newly planted trees](#) ~~This BMP~~ can be applied to meet or partially meet the requirements listed below.

BMP	On-site		Flow Control			Water Quality				Conveyance
	List	Standard	Forest	Pasture	Peak	Basic	Enhanced	Oil Control	Phosphorus	
Tree Planting and Retention	✓	✓ ^a	✓ ^a	✓ ^a	✓ ^a					

^a Standard may be partially achieved.

5.2.4. Site Considerations

Trees ~~can provide are a landscape amenity with~~ flow control benefits ~~that can be planted or retained in most settings~~. On-site stormwater management and/or flow control credit is ~~given~~ [provided](#) for ~~retaining-retained~~ or ~~planting-newly planted~~ trees within 20 feet of ground level hard surfaces such as driveways, patios, and parking lots. Refer to *Appendix C* for additional infeasibility criteria for the On-site List Approach.

Retained or newly planted trees may also count toward Green Factor, landscaping, and/or tree protection requirements.

Site considerations specific to retained and newly planted trees are provided below.

5.2.4.1. Retained Trees

Setbacks of proposed infrastructure from existing trees are critical [site-planning](#) considerations. Tree protection requirements limit grading and other disturbances in

proximity to the tree (refer to SMC Chapter 25.11, City of Seattle Standard Specification 1-07.16(2), 8-01.3(2)A and City of Seattle Standard Plan No. 132 and 133).

5.2.4.2. *Newly Planted Trees*

Mature tree height, size, and rooting depth shall be considered to ensure that the tree location is appropriate given adjacent and above- and below-ground infrastructure. Although setbacks will vary by species, some general recommendations are presented below.

- Minimum 5-foot or 1/3 the mature canopy diameter, whichever is greater, setback from structures
- Minimum 5-foot setback from underground utility lines
- Minimum 2-foot setback from edge of any paved surface

5.2.5. *Design Criteria*

This section provides the design requirements for retained trees and newly planted trees.

5.2.5.1. *Retained Trees*

To quality for achieve on-site stormwater management and/or flow control credits by retaining trees on the project site, the requirements described below must-shall be met. Design criteria are provided in this section for the following elements:

- Tree species and condition
- Tree size
- Tree canopy area (based on dripline delineation)
- Tree location (with setbacks from ground level hard surfaces and underground utilities)

Tree Condition and Compatibility with Construction

Clearly show existing tree species and tree locations on submittal drawings. Trees to be retained shall be adequately viable for long-term retention (i.e., in good health and compatible with proposed construction).

Tree Size

To receive on-site stormwater management and and/or flow control credit, retained trees shall have a minimum 4 inch diameter at breast height (DBH). DBH is defined as the outside bark diameter at 4.5 feet above the ground on the uphill side of a tree. For existing trees smaller than this, the newly planted tree credit may be applied if the requirements presented in *Section 5.2.5.2 Newly Planted Trees* are met.

Tree Canopy Area

The canopy area of the retained tree is measured as the area within the tree dripline. A dripline is the line encircling the base of a tree, which is delineated by a vertical line extending from the outer limit of a tree's branch tips down to the ground (refer to City of

Seattle Standard Plan [No. 133](#)). If trees are clustered, overlapping canopies are not double counted.

Tree Location

The credit for retained trees depends upon proximity to ground level hard surfaces. To receive credit, the existing tree shall be located on the development site [or abutting right-of-way](#) and within 20 feet of new or replaced ground level hard surfaces (e.g., driveway, patio, parking lot). For single-family residential projects only, credit is also given for trees that are 20 feet or less from existing ground level hard surfaces in the right-of-way (e.g., sidewalk). Distance from the edge of hard surfaces is measured from the tree trunk center at ground level. Refer *Section 5.2.4.1* for other setbacks applicable to retained trees.

The City may require an arborist report if a hard surface is proposed within the critical root zone of the existing tree. The critical root zone is defined as the line encircling the base of the tree within half the diameter of the dripline (refer to City of Seattle Standard Plan [No. 133](#)). If the arborist report concludes that the hard surface should not be placed within 20 feet of the tree trunk center, but canopy overlap with hard surface is still anticipated [given despite](#) a longer setback, credit may be approved.

Retained trees planted in planter boxes are eligible for credit if the planters provide a minimum soil depth of 30 inches and meet the minimum soil volume standards presented in Table 5.1.

Table 5.1. Minimum Soil Volume for Trees in Planters.

Tree Size Category ^a	Planting Area Soil Volume ^b	Planting Surface Area ^c	Example Dimensions ^c
Small Trees	Small trees not eligible for credit		
Small/Medium Trees	225 cubic feet	90 square feet	5 feet x 18 feet
Medium/Large Trees	375 cubic feet	150 square feet	6 feet x 25 feet
Large Trees	525 cubic feet	210 square feet	7 feet x 30 feet

^a Tree size categories from the City of Seattle Master Tree List.

^b Note that these are minimum soil volume requirements. Trees will be healthier, bigger, and longer-lived if greater soil volume is provided.

^c Surface area and example dimensions assume a 30-inch soil depth. Smaller surface areas can achieve the same volume if a deeper soil profile is provided, or if adjacent paved surfaces are [installed over structural soil or similar technologies engineered for structural support](#).

5.2.5.2. *Newly Plantedly Planted Trees*

To achieve on-site stormwater management and/or flow control credits by planting trees on a project site, the requirements described below [must shall](#) be met. Design criteria are provided in this section for the following elements:

- Tree species
- Tree size
- Tree location (with setbacks from ground level hard surfaces structures and belowground utilities)

- Plant material and planting specifications
- Irrigation

Tree Species

Approved tree species are listed in the [reference materials posted on City of Seattle Master Tree List \(Approved Tree List\) available via link from the SDCI's website \(www.seattle.gov/sdci/codes/codes-we-enforce-\(a-z\)/stormwater-codeswww.seattle.gov/dpd/codesrules/codes/stormwater\)](#). Trees in the small category are not eligible for credit. Tree species not included ~~in~~ on the [reference materials posted on SDCI's websiteCity of Seattle Master Tree List](#) may be given credit with [the permissionprior approval by of](#) the Director.

Tree Size

To receive on-site stormwater management and/or flow control credit, new deciduous trees [with a single trunk](#) shall be at least 1.5 inches in diameter measured 6 inches above the ground. [New deciduous trees with a single trunk planted in the right-of-way shall be 2 to 2.5 inches in diameter \(e.g., caliper\) measured 6 inches above the ground. Multi-stemmed deciduous trees shall have at least three stems and be at least 6 feet tall.](#) New evergreen trees shall be at least 4 feet tall.

Tree Location

[Site-Locate](#) trees according to sun, soil, and moisture requirements. Select planting locations to ensure that sight distances and appropriate setbacks are maintained given mature height, size, and rooting depths.

Trees used to receive the newly planted tree credit shall meet the tree location requirements listed in *Section 5.2.5.1, Retained Trees*. Refer to *Section 5.2.4.2* for other setbacks applicable to new trees.

To help ensure tree survival and canopy coverage, the minimum tree spacing for newly planted trees shall accommodate mature tree spread (refer to [the reference materials posted on SDCI's websiteCity of Seattle Master Tree List](#)). On-site stormwater management and/or flow control credit will not be given for new trees with on-center spacing less than 10 feet.

New trees planted [in planter boxes on site or specifically approved and permitted for public right-of-wayin planter boxes](#) are eligible for credit if the planters provide a minimum soil depth of 30 inches and meet the minimum soil volume standards presented in Table 5.1.

Plant Material and Planting Specifications

Recommended guidelines for planting materials and methods are provided in City of Seattle Standard Specifications 8-02 and 9-14, and Standard Plan No. 100a, 100b, and 101.

5.2.6. BMP Credits

5.2.6.1. Credit for On-site List Approach

Hard surface areas managed by newly planted trees meet the On-site List Requirement (refer to *Section 3.3.1*). Trees shall meet the Design Criteria in *Section 5.2.5* ~~and shall be planted to the maximum extent feasible~~. Retained trees meeting the requirements presented in this section may be ~~also be used in lieu of newly planted trees~~ to meet the on-site list requirement.

[On-site stormwater management credits for retained and newly planted trees are provided in Tables 5.2 and 5.3. These credits can be applied to reduce the hard surface area requiring on-site stormwater management.](#)

Table 5.2. Pre-sized [On-site Stormwater Management and Flow Control Credits](#) for Retained Trees.

Tree Type	Credit
Evergreen	20% of canopy area (minimum of 100 square feet/tree)
Deciduous	10% of canopy area (minimum of 50 square feet/tree)

Hard Surface Area Managed = Σ Canopy Area x Credit (%) / 100.

Table 5.3. Pre-sized [On-site Stormwater Management and Flow Control Credits](#) for Newly Planted Trees.

Tree Type	Credit
Evergreen	50 square feet/tree
Deciduous	20 square feet/tree

Hard Surface Area Managed = Σ Number of Trees x Credit (square feet/tree).

5.2.6.2. Pre-Sized Approach for Flow Control

The Pre-sized Approach may be used for projects with new and replaced hard surface areas up to 10,000 square feet. Flow control credits for retained and newly planted trees are provided in Tables 5.2 and 5.3. These credits can be applied to reduce the hard surface area requiring flow control.

To use these credits, the requirements outlined in *Section 5.2.5 Design Criteria* ~~must~~ shall be met. The total tree credit for retained and newly planted trees shall not exceed 25 percent of the new plus replaced hard surface requiring mitigation. Tree credits are not applicable to trees located in native vegetation areas used for flow dispersion or other flow control or on-site stormwater management credit.

5.2.6.3. Modeling Approach for On-site Performance Standard and Flow Control

When using the Modeling Approach to meet the On-Site Performance Standard or flow control standards, the credits for retained and newly planted trees (Tables 5.2 and 5.3) can be applied as explained for the *Pre-sized Approach for Flow Control*. The hard surface areas credited by the retained and newly planted trees need not be entered into the continuous

[runoff](#) hydrologic model when sizing other on-site stormwater management or flow control BMPs.

5.2.7. *Minimum Construction Requirements*

[Install and maintain fence](#) and protect the existing tree roots [within the dripline and provide additional protection for](#), trunk, [structural branches and](#) ~~and~~ [full canopy extents](#) during construction activities per SMC Tree Protection Chapter 25.11, City of Seattle Standard Specification 1-07.16(2), 8-01.3(2)A, and City of Seattle Standard Plan No. 132a and 133.

Planting methods for new trees are provided in *Section 5.2.5.2 Newly Planted Trees*.

5.2.8. *Operations and Maintenance Requirements*

The following O&M requirements apply to retained trees:

- [Retain, maintain, and protect trees on the site for the life of the development or until any approved redevelopment occurs.](#)
- [Prune when necessary, for compatibility with site uses or right of way functions, for clearances from public and privately owned infrastructure and/or to avoid damage to trees, important to preserve the health and longevity of trees.](#) ~~when necessary, for compatibility with other infrastructure and/or to preserve the health and longevity of trees.~~ Meet industry standards for pruning (ANSI A300 standards).
- [Replenish mulch annually to retain soil moisture.](#)

The following O&M requirements apply to newly planted trees:

- [Provide supplemental irrigation for at least five](#) ~~during the first three~~ growing seasons after planting to help ensure tree survival.
- [Replenish mulch annually to retain soil moisture.](#)

Additional O&M requirements for dead or declining trees are provided in *Appendix G (BMP No. 26)*.

5.3. Dispersion BMPs

Dispersion BMPs disperse runoff over vegetated pervious areas to provide flow control. The dispersion BMPs in this section include:

- Full dispersion
- Splashblock downspout dispersion
- Trench downspout dispersion
- Sheet flow dispersion
- Concentrated flow dispersion

Key design requirements that are common to all dispersion BMPs are provided in *Section 5.3.1*. Guidance and requirements that are specific to the different types of dispersion are provided in the subsequent sections.

5.3.1. Design Requirements for Dispersion BMPs

5.3.1.1. General Site Considerations

The following are key considerations in determining the feasibility of dispersion BMPs for a particular site:

- Dispersion flowpath area – Dispersion BMPs generally require large areas of vegetated ground cover to meet flowpath requirements and are not feasible in most urban settings.
- Erosion or flooding potential – Dispersion is not allowed in settings where the dispersed flows might cause erosion or flooding problems, either onsite or on adjacent properties.
- Site topography – Dispersion flowpaths are prohibited in and near certain sloped areas (refer to flowpath requirements below).

5.3.1.2. General Design Criteria for Dispersion Flowpaths

Flowpath design requirements that are common to all dispersion BMPs are listed below. Additional requirements that are specific to each of the dispersion types are provided in each BMP section.

- The vegetated flowpath shall consist of either undisturbed, well-established native landscape or lawn, or landscape or groundcover over soil that meets the Soil Amendment BMP requirements outlined in *Section 5.1*.
- To ensure that the groundcover is dense to help disperse and infiltrate flows and prevent erosion, the design plans shall specify that vegetation coverage of plants will achieve 90 percent coverage within 1 year.
- The flowpath topography shall promote shallow sheet flow across a width of no less than 6 feet for dispersion points (i.e., splashblocks or rock pads) or the width of the dispersion device (i.e., trench or sheet flow transition zone).

- The dispersion flowpath is not typically permitted within landslide-prone areas as defined by the Regulations for Environmentally Critical Areas (SMC, Section 25.09.020).
- The dispersion flowpath is not typically permitted within a setback above a steep slope area (SMC, Section 25.09.020). The setback is calculated as 10 times the height of the steep slope area (to a 500 foot maximum setback). Dispersion within this setback may be feasible provided a ~~detailed~~ slope stability analysis is completed by a geotechnical engineer. The analysis shall determine the effects that dispersion would have on the steep slope area and adjacent properties.
- The dispersion flowpath is not permitted within 100 feet of a contaminated site or landfill (active or closed).
- For sites with septic systems, the point of discharge to the dispersion device (e.g., splash block, dispersion trench) shall be downgradient of the drainfield primary and reserve areas.

5.3.2. Full Dispersion

On-site stormwater management, flow control, and/or water quality treatment standards may be provided using full dispersion as presented in the *Stormwater Management Manual for Western Washington* (SWMMWW). The requirements for full dispersion are difficult to achieve in an urban setting. As an example, [for the entire site of a residential development to be fully dispersed, its ~~must shall~~ preserve 65 percent ~~of a site~~ in a forested or native condition and limit the impervious site coverage to 10 percent. \[However, if the entire site cannot be fully dispersed, portions of it may be fully dispersed if there is a vegetated flow path of at least 100 feet downstream of the surface to be dispersed.\]\(#\) Given the large extent of vegetative cover required for full dispersion, these credits will most likely only apply to Seattle Parks or large campus projects.](#)

Refer to BMP T5.30 in Volume V of the SWMMWW for full dispersion applicability, site considerations, design criteria, modeling requirements, and minimum construction requirements.

5.3.3. Splashblock Downspout Dispersion

5.3.3.1. Description

Splashblock downspout dispersion consists of a splashblock or crushed rock pad used to disperse downspout flows to a downslope well-vegetated flowpath of at least 50 feet.

5.3.3.2. Performance Mechanisms

Splashblock downspout dispersion can provide flow control via attenuation, soil storage, and losses to infiltration, evaporation, and transpiration.

5.3.3.3. Applicability

Splashblock downspout dispersion can be designed to provide on-site stormwater management and flow control. This BMP can be applied to meet or partially meet the requirements listed below. If the designer implements a dispersion BMP to meet water quality treatment standards, the BMP shall be designed using the additional design requirements for [vegetatedbasic](#) filter strips per *Section 5.8.4*.

BMP	On-site		Flow Control			Water Quality				Conveyance
	List	Standard	Forest	Pasture	Peak	Basic	Enhanced	Oil Control	Phosphorus	
Splashblock downspout dispersion	✓	✓ ^a	✓ ^a	✓ ^a	✓ ^a	✓ ^b				

^a Standard may be partially or completely achieved depending upon underlying soil type.

^b ~~Must~~ Shall meet additional design requirements for [vegetatedbasic](#) filter strips (refer to *Section 5.8.4*) [to fully meet the water quality treatment requirement](#).

5.3.3.4. Site Considerations

General site considerations for determining the feasibility of dispersion BMPs for a particular site are provided in *Section 5.3.1.1*. Refer to *Appendix C* for additional infeasibility criteria for the On-site List Approach.

5.3.3.5. Design Criteria

This section provides a description and requirements for the components of splashblock downspout dispersion. Typical components of splashblock downspout dispersion are shown in Figure 5.2. Design criteria are provided in this section for the following elements:

- Contributing area
- Splashblock or rock pad
- Dispersion flowpath
- Overflow

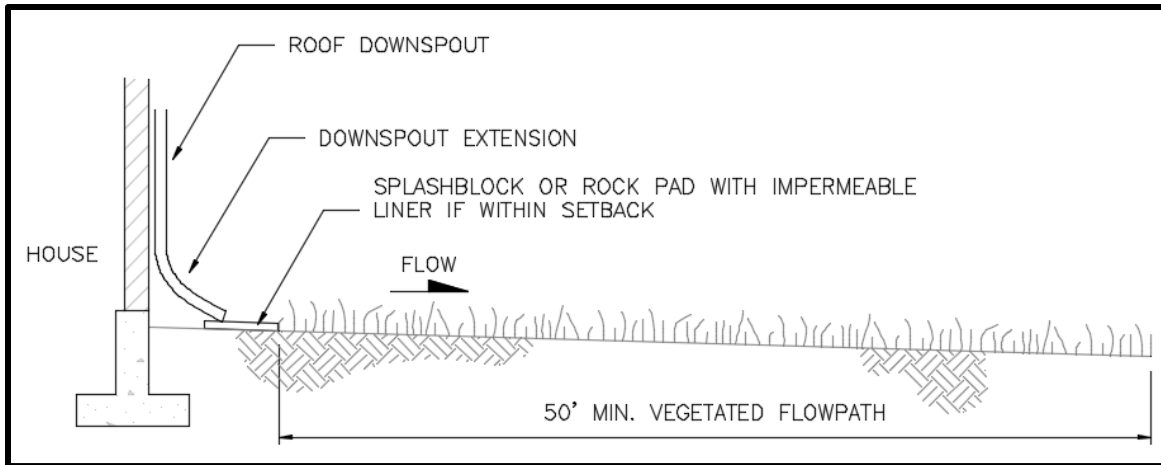

Figure 5.2. Typical Downspout Splashblock Dispersion.

Some of the critical requirements for splashblock downspout dispersion (e.g., flowpaths, setbacks) are shown in Figure 5.3.

Contributing Area

A maximum of 700 square feet of roof area may drain to each splashblock. If at least 50 percent of the roof is a vegetated roof, contributing roof areas up to 900 square feet will be allowed.

Splashblock or Rock Pad

A splashblock or a pad of crushed rock (2 feet wide by 3 feet long by 6 inches deep) shall be placed at each downspout point of discharge.

There are two approved methods for splashblock downspout dispersion:

- *Splashblock/Rock Pad*: If the ground is sloped away from the foundation, and there is adequate vegetation and area for effective dispersion, splashblocks/rock pads will typically be adequate to disperse stormwater runoff.
- *Splashblock/Rock Pad with downspout extension*: If the ground is fairly level, the building includes a basement, or if foundation drains are proposed, splashblocks with downspout extensions should be used to move the point of discharge away from the foundation. Downspout extensions can include piping to a splashblock/rock pad a considerable distance from the downspout.

The dispersion device (e.g., end of splash block, edge of rock pad, or edge of dispersion trench) shall be at least 5 feet from a structure. A 10-foot setback from a building with a basement is recommended. The rock pad shall have an impermeable liner within this setback.

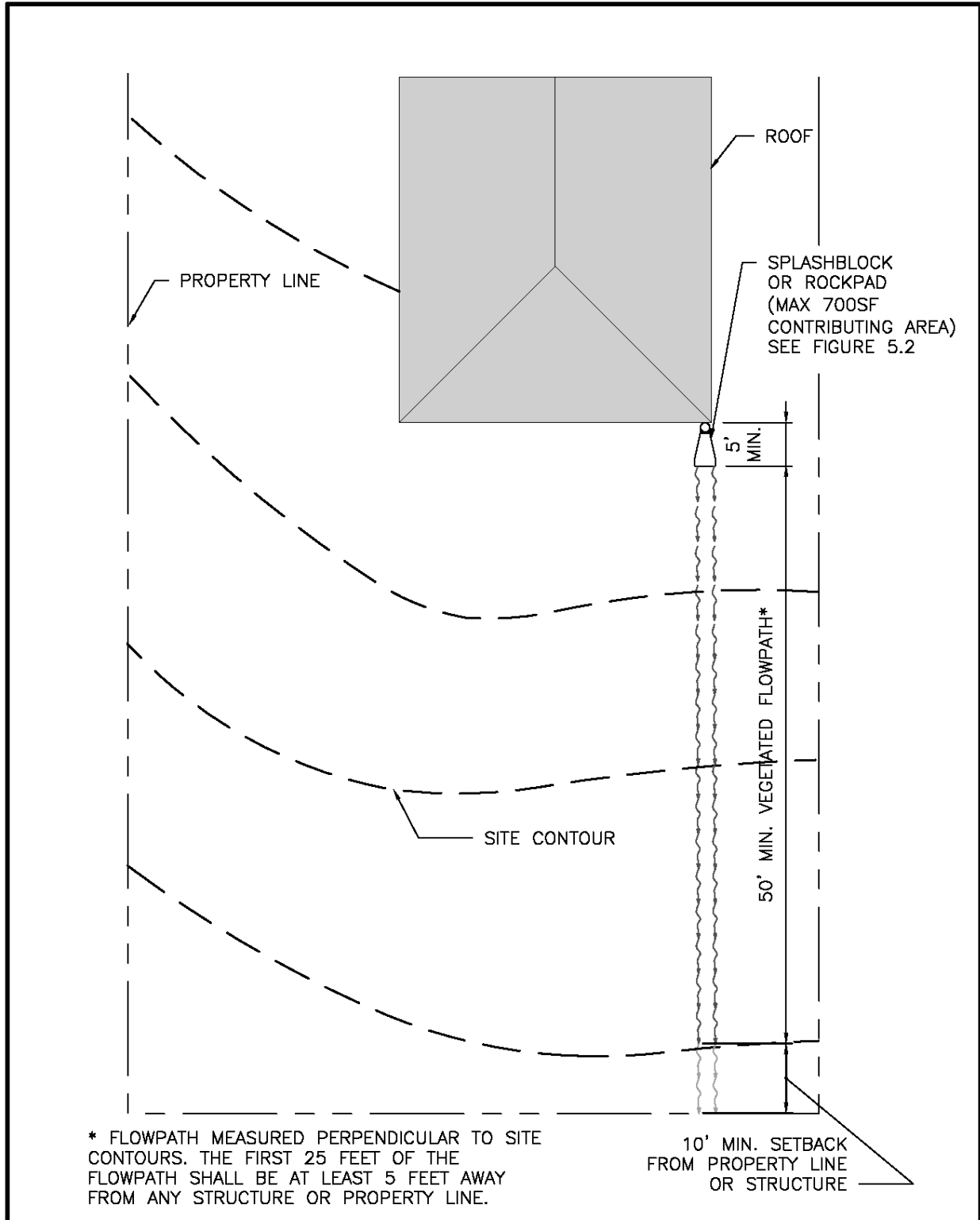

Figure 5.3. Typical Downspout Splashblock and Dispersion Trench Plan.

Dispersion Flowpath

The general minimum requirements for the dispersion flowpath are provided in *Section 5.3.1.2*. Additional flowpath requirements specific to splashblock downspout dispersion are listed below and shown in Figure 5.3:

- Provide a vegetated flowpath of at least 50 feet between the dispersion device (e.g., splash block, rock pad) and any ~~slope over 15 percent~~, stream, wetland, lake, ~~or other hard surface~~, or slope over 15 percent. Critical area buffers may count toward flowpath lengths. Measure the flowpath length perpendicular to site contours.
- The slope of the 50-foot vegetated flowpath shall not exceed 15 percent.
- Down gradient of the required 50 foot flowpath, an additional 10 feet shall be provided before the flowpath intersects a property line (~~excluding the except where the property line abutting abuts the right-of-way~~) or encounters a structure.
- ~~Install~~ The first 25 feet of the dispersion flowpath shall be at least 5 feet (perpendicular to the flowpath) from any structure or property line (except where the property line abuts the right-of-way).
- Provide a separate flowpath for each downspout dispersion device. For the purpose of maintaining adequate separation of flows discharged from adjacent dispersion devices, space vegetated flowpaths at least 20 feet apart at the upslope end and do not overlap with other flowpaths at any point along the flowpath lengths.
- For the purpose of measuring setbacks to structures, property lines or other flowpaths, assume the flowpath width to be 3 feet extending from the center line of the splashblock or rock pad. Measure setbacks from the edge of the assumed flowpath.

Overflow

Identify the overland flowpath for each downspout dispersion point. Consider surface flows that may extend beyond the design flowpath length. Do not allow flow to cause erosion or flooding onsite or on adjacent properties (refer to Section 4.3.3).

5.3.3.6. BMP Credits

Credit for On-site List Approach

The hard surface area dispersed using splashblock downspout dispersion meets the On-site List Requirement (refer to *Section 3.3.1* and *Appendix C* for infeasibility criteria).

Pre-sized Approach for Flow Control

The Pre-sized Approach may be used for projects with new and replaced hard surface areas up to 10,000 square feet. Under the Pre-sized Approach (refer to *Section 4.1.2*), flow control credits may be achieved by using downspout dispersion. Credits are provided in Table 5.4, organized by flow control standard. These credits can be applied to reduce the hard surface area requiring flow control. Since the credits for dispersion are less than 100 percent, the standard is not achieved and additional flow control measures will be required. As an example, for a site subject to the Pre-developed Pasture Standard, a dispersed hard surface area would receive a 91 percent credit. Therefore, 91 percent of the hard surface area dispersed can be excluded from flow control calculations. The hard surface area (area used to size a downstream flow control BMP) would be calculated as 9 percent of the hard surface area dispersed.

Table 5.4. Pre-Sized Flow Control Credits for Splashblock Downspout Dispersion.

Dispersion Type	Credit (%)	
	Pre-developed Pasture Standard	Peak Control Standard
Splashblock Downspout Dispersion	74% 94%	76% 94%

Hard Surface Area Managed = Hard Surface Area Dispersed x Credit (%) / 100.

The flow control credits outlined above are applicable only if downspout dispersion meets the minimum design requirements outlined in this section. Alternatively, dispersion can be evaluated using a continuous [runoff hydrologic simulation](#) model as described below.

Modeling Approach for On-site Performance Standard and Flow Control

Continuous hydrologic modeling may be used to quantify the performance of splashblock downspout dispersion relative to the on-site and flow control performance standards using the procedures and assumptions listed in Table 5.5.

Table 5.5. Continuous Modeling Assumptions for Downspout Dispersion.

Variable	Assumption
Precipitation Series	Seattle 158-year, 5-minute series
Computational Time Step	5 minutes
HSPF Parameters	LSUR, SLSUR, NSUR shall be adjusted per Appendix F
Flowpath Length	50 feet minimum
Flowpath Width	Match the width of the splash block or rock pad
Flowpath Slope	Proposed condition (15% maximum)
Roof Area Dispersed	<p>Single Downspout Option 1 (WWHM only): The connected rRoof area shall be dispersed modeled as lawn—a lateral flow impervious area over the underlying soil type (e.g., till). The lateral flow elements in WWHM are available on the Mitigated Scenario screen. The lateral flow impervious area element (roof area) should be connected to the lawn/landscape lateral flow soil basin element (the vegetated flowpath). Existing slope condition of dispersion flowpath should be used.</p> <p>Multiple Downspouts Option 2 (WWHM or MGSFlood): The roof area can be modeled as 50% landscaped (lawn in WWHM; grass in MGSFlood) and 50% impervious. Represent roof runoff dispersion using the lateral flow routine. Modeled flowpath width shall be no more than 6 feet for dispersion points (i.e., splashblocks or rock pads) or the width of the dispersion device (i.e., trench).</p>

[Refer to Section 5.1.6 for modeling amended soils to partially meet the flow control and/or water quality treatment requirement when runoff is dispersed on amended soil.](#)

5.3.3.7. Minimum Construction Requirements

Protect the dispersion flowpath from sedimentation and compaction during construction. If the flowpath area is disturbed during construction, restore the area to meet the Soil Amendment BMP requirements in *Section 5.1*, and establish a dense cover of lawn, landscape, or groundcover.

5.3.3.8. Operations and Maintenance Requirements

Splashblock downspout dispersion O&M requirements are provided in *Appendix G* (BMP No. [2524](#)).

5.3.4. Trench Downspout Dispersion

5.3.4.1. Description

Trench downspout dispersion consists of a gravel-filled dispersion trench used to disperse downspout flows to a downslope well-vegetated flowpath of at least 25 feet.

5.3.4.2. Performance Mechanisms

Trench downspout dispersion can provide flow control via attenuation, soil storage, and losses to infiltration, evaporation, and transpiration.

5.3.4.3. Applicability

Trench downspout dispersion can be designed to provide on-site stormwater management and flow control. This BMP can be applied to meet or partially meet the requirements listed below. If the designer implements a dispersion BMP to meet water quality treatment standards, the BMP shall be designed using the additional design requirements for [vegetatedbasic](#) filter strips per *Section 5.8.4*.

BMP	On-site		Flow Control			Water Quality				Conveyance
	List	Standard	Forest	Pasture	Peak	Basic	Enhanced	Oil Control	Phosphorus	
Trench downspout dispersion	✓	✓ ^a	✓ ^a	✓ ^a	✓ ^a	✓ ^b				

^a Standard may be partially or completely achieved depending upon underlying soil type.

^b Must Shall meet additional design requirements for [vegetatedbasic](#) filter strips (refer to *Section 5.8.4*) to fully meet the water quality treatment requirement.

5.3.4.4. Site Considerations

General site considerations for determining the feasibility of dispersion BMPs for a particular site are provided in *Section 5.3.1.1*. Refer to *Appendix C* for additional infeasibility criteria for the On-site List Approach.

5.3.4.5. Design Criteria

This section provides a description and requirements for the components of trench downspout dispersion. Some of the critical requirements for trench downspout dispersion (e.g., flowpaths, setbacks) are shown in Figure 5.4. Design criteria are provided in this section for the following elements:

- [Contributing area](#)
- Downspout dispersion trench
- Dispersion flowpath
- Overflow

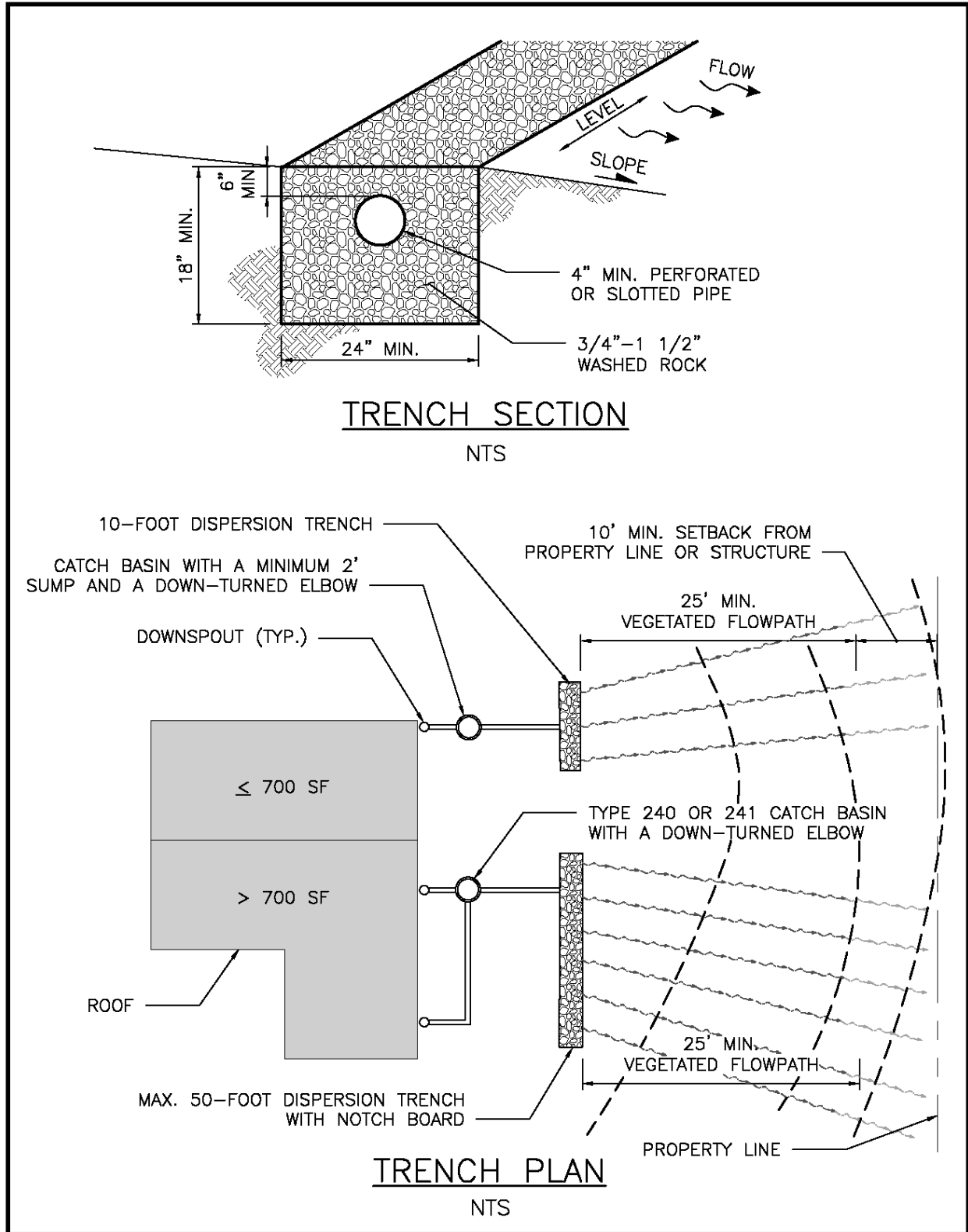

Figure 5.4. Typical Downspout Dispersion Trench.

Contributing Area

A maximum of 700 square feet of roof area may drain to each downspout dispersion trench. If at least 50 percent of the roof is a vegetated roof, contributing roof areas up to 900 square feet will be allowed.

Downspout Dispersion Trench

The minimum requirements associated with dispersion trench design include the following:

- The trench shall be a minimum of 18 inches deep and 2 feet wide.
- Trenches shall be filled with uniformly-graded, washed gravel with a nominal size from 0.75- to 1.5-inch diameter. The minimum void volume shall be 30 percent. These requirements can be met with City of Seattle Mineral Aggregate Type 4.
- The trench shall be level and aligned parallel to site elevation contours to disperse the water to the downslope flowpath. The trench shall be constructed to prevent point discharge and erosion.
- Water shall be conveyed to the trench with a solid pipe and distributed within the trench via a perforated or slotted pipe with a minimum diameter of 4 inches. Pipe cover shall be a minimum of 6 inches.
- Trenches serving up to 700 square feet of roof area shall be 10 feet long. For roof areas larger than 700 square feet, a dispersion trench with a dispersion device, such as a notched grade board, is recommended. Refer to BMP T5.10B in Volume VIII of the SWMMWW for typical plan and section views of a downspout dispersion trench with notched grade board. The total length of this design shall provide at least 10 feet of trench per 700 square feet of roof area and not exceed 50 feet. If the roof is a vegetated roof, contributing areas larger than 700 square feet may be approved for a 10-foot trench.
- A setback of at least 5 feet shall be maintained between any edge of the trench and any property line.
- The setback between any edge of the trench and any structure shall be 5 feet. A 10-foot setback from a building with a basement is recommended.

Presettling

Stormwater inflows shall be routed through a catch basin ~~or yard drain~~ with downturned elbow (trap) and 2-foot-deep sump upstream of the ~~drywell-dispersion trench~~ to capture sediment and reduce the potential for clogging. Catch basins shall be per City of Seattle Standard Plan No. 240, 241, or equivalent.

Dispersion Flowpath

The general minimum requirements for the dispersion flowpath are provided in *Section 5.3.1.2*. Additional flowpath requirements specific to trench downspout dispersion are listed below and shown in Figure 5.3:

- A vegetated flowpath shall be at least 25 feet between the outlet of the trench and ~~any~~ any property line, slope over 15 percent, stream, wetland, lake, structure, ~~or other~~

hard surface, [or slope over 15 percent](#). Critical area buffers may count toward flowpath lengths. The flowpath length is measured perpendicular to site contours.

- [The slope of the 25-foot vegetated flowpath shall not exceed 15 percent.](#)
- Down gradient of the required 25-foot flowpath, an additional 10 feet shall be provided before the flowpath intersects a property line (~~excluding~~ [except where](#) the property line ~~abutting~~ [abuts](#) the right-of-way) or encounters a structure.
- The first 25 feet of the dispersion flowpath shall be at least 5 feet ([perpendicularly to the flowpath](#)) from any structure or property line (~~excluding~~ [except where](#) the property line ~~abutting~~ [abuts](#) the right-of-way).
- Each downspout dispersion device (e.g., dispersion trench) shall have a separate flowpath. For the purpose of maintaining adequate separation of flows discharged from adjacent dispersion devices, vegetated flowpaths shall be at least 20 feet apart at the upslope end and shall not overlap with other flowpaths at any point along the flowpath lengths.
- For the purpose of measuring setbacks to structures, property lines, and other flowpaths, the flowpath width shall be assumed to be the length of the dispersion trench. Setbacks shall be measured from the edge of the assumed flowpath.

Overflow

Identify the overland flowpath for each downspout dispersion point. Consider surface flows that may extend beyond the design flowpath length. Prevent flow from causing erosion or flooding on site or on adjacent properties ([refer to Section 4.3.3](#)).

5.3.4.6. BMP Credits

Credit for On-site List Approach

The hard surface area dispersed using trench downspout dispersion meets the On-site List Requirement ([refer to Section 3.3.1](#) and [Appendix C](#) for infeasibility criteria).

Pre-sized Approach for Flow Control

The Pre-sized Approach may be used for projects with new and replaced hard surface areas up to 10,000 square feet. Under the Pre-sized Approach ([refer to Section 4.1.2](#)), flow control credits may be achieved by using downspout dispersion. The credits provided in Table 5.6 can be applied to reduce the hard surface area requiring flow control as explained for splashblock downspout dispersion ([refer to Section 5.3.3.6](#)).

Table 5.6. Pre-sized Flow Control Credits for Trench Downspout Dispersion.

Dispersion Type	Credit (%)	
	Pre-developed Pasture Standard	Peak Control Standard
Trench Downspout Dispersion	74%94%	9476%%

Hard Surface Area Managed = Hard Surface Area Dispersed x Credit (%) / 100.

Modeling Approach for On-site Performance Standard and Flow Control

Continuous hydrologic modeling may be used to quantify the performance of trench downspout dispersion relative to the on-site and flow control standards using the procedures and assumptions listed in [Table 5.7](#) presented for splashblock downspout dispersion in [Table 5.4](#) (refer to [Section 5.3.3.6](#)).

Table 5.7. Continuous Modeling Assumptions for Trench Downspout Dispersion.

Variable	Assumption
Precipitation Series	Seattle 2021 Precipitation Time Series
Computational Time Step	5 minutes
HSPF Parameters	LSUR, SLSUR, NSUR shall be adjusted per <i>Appendix F</i>
Flowpath Length	25 feet minimum
Flowpath Width	Width of the dispersion device (i.e., trench): 10 feet minimum
Flowpath Slope	Existing condition
Roof Area Dispersed	<p>Single Downspout (WWHM only): The connected roof area should be modeled as a lateral flow impervious area over the underlying soil type (e.g., till). The lateral flow elements in WWHM are available on the Mitigated Scenario screen. The lateral flow impervious area element (roof area) should be connected to the lawn/landscape lateral flow soil basin element (the vegetated flowpath).</p> <p>Multiple Downspouts (WWHM or MGSFlood): The roof area can be modeled as 50% landscaped (lawn in WWHM; grass in MGSFlood) and 50% impervious.</p>

Refer to [Section 5.1.6](#) for modeling amended soils to partially meet the flow control and/or water quality treatment requirement when runoff is dispersed on amended soil.

5.3.4.7. Minimum Construction Requirements

Protect the dispersion flowpath from sedimentation and compaction during construction. If the flowpath area is disturbed during construction, restore the area to meet the Soil Amendment BMP requirements in [Section 5.1](#) and establish a dense cover of lawn, landscape or groundcover. During construction confirm the dispersion trench surface is level (e.g., laser testing or flow test).

5.3.4.8. Operations and Maintenance Requirements

Trench downspout dispersion O&M requirements are provided in [Appendix G](#) (BMP No. [2524](#)).

5.3.5. Sheet Flow Dispersion

5.3.5.1. Description

Sheet flow dispersion is one of the simplest methods of runoff control. This BMP can be used for any hard surface or pervious surface that is graded to avoid concentrating flows. Because flows are already dispersed as they leave the surface (i.e., not concentrated), they need only traverse a narrow band of adjacent vegetation for effective flow attenuation and treatment.

5.3.5.2. Performance Mechanisms

Sheet flow dispersion can provide flow control via flow attenuation, soil storage, and losses to infiltration, evaporation, and transpiration.

5.3.5.3. Applicability

Sheet flow dispersion can be designed to provide on-site stormwater management and flow control. This BMP can be applied to meet or partially meet the requirements listed below. If the designer implements a dispersion BMP to meet water quality treatment standards, the BMP shall be designed using the additional design requirements for filter strips per *Section 5.8.4*.

BMP	On-site		Flow Control			Water Quality				Conveyance
	List	Standard	Forest	Pasture	Peak	Basic	Enhanced	Oil Control	Phosphorus	
Sheet flow dispersion	✓	✓ ^a	✓ ^a	✓ ^a	✓ ^a	✓ ^b				

^a Standard may be partially or completely achieved depending upon underlying soil type.

^b Must Shall meet additional design requirements for vegetatedbasic filter strips (refer to *Section 5.8.4*) to fully meet the water quality treatment requirement.

5.3.5.4. Site Considerations

General site considerations for determining the feasibility of dispersion BMPs for a particular site are provided in *Section 5.3.1.1*. Sheet flow dispersion is applicable for hard surfaces with slopes less than 15 percent, such as sidewalks, driveways, sport courts, patios, roofs without gutters, or other situations where concentration of flows can be avoided. Refer to *Appendix C* for additional infeasibility criteria for the On-site List Approach.

5.3.5.5. Design Criteria

This section provides a description and requirements for the components of sheet flow dispersion. A typical plan for driveway sheet flow dispersion is shown in Figure 5.5. Design criteria are provided in this section for the following elements:

- Contributing area
- Transition zone
- Dispersion flowpath
- Overflow

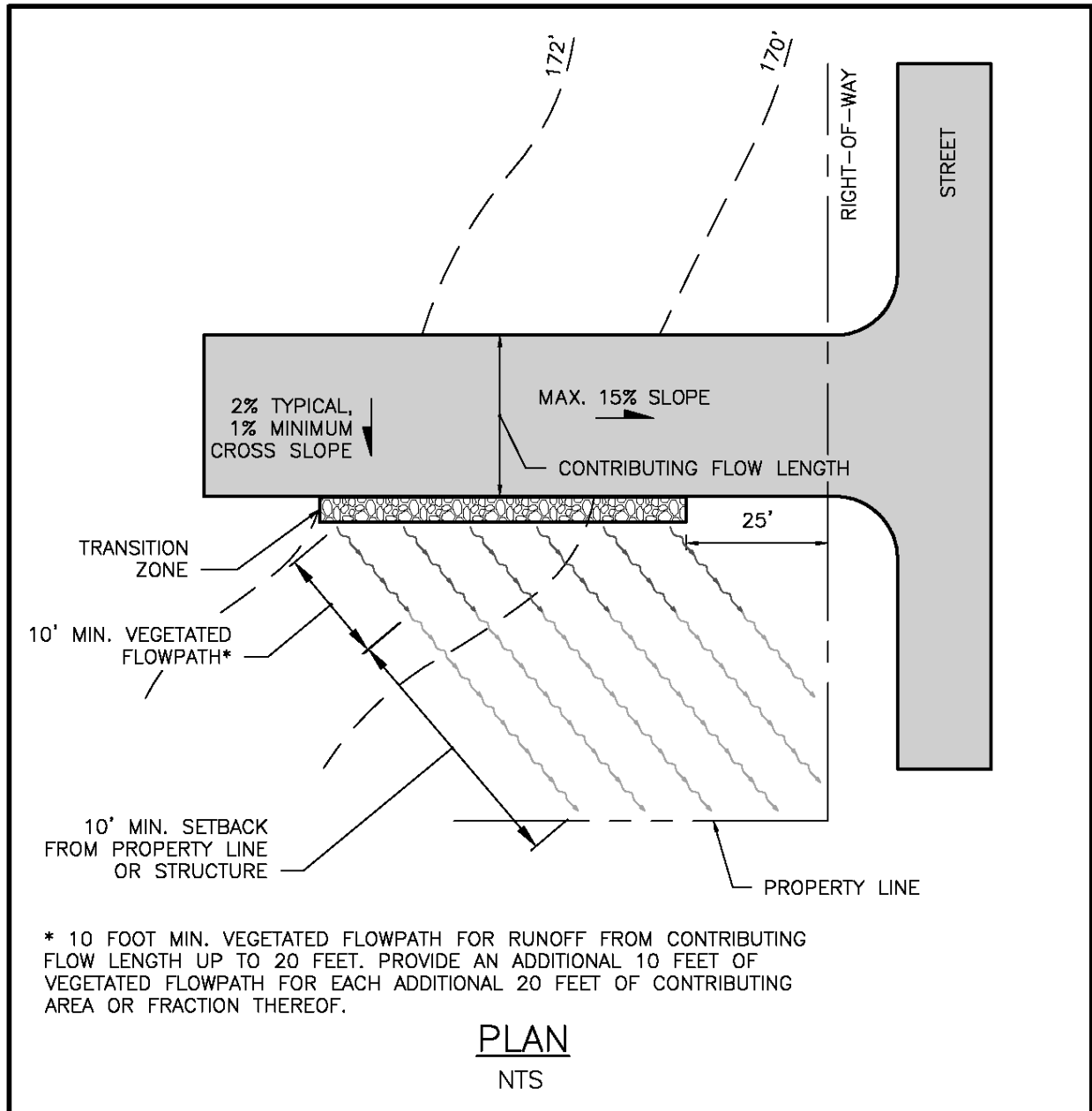

Figure 5.5. Typical Sheet Flow Dispersion for Flat and Moderately Sloping Driveways.

Contributing Area

The hard surface area contributing sheet flow to the dispersion flowpath shall have a slope less than 15 percent. The cross slope towards the transition zone shall be a minimum of 2 percent.

Transition Zone

A 2-foot-wide transition zone to discourage channeling shall be provided between the edge of the contributing hard surface area (or building eaves) and the downslope vegetation. This

may be an extension of subgrade material (crushed rock), modular pavement, drain rock, or other material approved by the Director.

Dispersion Flowpath

The general minimum requirements associated with the dispersion flowpath are provided in *Section 5.3.1.2*. An additional flowpath requirement specific to sheet flow dispersion is as follows:

- Provide a vegetated flowpath of 10 feet to disperse sheet flow runoff from hard surface with a contributing flow length of 20 feet. If the contributing hard surface is at least 50 percent permeable pavement, the contributing flow length may be increased from 20 to 25 feet. Provide an additional 10 linear feet of vegetated flowpath for each additional 20 linear feet of contributing flow length or fraction thereof.
- [The slope of the vegetated flowpath shall not exceed 15 percent.](#)
- Down gradient of the required flowpath (per the bullet above), an additional 10 feet shall be provided before the flowpath intersects a property line (excluding the property line abutting the right-of-way) or encounters a structure.

Overflow

Identify the overland flowpath for each dispersion point. Consider surface flows that may extend beyond the design flowpath length. Prevent flow from causing erosion or flooding on site or on adjacent properties ([refer to Section 4.3.3](#)).

5.3.5.6. BMP Credits

Credit for On-site List Approach

The hard surface area dispersed using sheet flow dispersion meets the On-site List Requirement (refer to *Section 3.3.1* and *Appendix C* for infeasibility criteria).

Pre-sized Approach for Flow Control

The Pre-sized Approach may be used for projects with new and replaced hard surface areas up to 10,000 square feet. Under the Pre-sized Approach (refer to *Section 4.1.2*), flow control credits may be achieved by using sheet flow dispersion. The credits provided in [Table 5.85-7](#) can be applied to reduce the hard surface area requiring flow control as explained for splashblock downspout dispersion.

Table 5.85-7. Pre-sized Flow Control Credits for Sheet Flow Dispersion.

Dispersion Type	Credit (%)	
	Pre-developed Pasture Standard	Peak Control Standard
Sheet Flow Dispersion	9474%	9476%

Hard Surface Area Managed = Hard Surface Area Dispersed x Credit (%) / 100.

Modeling Approach for On-site Performance Standard and Flow Control

Continuous hydrologic modeling may be used to quantify the performance of sheet flow dispersion relative to the on-site and flow control standards using the procedures and assumptions listed in Table [5.95-8](#).

Table 5.95-8. Continuous Modeling Assumptions for Sheet Flow Dispersion.

Variable	Assumption
Precipitation Series	Seattle 158-year, 5-minute series
Computational Time Step	5 minutes
HSPF Parameters	LSUR, SLSUR, NSUR shall be adjusted per Appendix F
Flowpath Length	10 feet minimum
Flowpath Width	Width of the dispersion device (i.e., sheet flow transition zone); 2 feet minimum
Flowpath Slope	Existing condition
Hard Surface Area Dispersed	<p>The hard surface area should be modeled as a lateral flow impervious area over the underlying soil type (e.g., till). In WWHM, this option is available on the Mitigated Scenario screen. The lateral flow impervious area element (representing the area that is dispersed) should be connected to the lawn/landscape lateral flow soil basin element (the vegetated flowpath). Option 1: Impervious area dispersed modeled as lawn over the underlying soil type (e.g., till). Existing slope condition of dispersion flowpath should be used.</p> <p>Option 2: Represent impervious runoff dispersion using the lateral flow routine (this option shall be used if contributing area includes a vegetated roof or permeable pavement). Modeled flowpath width shall no more than the width of the dispersion device (i.e., sheet flow transition zone).</p>

[Refer to Section 5.1.6 for modeling amended soils to partially meet the flow control and/or water quality treatment requirement when runoff is dispersed on amended soil.](#)

5.3.5.7. Minimum Construction Requirements

Protect the dispersion flowpath from sedimentation and compaction during construction. If the flowpath area is disturbed during construction, restore the area to meet the Soil Amendment BMP requirements in *Section 5.1* and establish a dense cover of lawn, landscape or groundcover.

5.3.5.8. Operations and Maintenance Requirements

Sheet flow dispersion O&M requirements are provided in *Appendix G (BMP No. 2524)*.

5.3.6. Concentrated Flow Dispersion

5.3.6.1. Description

Concentrated flow dispersion BMPs disperse concentrated flows from driveways or other pavement through a vegetated pervious area to provide flow control. In a typical application, sheet flow from a ground-level impervious surface is intercepted by a berm or slot drain and conveyed to a dispersion point (i.e., rock pad or dispersion trench).

5.3.6.2. Performance Mechanisms

Concentrated flow dispersion can provide flow control via attenuation, soil storage, and losses to infiltration, evaporation, and transpiration.

5.3.6.3. Applicability

Concentrated flow dispersion can be designed to provide on-site stormwater management and flow control. This BMP can be applied to meet or partially meet the requirements listed below. If the designer implements a dispersion BMP to meet water quality treatment standards, the BMP shall be designed using the additional design requirements for filter strips per *Section 5.8.4*.

BMP	On-site		Flow Control			Water Quality			Conveyance	
	List	Standard	Forest	Pasture	Peak	Basic	Enhanced	Oil Control		Phosphorus
Concentrated Flow Dispersion	✓	✓ ^a	✓ ^a	✓ ^a	✓ ^a	✓ ^b				

^a Standard may be partially or completely achieved depending upon underlying soil type.

^b ~~Must~~ Shall meet additional design requirements for vegetated~~basic~~ filter strips (refer to *Section 5.8.4*) to fully meet the water quality treatment requirement.

5.3.6.4. Site Considerations

General site considerations for determining the feasibility of dispersion BMPs for a particular site are provided in *Section 5.3.1.1*. Refer to *Appendix C* for additional infeasibility criteria for the On-site List Approach.

5.3.6.5. Design Criteria

This section provides a description and requirements for the components of concentrated flow dispersion. A typical plan for concentrated flow dispersion for steep driveways is shown in Figure 5.6. Design criteria are provided in this section for the following elements:

- Contributing area
- Berm or slotted drain
- Rock pad (dispersion device option 1)
- Downspout dispersion trench (dispersion device option 2)
- Dispersion flowpath

- Overflow

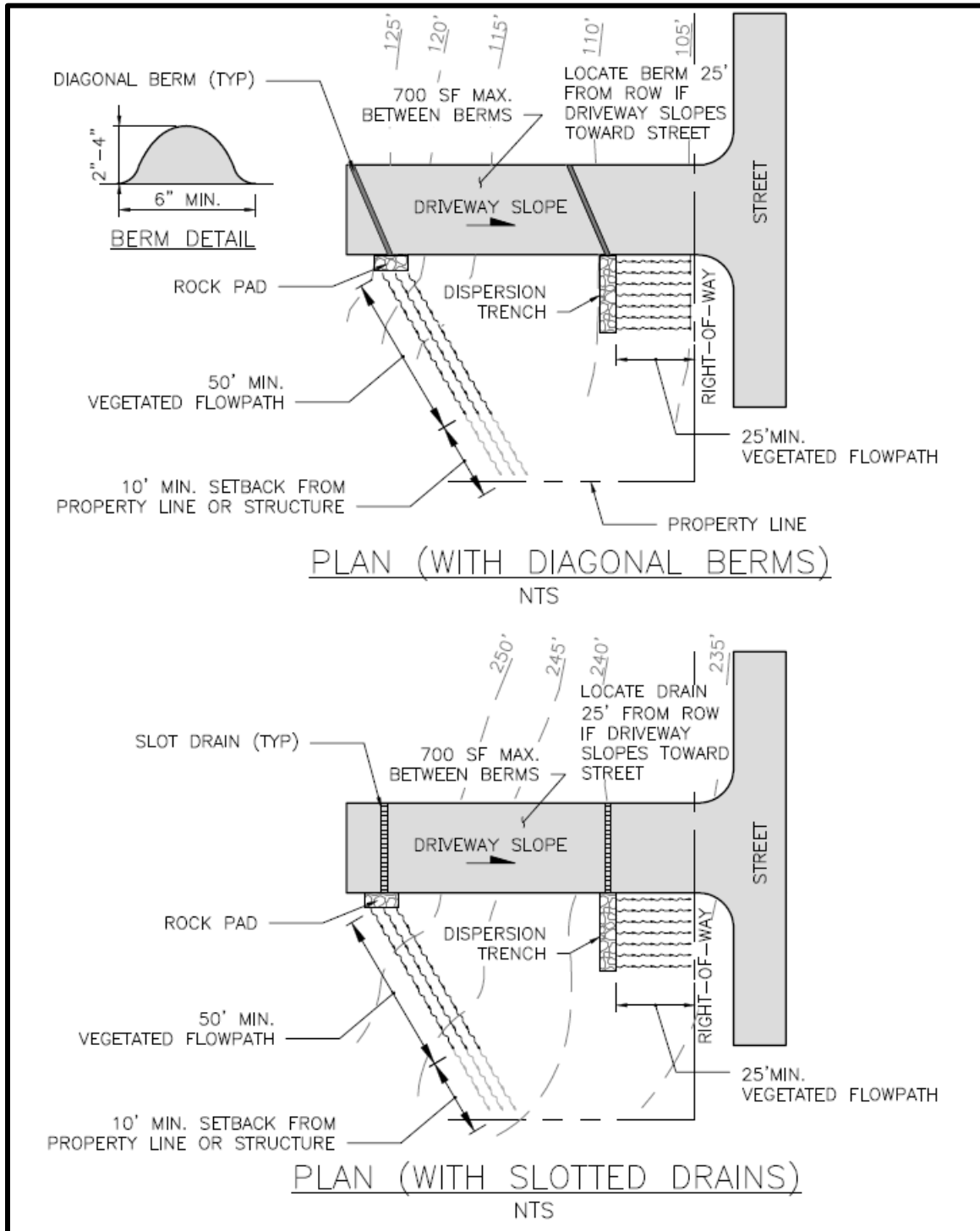

Figure 5.6. Typical Concentrated Flow Dispersion for Steep Driveways.

Contributing Area

A maximum of 700 square feet of impervious area may drain to each concentrated flow dispersion device (i.e., rock pad or dispersion trench). Larger contributing areas may be approved for other types of hard surfaces (e.g., permeable pavement). If at least 50 percent of the contributing area is permeable pavement, contributing areas up to 900 square feet will be allowed.

Berm or Slotted Drain

A slotted drain, diagonal berm, or similar measure shall be provided to direct flow to the rock pad or dispersion trench.

Rock Pad (if selected)

If selected as the dispersion device, a pad of crushed rock (2 feet wide by 3 feet long by 6 inches deep) shall be placed at the point of discharge. The downstream edge of rock pad shall be at least 5 feet from a structure. A 10-foot setback from a building with a basement is recommended. The rock pad shall have an impermeable liner within setback.

Dispersion Trench (if selected)

If selected as the dispersion device, the dispersion trench design shall meet the following minimum requirements:

- The trench shall be a minimum of 18 inches deep and 2 feet wide.
- The trench shall be level and aligned parallel to site elevation contours to disperse the water to the downslope flowpath. The trench shall be constructed to prevent point discharge and erosion.
- Trenches serving up to 700 square feet of impervious area shall be 10-foot-long. If the contributing area is not an impervious surface (e.g., permeable pavement), contributing areas larger than 700 square feet may be approved for a 10-foot trench. If at least 50 percent of the contributing area is permeable pavement, contributing areas up to 900 square feet will be allowed for a 10-foot trench. For contributing areas greater than the contributing areas noted above, the trench length shall be calculated as a minimum of 10 feet plus a proportional trench length based on the additional contributing area. For example, trench length for trenches serving non-permeable pavement areas larger than 700 square feet shall be calculated as: $\text{Total roof area in square feet} \times 10 \text{ feet} \div 700 \text{ square feet}$.
- A setback of at least 5 feet shall be maintained between any edge of the trench and any structure or property line. A 10-foot setback from a building with a basement is recommended.

Dispersion Flowpath

The minimum requirements for the dispersion flowpath are listed below:

- For rock pads, a vegetated flowpath of at least 50 feet shall be provided between the dispersion device any ~~slope over 15 percent~~, stream, wetland, lake, ~~or other~~ hard

surface, [or slope over 15 percent](#),. Critical area buffers may count toward flowpath lengths. The flowpath length is measured perpendicular to site contours.

- [For dispersion trenches, a vegetated flowpath of at least 25 feet shall be provided between the outlet of the trench and any property line, slope over 15 percent, stream, wetland, lake, structure, or other hard surface. Critical area buffers may count toward flowpath lengths. The flowpath length is measured perpendicular to site contours.](#)
- [The slope of the vegetated flowpath shall not exceed 15 percent.](#)
- Down gradient of the required flowpath (per the bullets above), an additional 10 feet shall be provided before the flowpath intersects a property line (excluding the property line abutting the right-of-way) or encounters a structure.
- The first 25 feet of the dispersion flowpath shall be at least 5 feet from any structure or property line.
- Each dispersion device shall have a separate flowpath. For the purpose of maintaining adequate separation of flows discharged from adjacent dispersion devices, vegetated flowpaths shall be at least 20 feet apart at the upslope end and shall not overlap with other flowpaths at any point along the flowpath lengths.
- For the purpose of measuring setbacks to structures, property lines, and other flowpaths, the following shall be assumed:
 - The rock pad flowpath width shall be assumed to be 3 feet extending from the center line of the rock pad
 - The dispersion trench flowpath width shall be assumed to be the length of the dispersion trench.
 - Setbacks shall be measured from the edge of the assumed flowpath.

Overflow

Identify the overland flowpath for each dispersion point. Consider surface flows that may extend beyond the design flowpath length. Prevent flow from causing erosion or flooding on site or on adjacent properties [\(refer to Section 4.3.3\)](#).

5.3.6.6. *BMP Credits*

Credit for On-site List Approach

The hard surface area dispersed using concentrated dispersion meets the On-site List Requirement (refer to *Section 3.3.1* and *Appendix C* for infeasibility criteria).

Pre-sized Approach for Flow Control

The Pre-sized Approach may be used for projects with new and replaced hard surface areas up to 10,000 square feet. Under the Pre-sized Approach (refer to *Section 4.1.2*), flow control credits may be achieved by using concentrated flow dispersion. The credits provided in [Table 5.9-10](#) can be applied to reduce the hard surface area requiring flow control as explained for splashblock downspout dispersion.

Table 5.910. Pre-sized Flow Control Credits for Concentrated Flow Dispersion.

Dispersion Type	Credit (%)	
	Pre-developed Pasture Standard	Peak Control Standard
Concentrated Flow Dispersion	9474%	9476%

Hard Surface Area Managed = Hard Surface Area Dispersed x Credit (%) / 100.

Modeling Approach for On-site Performance Standard and Flow Control

Continuous hydrologic modeling may be used to quantify the performance of concentrated flow dispersion relative to the on-site and flow control performance standards using the procedures and assumptions listed in Table 5.110.

Table 5.110. Continuous Modeling Assumptions for Concentrated Flow Dispersion.

Variable	Assumption
Precipitation Series	Seattle 158-year, 5-minute series
Computational Time Step	5 minutes
HSPF Parameters	LSUR, SLSUR, NSUR shall be adjusted per <i>Appendix F</i>
Flowpath Length	25 feet minimum
Flowpath Width	6 feet for dispersion points (i.e., splashblocks or rock pads) or the width of the dispersion device (i.e., trench)
Flowpath Slope	Existing condition
Hard Surface Area Dispersed	<p><u>Single Downspout or Area Option 1:</u> The hard surface area should be modeled as a lateral flow impervious area over the underlying soil type (e.g., till). The lateral flow elements in WWHM are available on the Mitigated Scenario screen. The lateral flow impervious area element (representing the area that is dispersed) should be connected to the lawn/landscape lateral flow soil basin element (the vegetated flowpath). Impervious area dispersed modeled as lawn over the underlying soil type (e.g., till). Existing slope condition of dispersion flowpath should be used.</p> <p><u>Multiple Downspouts (Option 12):</u> In situations where multiple downspout dispersions will occur, a pad of crushed rock or dispersion trenches are used, and the flowpath is at least 50 feet, the hard surface area can be modeled as 100% landscaped (lawn in WWHM; grass in MGSFlood). Represent impervious runoff dispersion using the lateral flow routine. (this option shall be used if contributing area includes permeable pavement). Modeled flowpath width shall be no more than 6 feet for dispersion points (i.e., splashblocks or rock pads) or the width of the dispersion device (i.e., trench).</p> <p><u>Multiple Downspouts (Option 2):</u> In situations where multiple downspout dispersions will occur, dispersion trenches are used, and the flowpath is at 25 to 50 feet, the hard surface area can be modeled as 50% landscaped (lawn in WWHM; grass in MGSFlood) and 50% impervious.</p>

Refer to [Section 5.1.6](#) for modeling amended soils to partially meet the flow control and/or water quality treatment requirement when runoff is dispersed on amended soil.

5.3.6.7. Minimum Construction Requirements

Protect the concentrated flow dispersion flowpath from sedimentation and compaction during construction. If the flowpath area is disturbed during construction, restore the area to meet the Soil Amendment BMP requirements in [Section 5.1](#) and establish a dense cover of lawn,

landscape or groundcover. If a dispersion trench is used, confirm the trench surface is level (e.g., laser testing or flow test).

5.3.6.8. Operations and Maintenance Requirements

Concentrated flow dispersion O&M requirements are provided in *Appendix G (BMP No. [2524](#))*.

5.3.7. Sidewalk/Trail Compost-Amended Strip

5.3.7.1. Description

The sidewalk/trail compost-amended strip consists of a compost-amended, vegetated strip (amended per [Section 5.1 Soil Amendment BMP](#)) located continuously adjacent to a sidewalk or trail hard surface to be mitigated. The BMP provides runoff mitigation for sheet flow from an adjacent sidewalk or trail through infiltration and evapotranspiration.

5.3.7.2. Performance Mechanisms

Sidewalk/trail compost-amended strips can provide flow control via flow attenuation, soil storage, and losses to infiltration, evaporation, and transpiration.

5.3.7.3. Applicability

Sidewalk/trail compost-amended strips are designed to meet both the On-site List Approach using the provided sizing factors and the On-site Performance Approach, using the modeling assumptions provided in [Section 5.3.7.6](#). Sidewalk/trail compost-amended strips may be constructed in conjunction with other stormwater BMPs to achieve mitigation requirements other than On-site Stormwater Management. When the sidewalk/trail compost-amended strip is used to help meet flow control or water quality treatment requirements, the designer shall prove performance by explicit simulation with an approved continuous simulation model.

BMP	On-site		Flow Control			Water Quality			Conveyance	
	List	Standard	Forest	Pasture	Peak	Basic	Enhanced	Oil Control		Phosphorus
Sidewalk/trail compost-amended strip	✓	✓	✓ ^a	✓ ^a	✓ ^a	✓ ^b	✓ ^c			

^a Standard may be partially achieved.

^b Shall meet additional design requirements for vegetated filter strips (refer to [Section 5.8.4](#)) to fully meet the water quality treatment requirement.

^c Shall meet additional design requirements for CAVFS (refer to [Section 5.8.4](#)) to fully meet the water quality treatment requirement.

5.3.7.4. Site Considerations

The sidewalk/trail compost-amended strip is applicable for pedestrian and multi-use trails and sidewalks. The target surface may consist of any hard surface (e.g., concrete, asphalt, and compacted gravel) that does not exceed the specified widths or longitudinal and lateral slopes. Likewise, the BMP location adjacent to the target surface shall not be overly steep, shall be compost-amended, and vegetated. Vegetation shall be dense and healthy, but specific vegetation is left to the designer (e.g., turf or dense ground cover). Shrubs and trees are acceptable in addition to the turf or dense ground cover. Refer to [Appendix C](#) for additional infeasibility criteria for the On-site List Approach.

The sidewalk/trail compost-amended strip follows minimum requirements similar to those associated with dispersion and infiltration BMPs. To reduce the potential for concentrated flow entering the BMP, the sidewalk/trail compost-amended strip can only be used where the tributary sidewalk and trail lateral (perpendicular to the edge of hard surface adjacent to the BMP) slopes are not less than 1 percent and not greater than 5 percent, and the longitudinal slope is not greater than 8 percent. (Note that ADA requirements for sidewalk slopes will typically be even more limiting.) In addition, the contributing hard surface may not exceed 25 feet in width.

The sidewalk/trail compost-amended strip shall also be located immediately adjacent to the trail or sidewalk surface to be mitigated and have a slope not greater than 25 percent (i.e., 4 horizontal to 1 vertical) and not less than 2 percent.

The sidewalk/trail compost-amended strip design is based on the native soil design infiltration rate, as determined by site-specific testing and applied long-term infiltration rate safety factors. If no native soil infiltration testing is conducted, the designer shall assume a design infiltration rate of 0.15 inch per hour.

5.3.7.5. Design Criteria

This section provides a description and requirements for the components of sidewalk/trail compost-amended strips. Typical components for sidewalk/trail compost-amended strips are shown in Figure 5.7. Design criteria are provided in this section for the following elements:

- Contributing area
- Level spreader
- Compost-amended strip
- Overflow

Contributing Area

The width of the contributing area is measured perpendicular to the edge of pavement adjacent to the BMP and shall not exceed 25 feet.

Sidewalk/trail compost-amended strips allow for run-on of non-sidewalk/trail surfaces not greater than 10 percent of the sidewalk and trail area. The contributing area widths used to determine the sizing factor shall account for any run-on surface area.

Level Spreader

Sidewalks/trails with a width greater than or equal to 10 feet require a level spreader to help ensure even distribution of flow entering the sidewalk/trail compost-amended strip. The level spreader shall consist of vegetated compost-amended soil (refer to *Section 5.1*) and shall be 1-foot wide, as measured perpendicular to the edge of hard surface adjacent to the BMP. The level spreader lateral (i.e., between the hard surface and sidewalk/trail compost-amended strip) slope shall be 2 percent or less. The top of the level spreader shall be lower than the adjacent sidewalk/trail surface by at least 1 inch. The level spreader width (1 foot) can be included as part of the total required sidewalk/trail compost-amended strip width.

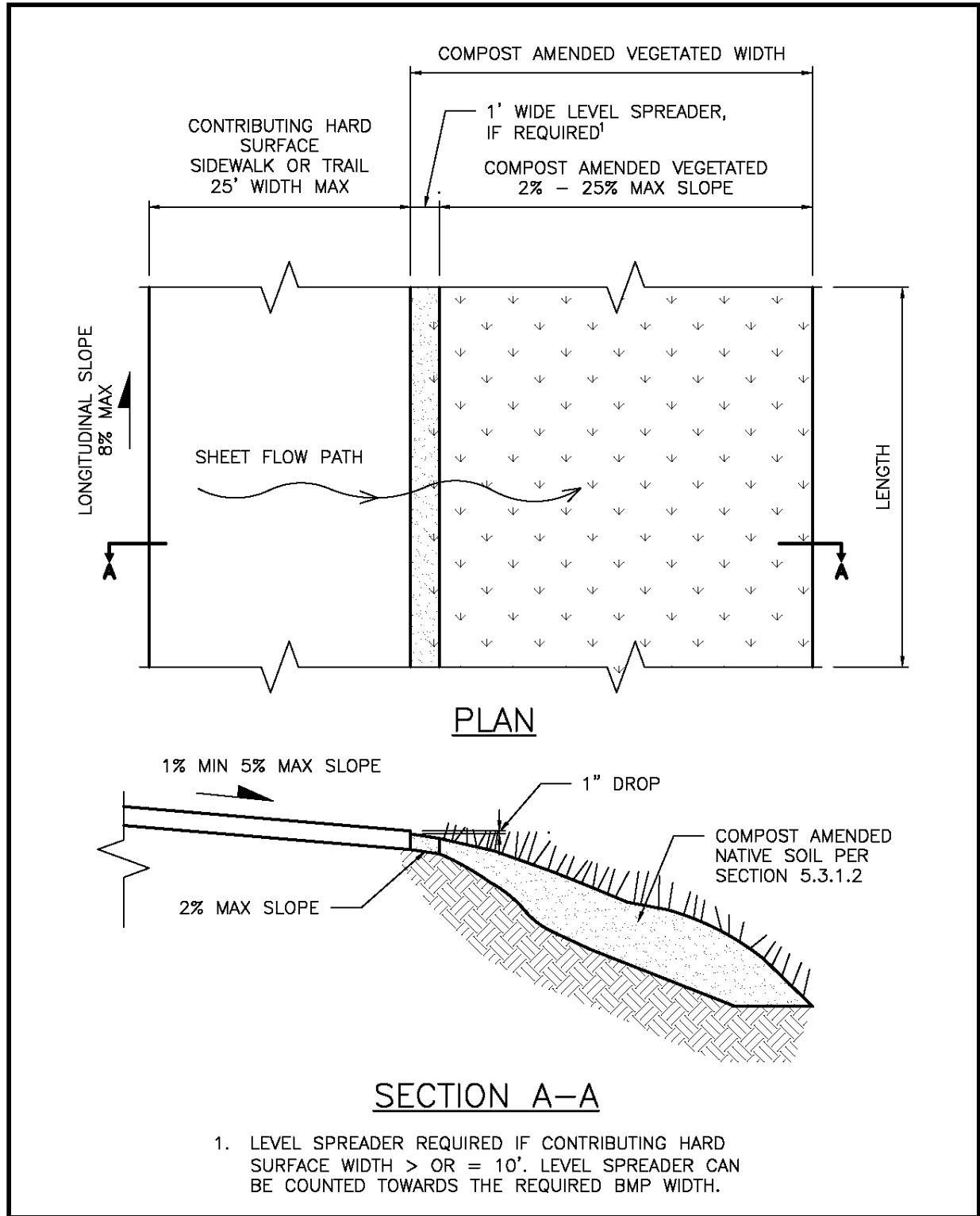

Figure 5.7. Typical Sidewalk/Trail Compost-Amended Strip BMP.

Compost-Amended Strip

The general minimum requirements associated with the flowpath to the sidewalk/trail compost-amended strip are provided in Section 5.3.1.2. Additional flowpath requirements specific to sidewalk/trail compost-amended strips are as follows:

- The total sidewalk/trail compost-amended strip width may not be less than 1 foot.
- The lateral slope of the sidewalk/trail compost-amended strip shall not be less than 2 percent nor greater than 25 percent.
- The sidewalk/trail compost-amended strip shall be amended (refer to Section 5.1) and vegetated. Vegetation shall be dense and healthy, but specific vegetation is left to the designer (e.g., turf or dense ground cover). Shrubs and trees are acceptable in addition to the turf or dense ground cover.
- The width of the BMP is measured perpendicular to the edge of adjacent hard surface.

Overflow

The overflow flowpath downstream of the sidewalk/trail compost-amended strip shall be identified, and surface flows that may extend beyond the sidewalk/trail compost-amended strip shall be considered. Sidewalk/trail compost-amended strip design and site design shall prevent overflow from the sidewalk/trail compost-amended strip from causing erosion or flooding on site or on adjacent properties. Overland flowpath shall be vegetated and a minimum of 10 feet long prior to intersecting a building or property line (excluding right-of-way line).

5.3.7.6. BMP Sizing

The sidewalk/trail compost-amended strip width may be determined using the sizing factor approach for the On-Site Standard by providing the specified ratio of BMP width to the width of the contributing area. Alternatively, explicit simulation of the sidewalk/trail composted amended strip may be used to size the appropriate strip width for the contributing area.

Sizing Factors for On-site List Approach

Sidewalk/trail compost-amended strips may be sized using the sizing factors provided in Table 5.12 to meet the On-site List Approach. Sizing factors are presented as a ratio of hard surface width to sidewalk/trail compost-amended strip width. Sidewalk/trail compost-amended strip width is calculated by multiplying the width of hard surface contributing runoff by the sizing factor.

Refer to Section 3.3.1 and Appendix C for infeasibility criteria to determine sidewalk/trail compost-amended strip infeasibility.

Table 5.12. On-site List Sizing for Sidewalk/Trail Compost-Amended Strips.

Sidewalk/Trail Hard Surface Width	Subgrade Soil Design Infiltration Rate^a	Sizing Factor for Strip Width^{b,c}
Less than 10 feet	0.15 inch/hour	42%
	0.3 inch/hour	29%
	0.6 inch/hour	21%
Greater than or equal to 10 feet ^d	0.15 inch/hour	33%
	0.3 inch/hour	21%
	0.6 inch/hour and greater	13%

^a The subgrade soil design infiltration rate is based on site-specific infiltration rate measurement and safety factors as detailed in [Section 3.2](#) and [Appendix D](#).

^b The sizing factors meet both the Forested and Pasture On-site Performance Standard requirement.

^c Total BMP width (level spreader, if required, plus compost-amended strip) shall not be less than 1 foot. BMP width is measured perpendicular to the adjacent edge of hard surface.

^d A 1-foot-wide level spreader adjacent to the sidewalk or trail is required for sidewalk or trail widths greater than or equal to 10 feet. The 1-foot length of the level spreader can be counted towards the required BMP width determined in the table.

Modeling Approach for On-site Performance Standard

Sidewalk/trail compost-amended strips can also be sized using the forested and pasture On-site Performance Standard. Continuous runoff hydrologic modeling using the CAVFS element in WWHM may be used to quantify the performance of sidewalk/trail compost-amended strips relative to the On-site Performance Standard using the procedures and assumptions listed in [Table 5.13](#). Modeling in MGSFlood is not currently allowed for this BMP.

Table 5.13. Continuous Modeling Assumptions for Sidewalk/Trail Compost-Amended Strips.

Variable	Assumption
Precipitation Series	Seattle 2021 Precipitation Time Series
Computational Time Step	5 minutes
HSPF Parameters	LSUR, SLSUR, NSUR shall be adjusted per Appendix E
Precipitation and Evaporation Applied to BMP	Yes
Minimum Pervious Strip Depth	8 inches
Embankment Height	Dependent on width of BMP. BMP surface slope shall not exceed 25 percent or be less than 2 percent.
Compost-Amended Strip Slope	Shall not exceed 25 percent or be less than 2 percent.
Maximum Water Depth	1 inch
Compost-Amended Soil Hydraulic Conductivity	1 inch per hour
Compost-Amended Soil Porosity	30 percent
Subgrade Soil Design Infiltration Rate	Design infiltration rate (Section 3.2 and Appendix D). If no testing is conducted, assume an infiltration rate of 0.15 inch per hour.

Refer to [Section 5.1.6](#) for modeling amended soils to partially meet the flow control and/or water quality treatment requirement when runoff is dispersed on amended soil.

5.3.7.7. Minimum Construction Requirements

Protect the flowpath from sedimentation and compaction during construction. If the flowpath area is disturbed during construction, restore the area to meet the Soil Amendment BMP requirements (refer to Section 5.1) and establish a dense cover of lawn, landscape, or groundcover.

5.3.7.8. Operation and Maintenance Requirements

O&M requirements for sidewalk/trail compost-amended strips are the same as the Filter Strip (Basic and CAVFS) O&M requirements provided in Appendix G (BMP No. 11).

5.4. Infiltration BMPs

Infiltration BMPs are designed to facilitate percolation of stormwater into the ground. The infiltration BMPs in this section include:

- Infiltration trenches (*Section 5.4.2*)
- Drywells (*Section 5.4.3*)
- Infiltrating bioretention (*Section 5.4.4*)
- Rain gardens (*Section 5.4.5*)
- Permeable pavement facilities (*Section 5.4.6*)
- Perforated stub-out connections (*Section 5.4.7*)
- Infiltration basins (*Section 5.4.8*)
- Infiltration chambers/[vaults](#) (*Section 5.4.9*)

Infiltration, where appropriate, is the preferred method for stormwater management because it attempts to restore the pre-development flow regime. Due to the geologic and topographic conditions in Seattle, not all sites are suitable for stormwater infiltration. The use of infiltration practices may be limited in some areas due to topography and potential landslide hazards. In addition, many locations in Seattle have soils that are underlain by hydraulically-restrictive materials (refer to *Appendix D, Section D-2.2.4*). These relatively impervious layers may limit or preclude infiltration by causing perched groundwater conditions during the wet season.

5.4.1. General Considerations for Infiltration BMPs

This section provides general requirements that are common to all infiltration BMPs included in this manual. Additional requirements specific to the different types of infiltration BMPs are provided in *Section 5.4.2* through *5.4.9*.

Note that permeable pavement surfaces (*Section 5.6.2*) are not considered infiltration BMPs for the purpose of this manual because they do not receive significant (greater than 10 percent) runoff from other areas and manage only the rain falling on the pavement surface. Although stormwater will infiltrate into the underlying soil, the volume infiltrated is similar to that infiltrated on vegetated permeable surfaces and do not necessitate the restrictions set forth in this section. Similarly, dispersion BMPs (*Section 5.3*) are not considered infiltration BMPs for the purposes of this manual. Although stormwater will infiltrate into the underlying soil, the stormwater is dispersed across a large area (subject to setbacks) making many of the restrictions set forth in this section unnecessary. The specific restrictions and setbacks that are applicable to permeable pavement surfaces and dispersion BMPs are provided in their respective sections in *Chapter 5* of this volume. An exception is that infiltration testing is required for permeable pavement surfaces when hydrologic modeling will be conducted to evaluate performance relative to the flow control, water quality treatment, or the On-Site Performance Standard. Infiltration testing may also be used to demonstrate that permeable pavement surfaces are not feasible for the On-site List.

In addition to shallow infiltration BMPs, *Appendix D* also covers provisions for deep infiltration BMPs, which may include Underground Injection Control (UIC) wells. Deep infiltration BMPs are typically used to direct stormwater past surface soil layers that have lower infiltration rates and into well-draining soil. The depth of the soil layers with lower infiltration rates can vary significantly, so the technique required to reach the well-draining soils will also vary.

~~According to Washington Administrative Code (WAC 173-218-030), a UIC well is defined as “a well that is used to discharge fluids into the subsurface. A UIC well is one of the following: (1) A bored, drilled or driven shaft, or dug hole whose depth is greater than the largest surface dimension; (2) an improved sinkhole; or (3) a subsurface fluid distribution system.” UIC well systems meeting the above criteria may include drywells, pipe or French drains, drain fields, and other similar devices that are used to discharge stormwater directly into the ground. Infiltration trenches with perforated or slotted pipe used to disperse and inject flows may also be considered to be UIC wells.~~

UIC wells are regulated by Ecology and the UIC Program (WAC 173-218). If UIC wells are considered, refer to ~~Volume I, Chapter 4 of the SWMMWW (Ecology 2019) for requirements, including *Guidance for UIC Wells that Manage Stormwater* (Ecology 2006). Information on the UIC program can also be found on~~ Refer to Ecology’s website for updates and revisions: <https://ecology.wa.gov/Regulations-Permits/Guidance-technical-assistance/Underground-injection-control-program> www.ecy.wa.gov/programs/wq/grndwtr/uic/.

The person responsible for the infiltration facility (i.e., the property owner for private systems) shall determine whether the facility is a regulated UIC well and what requirements apply. ~~Refer to Ecology’s UIC program for UIC well requirements.~~

Ecology SWMMWW Language	References
<p><u>The UIC program defines a UIC well as a well that is used to discharge fluids from the ground surface into the subsurface and is one of the following:</u></p> <ul style="list-style-type: none"> ● <u>A bored, drilled or driven shaft, or dug hole whose depth is greater than the largest surface dimension; or</u> ● <u>A dug hole whose depth is greater than the largest surface dimension, or</u> ● <u>An improved sinkhole; which is a natural crevice that has been modified, or</u> ● <u>A subsurface fluid distribution system which includes perforated pipes, drain tiles or other similar mechanisms intended to distribute fluids below the surface of the ground.</u> 	<ul style="list-style-type: none"> ● <u>Volume I, Chapter 2, Section 1-2.14 of the SWMMWW (Ecology 2019)</u>
<p><u>Examples of UIC wells or subsurface infiltration systems are the following:</u></p> <ul style="list-style-type: none"> ● <u>Drywells</u> ● <u>Drain fields</u> ● <u>Infiltration trenches with perforated [or slotted] pipe</u> ● <u>Storm chamber systems with the intent to infiltrate</u> ● <u>French drains</u> ● <u>Bioretention systems intending to infiltrate water from a [slotted] pipe below the treatment soil</u> ● <u>Other similar devices that discharge to ground</u> <p><u>Note: Modifications from the SWMMWW are shown in brackets for design criteria specific to the City of Seattle.</u></p>	<ul style="list-style-type: none"> ● <u>Volume I, Chapter 2, Section 1-2.14 of the SWMMWW (Ecology 2019)</u>

5.4.2. Infiltration Trenches

5.4.2.1. Description

Infiltration trenches are trenches backfilled with a coarse aggregate. Stormwater runoff can enter the trench as overland surface flow through a grate or exposed aggregate surface, or as concentrated flow delivered to the aggregate-filled trench using a perforated or slotted distribution pipe.

Infiltration trenches are subject to state UIC regulations when perforated pipe is used. Provided that the design and O&M criteria in this section are met, only the registration requirement applies. Where perforated pipe is not used, the registration requirement does not apply.

Ecology SWMMWW Language	References
<u>All UIC wells must be registered except: UIC wells at single-family homes (or duplexes) receiving only residential roof runoff used to collect stormwater runoff from roof surfaces on an individual home (or duplex) or for basement flooding control.</u>	<ul style="list-style-type: none"> <u>Volume I, Chapter 4, Section 1-4.3 of the SWMMWW (Ecology 2019)</u>
<p><u>The following are not UIC wells:</u></p> <ul style="list-style-type: none"> <u>Infiltration trenches designed without perforated pipe or a similar mechanism</u> 	<ul style="list-style-type: none"> <u>Volume I, Chapter 2, Section 1-2.14 of the SWMMWW (Ecology 2019)</u>

5.4.2.2. Performance Mechanisms

Flow control occurs through temporary storage of stormwater runoff in the spatial voids of the aggregate material and subsequent infiltration of stormwater into the underlying soils. Pollutant removal mechanisms include infiltration, filtration, adsorption, and biodegradation.

5.4.2.3. Applicability

An infiltration trench can be designed to provide on-site stormwater management, flow control and/or water quality treatment. This BMP can be applied to meet the requirements listed below.

BMP	On-site		Flow Control			Water Quality				Conveyance
	List	Standard	Forest	Pasture	Peak	Basic	Enhanced	Oil Control	Phosphorus	
Infiltration Trenches	✓ ^a	✓ ^a	✓ ^a	✓ ^a	✓ ^a	✓ ^{a, b}	✓ ^{a, b}		✓ ^{a, c}	

^a Infiltration trenches are only applicable where the site measured infiltration rate is at least 5 inches per hour. PGHS or PGPS may only be directed to infiltration trenches if the soil suitability criteria for the subgrade soils is met (*Section 4.5.2*).

^b Soil suitability criteria for subgrade soils (*Section 4.5.2*) and applicable drawdown requirements (*Section 4.5.1*) also apply.

^c Refer to treatment train options for infiltration BMPs included in *Section 4.4.3.2*.

5.4.2.4. *Site Considerations*

Site considerations for the applicability of infiltration trenches are provided in *Section 3.2* and *Section 4.5*. Refer to *Appendix C* for additional infeasibility criteria for the On-site List Approach.

5.4.2.5. *Design Criteria*

This section provides a description and requirements for the components of infiltration trenches. Refer to Figures [5.85-7](#) and [5.95-8](#) for schematics of typical infiltration trenches. Design criteria are provided in this section for the following elements:

- Trench dimensions and layout
- Aggregate material
- Geotextile
- Subgrade
- Flow entrance and presettling
- Perforated pipe
- Observation port
- Overflow

Trench Dimensions and Layout

The minimum requirements associated with the trench dimensions and layout include the following:

- The minimum depth of an infiltration trench shall be 18 inches.
- The minimum width of an infiltration trench shall be 24 inches. Sides of adjacent trenches shall be a minimum of 5 feet apart. [There is no maximum trench width.](#)
- The bottom of the trench shall be level.

To maximize the storage depth in the trench, the trench should be oriented parallel to site contour lines. The trench can be placed under a pervious or impervious surface cover to conserve space.

Aggregate Material

Trenches shall be filled with uniformly-graded, washed gravel with a nominal size from 0.75- to 1.5-inch diameter. The minimum void volume shall be 30 percent. These requirements can be met with City of Seattle Mineral Aggregate Type 4.

Geotextile

Non-woven geotextile fabric, according to the specifications presented in *Appendix E*, shall completely surround the aggregate material. A 6-inch minimum layer of sand may be used as a filter media instead of geotextile at the bottom of the trench, but geotextile is still required on the sides and top of the aggregate material.

Subgrade

The minimum measured subgrade infiltration rate for infiltration trenches is 5 inches per hour. If infiltration trenches are to be used to meet the water quality treatment requirement or if runoff from any PGHS is directed to the infiltration trench, underlying soil shall meet the soil requirements outlined in *Section 4.5.2*.

During construction the subgrade soil surface can become smeared and sealed by excavation equipment. The design shall require scarification or raking of the side walls and bottom of the facility excavation to a minimum depth of 4 inches after excavation to restore infiltration rate.

Flow Entrance and Presettling

Trenches designed to receive concentrated stormwater flows (refer to Figure [5.85-7](#)) shall include a small catch basin ~~or yard drain~~ with downturned elbow (trap). Presettling requirements are provided in *Section 4.4.5*.

For trenches designed to receive sheet flow (refer to Figure [5.95-8](#)), the site shall be graded so that runoff is directed as sheet flow across a minimum 10-foot grass buffer strip to remove larger sediment particles prior to runoff entering the trench. Six inches of gravel shall be placed over the geotextile covering the trench aggregate to allow flows to enter the trench.

Perforated Pipe

Concentrated flows shall be distributed into the aggregate material using a perforated or slotted subsurface pipe with a minimum diameter of 4 inches.

Observation Port

Infiltration trenches that are designed to meet flow control and/or water quality treatment requirements and receive runoff from contributing areas of 2,000 square feet or more shall be equipped with an observation port to measure the drawdown time following a storm and to monitor sedimentation to determine maintenance needs. Observation ports shall consist of a 4-inch minimum diameter perforated or slotted pipe that extends to the bottom of the trench (i.e., to the subgrade) and is equipped with a secure well cap.

Overflow

Trenches shall have an overflow designed to convey any flow exceeding the capacity of the facility [unless designed to fully infiltrate all flows for the full, required simulation period. Plans shall indicate surface flow paths in case of failure of the BMP \(refer to Section 4.3.3\). per Section 4.3.4.](#) If overflow is connected to the public drainage system [with a pipe](#), a catch basin shall be installed prior to the connection to the public drainage system to prevent root intrusion into public drainage main lines.

To prevent damage to overlying pavement, trenches located beneath pavement shall be constructed with a trench pipe overflow connected to a ~~small yard drain or~~ catch basin with a grate cover. Design shall be such that, if the trench infiltration capacity is exceeded, the trench pipe overflow would occur out of the catch basin to an approved point of discharge. The vertical elevation difference between the pavement surface and the trench pipe overflow invert shall be 1 foot minimum.

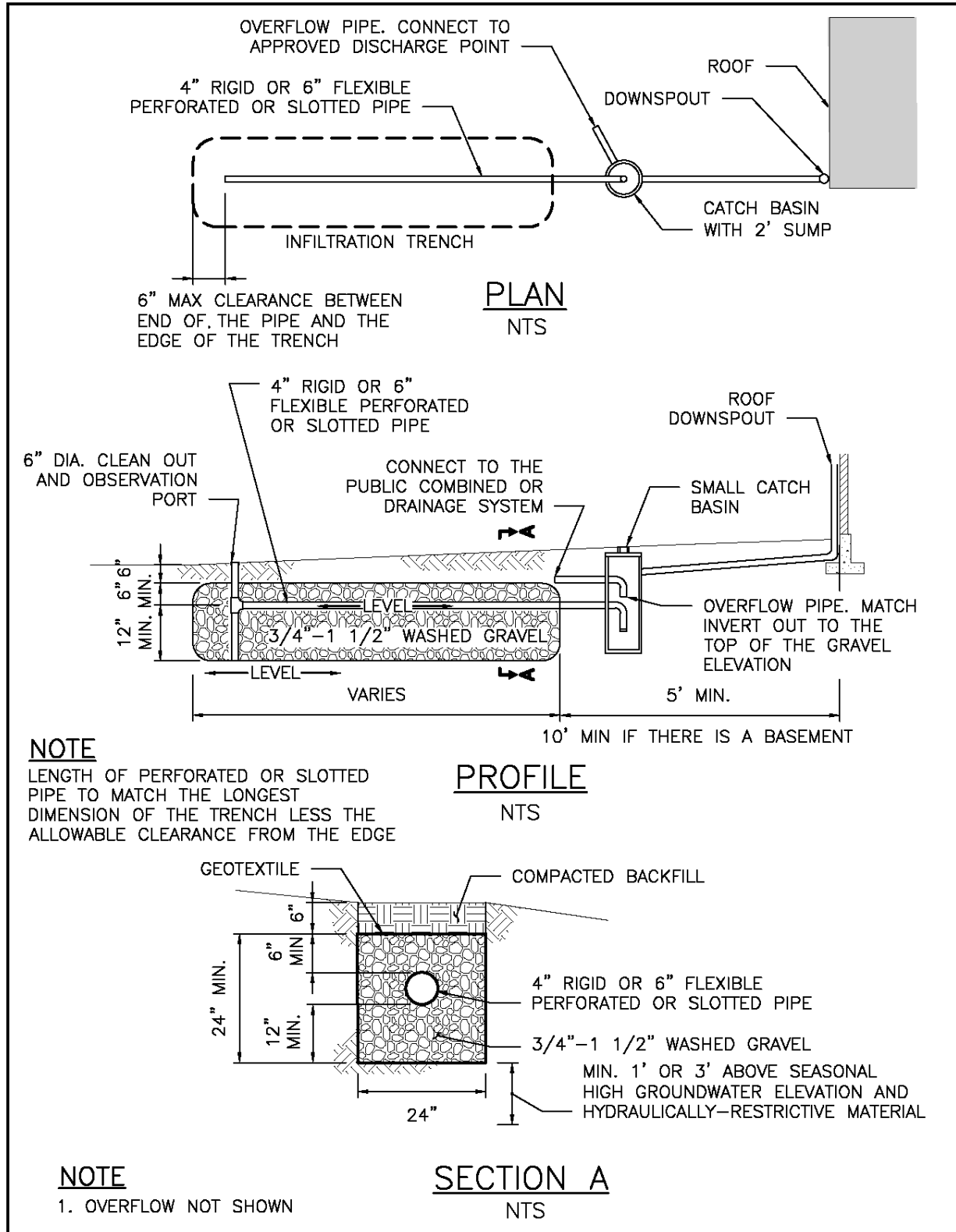

Figure 5.85-7. Typical Infiltration Trench Receiving Concentrated Flow.

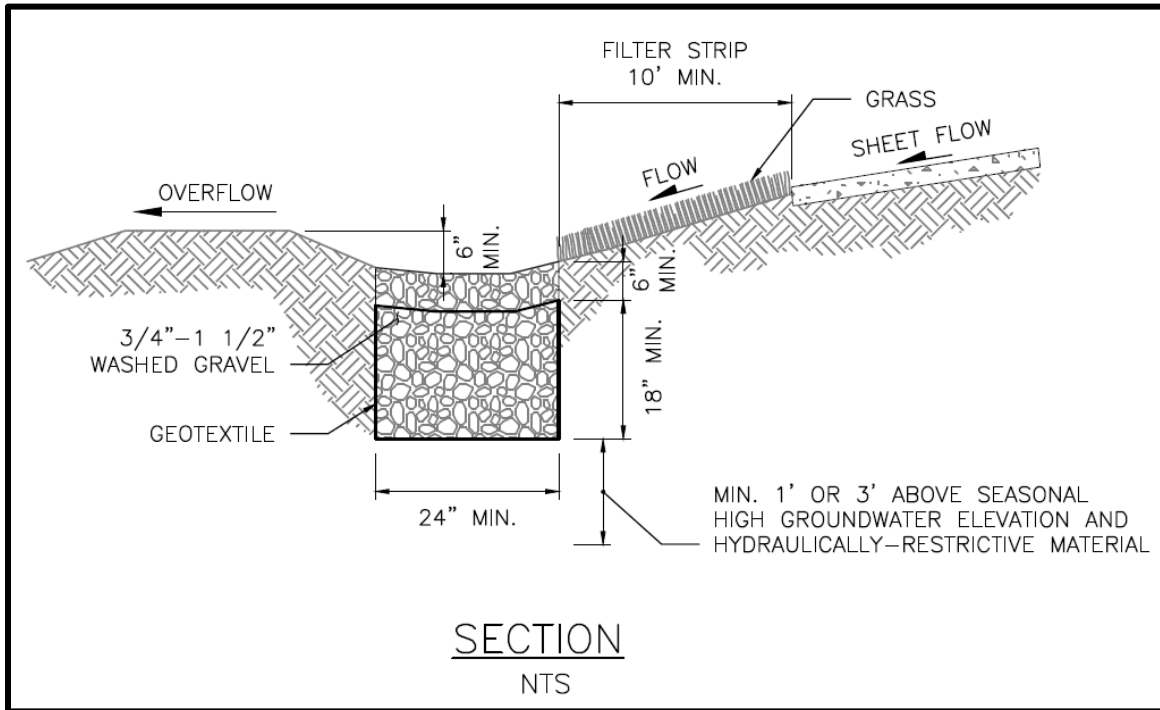

Figure 5.95-8. Typical Infiltration Trench Receiving Sheet Flow.

5.4.2.6. BMP Credits

Credit for On-site List Approach

Infiltration trenches can only be considered for compliance with the On-Site List Requirement (refer to Section 3.3.1 and Appendix C for infeasibility criteria) when the site measured infiltration rate is at least 5 inches per hour. The hard surface area managed with an infiltration trench sized according to Table 5.145-11 meets the requirement. Aggregate-filled trench shall be a minimum of 18 inches deep (as shown in Figures 5.85-7 and 5.95-8) and between 24 and 48 inches wide.

Table 5.145-11. On-site List Sizing for Infiltration Trenches.

Subgrade Soil Design Infiltration Rate	Sizing Factor for Infiltration Trench Area ^a
1 inch/hour	15%
2.5 inches/hour	10.5%
5 inches/hour	5.7%
7.5 inches/hour	4.8%
10 inches/hour	4%

Infiltration Trench Area = Contributing Hard Surface Area x Factor (%) / 100.

Hard Surface Area Managed = Trench Area ÷ Factor (%) / 100.

^a Sizing factors developed based on Ecology sizing requirements for T5.10A in Volume V# of the SWMMWW (trench length as a function of soil type). Soil types were converted to initial infiltration rates based on Ecology's Table 3.7 – Recommended Infiltration Rates based on USDA Soil Textural Classification from Ecology's 2005 SWMMWW Volume III. Design infiltration rates were calculated by applying a correction factor of 2. Trench length was converted to a sizing factor.

Sizing factors are used to calculate the infiltration trench facility area as a function of the area contributing runoff to the trench as explained below for the Pre-sized Approach. The subgrade design infiltration rate shall be rounded down to the nearest rate in the sizing table.

Pre-sized Approach for Flow Control and Water Quality Treatment

The Pre-sized Approach may be used for projects with new and replaced hard surface areas up to 10,000 square feet. Under the Pre-sized Approach (refer to *Section 4.1.2*), pre-sized infiltration trenches may be used to achieve Pre-developed Pasture, Peak Control and Water Quality Treatment Standards. Sizing factors and equations for infiltration trenches receiving runoff from a hard surface are provided in Table [5.155-12](#). Factors are organized by flow control standard, trench depth, subgrade soil design infiltration rate, and contributing area. A 1.5-foot or 3-foot aggregate storage reservoir depth may be selected. The aggregate storage reservoir is the subsurface aggregate layer below the overflow invert elevation that stores water for infiltration into the underlying subgrade soils (refer to Figures [5.85-7](#) and [5.95-8](#)). The design rate for the subgrade soils shall be rounded down to the nearest infiltration rate in the pre-sized table (i.e., 1.0, or 2.5 inch per hour).

To use these sizing factors or equations to meet flow control standards, the facility shall meet the general requirements for infiltration trenches outlined in this section, plus the following specific requirements:

- The trench area shall be sized using the applicable sizing factor or equation.
- The average aggregate storage reservoir depth across the trench shall be set at the designated height (1.5 or 3 feet). For intermediate ponding depths (between 1.5 and 3.0 feet), the sizing factor may be linearly interpolated.
- To use pre-sized infiltration trenches to meet the water quality treatment requirement or if any runoff from PGHS is directed to the trench, the underlying soil shall meet soil requirements specified in *Section 4.5.2*.
- The aggregate storage reservoir shall be composed of Mineral Aggregate Type 4 or approved equal.
- Invert of overflow shall be set at top of the storage reservoir to provide the required aggregate storage reservoir depth (e.g., pipe invert set at 1.5 or 3 feet if the bottom of the trench is flat).

Table 5.155-12. Pre-Sized Sizing Factors and Equations for Infiltration Trenches.

Trench Depth	Subgrade Soil Design Infiltration Rate	Contributing Area (sf)	Sizing Factor/Equation for Infiltration Trench Area		
			Pre-developed Pasture Standard	Peak Control Standard	Water Quality Treatment Standard ^a
1.5 feet	1.0 inch/hour	≤ 2,000	12.0%	46.4 15.7%	5.0%
		2,001 – 10,000	[0.0764 x A] +56.3		
	2.5 inch/hour	≤ 2,000	5.4%	8.3 8.1%	2.2%
		2,001 – 10,000	[0.0311 x A] +47.2		
3.0 feet	1.0 inch/hour	≤ 2,000	8.4%	44.0 10.1%	3.5%
		2,001 – 10,000	[0.0542 x A] +61.4		
	2.5 inch/hour	≤ 2,000	3.8%	6.0 5.5%	1.6%
		2,001 – 10,000	[0.0241 x A] +27.7		

A – contributing hard surface area; sf – square feet.

For Sizing Factors: Infiltration Trench Area = Contributing Hard Surface Area x Factor (%) / 100.
Hard Surface Area Managed = Trench Area ÷ Factor (%) / 100.

For Sizing Equations: Infiltration Trench Area (sf) = [Factor x A (sf)] + Integer.
Hard Surface Area Managed (sf) = [Trench Area (sf) – Integer] ÷ Factor.

^a Pre-sized Approach may be used to meet basic or enhanced water quality treatment if soil suitability criteria are met (refer to Section 4.5.2).

The infiltration trench facility area is calculated as a function of the area contributing runoff to the trench. As an example, to meet the Pre-developed Pasture Standard using a 1.5-foot-deep infiltration trench for a contributing area between 2,000 and 10,000 square feet where the design subgrade infiltration rate of 2.5 or more inches per hour, the trench area would be calculated as: 0.0311 x contributing hard surface area + 47.2. All area values shall be in square feet.

Alternatively, infiltration trench facilities can be sized using a continuous hydrologic simulation model as described in the subsequent section.

Modeling Approach for On-site Performance Standard, Flow Control, and Water Quality Treatment

When using continuous hydrologic modeling to size infiltration trenches, the assumptions listed in Table 5.165-13 shall be applied. It is recommended that infiltration trenches be modeled as a gravel-filled trench with infiltration to underlying soil and an overflow. The contributing area, trench area, and depth should be iteratively sized until the Minimum Requirements for On-site Stormwater Management and/or Flow Control, and/or Water Quality Treatment are met (refer to *Volume 1—Project Minimum Requirements*) or where it has been determined by the Director that there is no off-site point of discharge for the project, the requirements of Section 4.3.2 are met. General sizing procedures for infiltration facilities are presented in Section 4.5.1.

Table 5.165-13. Continuous Modeling Assumptions for Infiltration Trench Facilities.

Variable	Assumption
Precipitation Series	Seattle 158-year, 5-minute series
Computational Time Step	5 minutes
HSPF Parameters	LSUR, SLSUR, NSUR shall be adjusted per Appendix F
Inflows to Facility	Surface flow and interflow from total drainage area (including impervious and pervious contributing areas) routed to facility.
Precipitation and Evaporation Applied to Facility	Yes, if sited under pervious surface (e.g., lawn). If model does not apply precipitation and evaporation to facility, include the facility area as additional impervious area in the post-developed basin area that contributes runoff to the facility.
Aggregate Storage Reservoir Depth	Average depth of aggregate below overflow invert
Aggregate Storage Reservoir Porosity	Assume maximum 30% unless test showing higher porosity is provided
Subgrade Soil Design Infiltration Rate	Design infiltration rate (<i>Section 4.5.2, Appendix D</i>)
Infiltration Across Wetted Surface Area	No (bottom area only)
Outlet Structure	Overflow elevation set at average maximum subsurface ponding depth. May be modeled as weir flow over riser edge. Note that freeboard shall be sufficient to allow water surface elevation to rise above the overflow elevation to provide head for discharge.

5.4.2.7. Minimum Construction Requirements

During construction, it is critical to prevent clogging and over-compaction of the subgrade. Minimum requirements associated with infiltration trench construction include the following:

- **Aggregate Placement and Compaction** – Place the stone aggregate in lifts and compact using plate compactors. A maximum loose lift thickness of 12 inches is allowed. The compaction process aids in adhering the geotextile to the excavation sides, thereby, reducing soil piping, geotextile clogging, and settlement problems.
- **Potential Contamination** – Prevent natural or fill soils from intermixing with the aggregate. Remove all contaminated aggregate and replace with uncontaminated aggregate.
- **Overlap** – Following the stone aggregate placement, fold the geotextile over the stone aggregate to form a 12-inch minimum longitudinal overlap. When geotextile overlaps are required between rolls, overlap the upstream roll a minimum of 2 feet over the downstream roll in order to provide a shingled effect.

5.4.2.8. Operations and Maintenance Requirements

General O&M requirements for infiltration facilities apply to infiltration trenches. Infiltration trench O&M requirements are provided in *Appendix G (BMP No. 2)*.

5.4.3. Drywells

5.4.3.1. Description

Drywells are similar to infiltration trenches but are typically deeper and require less surface area. Stormwater is delivered to the drywell by pipe.

Drywells are subject to state UIC regulations. Provided that the design and O&M criteria in this section are met, only the registration requirement applies.

<u>Ecology SWMMWW Language</u>	<u>References</u>
<u>All UIC wells must be registered except: UIC wells at single-family homes (or duplexes) receiving only residential roof runoff used to collect stormwater runoff from roof surfaces on an individual home (or duplex) or for basement flooding control.</u>	<ul style="list-style-type: none"> <u>Volume I, Chapter 4, Section 1-4.3 of the SWMMWW (Ecology 2019)</u>

5.4.3.2. Performance Mechanisms

Flow control occurs through temporary storage of stormwater runoff in the spatial voids of the aggregate material, and subsequent infiltration of stormwater into the underlying soils.

5.4.3.3. Applicability

A drywell can be designed to provide on-site stormwater management and/or flow control. This BMP can be applied to meet the requirements listed below.

BMP	On-site		Flow Control			Water Quality				Conveyance
	List	Standard	Forest	Pasture	Peak	Basic	Enhanced	Oil Control	Phosphorus	
Drywell	✓ ^a	✓ ^a	✓ ^a	✓ ^a	✓ ^a					

^a Drywells are only applicable where the site measured infiltration rate is at least 5 inches per hour. PGHS or PGPS may only be directed to drywells if the soil suitability criteria for the subgrade soils is met (Section 4.5.2).

5.4.3.4. Site Considerations

Site considerations for the applicability of drywells are provided in Section 3.2 and Section 4.5. Refer to Appendix C for additional infeasibility criteria for the On-site List Approach.

5.4.3.5. Design Criteria

This section following provides a description and requirements for the components of drywells. Figure 5.105-9 shows a typical drywell system. Design criteria are provided in this section for the following elements:

- Drywell dimensions and layout
- Aggregate material

- Geotextile
- Subgrade
- Flow entrance and presettling
- Perforated pipe
- Observation port
- Overflow

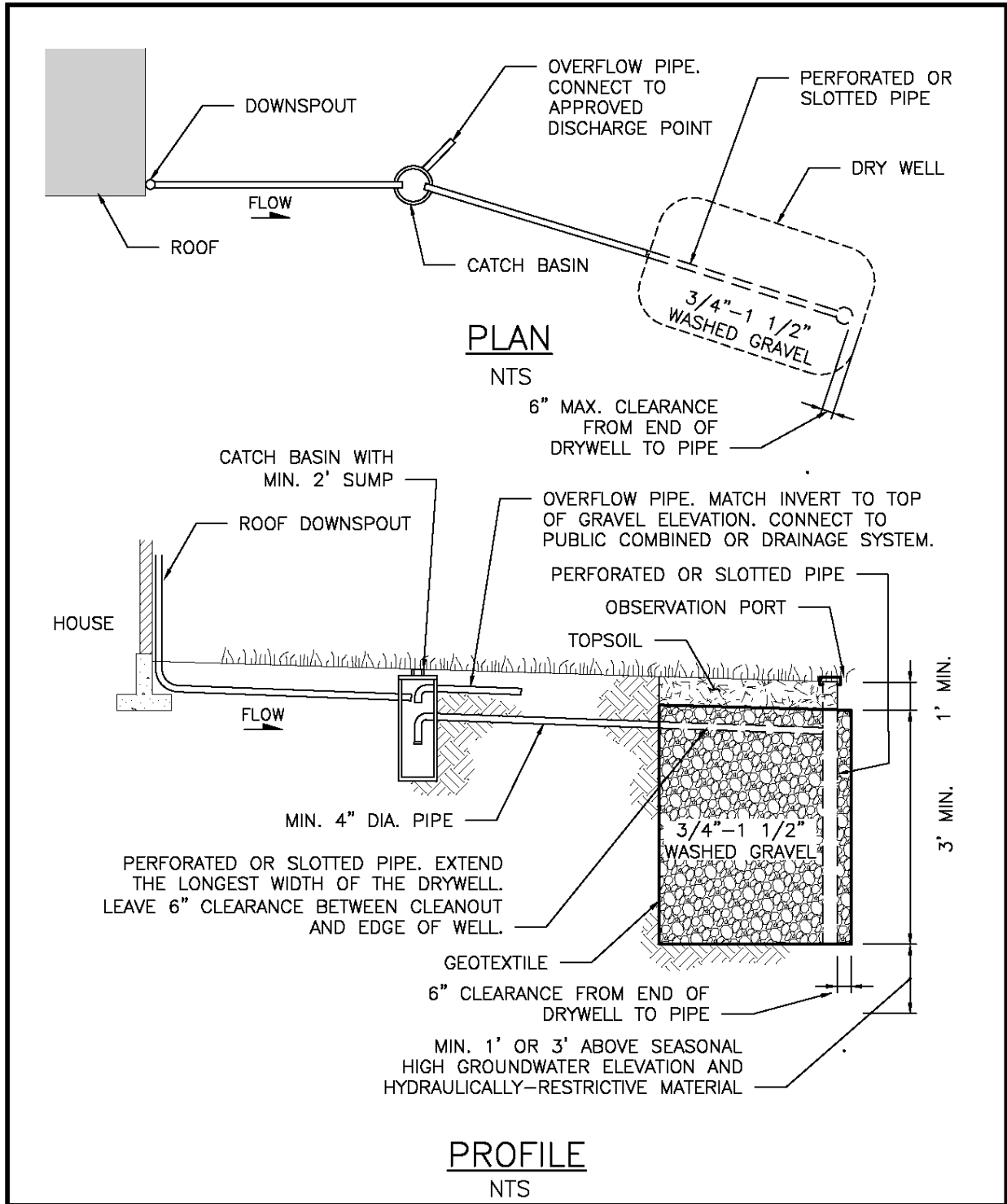

Figure 5.105-9. Typical Infiltration Drywell.

Drywell Dimensions and Layout

Minimum requirements associated with the drywell dimensions and layout include the following:

- The minimum depth of a drywell (aggregate and cover) shall be 4 feet.
- Spacing between drywells shall be a minimum of 10 feet.
- The drywell can be placed under a pervious or impervious surface cover to conserve space.

Aggregate Material

Drywells shall be filled with uniformly graded, washed gravel with a nominal size from 0.75- to 1.5-inch diameter. The minimum void volume shall be 30 percent. These requirements can be met with City of Seattle Mineral Aggregate Type 4.

Geotextile

Non-woven geotextile fabric, according to the specifications presented in *Appendix E*, shall be placed around the walls, bottom and top of the drywell aggregate. A 6-inch minimum layer of sand may be used as a filter media instead of geotextile at the bottom of the well, but geotextile is still required on the sides and top of the aggregate material.

Subgrade

The minimum measured subgrade infiltration rate for drywells is 5 inches per hour. If runoff from any PGHS is directed to the drywell, underlying soil shall meet the soil requirements outlined in *Section 4.5.2*.

During construction the subgrade soil surface can become smeared and sealed by excavation equipment. The design shall require scarification or raking of the side walls and bottom of the facility excavation to a minimum depth of 4 inches after excavation to restore infiltration rate.

Flow Entrance and Presettling

Flows shall be delivered to the drywell aggregate using a pipe with a 4-inch minimum diameter. Stormwater inflows shall be routed through a catch basin ~~or yard drain~~ with downturned elbow (trap). Presettling requirements are provided in *Section 4.4.5*.

Observation Port

Drywells that are designed to meet flow control requirements and receive runoff from contributing areas of 5,000 square feet or more shall be equipped with an observation port to measure the drawdown time following a storm and to monitor sedimentation to determine maintenance needs. Observation wells shall consist of a 4-inch minimum diameter perforated or slotted pipe that extends to the bottom of the drywell (i.e., to the subgrade) and is equipped with a secure well cap.

Overflow

Drywells shall have an overflow designed to convey any flow exceeding the capacity of the facility unless designed to fully infiltrate all flows for the full, required simulation period. Plans shall indicate surface flow paths in case of failure of the BMP (refer to Section 4.3.3). ~~per Section 4.3.4.~~ If overflow is connected to the public drainage system, a catch basin shall be installed prior to the connection to the public drainage system to prevent root intrusion into public drainage main lines.

To prevent damage to overlying pavement, drywells located beneath pavement shall be constructed with a trench pipe overflow connected to a ~~small yard drain or~~ catch basin with a grate cover. Design shall be such that, if the drywell infiltration capacity is exceeded, the trench pipe overflow would occur out of the catch basin to an approved point of discharge. The vertical elevation difference between the pavement surface and the trench pipe overflow invert shall be one foot minimum.

5.4.3.6. BMP Sizing

Sizing for On-site List Approach

Drywells can only be selected to meet the On-site List Requirement (refer to Section 3.3.1 and Appendix C for infeasibility criteria) when the site measured infiltration rate is at least 5 inches per hour. The hard surface area managed with a drywell sized according to Table 5.145.17 meets the requirement.

Table 5.145.17. On-site List Sizing for Drywells.

Aggregate Depth	Subgrade Soil Design Infiltration Rate	Sizing Factor for Facility Bottom Area ^a
		On-site List
4 feet	2.5 inch/hour	2.4%
	5 inches/hour	2.4%
	7.5 inches/hour	2.3%
	10 inches/hour	2.1%

Drywell Area (sf) = Contributing Hard Surface Area x Factor (%) / 100.

Hard Surface Area Managed = Drywell Area ÷ Factor (%) / 100.

Drywell shall be a minimum of 48 inches in diameter.

^a Sizing factors developed based on Ecology sizing requirements for T5.10A in Volume VIII of the SWMMWW (drywell aggregate volume as a function of soil type). Soil types were converted to initial infiltration rates based on Ecology's Table 3.7 – Recommended Infiltration Rates based on USDA Soil Textural Classification from Ecology's 2005 SWMMWW Volume III. Design infiltration rates were calculated by applying a correction factor of 2. Drywell volume was converted to a sizing factor.

Pre-sized Approach for Flow Control

The Pre-sized Approach may be used for projects with new and replaced hard surface areas up to 10,000 square feet. Under the Pre-sized Approach (refer to Section 4.1.2), pre-sized drywells may be used to achieve Pre-developed Pasture and Peak Control Standards. Sizing factors and equations for drywells receiving runoff from a hard surface are provided in Table 5.155.18. Factors are organized by flow control standard, drywell depth, subgrade soil design infiltration rates and contributing area. A 4-foot or 6-foot aggregate storage reservoir

depth may be selected. The aggregate storage reservoir is the subsurface aggregate layer below the overflow invert elevation that stores water for infiltration into the underlying subgrade soils. The design rate for the subgrade soils shall be rounded down to the nearest infiltration rate in the pre-sized table (i.e., 1.0 or 2.5 inch per hour).

To use these sizing factors or equations to meet flow control standards, the facility shall meet the general requirements for drywells outlined in this section plus the following specific requirements:

- The drywell area shall be sized using the applicable sizing factor or equation.
- The average aggregate storage reservoir depth in the drywell shall be set at the designated height (e.g., 4 feet). For intermediate ponding depths (between 4 and 6 feet), the sizing factor may be linearly interpolated.
- If any runoff from PGHS is directed to the drywell, the underlying soil shall meet soil requirements specified in *Section 4.5.2*.
- The aggregate storage reservoir shall be composed of Mineral Aggregate Type 4 or approved equal.
- The invert of the overflow shall be set at top of the storage reservoir to provide the required aggregate storage reservoir depth (e.g., pipe invert set at 4 feet if the bottom of the well is flat).

Table 5-155.18. Pre-Sized Sizing Factors and Equations for Drywells.

Drywell Depth	Subgrade Soil Design Infiltration Rate	Contributing Area (sf)	Sizing Factor/Equation for Drywell Area	
			Pre-developed Pasture Standard	Peak Control Standard
4.0 feet	1.0 inch/hour	≤ 2,000	7.0%	9.28.9%
		2,001 – 10,000	$[0.0463 \times A] + 49.1$	
	2.5 inch/hour	≤ 2,000	3.1%	5.14.6%
		2,001 – 10,000	$[0.0212 \times A] + 20.2$	
6.0 feet	1.0 inch/hour	≤ 2,000	4.3%	6.45.4%
		2,001 – 10,000	$[0.032 \times A] + 22.5$	
	2.5 inch/hour	≤ 2,000	2.2%	3.93.3%
		2,001 – 10,000	$[0.0172 \times A] + 10.4$	

A – contributing hard surface area; sf – square feet.

Drywell shall be a minimum of 48 inches in diameter.

For Sizing Factors: Drywell Area = Contributing Hard Surface Area x Factor (%) / 100.

Hard Surface Area Managed = Drywell Area ÷ Factor (%) / 100.

For Sizing Equations: Drywell Area (sf) = [Factor x A (sf)] + Integer.

Hard Surface Area Managed (sf) = [Drywell Area (sf) - Integer] ÷ Factor.

The drywell facility area is calculated as a function of the area contributing runoff to the drywell. As an example, to meet the Pre-developed Pasture Standard using a 6-foot-deep drywell for a contributing area less than 2,000 square feet, the well area would be equal to 4.3 percent of the contributing area when the subgrade infiltration rate is between 1.0 and 2.49 inches per hour.

Alternatively, drywell facilities can be sized using a continuous hydrologic simulation model as described in the subsequent section.

Modeling Approach for On-site Performance Standard and Flow Control

Continuous hydrologic modeling may be used to size drywells using the general infiltration BMP sizing procedures presented in *Section 4.5.1* and the procedures presented for infiltration trenches in *Section 5.4.2.6*.

5.4.3.7. *Minimum Construction Requirements*

During construction, it is critical to prevent clogging and over-compaction of the subgrade. Minimum requirements associated with drywell construction include the following:

- **Aggregate Placement and Compaction** – Place the stone aggregate in lifts and compact using plate compactors. A maximum loose lift thickness of 12 inches is allowed. The compaction process aids in adhering the geotextile to the excavation sides, thereby, reducing soil piping, geotextile clogging, and settlement problems.
- **Potential Contamination** – Prevent natural or fill soils from intermixing with the aggregate. Remove all contaminated aggregate and replace with uncontaminated aggregate.
- **Overlap** – Following the stone aggregate placement, fold the geotextile over the stone aggregate to form a 12-inch minimum longitudinal overlap. When geotextile overlaps are required between rolls, overlap the upstream roll a minimum of 2 feet over the downstream roll in order to provide a shingled effect.

5.4.3.8. *Operations and Maintenance Requirements*

General O&M requirements for infiltration facilities apply to drywells. Drywell O&M requirements are provided in *Appendix G (BMP No 2)*.

5.4.4. Infiltrating Bioretention

5.4.4.1. Description

Infiltrating bioretention facilities are shallow earthen depressions or vertical walled open-bottom boxes with a designed soil mix and plants adapted to the local climate and soil moisture conditions. Stormwater is stored as surface ponding before it filters through the underlying bioretention soil. Stormwater that exceeds the surface storage capacity overflows to an adjacent drainage system. Treated water is infiltrated into the underlying soil or, in soils with lower infiltration rates, collected by an underdrain and discharged to the drainage system. Bioretention facilities can be individual cells or multiple cells connected in series.

Two variations of infiltrating bioretention facilities are included in this section:

- **Infiltrating bioretention facility:** Bioretention facilities can have either sloped sides (e.g., an earthen depression) or vertical sides (e.g., vertical walled open-bottom box). Infiltrating bioretention cells are not lined, and may or may not have an underdrain or outlet control structure (e.g., orifice).
- **Infiltrating bioretention facility series:** Bioretention facilities with sloped or vertical sides may be connected in series, with the overflows of upstream cells directed to downstream cells to provide additional flow control and/or treatment and conveyance. Individual cells are defined as separate ponding areas delineated by distinct overflow to a downstream BMP or point of discharge.

Rain gardens are similar to infiltrating bioretention facilities, but are subject to fewer technical requirements (refer to *Section 5.4.5*). Bioretention facilities are considered non-infiltrating if they include a liner, ~~or other low-permeability barrier,~~ or impermeable barrier to [restrict or](#) prevent infiltration to the underlying soil (refer to *Section 5.8.2*).

5.4.4.2. Performance Mechanisms

Infiltrating bioretention provides flow control via detention, attenuation, and losses due to infiltration, interception, evaporation, and transpiration. Water quality treatment is accomplished through sedimentation, filtration, adsorption, uptake, or biodegradation and transformation of pollutants by soil organisms, soil media, and plants.

5.4.4.3. Applicability

Infiltrating bioretention facilities can be designed to provide on-site stormwater management, flow control and/or water quality treatment. This BMP can be applied to meet or partially meet the requirements listed below.

BMP	On-site		Flow Control			Water Quality				Conveyance
	List	Standard	Forest	Pasture	Peak	Basic	Enhanced	Oil Control	Phosphorus	
Infiltrating bioretention without underdrain	✓	✓	✓	✓	✓	✓	✓		✓ ^b	✓ ^c
Infiltrating bioretention with underdrain	✓	✓ ^a	✓ ^a	✓ ^a	✓ ^a	✓	✓		✓ ^b	✓ ^c

^a Standard may be partially or completely achieved depending upon ponding depth, degree of underdrain elevation, infiltration rate, contributing area, and use of orifice control.

^b Refer to [treatment train options for infiltration BMPs included in Section 4.4.3.2 Soil Suitability Criteria in Section 4.5.2.](#)

^c Infiltrating bioretention facilities may be connected in series, with the overflows from upstream cells directed to downstream cells to provide conveyance.

5.4.4.4. Site Considerations

Site considerations for the applicability of infiltrating bioretention are provided in *Section 3.2* and *Section 4.5*. Additional site considerations apply for nutrient-critical receiving waters:

- **Phosphorous considerations:** Infiltrating bioretention is not permitted within 1/4 mile of nutrient-critical receiving waters if the underlying soil does not meet the soil requirements outlined in *Section 4.5.2*. Bioretention with an underdrain is not permitted if the underdrained water would be routed to a nutrient-critical receiving water.
- Refer to *Appendix C* for additional infeasibility criteria for the On-site List Approach.

5.4.4.5. Design Criteria

This section provides a description, recommendations, and requirements for the components of bioretention facilities. Typical components of bioretention facilities without underdrains and configured sloped and vertical sides are shown in Figures [5.115-10](#) and [5.125-11](#), respectively. Typical components of bioretention facilities with underdrains and configured sloped and vertical sides are shown in Figures [5.135-12](#) and [5.145-13](#), respectively. Refer to *Appendix C* for additional infeasibility criteria for the On-site List Approach. [Further guidance can be found in SPU's Green Stormwater Infrastructure Manual for Capital Improvement Projects and Seattle Streets Illustrated, the Right-of-Way Improvements Manual \(refer to SDOT/SDCI Director's Rules 04-2017/31-2017\).](#)

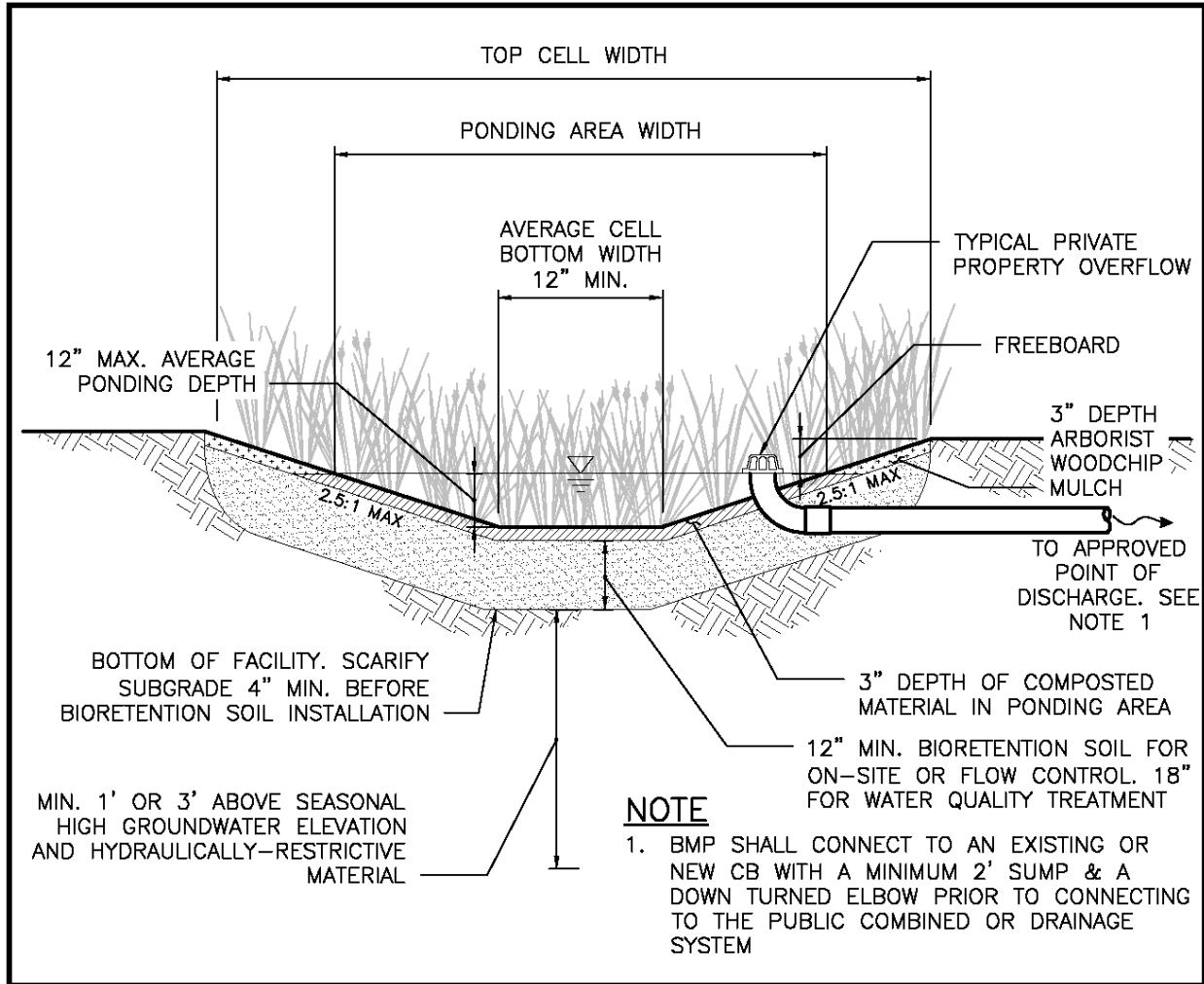

Figure 5.115-10. Infiltrating Bioretention Facility with Sloped Sides (without Underdrain).

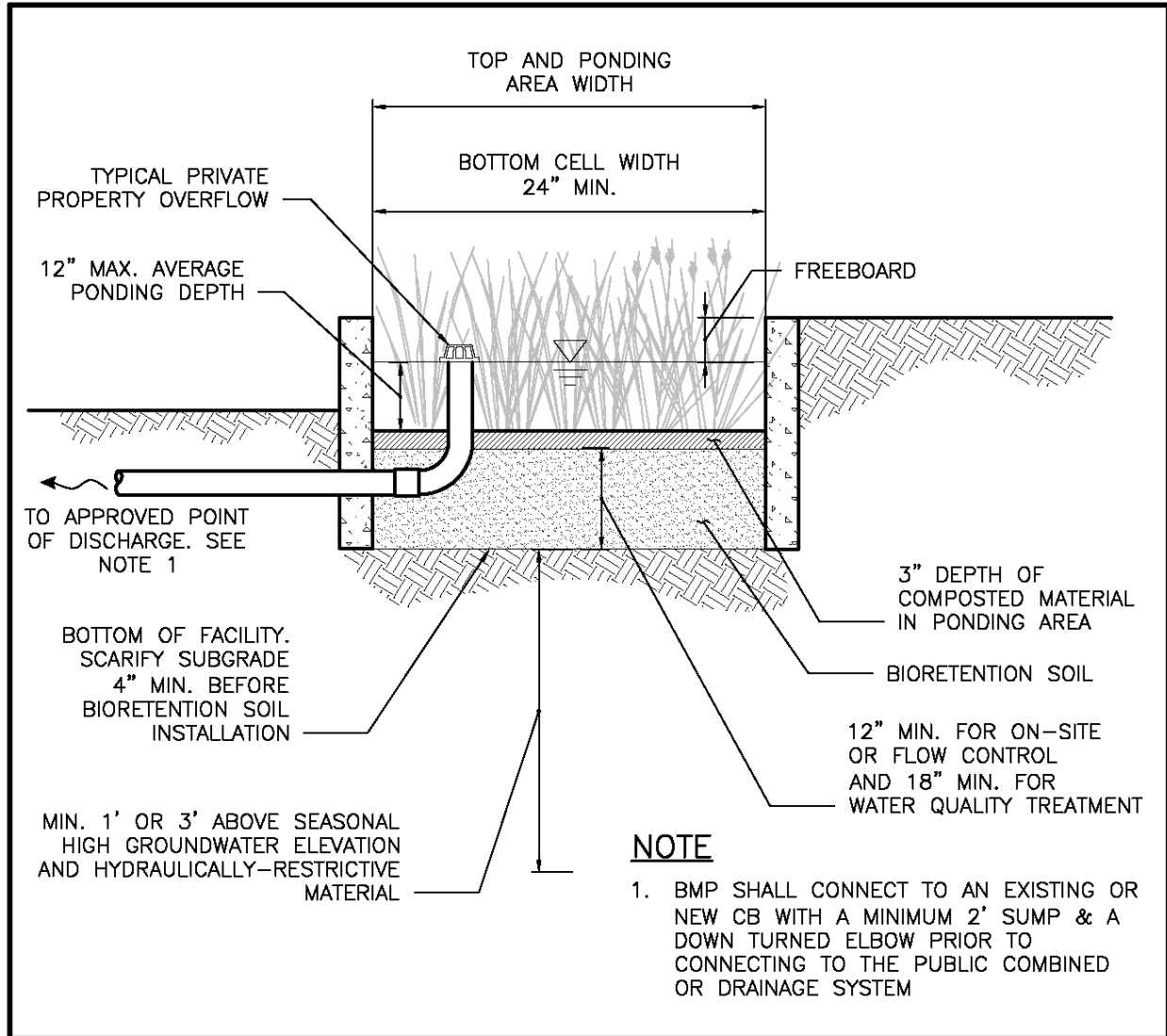

Figure 5.125-11. Infiltrating Bioretention Facility with Vertical Sides (without Underdrain).

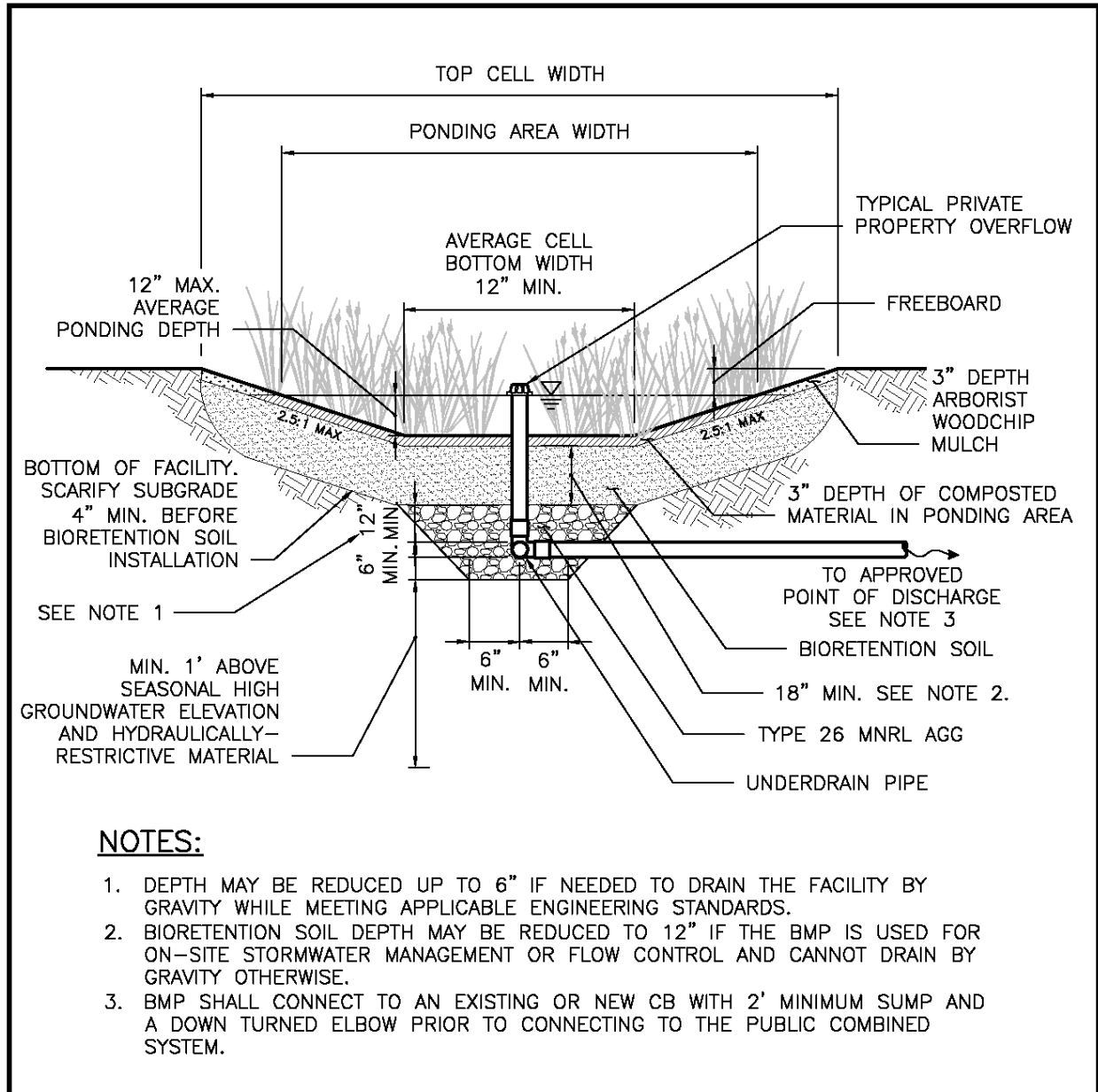

Figure 5.135-12. Infiltrating Bioretention Facility with Sloped Sides (with Underdrain).

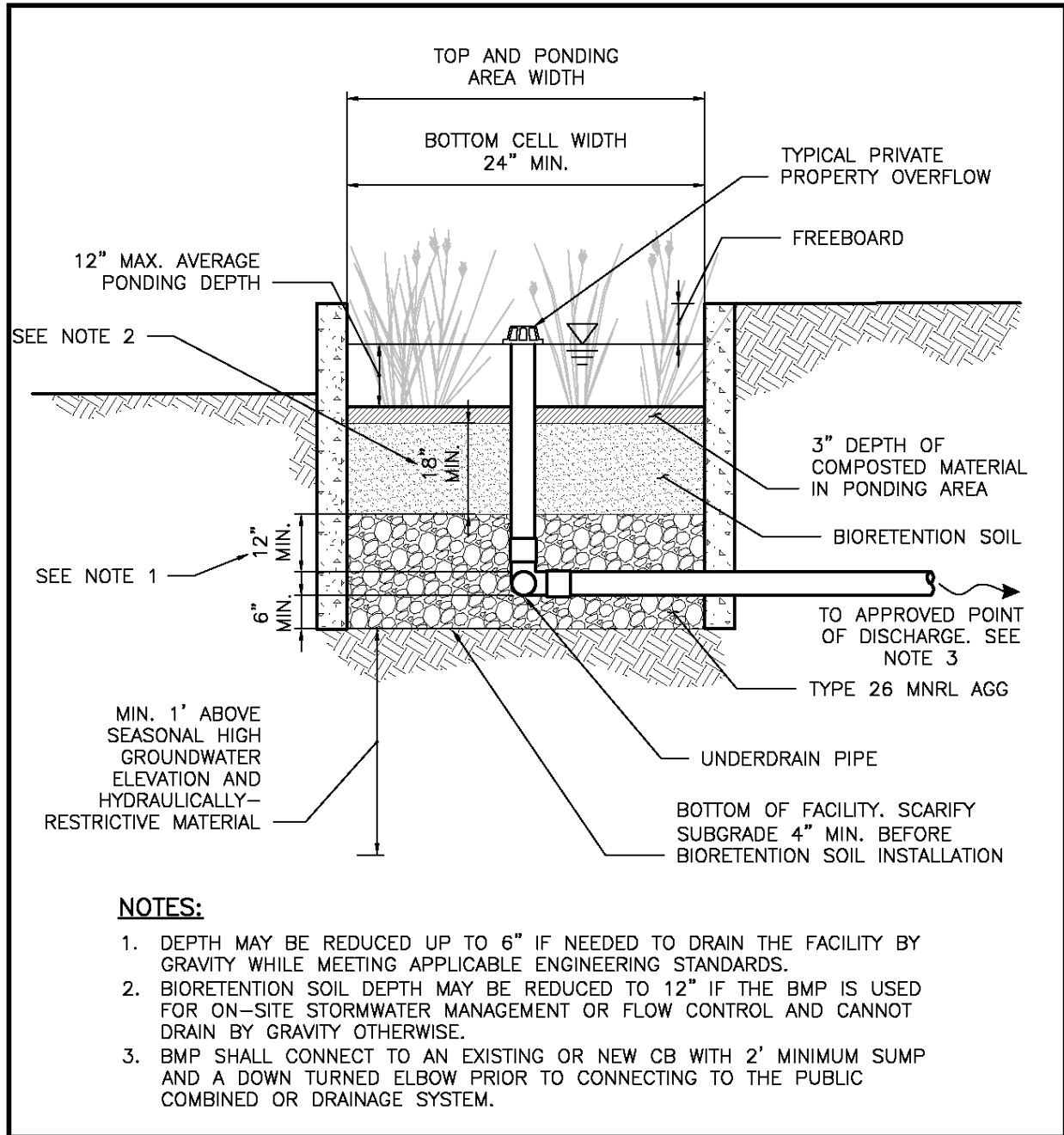

Figure 5.145-13. Infiltrating Bioretention Facility with Vertical Sides (with Underdrain).

Design criteria are provided in this section for the following elements:

- Contributing area
- Flow entrance
- Presettling
- Ponding area

- Bioretention soil
- Subgrade
- Underdrain (if required)
- Flow restrictor (optional)
- Overflow
- Liners (optional)
- Plant material
- Mulch layer

The Low Impact Development Technical Guidance Manual for Puget Sound (Puget Sound LID Manual) provides additional guidance on bioretention design.

Contributing Area

Bioretention cells are small and distributed. Unless approved by the Director, the contributing area to a bioretention facility is limited as follows:

- No single cell may receive runoff from more than 5,000 square feet of impervious area, unless as noted below for a series of bioretention cells.
- The bottom area of an individual cell shall be no larger than 800 square feet per the Ponding Area section (page 5-59). Runoff from more than 5,000 square feet of impervious area may be directed to an upstream cell in a bioretention series (interconnected series of cells). Note that in this case, the first cell or two will receive the heaviest pollutant loading and will require more maintenance than the other cells in the series.
- Contributing area to a single bioretention cell not part of a series may be greater than 5,000 square feet of impervious area only with the permission of the Director. Large contributing areas increase concerns about sediment accumulation and maintenance.

The bioretention facility should be sized for the contributing area routed to the facility. It is recommended that facilities not be oversized because the vegetation in oversized facilities may not receive sufficient stormwater runoff for irrigation, increasing maintenance. If a designer chooses to oversize the bioretention facility beyond the area required to meet the performance standard(s), the maximum allowable size (cell bottom area as a percent of the contributing area) is twice the size required to meet the Pre-developed Pasture Standard. The bottom area of the facility that is required to meet the performance standard(s) and the standard(s) being met shall be clearly noted on submitted plans and differentiated from the surrounding landscape.

Stormwater flows from other areas (beyond the area for which the facility is sized) should be bypassed around the facility in order to reduce sediment loading to the cell and the potential for bioretention soil clogging and increased maintenance needs.

For water quality treatment facilities, if bypass is not feasible, facilities shall be sized to treat runoff from the entire area draining to the facility.

It is also preferred that on-site and flow control facilities be sized for the entire area draining to the facility where feasible. Additional flows may pass through a bioretention facility sized to meet a flow control standard or on-site stormwater management requirement with the following limitations:

- The maximum area (i.e., areas beyond the area for which the facility is sized) that may pass through a bioretention facility shall not exceed twice the area for which it is sized due to sediment loading concerns;
- No flow control or on-site stormwater management credit is given for runoff from any area in excess of the area for which the facility was sized;
- If additional area is routed to a facility, it shall be clearly noted on submitted plans;
- The overflow infrastructure shall be sized for the full contributing area (refer to *Section 4.3.3*);
- ~~Projects shall still meet the flow control standards at the point of compliance; and~~
- Presettling calculations shall demonstrate that the water velocities in the vegetated areas of the facility do not exceed 2 feet per second during peak flows with 4 percent annual probability (the 25-year recurrence interval flow) (calculated through the narrowest vegetated cross section of the facility).

Flow Entrance

Flow entrances shall be sized to capture flow from the drainage area and designed to both reduce the potential for clogging at the inlet and prevent inflow from causing erosion in the facility. Four primary types of flow entrances can be used for bioretention facilities: dispersed flow (e.g., vegetated buffer strips), sheet flow, curb cuts, and concentrated flow (e.g., piped flow). Where feasible and appropriate within the site context, vegetated buffer strips are the preferred entrance type because they slow incoming flows and provide initial settling of particulates.

The minimum requirements associated with the flow entrance design include the following:

- For facilities in the right-of-way, the flow entrance elevation shall be above the overflow elevation.
- For sheet flow into a facility, a minimum 1-inch drop from the edge of a contributing hard surface to the vegetated flow entrance is required. This drop is intended to allow for less frequent maintenance by allowing some sediment/debris buildup at the edge where flow enters the facility. Refer to City of Seattle Standard Plan No. 292 and 293.
- The following requirements apply to roadway and parking lot curb cut flow entrances:
 - The curb cut width shall be sized based on the drainage area, longitudinal slope along the curb, and the cross slope at the inlet.
 - The minimum curb cut width shall be 8 inches for non-right-of-way applications (e.g., parking lots) and 10 inches in the right-of-way (refer to the City of Seattle Plan Nos. 295a, 295b, 295c, and 295d~~296, 297, and 298~~).
 - The curb cut shall have either a minimum of 8 percent slope from the outer curb face extending to a minimum of 12 inches beyond the back of curb, or provide a

minimum of a 2-inch vertical drop from the back of curb to the vegetated surface of the facility.

- If concentrated flows are entering the facility (e.g., pipe or curb cut), flow energy dissipation (e.g., rock/cobble pad or flow dispersion weir) shall be incorporated to reduce the potential for erosion at the inlet.

Presettling

Presettling to capture debris and sediment load from contributing drainage areas is required at the flow entrance for some bioretention facilities. By having a designated presettling zone, maintenance can be targeted in this area to remove sediment build-up.

The minimum requirements associated with the presettling design include the following:

- The minimum presettling requirements for bioretention facilities sited in the public right-of-way collecting runoff from pollution generating impervious surfaces are provided in Table 5-165.19.
- The minimum presettling requirements for bioretention facilities sited in all other settings are provided in the Table 5-175.20.
- If the cell will receive flows from impervious areas beyond the area for which the facility is sized, the presettling measures shall be designed for the entire area draining to the facility.

The area designated as the presettling zone shall not be included in the bottom area required to meet on-site stormwater management, flow control and/or water quality treatment. However, the presettling zone shall be included in the total landscaped facility top area for evaluation against the 500 square foot threshold for right-of-way project infeasibility (Appendix C). [An example bioretention presettling zone is provided in City of Seattle Standard Plan No. 299.](#)

Table 5-165.19. Presettling Requirements for Bioretention Facilities in Roadway Projects.

Longitudinal Length of Street (L) or Impervious Area ^a (A) Contributing Runoff to a Single Flow Entrance	Presettling Requirements
Residential Streets	
$L \leq 360$ linear feet of gutter OR $A \leq 6,700$ square feet of ROW impervious area AND Pollution Generating Impervious Surface $< 5,000$ square feet	No presettling is required.
$360 < L \leq 660$ linear feet of gutter OR $6,700 < A \leq 12,300$ square feet of ROW impervious area OR Pollution Generating Impervious Surface $\geq 5,000$ square feet	At a minimum, the bottom of the first 2 feet in length (for a total area of 2.5 square feet) of the upstream bioretention cell (at the flow entrance) shall be designated the presettling zone. This bottom area shall be constructed of a roughened concrete pad surrounded by cobbles per City of Seattle Standard Plan No. 299290 .

Table 5.165.19 (continued). Presettling Requirements for Bioretention Facilities in Roadway Projects.

Longitudinal Length of Street (L) or Impervious Area ^a (A) Contributing Runoff to a Single Flow Entrance	Presettling Requirements
Residential Streets (continued)	
L > 660 linear feet of gutter OR A > 12,300 square feet of ROW impervious area	Presettling requirements are project specific, to be determined by designer and approved by the Director.
Arterial Streets	
L ≤ 360 linear feet of gutter OR A ≤ 9,000 square feet of ROW impervious area	At a minimum, the bottom of the first 2 feet in length (for a total area of 2.5 square feet) of the upstream bioretention cell (at the flow entrance) shall be designated the presettling zone. This bottom area shall be constructed of a roughened concrete pad surrounded by cobbles per City of Seattle Standard Plan No. 299290 .
360 < L ≤ 660 linear feet of gutter OR 9000 < A ≤ 16,500 square feet of ROW impervious area	The full length of the first cell (in a series), which should have a bottom length of 8–10 feet designated as the presettling zone. At a minimum, the bottom of the first 2 feet in length (for a total area of 5 square feet) of this presettling zone shall have a roughened concrete pad. This initial bottom area should be followed by a porous weir that allows water to be temporarily detained and slowed down, such as a row of boulders set low (a few inches above the bottom of bioretention cell).
L > 600 linear feet of gutter OR A > 16,500 square feet of ROW impervious area	Presettling requirements are project specific, to be determined by designer and approved by the Director.

^a All ROW impervious area contributing runoff to the facility shall be included (e.g., roadway, sidewalk, driveways). Runoff from ROW pervious surfaces need not be included. Runoff from adjacent non-ROW impervious areas can be considered incidental and need not be included unless assessment of the site determines that the adjacent area that contributes runoff is greater than 10% of the total ROW impervious area.

Table 5.175.20. Presettling Requirements for Bioretention Facilities in Non-roadway Projects.

Impervious Area (square feet) Contributing Runoff to a Single Flow Entrance	Presettling Requirements
< 5,000	No presettling is required. Designer to determine if site specific presettling is needed based on upstream area conditions.
≥ 5,000 and < 10,000	The bottom of the first 2 to 3 feet of the upstream bioretention cell (at the flow entrance) shall be designated the presettling zone. This bottom area of the cell shall be constructed of cobbles, concrete open celled paving grids, plastic lattices filled with gravel or groundcover vegetation, a roughened concrete pad, or similar material for collection of sediment for maintenance. Alternatively, a catch basin (such as City of Seattle Standard Plan No. 240 or 241) with a minimum 2-foot sump may be used as the presettling zone. Where the pipe (from the catch basin) daylight into the bioretention cell, provide energy dissipation within the cell.

Table 5.175.20 (continued). Presettling Requirements for Bioretention Facilities in Non-roadway Projects.

Impervious Area (square feet) Contributing Runoff to a Single Flow Entrance	Presettling Requirements
≥ 10,000	Presettling requirements are project specific, to be determined by designer and approved by the Director.

Ponding Area

The ponding area provides surface storage for storm flows and the first stages of pollutant treatment within the bioretention facility. The minimum requirements for ponding area design for facilities with both side slopes and vertical sides include:

- The bottom area of an individual cell shall be no larger than 800 square feet (limitation is to ensure that bioretention facilities are small-scale and distributed). [The bottom of an individual cell may be larger than 800 square feet if the facility serves a regional area and with the permission of the Director.](#)
- The bottom area of an individual cell shall be no less than 4 square feet.
- The average ponding depth shall be no less than 2 inches.
- The ponding depth shall be no more than 12 inches. In right-of-way areas with high pedestrian traffic, the ponding depth may be restricted to 6 inches or less.
- The surface pool drawdown time shall be a maximum of 24 hours (drain time is calculated as the maximum ponding depth divided by the subgrade soil design infiltration rate). Note that facilities sized using the On-site List and Pre-sized Approach meet this requirement.
- The bottom slope shall be no more than 3 percent.

Additional minimum requirements for ponding area design specific to bioretention facilities with side slopes include the following:

- The maximum planted side slope is 2.5H:1V. In the ROW, if the facility is on a curbless street and less than 50 feet of an intersection, the maximum planted side slope is 3H:1V. If total facility depth exceeds 3 feet, the maximum planted side slope is 3H:1V. If steeper sides are necessary, rockery, concrete walls, or steeper soil wraps may be used.
- If berming is used to achieve the minimum top facility elevation needed to meet ponding depth and freeboard needs, maximum berm slope is 2.5H:1V, and minimum berm top width is 6 inches. Soil used for berming where the permanent restoration is landscape shall meet the bioretention soil specification and be compacted to a minimum of 90 percent dry density.
- For trees planted within or alongside slopes of the bioretention cell, the maximum side slope around the tree is 1H:1V.
- The average bottom width for the facility shall be no less than ~~18~~[12](#) inches.

Additional minimum requirements for ponding area design specific to bioretention facilities with vertical sides include the following:

- The facility width (planted area between walls) shall be no less than 2 feet. For plant health, the recommended minimum facility width is 4 feet.

To address traffic and pedestrian safety concerns, [refer to City of Seattle Standard Plan No. 292 and 293 for bioretention facilities in the right-of-way.](#) †The following additional minimum requirements [also](#) apply to bioretention facilities in the right-of-way:

- ~~The following minimum setbacks shall be provided for facilities with sloped sides:~~
 - ~~2 feet minimum from face of curb to top of slope on non-principal arterial streets~~
 - ~~4 feet minimum from face of curb to top of slope for principal arterial street~~
 - ~~1 foot minimum from edge of sidewalk to top of slope~~
- A minimum of one access path across planting strip shall be provided between the street and public sidewalk for each parcel. Access paths shall be a minimum of 5 feet wide. It is preferred that the access path is within 15 feet of the structure access point (such as path to doorway or stairs).
- Bioretention cells shall not impact driveway/alley access. A 2-foot minimum setback shall be provided from the pavement edge of the driveway curb cut wing to the top (top of slope) of bioretention cell.
- A two-foot minimum setback shall be provided from the edge of paving for the public sidewalk/curb ramp at the intersection to the top of slope of the bioretention cell. Curb ramp improvements are required whenever the construction of bioretention cells and associated street improvements remove pavement within the crosswalk area of the street or sidewalk, impact curbs, sidewalks, curb ramps, curb returns or landings within the intersection area, or affect access to or use of a public facility.

Bioretention Soil

The minimum requirements associated with bioretention soil design include:

- The bioretention soil shall meet City of Seattle Standard Specification 7-21. Soil shall be a well-blended mixture of 2 parts fine compost (approximately 35 to 40 percent) by volume and 3 parts mineral aggregate (approximately 60 to 65 percent) by volume. The mixture shall be well blended to produce a homogeneous mix, and have an organic matter content of 4 to 8 percent determined using the Loss on Ignition Method. Materials shall meet the criteria provided below.
- Fine compost for bioretention soil shall meet the criteria below:
 - Gradation. Fine compost shall meet the following size gradations by dry weight when tested in accordance with the U.S. Composting Council *Testing Methods for the Examination of Compost and Composting (TMECC) Test Method 02.02-B, Sample Sieving for Aggregate Size Classification*:

Sieve Size	Percent Passing	
	Minimum	Maximum
2"	100%	
1"	99%	100%
5/8"	90%	100%
1/4"	75%	100%

- pH. The pH shall be between 6.0 and 8.5 when tested in accordance with TMECC 04.11-A; “1:5 Slurry pH.”
- Physical Contaminants. Manufactured inert material (concrete, ceramics, metal, etc.) shall be less than 1.0 percent by weight as determined by TMECC 03.08-A “percent dry weight basis.” Film plastics shall be 0.1 percent or less, by dry weight.
- Organic Content. Minimum organic matter content shall be 40 percent by dry weight basis as determined by TMECC 05.07-A; Loss-On-Ignition Organic Matter Method.
- Salinity. Soluble salt contents shall be less than 5.0 mmhos/cm tested in accordance with TMECC 04.10-A; “1:5 Slurry Method, Mass Basis.”
- Maturity. Maturity shall be greater than 80 percent in accordance with TMECC 05.05-A; “Germination and Vigor.” The Engineer may also evaluate compost for maturity using the Solvita Compost Maturity Test at time of delivery. Fine Compost shall score a number 6 or above on the Solvita Compost Maturity Test. Coarse Compost shall score a 5 or above on the Solvita Compost Maturity Test.
- Stability. Stability shall be 7 or below in accordance with TMECC 05.08-B; “Carbon Dioxide Evolution Rate.”
- Feedstocks. The compost product shall contain a minimum of 65 percent by volume from recycled plant waste as defined in WAC 173-350-100 as “yard waste,” “crop residues,” and “bulking agents.” A maximum of 35 percent by volume of “post-consumer food waste” as defined in WAC 173-350-100 may be substituted for recycled plant waste. A minimum of 10 percent food waste in compost is required. The Engineer may approve compost products containing up to 35 percent biosolids or manure feedstocks for specific projects or soil blends, but these feedstocks are not allowed unless specified, and not allowed in compost used for bioretention soils.
- C:N. Fine compost shall have a carbon to nitrogen ratio of less than 25:1 as determined using TMECC 04.01 “Total Carbon” and TMECC 04.02D “Total Kjeldhal Nitrogen.” The Engineer may specify a C:N ratio up to 35:1 for projects where the plants selected are entirely Puget Sound native species. Compost may be mixed with fir or hemlock bark meeting requirements of [City of Seattle Standard Specification](#) 9-14.4(3) to raise the C:N ratio above 25:1. Coarse compost shall have a carbon to nitrogen ratio between 20:1 and 45:1.
- Mineral aggregate for bioretention soil shall be analyzed by an accredited lab using the sieve sizes noted below, and shall meet the following gradation:

Sieve Size	Percent Passing
3/8" Square	100
U.S. No. 4	60 – 100
U.S. No. 10	40 – 100
U.S. No. 40	15 – 50
U.S. No. 200	2 – 5

- [For facilities without underdrains, bioretention soil depth where no underdrain is used shall be a minimum 18 inches for water quality treatment and 12 inches for on-site stormwater management and flow control.](#)

- ~~Bioretention soil depth where an underdrain is used shall be a minimum 18 inches depth but may be reduced to a depth of 12 inches if it is needed to drain by gravity and the facility is used to meet on-site stormwater management or flow control, and flow control requirements, and 18 inches to meet water quality treatment requirements.~~
- ~~For facilities with underdrains, the bioretention soil shall have a minimum depth of 18 inches.~~

~~Filter fabrics/geotextile are not required because the gradation between the bioretention soil and the subgrade soil is typically not large enough to result in significant migration of fines from the subgrade into the bioretention soil. Additionally, filter fabrics may clog with downward migration of fines from the bioretention soil material. Therefore, f~~Filter fabrics/geotextile shall not be used between the bioretention soil layer and the underlying subgrade. Exceptions may be allowed when specified by a licensed professional as defined in *Appendix D, Section D-1* and documented in the geotechnical design recommendations.

Subgrade

The minimum measured subgrade infiltration rate for infiltrating bioretention facilities without underdrains is 0.6 inch per hour. For infiltrating bioretention facilities with underdrains, the minimum measured subgrade infiltration rate is 0.3 inch per hour where used to meet the On-site List Approach (there is no minimum rate where used to meet other standards).

During construction the subgrade soil surface can become smeared and sealed by excavation equipment. The design shall require scarification or raking of the side walls and bottom of the facility excavation to a minimum depth of 4 inches after excavation to restore infiltration rate.

Underdrain (If Required)

Underdrain systems (refer to Figures ~~5.135-12~~ and ~~5.145-13~~) ~~must~~ shall be installed if the subgrade soils have a measured infiltration rate of less than 0.6 inch per hour. Designs utilizing underdrains provide less infiltration and flow control benefits. To improve performance, the underdrain may be further elevated (beyond the 6 inches shown in Figures ~~5.135-12~~ and ~~5.145-13~~); the subsurface gravel reservoir under the pipe may be widened to extend across the entire facility bottom; and/or a flow restrictor may be used.

The underdrain pipe diameter will depend on hydraulic capacity required. The underdrain can be connected to a downstream BMP, such as another bioretention cell as part of a connected system, or to an approved point of discharge.

The minimum requirements associated with the underdrain design include:

- Slotted pipe per City of Seattle Standard Plan No. 291.
- Underdrain pipe shall have a minimum diameter of 6 inches in the ROW and 4 inches outside of the ROW.
- Underdrain pipe slope shall be no less than 0.5 percent.

- Pipe shall be placed in filter material and have a minimum cover depth of 12 inches and bedding depth of 6 inches. Refer to Figures [5.135-12](#) and [5.145-13](#) for required pipe bedding dimensions. Cover depth may be reduced up to 6 inches in order to discharge stormwater from the facility under gravity flow conditions while meeting the applicable engineering standards, ~~if approved by the Director~~.
- Filter material shall meet the specifications of City of Seattle Mineral Aggregate Type 26 (gravel backfill for drains, City of Seattle Standard Specifications).
- Underdrains shall be equipped with cleanouts and observation port as follows:
 - For right-of-way projects, underdrains shall have a cleanout per City of Seattle Standard Plans at the upstream end and a combined cleanout and observation ports per City of Seattle Standard Plan No. 281 a minimum of every 100 feet along the pipe. ~~Cleanouts and observation ports shall have locking cast iron caps. A cleanout at the upstream is not required for short runs if the exceptions defined in Section 7 of SPU CAM 1180 are met. No cleanouts are required within a run from underdrain maintenance hole to underdrain maintenance hole except at bends.~~
 - For non-right-of-way projects, underdrains shall have a cleanout at the upstream end ([Figure 5.15](#)) and a combined cleanout and observation ports ([City of Seattle Standard Plan No. 281](#)) a minimum of every 100 feet along the pipe. Cleanouts and observation ports shall be non-perforated pipe (sized to match underdrain diameter) and shall meet the requirements in the Side Sewer Directors' Rule.
- When bioretention facilities with underdrains are used to meet the Minimum Requirements for Flow Control (SMC 22.805.080) or the Minimum Requirements for Treatment (SMC 22.805.090) and drain to a retention or detention facility, the subsurface gravel reservoir beneath the underdrain pipe shall be widened to extend across the entire facility bottom.

Flow Restrictor (Optional)

A flow restrictor assembly may be installed at the outlet of an underdrain system to further detain outflow. When used, the orifice diameter shall be sized to achieve the desired performance goal. The minimum requirements associated with the flow restrictor design include:

- An inspection chamber (catch basin or maintenance hole with clearances per City of Seattle Standard Plan No. 270 and 272A) shall be installed at the flow control assembly to allow for access and maintenance.
- A minimum orifice diameter of 0.25 inch. Note that an orifice diameter smaller than 0.5 inch is allowed for this subsurface application because the bioretention soil serves as a filter, making clogging of the orifice less likely.

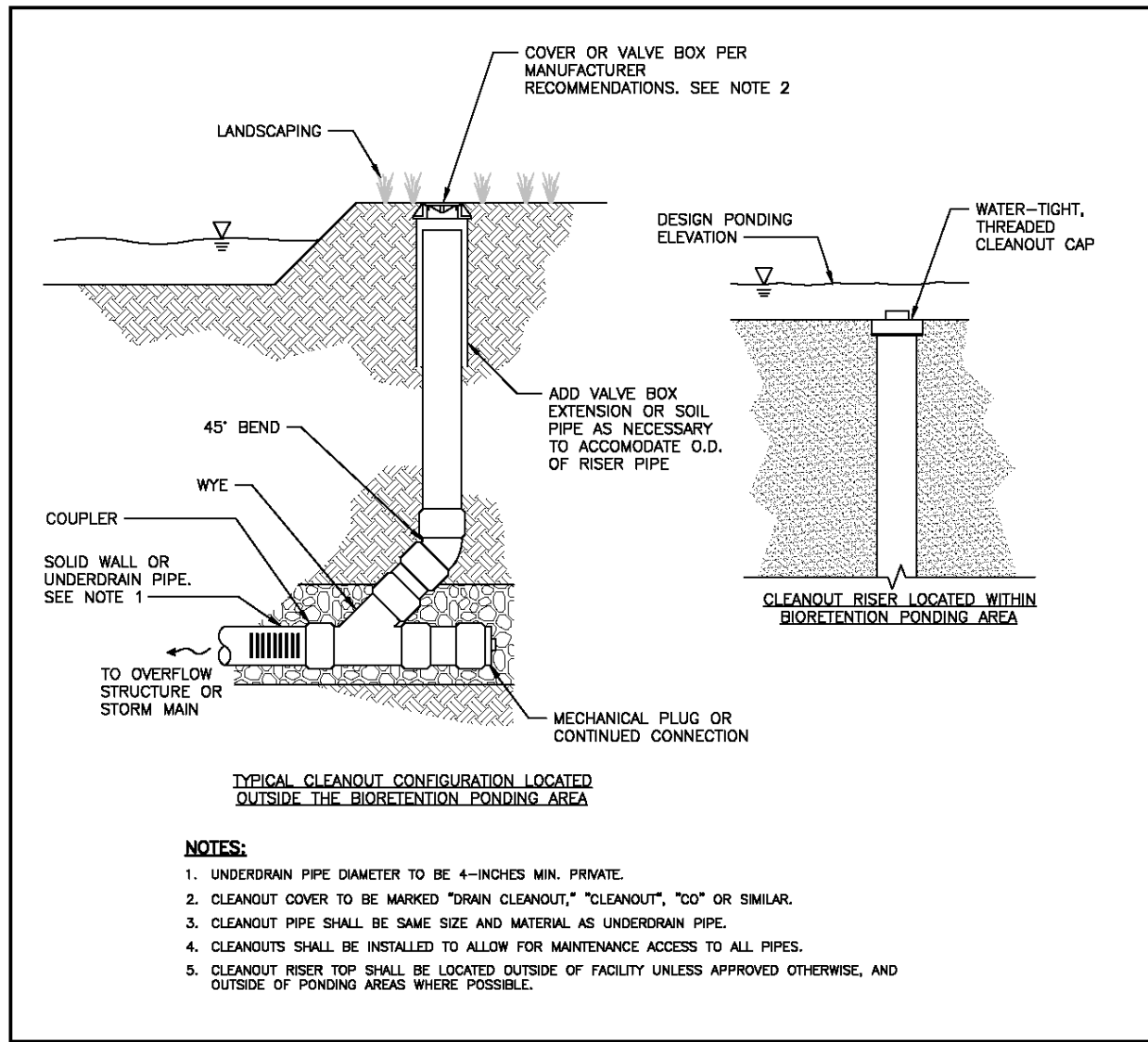

[Figure 5.15. Stormwater Facility Cleanout for Facility Outside of the Right-of-Way.](#)

Overflow

A bioretention facility overflow controls overtopping with a pipe, an earthen channel, a weir, or a curb cut installed at the designed maximum ponding elevation and is connected to a downstream BMP or an approved point of discharge.

The minimum requirements associated with the overflow design include the following:

- Overflows shall convey any flow exceeding the capacity of the facility [unless designed to fully infiltrate all flows for the full, required simulation period. Plans shall indicate surface flow paths in case of failure of the BMP \(refer to Section 4.3.3\).](#) [per Section 4.3.4.](#)
- Freeboard shall be provided to ensure that any overtopping of the facility is safely conveyed to an approved point of discharge without flooding adjacent properties or

sidewalks. The minimum freeboard measured from the invert of the overflow point (e.g., standpipe, earthen channel, curb cut) or 25-year recurrence interval water surface elevation (as specified below) to the lowest overtopping elevation of the facility is:

- 2 inches measured from the invert of the overflow point for contributing drainage areas less than 3,000 square feet
 - 4 inches measured from the invert of the overflow point for contributing drainage areas from 3,000 square feet to 5,000 square feet
 - 6 inches measured from the invert of the overflow point for contributing drainage areas from greater than 5,000 square feet to 10,000 square feet
 - 6 inches of measured from the 25-year recurrence interval water surface elevation (demonstrated with hydrologic modeling) for contributing drainage areas greater than 10,000 square feet
 - With a curb and gutter, freeboard may be reduced if the project can demonstrate that any overtopping of the facility for larger events (greater than the 25-year recurrence interval) would be consistent with *Section 4.3.3*.
- The drain pipe, if used, shall have a minimum diameter of 4 inches.
 - If the cell will receive flows from impervious areas beyond the area for which the facility is sized, the overflow conveyance infrastructure and freeboard requires engineering design to safely convey runoff from the entire area draining to the facility.

Liners (Optional)

Infiltrating bioretention facilities infiltrate stormwater into the underlying soil. However, adjacent roads, foundations, slopes, utilities, or other infrastructure may require that certain infiltration pathways are restricted to prevent excessive hydrologic loading. Two types of hydraulic restricting layers can be incorporated into bioretention facility designs:

- Clay (bentonite) liners as low permeability liners
- Geomembrane liners which completely block flow

[Refer to Appendix E, Section E-7 for more information about liners.](#)

For infiltrating bioretention facilities, the hydraulic restriction layer [shall be limited to only the extent necessary to protect adjacent area as described above](#) and shall not be used across the entire facility bottom (refer to *Section 5.8.2, Non-infiltrating Bioretention Facilities*).

The horizontal footprint of the hydraulic restriction layer ~~must~~[shall](#) be excluded from the infiltration area (bottom area and/or side slopes) represented for hydrologic modeling.

Plants

In general, the predominant plantings used in bioretention facilities are species adapted to stresses associated with wet and dry conditions. Soil moisture conditions will vary within the facility from saturated (bottom of cell) to relatively dry (rim of cell). Accordingly, wetland plants may be planted in the lower areas and drought-tolerant species planted on the

perimeter of the facility or on mounded areas. Trees selected from the bioretention plant list (*Appendix E*) are allowed and encouraged as part of bioretention.

The minimum requirements associated with the vegetation design include the following:

- The design plans shall specify that vegetation coverage of plants will achieve 90 percent coverage within 2 years. For this purpose, cover is defined as canopy cover and should be measured when deciduous plants are in bloom.
- For facilities receiving runoff from 5,000 square feet or more hard surface, plant spacing and plant size shall be designed by a licensed landscape architect to achieve specified coverage.
- The plants shall be sited according to sun, soil, wind, and moisture requirements. ([refer to Appendix E, Section E-9](#)).
- [If a bioretention facility will be located in a full shade area \(i.e., receiving less than 3 hours of direct sunlight per day\), then a licensed landscape architect shall provide input on the plant selection and layout. If a licensed landscape architect determines that plants will not survive in the fully shaded location, 3 inches of clean, washed drainage gravel backfill for drains \(Type 26\) or mulch may be used as a top dressing in lieu of plants.](#)
- At a minimum, provisions shall be made for supplemental irrigation/watering during the first two growing seasons following installation and in subsequent periods of drought.
- Plants for bioretention facilities sited in the right-of-way shall be selected from the bioretention plant list in *Appendix E, Section E-9*.

Refer to the Puget Sound LID Manual for guidance on plant selection and recommendations for increasing survival rates. Recommended planting lists can be found in the Puget Sound LID Manual, [Seattle Streets Illustrated](#), the Right-of-Way Improvements Manual ([refer to SDOT/SDCI Director's Rules 04-2017/31-2017](#)), and the Seattle Green Factor plant list (refer to SDCI Director's Rule 10-2011).

Mulch Layer

Properly selected organic mulch material reduces weed establishment, regulates soil temperatures and moisture, and adds organic matter to the soil. Compost and arborist wood chip mulch are required for different applications within the bioretention cell. Compost mulch is an excellent slow-release source of plant nutrients and does not float, but compost does not suppress weed growth as well as bulkier, higher carbon mulches like arborist wood chips. Arborist wood chips are superior to bark mulch in promoting plant growth, feeding beneficial soil organisms, reducing plant water stress, and maintaining surface soil porosity.

The minimum requirements associated with organic mulch include:

- [Organic mulch in the bottom of the cell and up to the ponding elevation shall consist of coarse or medium compost \(per City of Seattle Standard Specification 9-14.4\(8\) ~~bb~~\). Medium compost shall meet the requirements for fine compost provided in the Bioretention Soil Section and the following gradation by dry weight:](#)

<u>Sieve Size</u>	<u>Percent Passing</u>	
	<u>Minimum</u>	<u>Maximum</u>
<u>1"</u>	<u>100%</u>	<u>100%</u>
<u>5/8"</u>	<u>85%</u>	<u>100%</u>
<u>1/4"</u>	<u>70%</u>	<u>85%</u>

Coarse compost shall meet the requirements for fine compost provided in the *Bioretention Soil Section* and the following gradation by dry weight:

Sieve Size	Percent Passing	
	Minimum	Maximum
3"	100%	
1"	90%	100%
3/4"	70%	100%
1/4"	40%	6%

- Organic mulch on cell slopes above the ponding elevation and the around the rim area shall consist of arborist wood chip mulch (per City of Seattle Standard Specification 9-14.4(4)). Arborist wood chip mulch shall meet the criteria below:
 - Arborist wood chip mulch shall be coarse ground wood chips (approximately 0.5 inch to 6 inches along the longest dimension) derived from the mechanical grinding or shredding of the aboveground portions of trees. It may contain wood, wood fiber, bark, branches, and leaves; but may not contain visible amounts of soil. It shall be free of weeds and weed seeds including but not limited to plants on the King County Noxious Weed list available at: www.kingcounty.gov/weeds, and shall be free of invasive plant portions capable of resprouting, including but not limited to horsetail, ivy, clematis, knotweed, etc. It may not contain more than 0.5 percent by weight of manufactured inert material (plastic, concrete, ceramics, metal, etc.).
 - Arborist wood chip mulch, when tested, shall meet the following loose volume gradation:

Sieve Size	Percent Passing	
	Minimum	Maximum
2"	95%	100%
1"	70%	100%
5/8"	0%	50%
1/4"	0%	40%

No particles may be longer than 8 inches.

- Depth shall be A minimum of 2 inches and a maximum of 3 inches for both types of organic mulch

In bioretention areas outside of roadway right-of-way, or where higher flow velocities are anticipated, an aggregate mulch may be used. Where higher flow velocities are anticipated, the use of mineral aggregate is to dissipate flow energy and protect underlying bioretention soil. Aggregate mulch varies in size and type, but 1- to 1.5-inch gravel (rounded) decorative rock is typical. The aggregate mulch shall be washed rock (free of fines) and the area covered

with aggregate mulch shall not exceed one-fourth of the facility bottom area. [Aggregate mulch shall be free-draining and applied in a manner to maintain the permeability of the bioretention. Therefore, areas where it is applied shall not be considered hard surface.](#)

As an alternative to mulch, a dense groundcover may be used. Mulch is required in conjunction with the groundcover until groundcover is established.

5.4.4.6. BMP Sizing

Sizing for On-site List Approach

Infiltrating bioretention may be selected to meet the On-site List Requirement (refer to *Section 3.3.1* and *Appendix C* for infeasibility criteria). To meet the requirement, bioretention ~~must~~ shall be sized according to the sizing factors provided in Table [5-185.21](#). Sizing factors for facilities without underdrains are based on achieving a minimum wetted surface area of 5 percent of the contributing area or meeting the On-site Performance Standard for a pre-developed condition of forest on till (whichever is greater). Sizing factors for facilities with underdrains are increased by 11 percent (i.e., multiplied by a factor of 1.11) to account for reduced performance (due to the presence of an underdrain).

Factors are organized by cell ponding depth, cell side slope, and subgrade design infiltration rate. To select the appropriate sizing factor:

- The subgrade design infiltration rate shall be rounded down to the nearest rate in the sizing table.
- The design ponding depth shall be rounded down to the nearest depth in the sizing table, or sizing factors may be linearly interpolated for intermediate ponding depths (e.g., between 3 and 4 inches ponding).

Table [5-185.21](#). On-site List Sizing for Infiltrating Bioretention with and without Underdrains.

Bioretention Configuration	Average Ponding Depth	Subgrade Soil Design Infiltration Rate	Sizing Factor for Facility Bottom Area	
			Without Underdrain ^a	With Underdrain ^b
Sloped sides	2 inches	0.15 inch/hour	NA ^c	8.9% 6.8% ^d
		0.3 inch/hour	4.7% 4.5% ^e	5.2% 5.0% ^d
		0.6 inch/hour	4.5%	5.0% 5.0%
		1.0 inch/hour	4.5%	5.0%
		2.5 inch/hour	4.5%	5.0%
	6 inches	0.15 inch/hour	NA ^{c,f}	5.6% 4.7% ^d
		0.3 inch/hour	3.5%	3.9%
		0.6 inch/hour	3.5%	3.9%
		1.0 inch/hour	3.5%	3.9%
		2.5 inch/hour	3.5%	3.9%

Table 5.21 (continued). On-site List Sizing for Infiltrating Bioretention with and Without Underdrains.

Bioretention Configuration	Average Ponding Depth	Subgrade Soil Design Infiltration Rate	Sizing Factor for Facility Bottom Area	
			Without Underdrain ^a	With Underdrain ^b
Sloped sides (continued)	12 inches	0.15 inch/hour	NA ^{c,f}	2.8% 3.2% ^d
		0.3 inch/hour	NA ^f	2.6% 3.9%
		0.6 inch/hour	2.3%	2.6%
		1.0 inch/hour	2.3%	2.6%
		2.5 inch/hour	2.3%	2.6%
Vertical sides	6 inches	0.15 inch/hour	NA ^{c,f}	9.2% 7.2% ^d
		0.3 inch/hour	5.3% 5.0% ^e	5.9% 5.6% ^d
		0.6 inch/hour	5.0% ^g	5.6% 5.6% ^g
		1.0 inch/hour	5.0% ^g	5.6% ^g
		2.5 inch/hour	5.0% ^g	5.6% ^g
	12 inches	0.15 inch/hour	NA ^{c,f}	7.4% 5.7% ^d
		0.3 inch/hour	NA ^f	5.6%
		0.6 inch/hour	5.0%	5.6%
		1.0 inch/hour	5.0%	5.6%
		2.5 inch/hour	5.0%	5.6%

NA – not applicable.

^a Sizing factors are based on achieving a minimum wetted surface area of 5 percent, unless otherwise noted.

^b Sizing factors are based on a minimum wetted surface area of 5 percent multiplied by a factor of 1.11, unless otherwise noted.

^c Underdrain systems shall be installed if the subgrade soils have a measured infiltration rate of less than 0.6 inch per hour (note that the infiltration rates listed in the table are design rates).

^d Sizing factor increased to the sized required to meet the On-site Performance Standard for a pre-developed condition of forest on till and multiplied by a factor of 1.11.

^e Sizing factor increased beyond the minimum wetted surface area of 5 percent to meet the On-site Performance Standard for a pre-developed condition of forest on till.

^f Ponding depth and infiltration rate combination do not achieve drawdown requirements.

^g To maximize flow control benefit, 12 inch vertical side walls are recommended for design infiltration rates exceeding 0.3 inch per hour.

Bioretention Facility Bottom Area = Contributing Hard Surface Area x Factor (%) / 100.

Hard Surface Area Managed = Bioretention Facility Bottom Area ÷ Factor (%) / 100.

The facility shall meet the general requirements for infiltrating bioretention outlined in this section plus the following specific requirements:

- The bottom area shall be sized using the applicable sizing factor.
- It is preferred that the bottom area is flat, but up to 3 percent slope is permitted.
- For facilities with sloped sides, the side slopes within the ponded area shall be no steeper than 2.5H:1V.
- For facilities without underdrains, the bioretention soil depth shall be a minimum of 12 inches for flow control and 18 inches for water quality treatment. For facilities with underdrains, the amended soil shall have a minimum depth of 18 inches.

- The average ponding depth for the cell shall be no less than the selected ponding depth.
- No Low-permeability or impermeable liner shall not be used except to protect-adjacent roads, foundations, slopes, utilities, or other infrastructure from excessive hydrologic loading. Liner shall not be used across the entire facility bottom.

The *bottom area* for the cell is calculated as a function of the hard surface area routed to it. As an example, the bottom area of the bioretention cell with vertical sides would be equal to 5.3 percent of the hard surface area routed to it when the ponding depth is an average of 6 inches and the design infiltration rate is equal to greater than 0.3 inch per hour.

For facilities with sloped sides, top area is calculated as a function of the cell bottom area and the side slopes up to the total facility depth (i.e., ponding and freeboard depth).

Pre-sized Approach for Flow Control and Water Quality Treatment

The Pre-sized Approach may be used for projects with new and replaced hard surface areas up to 10,000 square feet. Under the Pre-sized Approach (refer to *Section 4.1.2*), simple equations are used to calculate the size of “pre-designed” bioretention facilities subject to specific design requirements (e.g., side slope, ponding depth). Sizing factors and equations for infiltrating bioretention without underdrains and with underdrains are provided in Tables [5-195.22](#) and [5-205.23](#), respectively. Note that the modeling conducted to develop sizing factors and equations for bioretention with underdrains did not include infiltration to underlying soil due to modeling constraints at the time of publication.

Pre-sized infiltrating bioretention facilities without underdrains may be used to achieve the Pre-developed Pasture, Peak Control, and Water Quality Treatment Standards. Pre-sized infiltrating bioretention facilities with underdrains may be used to achieve the Peak Control and Water Quality Treatment Standards. Sizing factors are organized by side slopes (i.e., sloped sides or vertical sides), performance standard, facility ponding depth, subgrade soil design infiltration rate (for facilities without underdrains), and contributing area. To select the appropriate sizing factor or equation:

- The design ponding depth shall be rounded down to the nearest depth in the sizing table, or sizing factors may be linearly interpolated for intermediate ponding depths (e.g., between 6 and 12 inches ponding).
- For facilities without underdrains, the subgrade design infiltration rate shall be rounded down to the nearest infiltration rate in the pre-sized table (i.e., 0.15, 0.3, 0.6, 1.0, or 2.5 inches per hour).

Table 5.195.22. Pre-sized Sizing Factors and Equations for Infiltrating Bioretention Without Underdrains.

Bioretention Configuration	Average Ponding Depth	Subgrade Soil Design Infiltration Rate	Contributing Area (sf)	Sizing Factor/Equation for Facility Bottom Area		
				Pre-developed Pasture Standard	Peak Control Standard	Water Quality Treatment Standard ^a
Sloped sides	2 inches	0.15 inch/hour	≤2,000	37.8% <u>22.9%</u>	NP	40.3% <u>8.8%</u>
			2,001 – 10,000	$[0.2132 \times A] + 325.2$ $[0.1600 \times A] + 139.6$		
		0.3 inch/hour	≤2,000	29.7% <u>18.4%</u>	NP	8.4% <u>6.9%</u>
			2,001 – 10,000	$[0.1727 \times A] + 246.6$ $[0.1319 \times A] + 106$		
		0.6 inch/hour	≤2,000	41.7% <u>9.5%</u>	NP	4.4% <u>3.1%</u>
			2,001 – 10,000	$[0.0786 \times A] + 76.1$ $[0.0756 \times A] + 38.8$		
	1.0 inch/hour	≤2,000	4.3% <u>8.3%</u>	NP	3.8% <u>2.7%</u>	
		2,001 – 10,000	$[0.0301 \times A] + 26.2$ $[0.0650 \times A] + 34.7$			
	2.5 inch/hour	≤2,000	4.3% <u>3.6%</u>	NP	4.5% <u>1.3%</u>	
		2,001 – 10,000	$[0.0301 \times A] + 26.2$ $[0.0251 \times A] + 19.7$			
	6 inches	0.15 inch/hour	≤ 2,000	NA ^b	NA ^b	NA ^b
			2,001 – 10,000			
		0.3 inch/hour	≤2,000	13.9% <u>10.4%</u>	47.7% <u>14%</u>	4.7% <u>1.5%</u>
			2,001 – 10,000	$[0.0981 \times A] + 80$ $[0.0830 \times A] + 38.7$		
		0.6 inch/hour	≤2,000	8.5% <u>6.2%</u>	12.2% <u>9.6%</u>	3.0% <u>0.7%</u>
			2,001 – 10,000	$[0.0653 \times A] + 38.2$ $[0.0560 \times A] + 10.2$		
		1.0 inch/hour	≤2,000	7.3% <u>5.3%</u>	40.7% <u>8.6%</u>	2.6% <u>0.7%</u>
			2,001 – 10,000	$[0.0561 \times A] + 32.7$ $[0.0480 \times A] + 8.8$		
2.5 inch/hour		≤2,000	2.9% <u>2.1%</u>	5.3% <u>4.7%</u>	1.0% <u>0.5%</u>	
		2,001 – 10,000	$[0.0214 \times A] + 12$ $[0.0177 \times A] + 3.5$			
12 inches	0.15 inch/hour	≤2,000	NA ^b	NA ^b	NA ^b	
		2,001 – 10,000				
	0.3 inch/hour	≤2,000	NA ^b	NA ^b	NA ^b	
		2,001 – 10,000				
	0.6 inch/hour	≤2,000	4.3% <u>3.3%</u>	8.2% <u>7.0%</u>	4.7% <u>1.1%</u>	
		2,001 – 10,000	$[0.0444 \times A] - 3.6$ $[0.0395 \times A] - 16.1$			
	1.0 inch/hour	≤2,000	3.7% <u>2.8%</u>	7.2% <u>6.1%</u>	4.5% <u>1.0%</u>	
		2,001 – 10,000	$[0.038 \times A] - 4$ $[0.0335 \times A] - 13.3$			

Table 5.195.22 (continued). Pre-sized Sizing Factors and Equations for Infiltrating Bioretention Without Underdrains.

Bioretention Configuration	Average Ponding Depth	Subgrade Soil Design Infiltration Rate	Contributing Area (sf)	Sizing Factor/Equation for Facility Bottom Area		
				Pre-developed Pasture Standard	Peak Control Standard	Water Quality Treatment Standard ^a
Sloped sides (continued)	12 inches (continued)	2.5 inch/hour	≤2,000	1.2%1.0%	3.3%2.8%	0.6%0.4%
			2,001 – 10,000	$[0.0142 \times A] - 5.5$ $[0.0110 \times A] - 3$		
Vertical sides	6 inches	0.15 inch/hour	≤2,000	NA ^b	NA ^b	NA ^b
			2,001 – 10,000			
		0.3 inch/hour	≤2,000	20.2%15.8%	20.8% 16.8%	6.6%
			2,001 – 10,000	$[0.1106 \times A] + 182.2$ $[0.0957 \times A] + 126$		
		0.6 inch/hour	≤2,000	13.6%10.7%	15.4% 13.3%	4.5%
			2,001 – 10,000	$[0.0753 \times A] + 124.7$ $[0.0671 \times A] + 81.2$		
	1.0 inch/hour	≤2,000	11.9%9.3%	13.7% 11.9%	4.0%	
		2,001 – 10,000	$[0.0657 \times A] + 108.8$ $[0.0585 \times A] + 70.5$			
	2.5 inch/hour	≤2,000	5.4%4.1%	7.3%6.6%	2.0%1.9%	
		2,001 – 10,000	$[0.0280 \times A] + 24.6$ $[0.0297 \times A] + 49.4$			
	12 inches	0.15 inch/hour	≤2,000	NA ^b	NA ^b	NA ^b
			2,001 – 10,000			
		0.3 inch/hour	≤2,000	NA ^b	NA ^b	NA ^b
			2,001 – 10,000			
		0.6 inch/hour	≤2,000	10.2%8.1%	11.2% 9.7%	3.6%
			2,001 – 10,000	$[0.0582 \times A] + 90.1$ $[0.0518 \times A] + 57.6$		
		1.0 inch/hour	≤2,000	9.0%7.0%	10.1% 8.6%	3.2%
			2,001 – 10,000	$[0.0513 \times A] + 79.1$ $[0.0454 \times A] + 49.4$		
2.5 inch/hour		≤2,000	4.4%3.0%	5.7%4.6%	1.6%	
		2,001 – 10,000	$[0.0237 \times A] + 10.9$ $[0.0255 \times A] + 38$			

NP – sizing factors not provided; NA – not applicable; A – contributing hard surface area; sf – square feet.

For Sizing Factors: Bioretention Facility Bottom Area = Contributing Hard Surface Area x Factor (%) / 100.

Hard Surface Area Managed = Bioretention Facility Bottom Area ÷ Factor (%) / 100.

For Sizing Equations: Bioretention Facility Bottom Area (sf) = [Factor x A (sf)] + Integer.

Hard Surface Area Managed (sf) = [Bioretention Bottom Area (sf) - Integer] ÷ Factor.

^a Pre-sized Approach may be used to meet basic water quality treatment. Enhanced water quality treatment may be achieved if soil suitability criteria are met (refer to Section 4.5.2).

^b Ponding depth and infiltration rate combination do not achieve drawdown requirements.

Table 5.205.23. Pre-sized Sizing Factors and Equations for Infiltrating Bioretention with Underdrains.

Bioretention Configuration	Average Ponding Depth	Contributing Area (sf)	Sizing Factor/Equation for Facility Bottom Area		
			Pre-developed Pasture Standard	Peak Control Standard	Water Quality Treatment
Sloped sides	2 inches	0 – 10,000	NA ^a	NA ^a	1.3%
	6 inches	≤ 2,000	NA ^a	NA ^a	[0.0059 x A] - 3.2153
		2,001 – 10,000			[0.0097 x A] - 11.2974
	12 inches	≤ 2,700	NA ^a	3.0% to 4.5% ^b	0.4% to 2.0%
2,701 – 10,000		[0.0052 x A] - 12.0924			
Vertical sides	6 inches	0 – 10,000	NA ^a	NA ^a	1.2% to 1.3%
	12 inches	0 – 10,000	NA ^a	4.5% ^b	1.0% to 1.4%

NA – not applicable

For Sizing Factors: Bioretention Facility Bottom Area = Contributing Hard Surface Area x Factor (%) / 100.

Hard Surface Area Managed = Bioretention Facility Bottom Area ÷ Factor (%) / 100.

For Sizing Equations: Bioretention Facility Bottom Area (sf) = [Factor x A (sf)] + Integer.

Hard Surface Area Managed (sf) = [Bioretention Bottom Area (sf) – Integer] ÷ Factor.

^a Bioretention facilities with underdrains are not capable of achieving the standard unless orifice controls are used. The Modeling Approach may be used to more accurately represent additional performance due to infiltration, which is neglected in the Pre-Sized approach.

^b When used to meet the Peak Control Standard, the facility size shall not be larger than prescribed by the sizing factor (or sizing factor range) because flow control performance may be diminished for larger facilities (larger facilities will not pond water sufficiently to slow flows).

To use these pre-sized facilities to meet performance standards, the bioretention facility shall meet the general requirements outlined in this section plus the following specific requirements:

- The bottom area shall be sized using the applicable sizing factor or equation.
- It is preferred that the bottom area is flat, but up to 3 percent slope is permitted.
- For facilities with sloped sides, the side slopes within the ponded area shall be no steeper than 2.5H:1V.
- For facilities without underdrains, the bioretention soil depth shall be a minimum of 12 inches for flow control and 18 inches for water quality treatment. For facilities with underdrains, the amended soil shall have a minimum depth of 18 inches.
- The average ponding depth for the cell shall be no less than the selected ponding depth.

The bottom area for the cell is calculated as a function of the hard surface area routed to it. As an example, to meet the Pre-developed Pasture Standard using a bioretention facility without an underdrain, with sloped sides, and an average ponding depth of 6 inches for a contributing area between 2,000 and 10,000 square feet where the design subgrade infiltration rate is between 1 and 2.49 inches per hour, the bioretention bottom area would be calculated as: 0.0561 x contributing hard surface area + 32.7. All area values shall be in

square feet. The bottom area of the same facility sized for a contributing area less than 2,000 square feet would be equal to 7.3 percent of the hard surface area routed to it.

Modeling Approach for On-site Performance Standard, Flow Control, and Water Quality Treatment

When using continuous simulation hydrologic modeling to size bioretention cells, the assumptions listed in Table 5-215.24 shall be applied. [Refer to the Approval Status of Continuous Simulation Models section of the SWMMWW for a list of currently approved models.](#) Infiltrating bioretention can be modeled as a layer of soil (with specified design infiltration rate and porosity) with ponding, infiltration to underlying soil and overflow. The contributing area, cell bottom area, and ponding depth should be iteratively sized until the Minimum Requirements for On-site Stormwater Management, Flow Control and/or Treatment are met (refer to *Volume 1 – Project Minimum Requirements*) [or where it has been determined by the Director that there is no off-site point of discharge for the project, the requirements of Section 4.3.2 are met.](#) General sizing procedures for infiltration facilities are presented in *Section 4.5.1*.

Table 5-215.24. Continuous Modeling Assumptions for Infiltrating Bioretention.

Variable	Assumption
Precipitation Series	Seattle 158-year, 5-minute series
Computational Time Step	5 minutes
HSPF Parameters	LSUR, SLSUR, NSUR shall be adjusted per Appendix F
Inflows to Facility	Surface flow and interflow from total drainage area (including impervious and pervious contributing areas) routed to facility
Precipitation and Evaporation Applied to Facility	Yes. WWHM and MGSFlood both apply precipitation and evaporation to the facility automatically. If model does not apply precipitation and evaporation to facility automatically, then modelers shall add the facility area to the post developed impervious contributing area to account for this additional precipitation and evaporation (note that this will underestimate the evaporation of ponded water).
Bioretention Soil Infiltration Rate	The design infiltration rate shall be 6 inches per hour.
Bioretention Soil Porosity	A 30% porosity shall be assumed for facility sizing.
Bioretention Soil Depth	For facilities without underdrains, the soil shall have a minimum of 12 inches for flow control and minimum of 18 inches for water quality treatment. For facilities with underdrains, the soil shall have a minimum depth of 18 inches.
Subgrade Soil Design Infiltration Rate	Design infiltration rate (<i>Section 4.5.2, Appendix D</i>)
Liner	The horizontal footprint of a liner shall be excluded from the infiltration area (bottom area and/or side slopes)
Underdrain (if required)	If the underdrain is elevated above the bottom extent of the aggregate layer, water stored in the aggregate below the underdrain invert may be modeled to provide storage and infiltrate to subsurface soil. For the purposes of this manual, underdrains meeting the bedding requirements shown in Figures 5.135-12 and 5.145-13 are considered “elevated” by 6 inches. In order to model the underdrain with underlying storage and infiltration, the aggregate gravel reservoir shall extend across the bottom of the facility. The underdrain pipe could be further elevated for improved flow control performance.

Variable	Assumption
Overflow Structure	The overflow elevation shall be set at the maximum ponding elevation (excluding freeboard). It may be modeled as weir flow over a riser edge. Note that the total facility depth (including freeboard) shall be sufficient to allow water surface elevation to rise above the overflow elevation to provide head for discharge.

5.4.4.7. *Minimum Construction Requirements*

During construction, it is critical to prevent clogging and over-compaction of the subgrade and bioretention soils. Minimum requirements associated with bioretention facility construction include the following:

- Place bioretention soil per the requirements of City of Seattle Standard Specifications.
- Do not excavate or place soil during wet or saturated conditions.

Refer to the Puget Sound LID Manual for additional guidance on bioretention construction.

5.4.4.8. *Operations and Maintenance Requirements*

Bioretention O&M requirements are provided in *Appendix G* (BMP No. [2322](#)).

5.4.5. Rain Gardens

5.4.5.1. Description

Rain gardens are shallow, landscaped depressions with compost amended soil or imported bioretention soil and plants adapted to the local climate and soil moisture conditions. Stormwater is stored as surface ponding before it filters through the underlying amended soil. Stormwater that exceeds the surface storage capacity overflows to an adjacent drainage system. Treated water is infiltrated into the underlying soil. Rain gardens can be individual cells or multiple cells connected in series.

Rain gardens are infiltration BMPs and shall be designed according to the requirements in *Section 3.2* and *Section 4.5*.

Rain gardens are similar to infiltrating bioretention facilities (refer to *Section 5.4.4*) with the following exceptions:

- Rain gardens may only be used to meet the On-site List Approach.
- Rain gardens cannot be used on projects choosing to meet the On-site Performance Standard or projects that trigger flow control or water quality treatment requirements.
- Rain gardens may not have a liner or underdrain.
- The maximum ponding depth is 6 inches [except for in the right-of-way where the maximum ponding depth is 3 inches.](#)
- Rain gardens may have compost amended soil rather than imported bioretention soil.
- There are no presettling requirements.
- Within the right-of-way, rain gardens are not an allowable BMP if incidental runoff from PGHS exceeds 10 percent of the contributing area.
- Observation ports are not required.

5.4.5.2. Performance Mechanisms

Like infiltrating bioretention, rain gardens provide flow control via detention, attenuation, and losses due to infiltration, interception, evaporation, and transpiration. Some water quality treatment is provided through sedimentation, filtration, adsorption, uptake, or biodegradation and transformation of pollutants by soil organisms, soil media, and plants (note that rain gardens cannot be used to achieve water quality treatment).

5.4.5.3. Applicability

As shown in the table below, rain gardens can only be applied to meet the on-site stormwater management requirement using the On-site List Approach. To meet flow control, water quality treatment or the On-site Performance Standards, an infiltrating bioretention facility may be used (refer to *Section 5.4.4*).

BMP	On-site		Flow Control			Water Quality				Conveyance
	List	Standard	Forest	Pasture	Peak	Basic	Enhanced	Oil Control	Phosphorus	
Rain garden	✓									✓ ^a

^a Rain gardens may be connected in series, with the overflows from upstream cells directed to downstream cells to provide conveyance.

5.4.5.4. Site Considerations

Site considerations for the applicability of rain gardens are provided in *Section 3.2* and *Section 4.5*. Refer to *Appendix C* for additional infeasibility criteria for the On-site List Approach.

5.4.5.5. Design Criteria

This section provides a description, recommendations, and requirements for the components of rain gardens. Typical components of a rain garden are shown in Figure [5.165-14](#). Design criteria are provided in this section for the following elements:

- Contributing area
- Flow entrance
- Ponding area
- Compost amended or imported bioretention soil
- Subgrade
- Overflow
- Plants
- Mulch layer

For additional guidance on rain garden design and construction, refer to the *Rain Garden Handbook for Western Washington Homeowners* (WSU 2013, or as revised). Sizing guidance provided in the handbook is not applicable (refer to *Section 5.4.5.6* for sizing requirements).

Contributing Area

A single rain garden cell or a series of cells shall not receive runoff from more than 5,000 square feet of impervious area. This area limitation is to ensure that rain gardens are small-scale and distributed. In no case shall the area contributing runoff to a rain garden consist of more than 10 percent PGHS within the right-of-way.

The rain garden cell area should be sized for the contributing area routed to the cell. It is recommended that cells not be oversized because the vegetation in oversized cells may not receive sufficient storm water runoff for irrigation, increasing maintenance requirements.

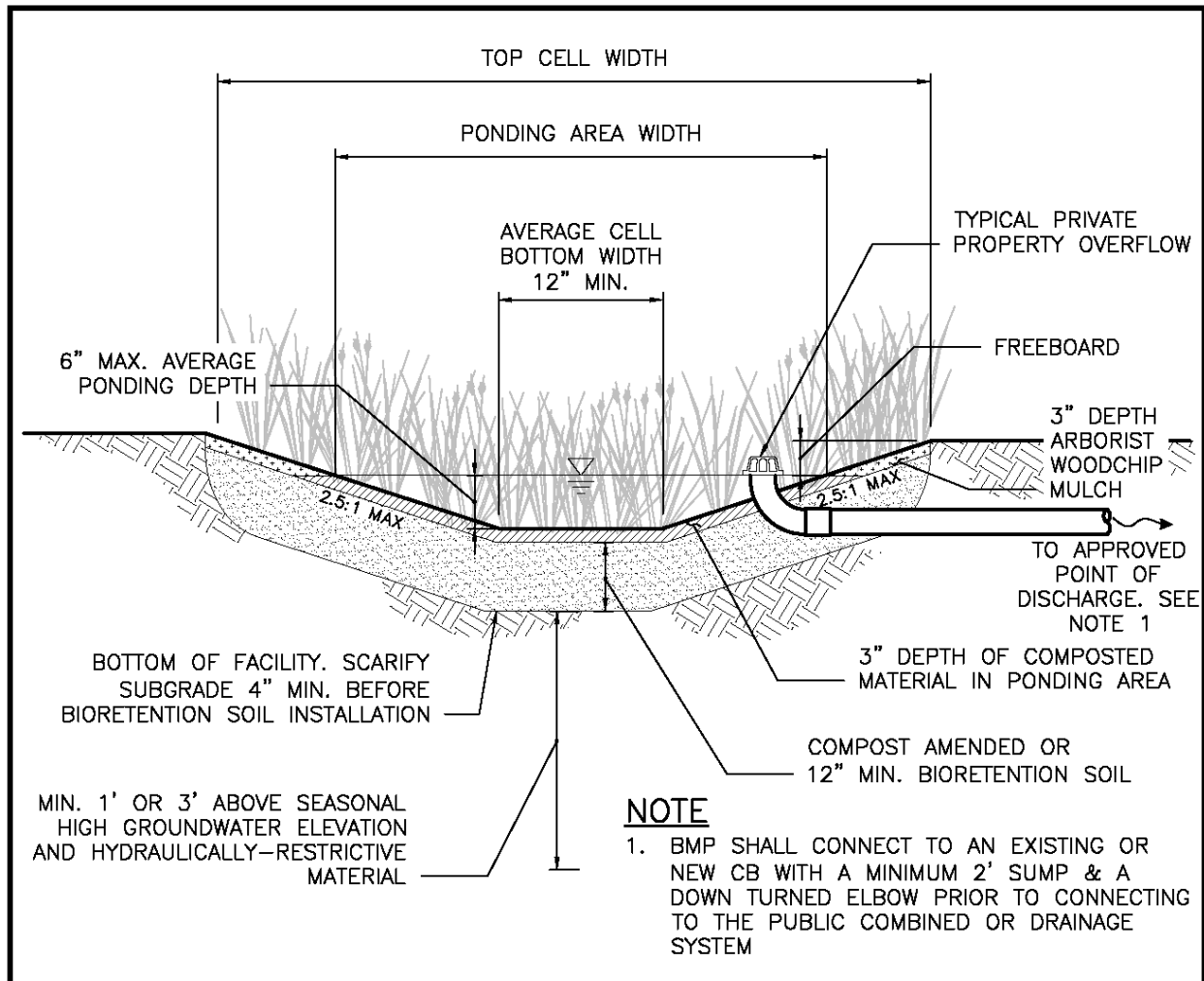

Figure 5.165-14. Typical Rain Garden.

Stormwater flows from other areas (beyond the area for which the rain garden is sized) should be bypassed around the cell in order to reduce sediment loading to the cell and the potential for clogging. While it is preferred that rain gardens be sized to manage only the area draining to the cell, excess flows may be routed through a rain garden with the following limitations:

- The maximum impervious drainage area that may be routed to a rain garden shall not exceed twice the area for which it is sized, limited to a maximum of 5,000 square feet. Additional runoff contributions from pervious areas are acceptable. No on-site stormwater management credit is given for runoff from areas beyond the design area.
- Additional runoff routed to a rain garden shall be clearly noted on submitted plans.

Flow Entrance

Flow entrances must-shall be sized to capture flow from the drainage area and designed to both reduce the potential for clogging at the inlet and prevent inflow from causing erosion in the rain garden cell. Four primary types of flow entrances can be used for rain gardens:

- Dispersed flow (e.g., vegetated buffer strips)

- Sheet flow
- Curb cuts
- Concentrated flow (e.g., piped flow)

Vegetated buffer strips are the preferred entrance type because they slow incoming flows and provide initial settling of particulates. Refer to the Puget Sound LID Manual for guidance on flow entrances.

The minimum requirements associated with the flow entrance design include the following:

- For rain gardens ~~in the right-of-way~~, the flow entrance elevation shall be above the overflow elevation.
- For sheet flow into a rain garden, a minimum 1-inch drop from the edge of a contributing hard surface to the vegetated flow entrance is required. This drop is intended to allow for less frequent maintenance by allowing some sediment/debris buildup at the edge where flow enters the rain garden.
- The following requirements apply to parking lot curb cut flow entrances:
 - The minimum curb cut width shall be 8 inches.
 - The curb cut ~~must~~ shall have either a minimum of 8 percent slope from the outer curb face extending to a minimum of 12 inches beyond the back of curb, or provide a minimum of 2-inch vertical drop from the back of curb to the vegetated surface of the cell.
- If concentrated flows are entering the cell (e.g., pipe or curb cut), flow energy dissipation (e.g., rock/cobble pad or flow dispersion weir) shall be incorporated to reduce the potential for erosion at the inlet.

Ponding Area

The ponding area provides surface storage for storm flows and the first stages of pollutant treatment within the cell. The minimum requirements associated with the cell ponding area design include the following:

- The bottom area of a cell shall be no less than 4 square feet, except where used to manage sidewalk runoff in the ROW planting strip where the minimum area can be reduced to 2 square feet if needed to eliminate check dams.
- The average ponding depth shall be no less than 2 inches and no more than 6 inches.
- The maximum planted side slope is 2.5H:1V. If total cell depth exceeds 3 feet, the maximum planted side slope is 3H:1V. If steeper sides are necessary, rockery, concrete walls, or steeper soil wraps may be used.
- If berming is used to achieve the minimum top cell elevation needed to meet ponding depth and freeboard needs, maximum berm slope is 2.5H:1V, and minimum berm top width of is 6 inches. Soil used for berming where the permanent restoration is landscape shall be imported bioretention soil or amended subgrade soil and compacted to a minimum of 90 percent dry density.
- For trees planted within or alongside slopes of a rain garden cell, the maximum side slope around the tree is 1H:1V.

- The average bottom width for the rain garden shall be no less than 12 inches.
- The bottom slope shall be no more than 3 percent.

[Refer to CAM 1190 for additional guidance for siting rain gardens within the right-of-way.](#)

~~To address traffic and pedestrian safety concerns, the following additional minimum requirements apply to rain gardens in the right-of-way:~~

- ~~• The following minimum setbacks shall be provided:~~
 - ~~○ 1.5 feet minimum from face of curb to top of slope on non-arterial streets for rain gardens with average ponding depths of 3 inches or less~~
 - ~~○ 2 feet minimum from face of curb to top of slope on non-arterial streets for rain gardens with average ponding depths greater than 3 inches~~
 - ~~○ 2 feet minimum from face of curb to top of slope on non-principal arterial streets~~
 - ~~○ 4 feet minimum from face of curb to top of slope for principal arterial streets~~
 - ~~○ 1 foot minimum from edge of sidewalk to top of slope~~
- ~~• A minimum of one access path across planting strip shall be provided between the street and public sidewalk for each parcel. Access paths shall be a minimum of 5 feet wide. It is preferred that the access path is within 15 feet of the structure access point (such as path to doorway or stairs).~~
- ~~• Rain gardens shall not impact driveway/alley access. A 2-foot minimum setback shall be provided from the pavement edge of the driveway curb cut wing to the top (top of slope) of rain garden.~~
- ~~• A two foot minimum setback shall be provided from the edge of paving for the public sidewalk/curb ramp at the intersection to the top of slope of the rain garden. Curb ramp improvements are required whenever the construction of rain gardens and associated street improvements remove pavement within the crosswalk area of the street or sidewalk, impact curbs, sidewalks, curb ramps, curb returns or landings within the intersection area, or affect access to or use of a public facility.~~

Compost Amended or Imported Bioretention Soil

Proper soil specification, preparation, installation, and maintenance are critical factors for rain garden performance. To meet rain garden soil requirements, the subgrade soil may be amended with compost or the subgrade soil may be over excavated and replaced with imported bioretention soil.

To determine if the subgrade soil is suitable for amending with compost, a simple soil texture test can be performed. When digging the test hole for the subgrade soil infiltration test do the following:

- Squeeze moist soil into a ball. If the soil falls apart or can be broken up easily and is gritty feeling, this suggests a sandier, well-draining soil. This type of soil is suitable for amending and use in the rain garden.
- If the soil is sticky, smooth, and forms a ball that can be worked like modeling clay, this suggests poor-draining soil with high clay content. If the soil is smooth, pliable but

not sticky then it is likely a silty soil and moderate to poor draining. These soils are less suitable for amending and shall be replaced with 12 inches of imported bioretention soil per City of Seattle Standard Specification 7-21 (refer to *Section 5.4.4.5*).

- If the soil is dry, add water a few drops at a time, break down the chunks to work the water into soil, and then perform the soil texture test.

If the subgrade soil is suitable, amend existing site topsoil or subsoil per *Section 5.1.5.1*.

Subgrade

The minimum measured subgrade infiltration rate for rain gardens is 0.3 inch per hour.

If subgrade soil is over excavated to place imported bioretention soil, the subgrade soil surface can become smeared and sealed by excavation equipment during construction. The design shall require scarification or raking of the side walls and bottom of the rain garden excavation to a minimum depth of 4 inches after excavation to restore infiltration rate.

Overflow

A rain garden shall have an overflow. The rain garden overflow can be provided by a drain pipe, earthen channel or curb cut installed at the designed maximum ponding elevation and connected to a downstream BMP or an approved point of discharge.

The minimum requirements associated with the overflow design include the following:

- Overflows shall convey any flow exceeding the capacity of the cell unless designed to fully infiltrate all flows for the full, required simulation period. Plans shall indicate surface flow paths in case of failure of the BMP (refer to *Section 4.3.3*). ~~per *Section 4.3.4*.~~
- Freeboard shall be provided to ensure that overflows are safely conveyed to an approved point of discharge without flooding adjacent properties or sidewalks. The minimum freeboard measured from the invert of the overflow point (e.g., standpipe, earthen channel, curb cut) to the lowest overtopping elevation of the cell is 2 inches for contributing drainage areas less than 3,000 square feet and 4 inches for contributing drainage areas from 3,000 square feet to 5,000 square feet.
- The drain pipe, if used, shall have a minimum diameter of 4 inches.
- For cells in the right-of-way with ponding depths of 3 inches or less (e.g., Sidewalk Projects), it is acceptable to allow overflow over the curb to the roadway conveyance system.
- If the cell will receive flows from areas beyond the area for which the rain garden is sized (refer to the *Contributing Area* subsection), the overflow conveyance infrastructure shall safely convey runoff from the total drainage area.

Plants

In general, the predominant plantings used in rain gardens are species adapted to stresses associated with wet and dry conditions. Soil moisture conditions will vary within the rain garden from saturated (bottom of cell) to relatively dry (rim of cell). Accordingly, wetland

plants may be planted in the lower areas and drought-tolerant species planted on the perimeter of the rain garden or on mounded areas.

The minimum requirements associated with the vegetation design include the following:

- The plans shall specify that vegetation coverage of plants will achieve 90 percent coverage within 2 years. For this purpose, cover is defined as canopy cover and should be measured when deciduous plants are in bloom.
- The plants must-shall be sited according to sun, soil, wind and moisture requirements.
- At a minimum, provisions shall be made for supplemental irrigation/watering during the first two growing seasons following installation and in subsequent periods of drought.
- Plants for rain gardens sited in the right-of-way shall be selected from bioretention plant list (*Appendix E*).

Refer to the Rain Garden Handbook for Western Washington Homeowners and the Puget Sound LID Manual for guidance on plant selection and recommendations for increasing survival rates.

Mulch Layer

Properly selected organic mulch material reduces weed establishment, regulates soil temperatures and moisture, and adds organic matter to the soil. Compost and arborist wood chip mulch are required for different applications within the rain garden cell. Compost mulch is an excellent slow-release source of plant nutrients and does not float, but compost does not suppress weed growth as well as bulkier, higher carbon mulches like arborist wood chips. Arborist wood chips are superior to bark mulch in promoting plant growth, feeding beneficial soil organisms, reducing plant water stress, and maintaining surface soil porosity.

Organic mulch shall consist of the following:

- Compost (per City of Seattle Standard Specification 9-14.4(8)~~6b~~) in the bottom of the rain garden cell and up to the ponding elevation
- Arborist wood chip mulch (per City of Seattle Standard Specification 9-14.4(4)) on cell slopes above the ponding elevation and the around the rim area
- A minimum of 2 inches and a maximum of 3 inches for both types of organic mulch

~~In~~ Rain garden designs may use aggregate mulch. This may be desirable in areas where higher flow velocities are anticipated, an aggregate mulch may be used to dissipate flow energy and protect underlying soil. Aggregate mulch varies in size and type, but 1- to 1.5-inch gravel (rounded) decorative rock is typical. Aggregate mulch shall be washed (free of fines) and the area covered with aggregate mulch shall not exceed one fourth of the rain garden bottom area.

As an alternative to mulch, a dense groundcover may be used. Mulch is required in conjunction with the groundcover until groundcover is established. Mulch is not required for turf-vegetated cells.

5.4.5.6. BMP Sizing

Sizing for On-site List Approach

Rain gardens may be selected to meet the On-site List Requirement (refer to *Section 3.3.1* and *Appendix C* for infeasibility criteria). To meet the requirement rain gardens shall be sized according to the sizing factors provided in Table 5-225.25. Sizing factors are based on achieving a minimum wetted surface area of 5 percent of the contributing area or meeting the On-site Performance Standard for a pre-developed condition of forest on till (whichever is greater).

Factors are organized by cell ponding depth, cell side slope, and subgrade design infiltration rate. To select the appropriate sizing factor:

- The subgrade design infiltration rate shall be rounded down to the nearest rate in the sizing table.
- The ponding depth shall be rounded down to the nearest depth in the sizing table, or sizing factors may be linearly interpolated for intermediate ponding depths (e.g., between 3 and 4 inches ponding).

The rain garden shall meet the general requirements for rain gardens outlined in this section plus the following specific requirements:

- The bottom area shall be sized using the applicable sizing factor.
- It is preferred that the bottom area be flat, but up to 3 percent slope is permitted.
- For facilities with sloped sides, the side slopes within the ponded area shall be no steeper than 2.5H:1V.
- The rain garden soil depth shall be a minimum of 12 inches.
- The average ponding depth for the cell shall be no less than the selected ponding depth.

The *bottom* area for the rain garden is calculated as a function of the hard surface area routed to it. As an example, the bottom area of the rain garden would be equal to 3.5 percent of the hard surface area routed to it when the design infiltrating rate is 0.6 inch per hour and the ponding depth is an average of 6 inches. For facilities with sloped sides, top area is calculated as a function of the cell bottom area and the side slopes up to the total rain garden depth (i.e., ponding and freeboard depth).

Table 5-225.25. On-site List Sizing for Rain Gardens.

Bioretention Rain Garden Configuration	Average Ponding Depth	Subgrade Soil Design Infiltration Rate	Sizing Factor for Rain Garden Bottom Area ^a
			On-site List
Sloped sides	2 inches	0.15 inch/hour	6.1% 8.0% ^b
		0.3 inch/hour	4.5% 4.7% ^b
		0.6 inch/hour	4.5%
		1.0 inch/hour	4.5%
		2.5 inch/hour	4.5%

Table 5-225.25 (continued). On-site List Sizing for Rain Gardens.

Bioretention Rain Garden Configuration	Average Ponding Depth	Subgrade Soil Design Infiltration Rate	Sizing Factor for Rain Garden Bottom Area ^a
			On-site List
Sloped sides (continued)	6 inches	0.15 inch/hour	NA ^c
		0.3 inch/hour	3.5%
		0.6 inch/hour	3.5%
		1.0 inch/hour	3.5%
		2.5 inch/hour	3.5%
Vertical sides	6 inches	0.15 inch/hour	NA ^c
		0.3 inch/hour	5.0% 5.3% ^b
		0.6 inch/hour	5.0%
		1.0 inch/hour	5.0%
		2.5 inch/hour	5.0%

NA – not applicable

^a Sizing factors are based on achieving a minimum wetted surface area of 5 percent unless otherwise noted.

^b Sizing factor increased beyond the minimum wetted surface area of 5 percent to meet the On-site Performance Standard for a pre-developed condition of forest on till.

^c Ponding depth and infiltration rate combination do not achieve drawdown requirements.

Rain Garden Bottom Area = Contributing Hard Surface Area x Factor (%) / 100.

5.4.5.7. Minimum Construction Requirements

During construction, it is critical to prevent clogging and over-compaction of the subgrade, bioretention soils or amended soils. Minimum requirements associated with rain garden construction include the following:

- Amend subgrade soil per *Section 5.1* or place bioretention soil per the requirements of City of Seattle Standard Specifications.
- Do not excavate, place soil, or amend soil during wet or saturated conditions.

5.4.5.8. Operations and Maintenance Requirements

Rain garden O&M requirements are provided in *Appendix G (BMP No. 2928)*.

5.4.6. Permeable Pavement Facilities

5.4.6.1. Description

Permeable pavement is a paving system that allows rainfall to infiltrate into an underlying aggregate storage reservoir, where stormwater is stored and infiltrated to the underlying subgrade or removed by an overflow drainage system. Two categories of permeable pavement BMPs are included in this manual: permeable pavement facilities (provided in this section) and permeable pavement surfaces (provided in Section 5.6.2).

The main difference between permeable pavement facilities and permeable pavement surfaces is that permeable pavement surfaces are not intended to have a significant amount of run-on from other surfaces and they have an aggregate base with a depth as little as 3 inches where permeable pavement facilities are sized to infiltrate drainage from impervious run-on areas that are 2 to 5 times the area of the BMP and require an aggregate base storage reservoir with a minimum depth of 6 inches. The deeper reservoir course allows permeable pavement facilities to more easily meet performance standards for a larger percentage of the project because it can infiltrate runoff from other hard surfaces such as roofs. Also, in this manual, permeable pavement facilities are considered infiltrating facilities, while permeable pavement surfaces are considered a surface runoff reduction method, which makes the on-site stormwater management infeasibility criteria different.

A comparison of these BMPs is provided in Table 5.23.

Table 5.23. Comparison of Permeable Pavement Facilities and Surfaces.

Characteristic		Permeable Pavement Facility	Permeable Pavement Surface
Infiltration Facility	Subject to restrictions for infiltration facilities (e.g., setbacks, separation from groundwater)	Yes	No
On-site List	Can be used to meet the On-site Stormwater Management requirement using the On-site List Approach	Yes	Yes
Performance Standards	Can typically be designed to meet performance standards for the permeable pavement area	Yes	Low-slope installations only (up to 2%)
Run-on	Can be designed to manage (meet stormwater requirements) for stormwater runoff from other contributing areas (run-on)	Yes	No
Subsurface Check Dams	Installation on sloped subgrade requires subsurface check dams to achieve the design storage depth across the facility	Yes	High slope installations only (exceeding 5%)
Aggregate Depth	Required minimum aggregate depth	6 inches storage reservoir	3 inches aggregate subbase

A permeable pavement facility consists of a pervious wearing course (e.g., porous asphalt, pervious concrete) and an underlying storage reservoir. The storage reservoir is designed to support expected loads and store stormwater to allow time for the water to infiltrate into the underlying soil.

Due to the permeable nature of a permeable pavement facility, future application of an impervious surface (e.g., fog seal, chip seal or other types of impervious overlay) over top of the facility is prohibited.

While not explicitly addressed in this section, infiltration galleries may be allowed under impermeable pavements in lieu of permeable pavement.

5.4.6.2. Performance Mechanisms

Flow control occurs through temporary storage of stormwater runoff in the voids of the aggregate material and subsequent infiltration of stormwater into the underlying soils. Pollutant removal mechanisms include sedimentation, infiltration, filtration, adsorption, and biodegradation.

5.4.6.3. Applicability

Permeable pavement facilities can be designed to provide on-site stormwater management, flow control and/or water quality treatment. This BMP can be applied to meet or partially meet the requirements listed below.

BMP	On-site		Flow Control			Water Quality				Conveyance
	List	Standard	Forest	Pasture	Peak	Basic	Enhanced	Oil Control	Phosphorus	
Permeable Pavement Facility	✓	✓	✓	✓	✓	✓ ^a	✓ ^a		✓ ^b	

^a Underlying soil shall meet the treatment soil requirements outlined in Section 4.5.2 or a water quality treatment course shall be included per Section 5.4.6.5.

^b Refer to treatment train options for infiltration BMPs included in Section 4.4.3.2.

5.4.6.4. Site Considerations

Unlike many facilities that require dedicated space on a site, permeable pavement facilities are part of the usable lot area and can replace conventional pavements, including:

- Sidewalks and pedestrian plazas
- Pedestrian and bike trails
- Driveways
- Most parking lots
- Low volume roads, alleys, and access drives

Site considerations for the applicability of permeable pavement facilities include:

- **Setbacks and restrictions:** Permeable pavement facilities shall meet the siting and infiltration rate requirements for infiltration facilities presented in Section 3.2 and Section 4.5. For areas where permeable pavement facilities are not permitted, permeable pavement surfaces may be used because they do not take additional run-on and are not categorized as infiltration facilities (refer to Section 5.6.2).

- **Site topography:** The recommended maximum surface (wearing course) slope for permeable pavement facilities is 6 percent to allow efficient storage of water within the subbase. For vehicular traction, the maximum surface slope varies by wearing course type (refer to industry guidelines). Minimum wearing course slope shall be 1 percent unless provision is made for positive drainage in event of surface clogging.
The recommended maximum subgrade slope for permeable pavement applications is 6 percent. Subgrades that are sloped require subsurface check dams to promote storage in the subgrade (refer to *Section 5.4.6.5 – Subsurface Check Dam* and Figure [5.185-16](#)). At steeper subgrades slopes, design and construction become more complex and the construction cost increases.
- **Land use:** Because permeable pavement can clog with sediment, permeable paving facilities are not recommended where sediment and pollutant loading is unavoidable, including the following conditions:
 - Excessive sediment contamination is likely on the pavement surface (e.g., construction areas, landscaping material yards).
 - It is infeasible to prevent stormwater run-on to the permeable pavement from unstabilized erodible areas without presettling.
 - Regular, heavy application of sand is anticipated for maintaining traction during winter, or the facility is in close proximity to areas that will be sanded. A minimum 7-foot clearance is required between a permeable pavement facility and the travel lane of sanded arterial roads.
 - Sites where the risk of concentrated pollutant spills are more likely (e.g., gas stations, truck stops, car washes, vehicle maintenance areas, industrial chemical storage sites).
- **Accessibility:** As for standard pavement design, ADA accessibility issues shall be addressed when designing a permeable pavement facility, particularly when using pavers.
- Refer to *Appendix C* for additional infeasibility criteria for the On-site List Approach.

5.4.6.5. Design Criteria

This section provides descriptions, recommendations, and requirements for the common components of permeable pavement facilities. Typical components of a permeable pavement facility are shown in Figure [5.175-15](#) and an [example of](#) permeable pavement facility with check dams is shown in Figure [5.185-16](#). Some, or all, of the components may be used for a given application depending on the permeable pavement type (e.g., porous asphalt, pavers, etc.), site characteristics and restrictions, and design objectives.

Design criteria are provided in this section for the following elements:

- Contributing area
- Flow Entrance/presettling
- Wearing course
- Leveling course

- Storage reservoir
- Subgrade
- Subsurface check dams
- Overflow
- Geotextile
- Water quality treatment course (if required)
- Observation/[maintenance](#) port
- Underdrain (optional)
- [Edge treatment](#)

The structural design of permeable pavement to support anticipated loads is outside the scope of this manual.

The Puget Sound LID Manual provides additional guidance on permeable pavement design.

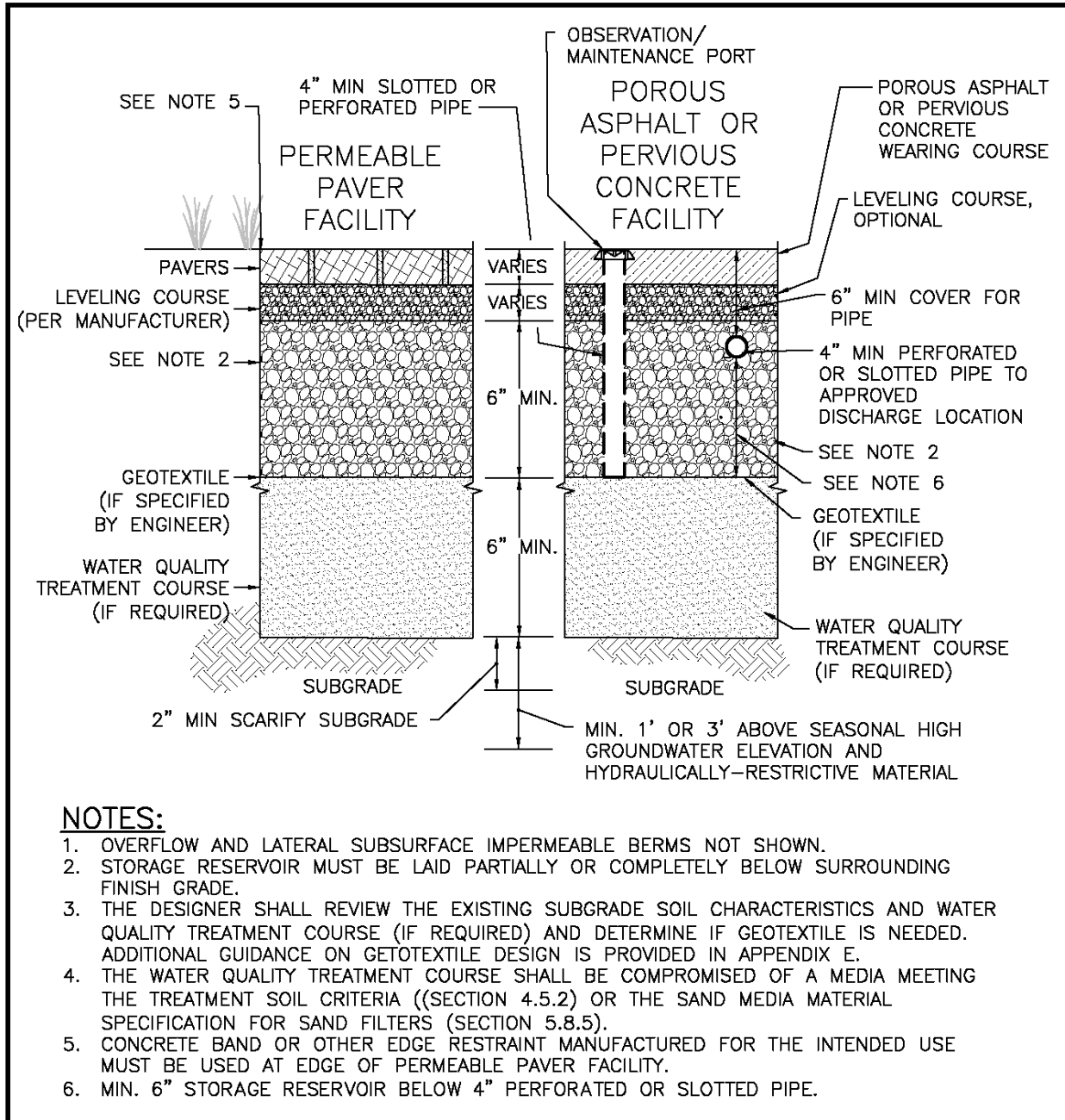

Figure 5.175-15. Permeable Pavement Facility.

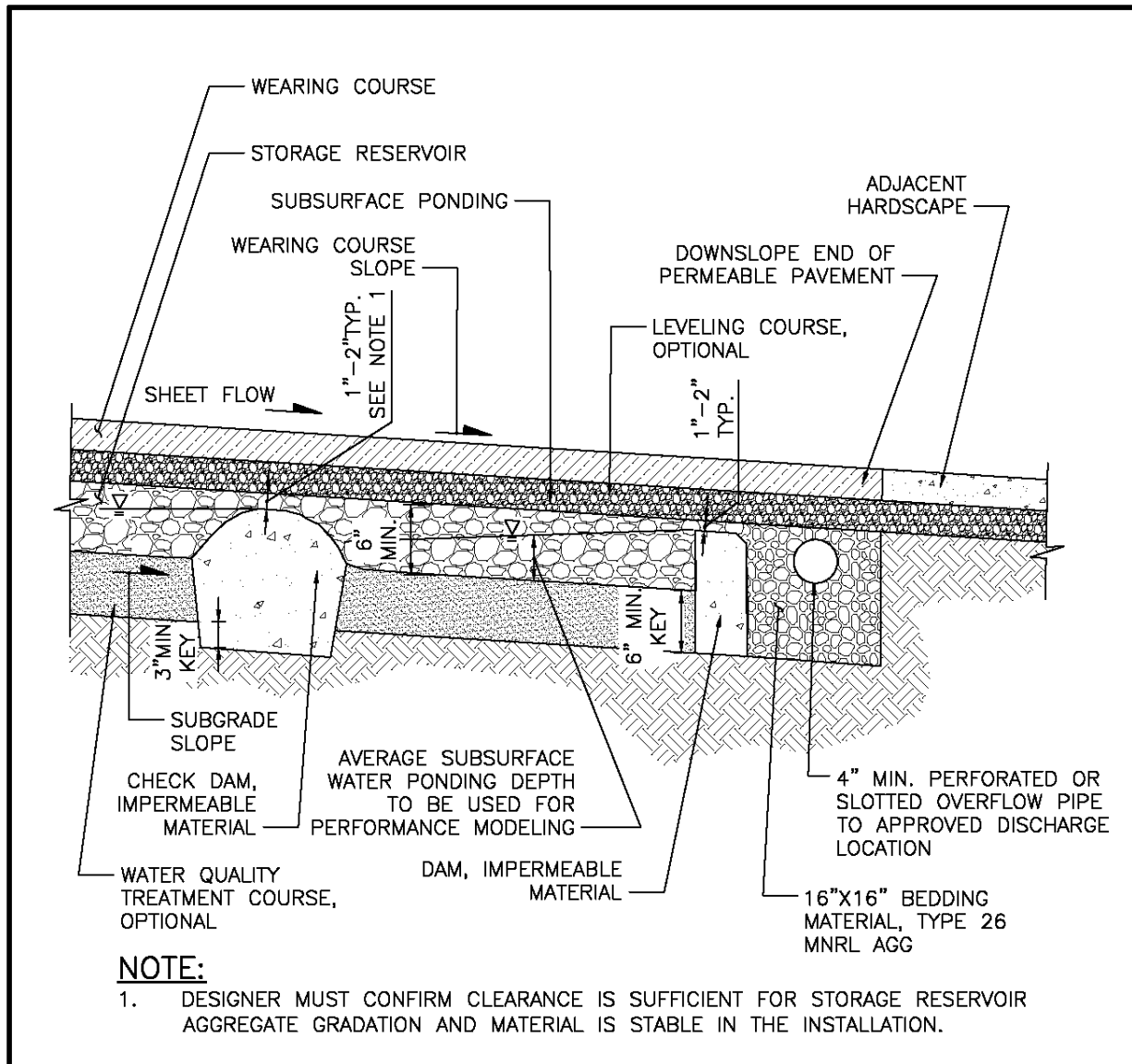

Figure 5.185-16. **Typical-Example** Permeable Pavement Facility with Checkdams.

Contributing Area

Permeable pavement facilities may be designed to manage (meet stormwater requirements for) runoff from other contributing areas (run-on). When designed to receive run-on, permeable pavement areas shall be protected from sedimentation which can cause clogging and diminished facility performance. The minimum requirements associated with the contributing area include the following:

- The contributing area shall be no larger than specified by surface type below:
 - Pollution-generating hard surfaces (e.g., roadways, parking lots): maximum run-on ratio of 2:1

- Non-pollution generating hard surfaces (e.g., roofs, sidewalks) and stabilized pervious surfaces: maximum run-on ratio of 5:1
- For a mix of surface areas, the maximum run-on ratio shall be area-weighted (e.g., a contributing area composed of half parking lot and half roof would be subject to a maximum run-on ratio of 3.5:1)
- To prevent sediment flowing onto the pavement, run-on shall not occur from erodible/unstabilized areas or from impervious areas that receive run-on from unstabilized areas.
- Run-on shall not occur from contributing areas from which sediment or pollutant loads are unavoidable. Refer to land use restrictions listed in the *Site Considerations* subsection.

Flow Entrance/Presettling

Run-on should be directed to the permeable pavement facility in a distributed manner (e.g., sheet flow) rather than through concentrated flow, where possible. Specific requirements associated with the run-on flow entrance area provided below.

- If the run-on flow is concentrated and the contributing area exceeds 1,000 square feet, run-on shall be dispersed to permeable pavement. Acceptable methods include sheet flow (e.g., dispersion trench) or subsurface delivery to the storage reservoir. ~~If subsurface delivery is used, stormwater inflows shall be routed through a catch basin or yard drain with downturned elbow (trap). Presettling requirements are provided in Section 4.4.5. After presettling, flows shall be distributed to the storage reservoir (e.g., via slotted drain pipe).~~
- If the run-on flow is concentrated and the contributing area is 1,000 square feet or less, concentrated run-on is permitted. However, the designer shall consider the concentrated flow velocity, permeable pavement slope and permeable pavement flow path to ensure that the run-on will be captured by the pavement.
- If subsurface delivery is used, stormwater inflows shall be routed through a catch basin ~~or yard drain~~ with downturned elbow (trap). Presettling requirements are provided in Section 4.4.5. After presettling, flows shall be distributed to the storage reservoir ~~(e.g., via slotted drain pipe)~~ that runs the length of the permeable pavement facility. For permeable pavement facilities wider than 40 feet, the slotted distribution pipes shall be located at a minimum of 20 feet on-center.
- Where run-on flows onto permeable pavement and flow is concentrated, these areas shall be identified in the O&M plan as requiring more frequent cleaning and inspection to ensure overall facility performance.
- If run-on flow from an impervious surface is dispersed (e.g., via sheet flow), the flow path length on the contributing impervious surface shall not be more than 5 times the flow path length on the permeable pavement. The minimum flow path length on the permeable pavement shall be 4 feet.

Wearing Course

The surface layer of a permeable pavement facility is the wearing course. Categories of wearing courses include:

- **Porous Asphalt:** Porous asphalt concrete is open-graded asphalt with reduced fines and air pockets encased within it that allow water to drain to the base below. Similar to conventional asphalt, porous asphalt is laid with traditional asphalt paving equipment. Simple applications include a single wearing course.
- **Pervious Concrete:** Pervious cement concrete is similar to porous asphalt in that the mixture omits or substantially reduces the fines to create stable air pockets encased within it. Pervious concrete typically has a rougher surface than impermeable concrete or porous asphalt.
- **Permeable Pavers:** Permeable pavers consist of paver blocks made of permeable material or paver blocks with gaps between them that allow water to drain to the base below. The most common form of permeable pavers are permeable interlocking concrete paver blocks. These are modular blocks with gaps between them that are filled with a permeable material (typically small clean stone).
- **Grid Systems:** Open-celled paving grids consist of a rigid grid composed of concrete or a durable plastic that is filled with gravel or vegetation. The support base and the ring walls prevent soil compaction and reduce rutting and erosion by supporting the weight of traffic and concentrated loads. Vegetated grid systems are filled with a mix of sand, gravel, and topsoil and planted with a variety of non-turf forming grasses or low-growing groundcovers. Gravel-filled grid systems are filled with a clean aggregate mix specified by the manufacturer. [The fill material shall be at least a minimum of 2 inches deep.](#)
- **Gravel walkways or areas:** [Gravel walkways or areas that are not subject to vehicular load and consist of one of the following materials:](#)
 - [City of Seattle Mineral Aggregate Type 22 or 24](#)
 - [Modified AASHTO Grading #57 per Washington State Department of Transportation Standard Specification for Road, Bridge and Municipal Construction, 2020 \(WSDOT 2020\) Section 9-03.1\(4\)C, with 0 to 2 percent passing #200 wet sieve; percent fracture shall be in accordance with requirements per WSDOT 2020 9-03.9\(2\)](#)

Minimum requirements associated with the wearing course design include the following:

- A minimum wearing course surface slope of 1 percent is required (2 percent recommended) to ensure positive surface drainage should the surface become clogged. Wearing course surface slopes less than 1 percent may be approved when the engineered drainage plan documents no harm from surface ponding.
- For sidewalks in the right-of-way, the wearing course surface slope shall be no more than 6 percent.
- For pervious concrete applications in the right-of-way, the pervious concrete area shall be no less than 250 square feet.
- [Wearing course material for pavers and grid systems shall be on the Allowable Permeable Pavement Wearing Course Materials for Stormwater Credit list on the SDCI website \(\[www.seattle.gov/sdci/codes/codes-we-enforce-\\(a-z\\)/stormwater-\]\(http://www.seattle.gov/sdci/codes/codes-we-enforce-\(a-z\)/stormwater-\)](#)

www.seattle.gov/dpd/codesrules/codes/stormwater) or approved [an approved equal](#) by the Director.

- [Cast-in-place pavers or pre-cast paver stones may be used as a wearing course on private property if each paver is surrounded with an area of free-draining aggregate that is at least 10 percent of the area of the paver and the required storage reservoir below the paver is maintained. The free-draining aggregate surrounding each paver shall meet the requirements of the storage reservoir or the leveling course aggregates. Note: since these pavers may be prone to movement under loads \(e.g., vehicles or heavy pedestrian traffic\), they may not be suitable for certain applications. The minimum required spacing between pavers is estimated by multiplying the required area by 2 and dividing by the perimeter of the paver per the following equation:](#)
 - [Spacing \(between pavers\) = 2 X Paver Area \(square inches\) X \(10-percent/100\) / Perimeter Length of Paver \(inches\)](#)
- For pervious concrete, City of Seattle Standard Specifications shall be used for projects in the right-of-way. For projects outside of the right-of-way, the City of Seattle Standard Specifications or an approved equivalent shall be used.
- For porous asphalt, refer to the Puget Sound LID Manual for additional guidance on wearing course design.
- [Acceptance Testing:](#)
 - For projects with less than 5,000 square feet of new plus replaced hard surface, infiltration capacity may be demonstrated using a bucket test wherein a bucket of water is thrown on the surface. If anything other than a scant amount of water puddles or runs off the surface, ~~quantitative~~ testing is required as described below.
 - For projects with 5,000 square feet or more new plus replaced hard surface a minimum initial uncorrected infiltration rate of 100 inches per hour is required, unless otherwise approved for vegetated grid systems. To improve the probability of long-term performance, significantly higher measured infiltration rates are desirable.
 - For measuring initial surface infiltration rates for porous asphalt or pervious concrete, the Standard Test Method for Infiltration Rate of In Place Pervious Concrete (ASTM C1701) or the infiltration rate field test from the City of Seattle standard specification for pervious concrete shall be used.
 - For measuring initial surface infiltration rates for permeable pavers, the Standard Test Method for Surface Infiltration Rate of Permeable Unit Pavement Systems (ASTM C1781) shall be used.
 - For grid systems, refer to manufacturers testing recommendations.

Leveling Course

Depending upon the type of wearing course, a leveling course (also called a bedding or choker course) may be required. A leveling course is often required for grid systems, permeable pavers, and pervious concrete. This course is a layer of aggregate that provides a more uniform surface for laying pavement or pavers and typically consists of crushed aggregate

smaller in size than the underlying storage reservoir. Course thickness will vary with permeable pavement type.

Leveling course material and thickness shall be included as required per manufacturer or designer recommendations. Leveling course material shall be compatible with underlying storage reservoir material (with low potential to migrate into underlying storage reservoir) and shall not limit the infiltration rate through the system.

Storage Reservoir

Stormwater passes through the wearing and leveling courses to an underlying aggregate storage reservoir, also referred to as base material, where it is filtered and stored prior to infiltration into the underlying soil. This aggregate also serves as the pavement's support base and shall be sufficiently thick to support the expected loads. Design of the subgrade for loading is outside of the scope of this manual. A licensed engineer is needed to determine subsoil load bearing, minimum aggregate base thickness, and aggregate compaction for loading.

Minimum requirements associated with the storage reservoir design include the following:

- A 6-inch minimum depth of storage reservoir aggregate is required. Note that more depth may be needed for structural design support. A shallower depth may be approved around trees where necessary to protect roots.
- The storage reservoir shall be laid partially or completely below the elevation of the surrounding grade.
- The storage reservoir shall have a minimum total void volume of 25 percent after compacted in place. Percent voids (porosity) shall be determined in accordance with ASTM C29/C29M. Use the jigging procedure to densify the sample (do not use the shoveling procedure). These requirements are met if the aggregate materials recommended below are used.
- Aggregate material shall have 0 to 2 percent passing #200 wet sieve.
- For walkways, the following aggregate materials are recommended and meet the requirements listed above:
 - City of Seattle Mineral Aggregate Type 22 or 24
 - Modified AASHTO #57 per *Washington State Department of Transportation Standard Specifications for Road, Bridge, and Municipal Construction*, ~~2020~~2014 (WSDOT ~~2020~~2014) Section 9-03.1(4)C, with 0-2 percent passing #200 wet sieve; percent fracture shall be in accordance with requirements per WSDOT ~~2014~~2020 9-03.9(2)
- For vehicular applications, the following aggregate materials are recommended and meet the requirements listed above:
 - City of Seattle Mineral Aggregate Type 13
 - Modified AASHTO #57 per WSDOT ~~2014~~2020 Section 9-03.1(4)C with 0 to 2 percent passing #200 wet sieve; percent fracture shall be in accordance with requirements per WSDOT ~~2014~~2020 9-03.9(2)

- Permeable ballast per WSDOT [2014-2020](#) Section 9-03.9(2)

Subgrade

The minimum measured subgrade infiltration rate for permeable pavement facilities without underdrains is 0.3 inch per hour. If permeable pavement facilities are to be used to meet the water quality treatment requirement, underlying soil shall meet the treatment soil requirements outlined in *Section 4.5.2* or a water quality treatment course shall be included.

During construction the subgrade soil surface can become smeared and sealed by excavation equipment. The design shall require scarification or raking of the side walls and bottom of the facility excavation to a minimum depth of 4 inches after excavation to restore infiltration rate.

Subsurface Check Dam

Sloped facilities have an increased potential for lateral flows through the storage reservoir aggregate along the top of relatively impermeable subgrade soil. This poses a risk of subsurface erosion (which may undermine pavement) and reduces the storage and infiltration capacity of the pavement facility. If required depending upon slope, the subgrade shall be designed to create subsurface ponding to detain subsurface flow, increase infiltration, and reduce structural problems associated with subgrade erosion (refer to Figure [5.185-16](#)). In such cases, ponding shall be provided using periodic lateral subsurface barriers (e.g., check dams) oriented perpendicular to the subgrade slope. While the frequency of the check dams is calculated based on the required subsurface ponding depth and the subgrade slope, typical designs include barriers every 6 to 12 inches of grade loss.

Subsurface check dams are required unless:

- The subgrade slope is less than 1 percent and the storage reservoir aggregate is laid below surrounding subgrade or
- A licensed professional makes a determination based on soil type and permeability that check dams are not required to address subgrade erosion or ensure performance of system.

Minimum requirements associated with check dams include the following:

- Check dams shall ~~be impermeable and~~ restrict lateral flow along the top of the subgrade soil. [Examples of material to use for subsurface check dams include concrete, controlled-density fill \(CDF\), or similar material.](#)
- Check dams shall be installed at regular intervals perpendicular to the subgrade slope to provide the required average subsurface ponding depth in the storage reservoir.
- The check dams shall not extend to the elevation of the surrounding ground.
- Each check dam shall have an overflow, as described below, or allow overtopping to the next downslope storage reservoir section without causing water to flow out of the pavement surface or out the sides of the base materials that are above grade.

Note that the subgrade on sloped sites may be terraced to reduce the frequency of check dams. Even with terracing, a minimum of one downstream check dam is required to provide subsurface ponding.

Overflow

Unless designed to provide full infiltration (*Section 4.5.1*), permeable pavement facilities shall have an overflow (*Section 4.3.3*). Minimum requirements associated with the overflow design include the following:

- Overflow shall be designed to convey any flow exceeding the capacity of the facility unless designed to fully infiltrate all flows for the full, required simulation period. Plans shall indicate surface flow paths in case of failure of the BMP (refer to *Section 4.3.3*). per *Section 4.3.4*. Options include:
 - Subsurface slotted drain pipe(s) set at the design ponding elevation to route flow to a conveyance system
 - Lateral flow through the storage reservoir to a daylighted conveyance system
- In the right-of-way, slotted pipe per City of Seattle Standard Plan No. 291 shall be used. On private property, perforated pipe shall meet Side Sewer Directors' Rule requirements.
- For facilities installed on a sloped subgrade, at least one overflow shall be sited at the downslope extent of the facility.
- If a slotted overflow pipe is used to collect water in the pavement section, the pipe diameter and spacing shall be designed based on the hydraulic capacity required. A non-perforated cleanout (sized to match underdrain diameter) shall be connected to the underdrain every 100 feet at a minimum. Projects in the right-of-way shall use City of Seattle Standard Plan No. 281. Projects on private properties shall use requirements in the Side Sewer Directors' Rule.
- A minimum wearing course surface slope of 1 percent is required (2 percent recommended) to ensure positive surface drainage should the surface become clogged.
- The designer shall consider the flow path of water when the permeable pavement section is fully saturated to the maximum design depth or when the wearing course is clogged to confirm there are no unanticipated discharge locations (e.g., impact to intersecting utility trenches, sheet flow to adjacent properties). The flow path shall be described on the plan submittal.
- If a permeable pavement facility is used in the public roadway section, the roadway conveyance system shall be designed as if the road surface were impermeable unless otherwise approved by the Director.

Note that the slotted pipe discussed in this section is set at the design ponding depth in the storage reservoir and is considered an overflow, not an underdrain. Underdrains are addressed in a separate subsection below.

Geotextile

Generally, geotextiles and geogrids are used for the following purposes:

- As a filter layer to prevent clogging of infiltration surfaces
- To prevent fines from migrating to more open-graded material and causing associated structural instability
- To prevent downward movement of the aggregate base into the subgrade for soil types with poor structural stability

Geotextiles between the permeable pavement subgrade and aggregate base [in a traditional permeable pavement facility design](#) are not required or necessary for many soil types and, if incorrectly applied, can clog and reduce infiltration capability at the subgrade or other material interface. Therefore, the use of geotextiles is discouraged unless it is deemed necessary. As part of the pavement section design, the designer shall review the existing subgrade soil characteristics and treatment layer if any, and determine if geotextile is needed. [If a combination permeable pavement facility and infiltration chamber facility is being used, geotextile shall be placed between the wearing course and the stackable, modular plastic cells.](#) Additional guidance on geotextile design is provided in *Appendix E*.

Minimum requirements associated with the geotextile design, if used, include the following:

- Use geotextile recommended by the manufacturer's specifications and by a geotechnical engineer for the given subgrade soil type or treatment layer and base aggregate.
- Extend the fabric up the sides of the excavation. This is especially important if the base is adjacent to conventional paving surfaces to prevent migration of fines from dense-graded base material and soil subgrade to the open graded base. Geotextile is not required on the sides if concrete curbs extend the full depth of the base/sub-base.
- Overlap adjacent strips of fabric at least 24 inches.
- Use geotextile that passes water at a greater rate than the design infiltration rate for the existing subgrade soils.

Water Quality Treatment Course (If Required)

If the permeable pavement is being designed to provide water quality treatment or if the permeable pavement will be PGHS exceeding 2,000 square feet, underlying soils shall meet the requirements for treatment soil provided in *Section 4.5.2*. If the existing subgrade does not meet these requirements, a 6-inch water quality treatment course shall be included between the subbase and the storage reservoir. The course shall be composed of a media meeting the treatment soil criteria (*Section 4.5.2*) or the sand media material specification for sand filters in *Section 5.8.5*.

Observation/Maintenance Port

If a permeable pavement facility is designed to meet flow control and/or water quality treatment requirements and the permeable pavement area plus the run-on area (if any) is 5,000 square feet or greater, it shall be equipped with an observation/maintenance port to allow for monitoring of the drawdown time following a storm. The observation/maintenance port shall consist of an ~~8-inch~~ 4-inch minimum diameter perforated or slotted pipe with a ~~locking lid~~ secure well cap that extends to the bottom of the pavement section and keyed into the subbase. ~~The port shall be located at the downslope area of the pavement system. Additional ports are required for every additional 5,000 square feet of permeable pavement area plus run-on area.~~

Observation/maintenance ports are required:

- At the downslope area of the pavement system and
- One for every additional 5,000 square feet of contributing area (permeable pavement area plus run-on area)

Underdrain (Optional)

Underdrain systems shall be installed if the subgrade soils have a measured infiltration rate of less than 0.3 inch per hour. Designs utilizing underdrains provide less infiltration and flow control benefits. To improve performance, the underdrain may be elevated to maximize infiltration and/or outlet controls (e.g., orifice control) may be used to attenuate underdrain flows prior to release.

The underdrain pipe diameter will depend on hydraulic capacity required. The minimum requirements associated with the underdrain design include:

- In the right-of-way, slotted pipe per City of Seattle Standard Plan No. 291 shall be used. On private property, perforated pipe shall meet Side Sewer Directors' Rule requirements.
- Underdrain pipe slope shall be no less than 0.5 percent.
- ~~Aggregate around pipe shall be graded to filter sediment and prevent clogging.~~
- A non-perforated cleanout (sized to match underdrain diameter) shall be connected to the underdrain every 100 feet minimum. Projects in the right-of-way shall use City of Seattle Standard Plan No. 281. Projects on private properties shall use requirements in the Side Sewer Directors' Rule.

Note that the slotted pipe discussed in this section is set below the design ponding depth in the storage reservoir and is considered an underdrain, not an overflow. Overflows are addressed in a separate subsection above.

Edge Treatment

Edge treatment is required around the perimeter of permeable pavers to prevent it from unraveling over time. Edge treatments can also be used to protect the subgrade of adjacent conventional pavement. Refer to Figures 5.19 and 5.20 for examples of concrete and geomembrane edge treatments, respectively. Concrete edge treatments may be used for either of those purposes while geomembrane may only be used to protect adjacent pavement. A manufactured paver restraint may also be used at edges, but it shall be suitable for the pavement use (e.g., vehicular use vs. pedestrian only).

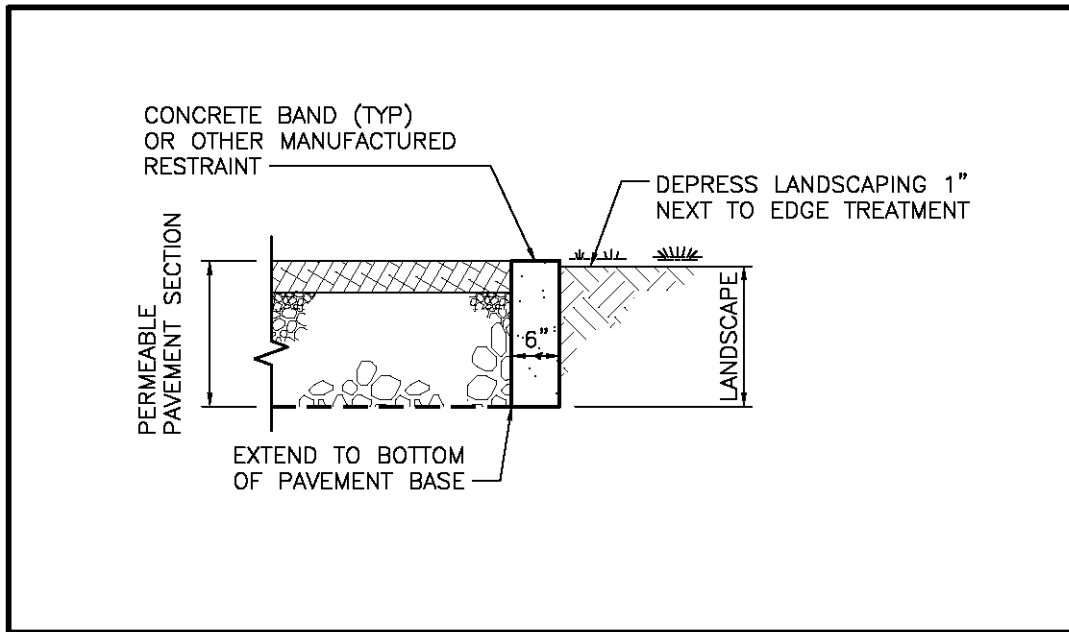
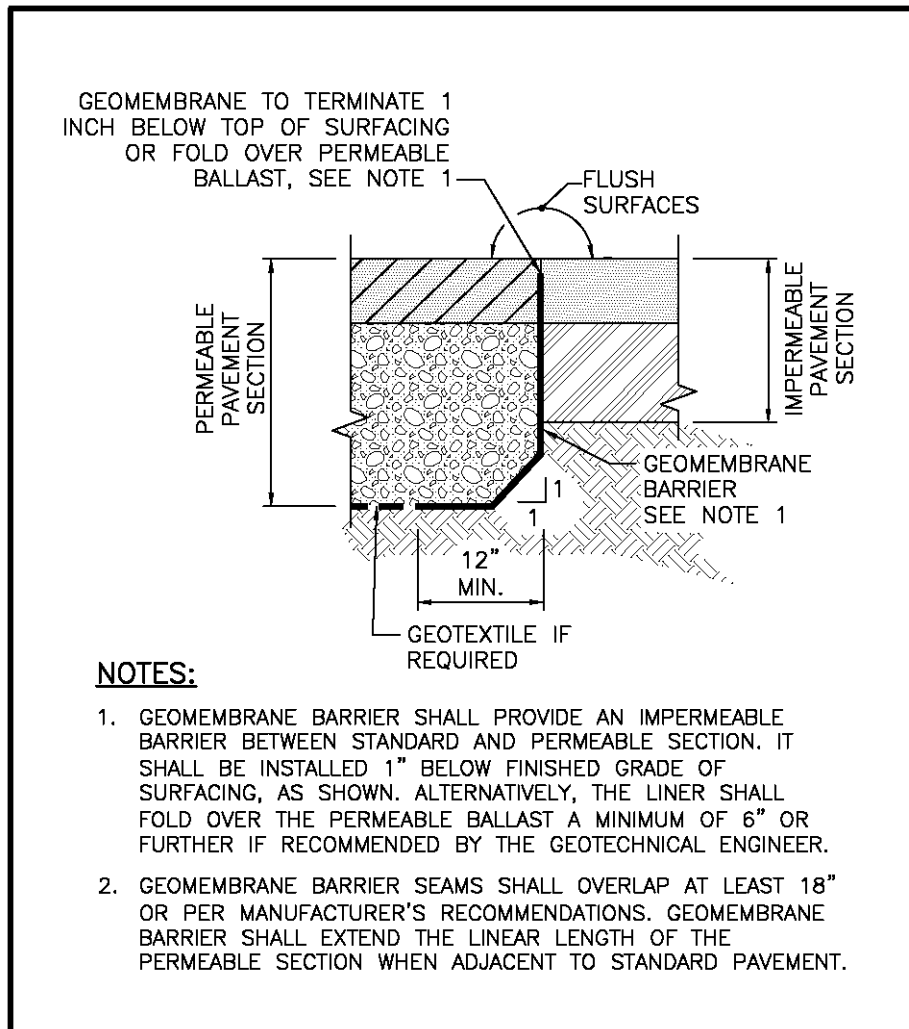

Figure 5.19. Example Permeable Pavement Concrete Edge Treatment.



[Figure 5.20. Example Permeable Pavement Geomembrane Edge Treatment.](#)

5.4.6.6. BMP Sizing

Sizing for On-site List Approach

Permeable pavement facilities without underdrains may be selected to meet the On-site List Requirement (refer to *Section 3.3.1* and *Appendix C* for infeasibility criteria). The area of the permeable pavement facility meets the requirement. In addition, hard surface area contributing run-on to a permeable pavement facility also meets the requirement if it does not exceed the thresholds listed below:

- For pollution-generating hard surfaces (e.g., roadways, parking lots) the run-on ratio shall be no more than 2:1 (sizing factor 50 percent or greater)
- For non-pollution generating hard surfaces (e.g., roofs, sidewalks) and stabilized pervious surfaces the run-on ratio shall be no more than 5:1 (sizing factor 20 percent or greater)

- For a mix of surface areas, the maximum run-on ratio shall be area-weighted (e.g., a contributing area composed of half parking lot and half roof would be subject to a maximum run-on ratio of 3.5:1).

For permeable pavement facilities receiving run-on, the minimum required permeable pavement facility area is calculated as 50 and 20 percent of the hard surface area routed to it for pollution-generating and non-pollution generating hard surfaces, respectively.

Pre-sized Approach for Flow Control and Water Quality Treatment

The Pre-sized Approach may be used for projects with new and replaced hard surface areas up to 10,000 square feet. Under the Pre-sized Approach (refer to *Section 4.1.2*), pre-sized permeable pavement facilities without underdrains may be used to achieve Pre-developed Pasture, Peak Control and Water Quality Treatment Standards. Sizing factors and equations for permeable pavement facilities receiving runoff from a hard surface are provided in [Table 5-245.26](#). Factors are organized by performance standard, subgrade soil design infiltration rate, and contributing area. The design rate for the subgrade soil shall be rounded down to the nearest infiltration rate in the pre-sized table (i.e., 0.15, 0.3, 0.6, 1.0, or 2.5 inches per hour).

To use these sizing factors or equations to meet performance standards, the facility shall meet the general requirements for permeable pavement facilities outlined in this section plus the following specific requirements:

- The permeable pavement area shall be sized using the applicable sizing factor or equation.
- The selected subsurface ponding depth (i.e., 6 or 12 inches) shall be provided in the storage reservoir. For intermediate ponding depths (between 6 and 12 inches), the sizing factor may be linearly interpolated. For subgrade slopes of 1.0 percent or greater, check dams are required to provide this subsurface ponding depth, on average, across the facility.
- To meet water quality treatment, the underlying soil shall meet the soil requirements outlined in *Section 4.5.2* or a water quality treatment course shall be used.
- No underdrain or [low-permeability liner or](#) impermeable liner may be used.

Table 5.245.26. Pre-sized Sizing Factors and Equations for Permeable Pavement Facilities without Underdrains.

Ponding Depth in Storage Reservoir	Subgrade Soil Design Infiltration Rate	Contributing Area (sf)	Sizing Factor/Equation for Permeable Pavement Facility Area ^a			
			Pre-developed Pasture Standard	Peak Control Standard	Water Quality Treatment Standard ^b	
6 inches	0.15 inch/hour	≤ 2,000	132.6%	256.8342.1%	26.9%	
		2,001 – 10,000	[0.4842 x A] + 1651.1			
	0.3 inch/hour	≤ 2,000	99.8%	490.2247.4%	24.6%	
		2,001 – 10,000	[0.375 x A] + 1223.9			
	0.6 inch/hour	≤ 2,000	34.1%	56.958.0%	20.0% ^c	
		2,001 – 10,000	[0.1568 x A] + 369.4			
	1.0 inch/hour	≤ 2,000	29.2%	49.650.6%	20.0% ^c	
		2,001 – 10,000	[0.1349 x A] + 314.9			
	2.5 inch/hour	≤ 2,000	20.0% ^c	22.422.7%	20.0% ^c	
		2,001 – 10,000	[0.053 x A] + 110.7			
	12 inches	0.15 inch/hour	≤ 2,000	71.4%	400.8113.9%	20.0% ^c
			2,001 – 10,000	[0.3236 x A] + 785.9		
0.3 inch/hour		≤ 2,000	55.5%	79.388.1%	20.0% ^c	
		2,001 – 10,000	[0.2573 x A] + 600.3			
0.6 inch/hour		≤ 2,000	23.8%	36.436.6%	20.0% ^c	
		2,001 – 10,000	[0.1247 x A] + 229.2			
1.0 inch/hour		≤ 2,000	20.5%	32.733.1%	20.0% ^c	
		2,001 – 10,000	[0.1076 x A] + 198.2			
2.5 inch/hour		≤ 2,000	20.0% ^c	20.0% ^c	20.0% ^c	
		2,001 – 10,000	[0.0435 x A] + 81.7			

A – contributing hard surface area; sf – square feet.

For Sizing Factors: Permeable Pavement Facility Area = Contributing Hard Surface Area x Factor (%) / 100.

Hard Surface Area Managed = Permeable Pavement Area ÷ Factor (%) / 100.

For Sizing Equations: Permeable Pavement Area (sf) = [Factor x A (sf)] + Integer.

Hard Surface Area Managed (sf) = [Permeable Pavement Area (sf) – Integer] ÷ Factor.

^a Maximum run-on ratios apply which may require larger permeable pavement facilities than those sized using the Pre-sized Approach.

^b Pre-sized Approach may be used to meet basic water quality treatment. Enhanced water quality treatment may be achieved if soil suitability criteria are met (refer to Section 4.5.2).

^c The minimum sizing factor is 20 percent because the contributing area to a facility is limited to 5 times the permeable pavement facility area.

The required permeable pavement facility area is calculated as a function of the hard surface area routed to it. As an example, to meet the Pre-developed Pasture Standard using a permeable pavement facility with an average water depth in the storage reservoir of 6 inches for a contributing area less than 2,000 square feet, the permeable pavement area would be equal to 34.1 percent of the hard surface area routed to it when the subgrade infiltration rate is between 0.6 and 0.99 inch per hour (Table 5.24). If the contributing area is a non-pollution generating surface (e.g., roof, sidewalk), a sizing factor of 34.1 percent is acceptable because it is greater than 20 percent (corresponding to a run-on ratio less than 5:1).

However, if the contributing area is pollution generating (e.g., driveway, parking lot), a minimum sizing factor of 50 percent is required (corresponding to a run-on ratio less than 2:1). If the contributing area is a mix of surface types, the minimum sizing factor and maximum run-on ratio must-shall be calculated as a weighted average:

$$\text{Minimum Sizing Factor} = (\% \text{ area non-pollution generating} \times 20\% + \% \text{ area pollution generating} \times 50\%) / 100\%$$

$$\text{Maximum Run-on Ratio (X:1)} = (\% \text{ area non-pollution generating} \times 5 + \% \text{ area pollution generating} \times 2) / 100\%$$

For example, a site with 70 percent roof and 30 percent driveway would have a minimum sizing factor of 29 percent $[(70\% \times 20\% + 30\% \times 50\% / 100)]$ and a maximum run-on ratio of 4:1 $[(70\% \times 5 + 30\% \times 2) / 100\%]$.

Alternatively, permeable pavement facilities can be sized using a continuous simulation hydrologic model as described below.

Modeling Approach for On-site Performance Standard, Flow Control, and Water Quality Treatment

When using continuous simulation hydrologic modeling to size permeable pavement, the assumptions listed in Table [5-255.27](#) shall be applied. It is recommended that permeable pavement be modeled as an impervious area with runoff routed to a gravel-filled infiltration trench (with the same area as the contributing impervious area). Runoff from other areas draining to the permeable pavement surface can also be routed to the trench. The contributing area, pavement area, and average subsurface ponding depth in the aggregate storage reservoir should be iteratively sized until the Minimum Requirements for On-site Stormwater Management, Flow Control and/or Treatment are met (refer to *Volume 1 – Project Minimum Requirements*) or where it has been determined by the Director that there is no off-site point of discharge for the project, the requirements of Section 4.3.2 are met. General sizing procedures for infiltration facilities are presented in *Section 4.5.1*. Specific modeling guidelines are outlined below:

- Model only the average depth of the storage reservoir occupied by ponded water before check dam overtopping or overflow. The storage reservoir aggregate above this depth, and the overlying leveling and wearing course are not modeled.
- Because the infiltration rates of the wearing course and leveling course are typically high and will not restrict flow entering the facility section, the infiltration through these layers may be neglected (i.e., not modeled).
- The area of subgrade covered by check dams must-shall be excluded from gravel trench bottom area.
- Only the volume in the reservoir course may be used as storage volume in the model. The BMP shall not rely on void space in the wearing course to function.

Table 5.255.27. Continuous Modeling Assumptions for Permeable Pavement Facility.

Variable	Assumption
Precipitation Series	Seattle 158-year, 5-minute series
Computational Time Step	5 minutes
HSPF Parameters	LSUR, SLSUR, NSUR shall be adjusted per Appendix F
Permeable Pavement Facility and Contributing Area	Option 1: WWHM and MGSFlood have a modeling element The selected model may have a routine specifically developed for permeable pavement that simulates run-on from other contributing drainage areas, precipitation falling on the pavement, infiltration through the pavement section, storage in the aggregate beneath the pavement, and infiltration into the underlying soil. Option 2: If a permeable pavement modeling element routine is not available in the selected model , represent the permeable pavement area as an impervious basin with runoff routed to a gravel-filled trench (of the same size as the permeable pavement area) with infiltration to underlying soil. Other drainage areas contributing runoff to the pavement (surface flow and interflow), if any, are also routed to the gravel trench.
Precipitation Applied to Facility	If using Option 1, precipitation is applied to the pavement area. If using Option 2, do not apply precipitation to the trench bed because precipitation is already applied to basin before routing to trench.
Evaporation Applied to Facility	If using Option 1, evaporation is applied to the pavement area. If using Option 2, while evaporation is applied to the impervious basin before routing to the trench.
Storage Reservoir Depth	Average subsurface water ponding depth in the pavement aggregate courses (average across the facility) before check dam overtopping or overflow.
Storage Reservoir Porosity	Assume maximum 25 percent unless test is provided showing higher porosity (up to 35 percent) for aggregate compacted and in place.
Subgrade Soil Design Infiltration Rate	Design infiltration rate (<i>Section 4.5.2, Appendix D</i>).
Infiltration Across Wetted Surface Area	No, if subgrade sidewalls are steeper than 2H:1V (infiltration on bottom area only).
Outlet Structure	Unless the selected model represents surface sheet flow when pavement section is saturated, the overflow can be simulated as overtopping an overflow riser. Overflow riser elevation is set at average maximum subsurface ponding depth. Flow may be modeled as weir flow over riser edge. Freeboard modeled within the storage reservoir shall be sufficient to allow the water surface elevation to rise above the weir or overflow pipe elevation to provide head for discharge.

5.4.6.7. Minimum Construction Requirements

Proper construction methods and pre-planning are essential for the successful application of any permeable paving facility. Over compaction of the underlying soil or fine sediment contamination onto the existing subgrade and pavement section during construction will significantly degrade or effectively eliminate the infiltration capability of the facility.

Minimum requirements associated with construction of a permeable pavement facility include the following:

- Conduct field infiltration and compaction testing of the water quality treatment course (if included) prior to placement of overlying courses.

- Prevent intermixing of the various base course materials with fines and sediment. Remove and replace all contaminated material.
- Complete final subgrade excavation during dry weather on the same day bottom aggregate course is placed, when practicable.
- Use traffic control measures to protect permeable pavement subgrade areas from heavy equipment operation or truck/vehicular traffic.
- Select excavation, grading, and compaction equipment to minimize the potential for over-compaction.
- [Follow a back-dumping approach to prevent compaction when installing the aggregate base. Back-dumping includes the following steps:](#)
 1. [The aggregate base is dumped onto the subgrade from the edge of the installation and the aggregate is then pushed out onto the subgrade.](#)
 - 5-2. [Trucks then dump subsequent loads from on top of the aggregate base as the installation progresses.](#)
- Isolate the permeable pavement site from sedimentation during construction, either by use of effective erosion and sediment control measures upstream. Alternatively, delay the excavation of the lowest 1 foot of material above the final subgrade elevation for the entire pavement area until after all sediment-producing construction activities have been completed and upstream areas have been permanently stabilized. Once the site is stabilized, the lowest 1 foot of material may be removed. For more information on site stabilization, refer to *Volume 2 – Construction Stormwater Control*.
- Conduct field infiltration test of the permeable surface after the complete pavement section is installed to verify that it meets the minimum initial uncorrected infiltration rate of 100 inches per hour (refer to testing methods in the *Wearing Course* subsection in *Section 5.4.6.5*).

5.4.6.8. Operations and Maintenance Requirements

Permeable pavement O&M requirements are provided in *Appendix G (BMP No. [2625](#))*.

5.4.7. Perforated Stub-Out Connections

5.4.7.1. Description

A perforated stub-out connection is a length of perforated pipe within a gravel-filled trench that is placed between roof downspouts and a stub-out connection to the public drainage system.

5.4.7.2. Performance Mechanisms

Perforated stub-out connections are intended to provide some flow control via infiltration during drier months. During the wet winter months, they may provide little or no flow control.

5.4.7.3. Applicability

As shown in the table below, perforated stub-out connections can only be applied to meet the on-site stormwater management requirement using the On-site List Approach.

BMP	On-site		Flow Control			Water Quality			Conveyance	
	List	Standard	Forest	Pasture	Peak	Basic	Enhanced	Oil Control		Phosphorus
Perforated Stub-out Connections	✓									

5.4.7.4. Site Considerations

The stub-out connection should be sited to allow a maximum amount of runoff to infiltrate into the ground (ideally a dry, relatively well drained, location). Site considerations for the applicability of perforated stub-out connections include:

- **Setbacks and restrictions:** The perforated portion of the system shall meet the siting and infiltration rate requirements for infiltration facilities presented in *Section 3.2 and Section 4.5*.
- **Site prohibitions:** The perforated pipe portion of the system shall not be located under hard or heavily compacted (e.g., driveways and parking areas) surfaces.
- Refer to *Appendix C* for additional infeasibility criteria for the On-site List Approach.

5.4.7.5. Design Criteria

This section provides a description and requirements for the components of perforated stub-out connections. A typical stub-out connection is shown in Figure [5.215-17](#). Design criteria are provided in this section for the following elements:

- Presettling
- Perforated pipe and trench
- Overflow

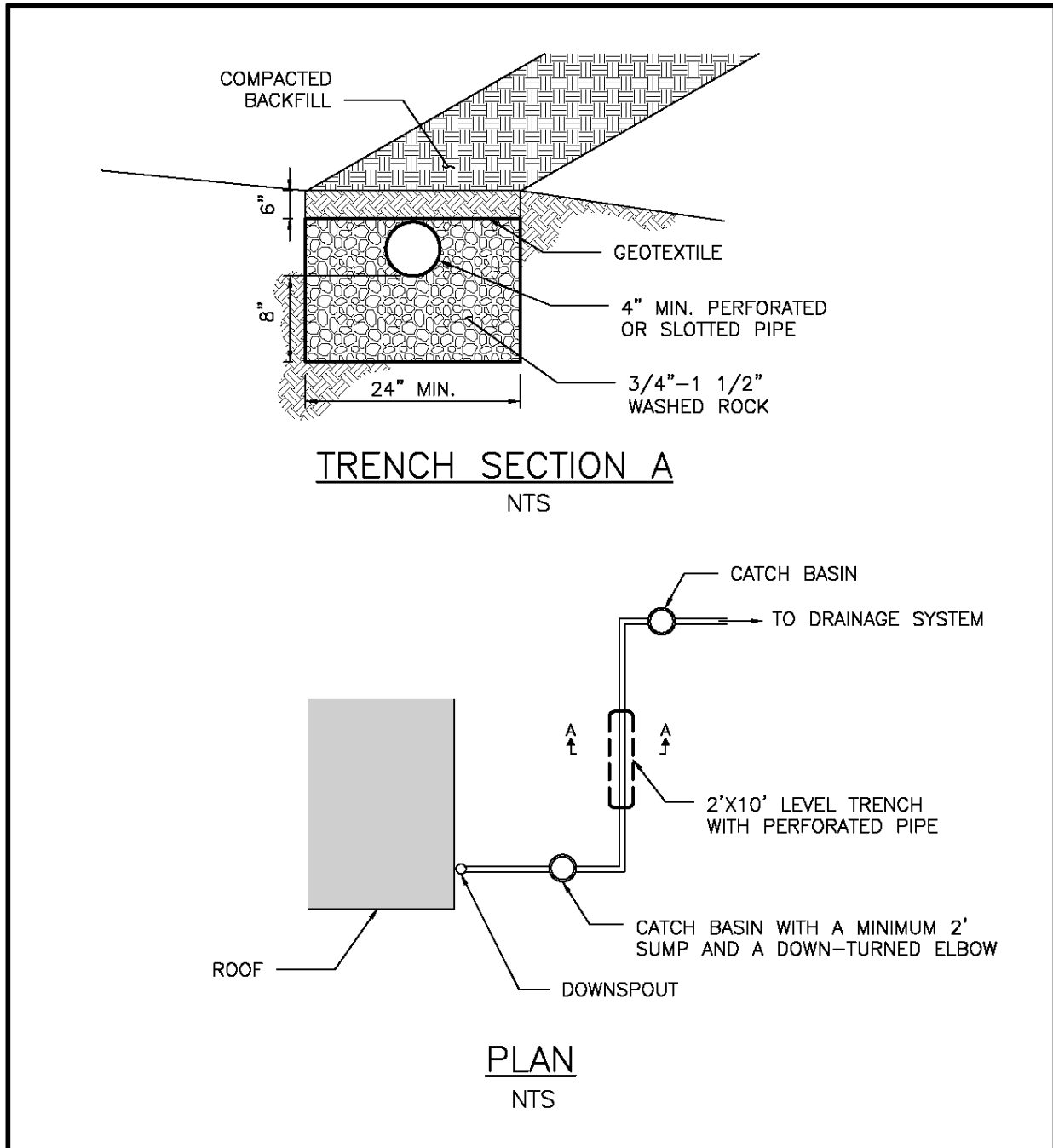

Figure 5.215-17. Perforated Stub-Out Connection.

Presettling

- Stormwater inflows shall be routed through a catch basin ~~or yard drain~~ with a downturned elbow (trap). Presettling requirements are provided in *Section 4.4.5*.

Perforated Pipe and Trench

The minimum requirements associated with the pipe and trench include the following:

- Perforated stub-out connections shall be at least 10 feet of perforated pipe per 5,000 square feet of roof area.
- The trench shall be a minimum of 2 feet wide and 18 inches deep. The bottom of the trench shall be level.
- The trench shall be filled with uniformly-graded, washed gravel with a nominal size from 0.75- to 1.5-inch diameter. The minimum void volume shall be 30 percent. These requirements can be met with City of Seattle Mineral Aggregate Type 4.
- The pipe length that extends through the trench shall be a perforated or slotted pipe with a minimum diameter of 4 inches. The pipe shall be placed level with the pipe invert a minimum of 8 inches above the bottom of the trench.
- The trench shall be wrapped with non-woven geotextile fabric, [according to specifications in Appendix E](#), and covered with 6 inches of compacted backfill.

Subgrade

The minimum measured subgrade infiltration rate for perforated stub-out connections is 0.3 inch per hour.

During construction the subgrade soil surface can become smeared and sealed by excavation equipment. The design shall require scarification or raking of the side walls and bottom of the facility excavation to a minimum depth of 4 inches after excavation to restore infiltration rate.

Overflow

Perforated stub-out connections shall have an overflow designed to convey any flow exceeding the capacity of the facility ~~per~~ [unless designed to fully infiltrate all flows for the full, required simulation period. Plans shall indicate surface flow paths in case of failure of the BMP \(refer to Section 4.3.3\)](#).

~~Section 4.3.4~~ If overflow is connected to the public drainage system, a catch basin shall be installed prior to the connection to the public drainage system to prevent root intrusion into public drainage main lines.

5.4.7.6. BMP Credits

Credit for On-site List Approach

Perforated stub-outs may be selected to meet the On-site List Requirement (refer to *Section 3.3.1* and *Appendix C* for infeasibility criteria). The area of hard surface conveyed using a perforated stub-out meets the requirement.

Pre-sized Approach

Perforated stub-out connections are not included in the Pre-sized Approach because this BMP is not eligible for flow control credits.

Modeling Approach

Any flow reduction is variable and unpredictable. No computer modeling techniques are allowed that would predict any reduction in flow rates and volumes from the connected area.

5.4.7.7. Minimum Construction Requirements

During construction, it is critical to prevent clogging and over-compaction of the subgrade. The minimum construction requirements for infiltration trenches in *Section 5.4.2.7* apply.

5.4.7.8. Operations and Maintenance Requirements

General O&M requirements for infiltration facilities apply to perforated stub-out connections. Perforated stub-out connection O&M requirements are provided in *Appendix G (BMP No. 2)*.

5.4.8. Infiltration Basins

5.4.8.1. Description

Infiltration basins are large earthen impoundments used for the collection, temporary storage, and infiltration of stormwater runoff.

5.4.8.2. Performance Mechanisms

Pollutant removal and flow control occur through infiltration of stormwater into the underlying soils. Secondary pollutant removal mechanisms include filtration, adsorption, and biological uptake.

5.4.8.3. Applicability

An infiltration basin can be designed to provide treatment and/or flow control. This BMP can be applied to meet the requirements listed below.

BMP	On-site		Flow Control			Water Quality				Conveyance
	List	Standard	Forest	Pasture	Peak	Basic	Enhanced	Oil Control	Phosphorus	
Infiltration Basin		✓	✓	✓	✓	✓ ^a	✓ ^a		✓ ^b	

^a Soil suitability criteria (Section 4.5.2) and applicable drawdown requirements (Section 4.5.1) also apply.

^b Refer to treatment train options for infiltration BMPs included in Section 4.4.3.2.

5.4.8.4. Site Considerations

Refer to Infiltration Basins in Volume [V#](#) of the SWMMWW for site considerations related to infiltration basins. Additional site considerations may apply depending on site conditions and other factors.

5.4.8.5. Design Criteria

Refer to Infiltration Basins in Volume [V#](#) of the SWMMWW for infiltration basin design criteria.

5.4.8.6. BMP Sizing

Refer to Infiltration Basins in Volume [V#](#) of the SWMMWW for infiltration basin sizing requirements.

5.4.8.7. Minimum Construction Requirements

Refer to Infiltration Basins in Volume [V#](#) of the SWMMWW for infiltration basin minimum construction requirements. The following minimum construction requirements also apply to infiltration basins installed in Seattle:

- The development plan sheets shall list the proper construction sequence so that the infiltration basin is protected during construction.
- The floor of an infiltration basin shall be raked or deep tilled after final grading to restore infiltration rates.

5.4.8.8. Operations and Maintenance Requirements

Infiltration basin O&M requirements are provided in *Appendix G (BMP No. 2)*.

5.4.9. Infiltration Chambers/Vaults

5.4.9.1. Description

Infiltration chambers/vaults are buried structures, ~~typically arch-shaped~~, within which collected stormwater is temporarily stored and then infiltrated into the underlying soil. Infiltration chambers/vaults create an underground cavity that can provide a greater void volume than infiltration trenches and often require a smaller footprint.

Infiltration chambers are subject to state UIC regulations. Provided that the design and O&M criteria in this section are met, only the registration requirement applies.

Ecology SWMMWW Language	References
<u>All UIC wells must be registered except: UIC wells at single-family homes (or duplexes) receiving only residential roof runoff used to collect stormwater runoff from roof surfaces on an individual home (or duplex) or for basement flooding control.</u>	<ul style="list-style-type: none"> <u>Volume I, Chapter 4, Section 1-4.3 of the SWMMWW (Ecology 2019)</u>

5.4.9.2. Performance Mechanisms

Infiltration chambers/vaults can be used on their own or in combination with other BMPs to provide temporary storage of stormwater runoff and subsequent infiltration into the underlying soils. Pollutant removal mechanisms include infiltration, filtration, and soil adsorption.

5.4.9.3. Applicability

Infiltration chambers/vaults can be designed to provide on-site stormwater management, flow control and/or treatment. This BMP can be applied to meet the requirements listed below.

BMP	On-site		Flow Control			Water Quality				Conveyance
	List	Standard	Forest	Pasture	Peak	Basic	Enhanced	Oil Control	Phosphorus	
Infiltration Chambers/Vaults		✓	✓	✓	✓	✓ ^a	✓ ^a		✓ ^b	

^a Soil suitability criteria for subgrade soils (Section 4.5.2) and applicable drawdown requirements (Section 5.4.1) also apply.

^b Refer to treatment train options for infiltration BMPs included in Section 4.4.3.2.

5.4.9.4. Site Considerations

Site considerations for the applicability of infiltration chambers/vaults are provided in Section 3.2 and Section 4.5.

5.4.9.5. Design Criteria

The following provides a description and requirements for the components of infiltration chambers/[vaults](#). Some or all of the components may be used for a given application depending on the site characteristics and restrictions and design objectives. Refer to Figure [5.225-18](#) for a schematic of a typical infiltration chamber/[vault](#). Design criteria are provided in this section for the following elements:

- Flow entrance and presettling
- Chamber/[vault](#) materials and layout
- Chamber/[vault](#) bedding
- [Subgrade](#)
- [Liner](#)
- [Overflow](#)
- [Observation/maintenance port](#)

Flow Entrance and Presettling

Inflow pipe or a manifold system shall be connected to each infiltration chamber/[vault](#). Stormwater inflows shall be routed through a catch basin ~~with or yard drain~~ with downturned elbow (trap). Presettling requirements are provided in *Section 4.4.5*.

Chamber/[Vault](#) Materials and Layout

Infiltration chambers/[vaults](#) can be constructed of a variety of different materials (i.e., plastic, concrete, aluminum, steel) and shapes (i.e., arch, box). Chamber/[vault](#) spacing and depth of cover shall be per the manufacturer's requirements.

Chamber/[Vault](#) Bedding

Infiltration chamber/[vault](#) bedding is specified by the manufacturer. Minimum bedding shall be from 6 inches below the infiltration chamber/[vault](#) to an elevation one-half the height of the chamber/[vault](#) on the outside of the chamber/[vault](#). Chambers/[vaults](#) shall be bedded with uniformly-graded, washed gravel with a nominal size from 0.75- to 1.5-inch diameter. The minimum void volume shall be 30 percent. These requirements can be met with City of Seattle Mineral Aggregate Type 4.

Subgrade

The minimum measured subgrade infiltration rate for infiltration chambers/[vaults](#) is 0.6 inch per hour.

During construction the subgrade soil surface can become smeared and sealed by excavation equipment. The design shall require scarification or raking of the side walls and bottom of the facility excavation to a minimum depth of 4 inches after excavation to restore infiltration rate.

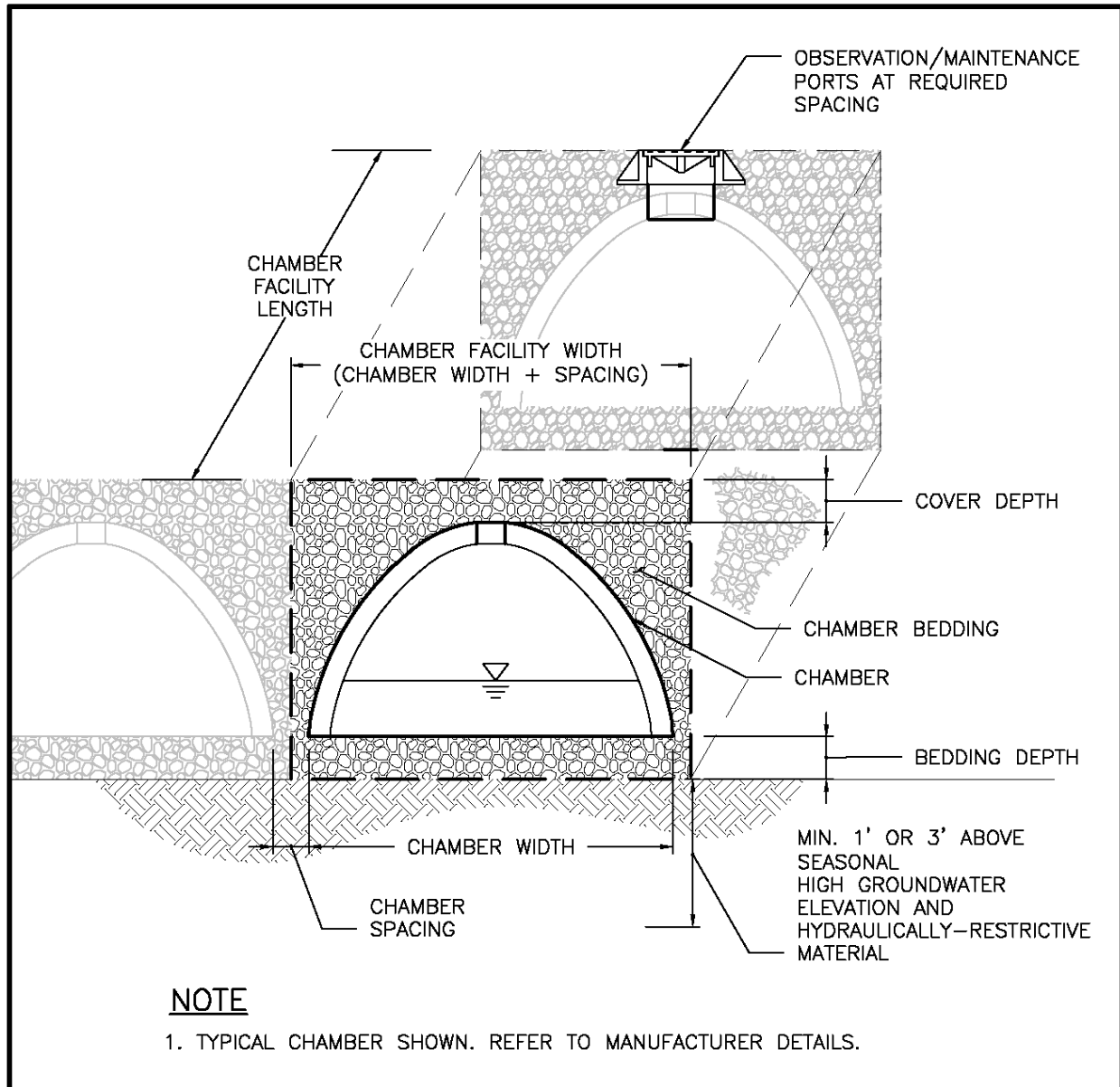

Figure 5.225-18. Typical Infiltration Chamber/Vault.

Liner

Non-woven geotextile fabric, a low permeability liner, or an impermeable liner shall be placed at the sides of a stackable, modular infiltration chamber where the chamber abuts soil or other in situ material. Refer to the specifications presented in Appendix E.

Overflow

Infiltration chambers/vaults shall have an overflow designed to convey any flow exceeding the capacity of the facility unless designed to fully infiltrate all flows for the full, required simulation period. Plans shall indicate surface flow paths in case of failure of the BMP (refer to per-Section 4.3.3). If overflow is connected to the public drainage system, a catch basin

shall be installed prior to the connection to the public drainage system to prevent root intrusion into public drainage main lines.

Observation/Maintenance Port

Infiltration chambers/vaults shall be equipped with observation/maintenance ports to measure the drawdown time following a storm, to monitor sedimentation, to determine maintenance needs, and to provide access for sediment removal. Observation/maintenance ports at a 50-foot minimum spacing are required at:

- All inlets
- All outlets
- Any sediment forebay/trap

The observation/maintenance ports shall consist of a 24-inch minimum diameter opening for maintenance access with unobstructed view down to the gravel bedding. The ports shall have locking lids. The ports for stackable, modular infiltration chamber products shall have an open, unobstructed view to the bottom of the chambers. If the port uses pipe that extends to the bottom of the chamber, it shall be perforated or slotted pipe and shall have openings at the bottom to allow for sediment removal. If 24-inch-diameter ports are not available from the manufacturer of the modular chamber product, a 12-inch-diameter port can be used for stackable, modular infiltration chambers. Refer to the Operations and Maintenance Requirements (*Section 5.4.9.8*) for personnel access requirements.

If personnel will be entering the facility, a 24-inch-diameter ring and cover and a 36-inch-diameter vertical pipe is required.

5.4.9.6. BMP Sizing

Pre-sized Approach for Flow Control and Water Quality Treatment

The Pre-sized Approach may be used for projects with new and replaced hard surface areas up to 10,000 square feet. Under the Pre-sized Approach (refer to *Section 4.1.2*), pre-sized arched infiltration chambers may be used to achieve Pre-developed Pasture, Peak Control and Water Quality Treatment Standards. Sizing factors were not developed for other infiltration vault shapes other than arched infiltration chambers. Sizing factors and equations for infiltration chambers receiving runoff from a hard surface are provided in Table 5-265.28. Factors are organized by flow control standard, subgrade soil design infiltration rate, and contributing area. The design rate for the subgrade soils shall be rounded down to the nearest infiltration rate in the Table 5-265.28 (i.e., 0.15, 0.3, 0.6, 1.0, or 2.5 inch per hour).

To use these sizing factors or equations to meet flow control standards, the facility shall meet the general requirements for infiltration chambers outlined in this section, plus the following specific requirements:

- The chamber area shall be sized using the applicable sizing factor or equation.
- The aggregate storage reservoir shall be composed of Mineral Aggregate Type 4 or approved equal.

- The effective chamber storage depth (as calculated in the Modeling Approach below) shall be at least 2 feet.
- To use [these a](#) pre-sized infiltration chamber [facility](#) to meet water quality treatment, the underlying soil shall meet soil requirements specified in *Section 4.5.2*.
- Invert of overflow shall be set at top of the storage reservoir to provide the required storage reservoir depth used in the manufacturer's calculation of chamber [facility](#) storage volume.

[Infiltration c](#)Chambers that do not meet the above requirements shall use the Modeling Approach.

Table 5-265.28. Pre-Sized Sizing Factors and Equations for Infiltration Chambers.

Subgrade Soil Design Infiltration Rate	Contributing Area (sf)	Sizing Factor/Equation for Infiltration Chamber Area		
		Pre-developed Pasture Standard	Peak Control Standard	Water Quality Treatment Standard ^a
0.15 inch/hour	≤2,000	13.1%	12.6%	6.2%
	2,001 – 10,000	$[0.0879 \times A] + 91.4$		
0.3 inch/hour	≤2,000	11.1%	11.1%	5.1%
	2,001 – 10,000	$[0.0733 \times A] + 79.9$		
0.6 inch/hour	≤2,000	7.2%	8.0%	3.0%
	2,001 – 10,000	$[0.0441 \times A] + 56.8$		
1.0 inch/hour	≤2,000	6.4%	7.2%	2.6%
	2,001 – 10,000	$[0.0392 \times A] + 50.7$		
2.5 inch/hour	≤2,000	3.4%	4.3%	1.4%
	2,001 – 10,000	$[0.021 \times A] + 28$		

A – contributing hard surface area; sf – square feet.

For Sizing Factors: Infiltration Chamber Area (sf) = Contributing Hard Surface Area (sf) x Factor (%) / 100.

Hard Surface Area Managed (sf) = Chamber Area (sf) ÷ Factor (%) / 100.

For Sizing Equations: Infiltration Chamber Area (sf) = [Factor x A (sf)] + Integer.

Hard Surface Area Managed (sf) = [Chamber Area (sf) – Integer] ÷ Factor.

^a Pre-sized Approach may be used to meet basic water quality treatment. Enhanced water quality treatment may be achieved if soil suitability criteria are met (refer to *Section 4.5.2*).

The infiltration chamber [facility](#) area is calculated as a function of the area contributing runoff to the chamber [facility](#). As an example, to meet the Pre-developed Pasture Standard for a contributing area between 2,000 and 10,000 square feet where the subgrade infiltration rate is between 0.3 and 0.59 inch per hour, the chamber [facility](#) area would be calculated as: 0.0733 x contributing hard surface area + 79.9. All area values shall be in square feet.

Alternatively, infiltration chambers [and other shapes of infiltration vaults facilities](#) can be sized using a continuous hydrologic simulation model as described in the subsequent section.

Modeling Approach for On-site Performance Standard, Flow Control, and Water Quality Treatment

When using continuous hydrologic modeling to size infiltration chambers/[vaults](#), the assumptions listed in Table [5-275.29](#) shall be applied. It is recommended that infiltration

chambers/[vaults](#) be modeled as a pond with vertical side walls and a depth (controlled in the model by the height of the outlet structure) set equal to the effective depth of the chamber/[vault-facility](#). For a given chamber/[vault](#) type and size, the effective depth (i.e., the equivalent chamber/[vault-facility](#) storage depth assuming 100 percent voids) can be estimated based on the chamber/[vault-facility](#) storage volume (chamber/[vault](#) plus aggregate storage – typically obtained from the chamber/[vault](#) manufacturer) and chamber/[vault-facility](#) footprint area (including aggregate spacing between chambers/[vaults](#)). Storage volume provided by the manufacturer should assume 30 percent aggregate porosity unless test showing higher porosity is provided. For example, for a 4-foot-wide by 7-foot-long chamber/[vault](#) with 6-inch chamber/[vault](#) spacing and a manufacturer provided storage volume of 70 cubic feet (assuming 30 percent aggregate porosity), the effective depth would be calculated as follows:

Effective Storage Depth = Storage Volume (70 cubic feet – per manufacturer) ÷ Chamber/[Vault-Facility](#) Area where,

Chamber/[Vault](#) Area = Chamber/[Vault](#) Width including Spacing
(4 feet + 3 inches + 3 inches) x Chamber/[Vault](#) Length (7 feet).

Once the effective depth for a given chamber/[vault](#) system is established, the chamber/[vault](#) area or length should be iteratively sized until the Minimum Requirements for [Flow Control and/or Water Quality Treatment are met \(refer to Volume 1\) or where it has been determined by the Director that there is no offsite point of discharge for the project, the requirements of Section 4.3.2 are met. Flow Control are met \(refer to Volume 1, Section 5.3\).](#) General sizing procedures for infiltration [BMPsfacilities](#) are presented in [Section 4.5.1](#).

Table 5-275.29. Continuous Modeling Assumptions for Infiltration Chambers/[Vaults](#).

Variable	Assumption
Precipitation Series	Seattle 158-year, 5-minute series
Computational Time Step	5 minutes
HSPF Parameters	LSUR, SLSUR, NSUR shall be adjusted per Appendix F.
Inflows to Facility	Surface flow and interflow from total drainage area (including impervious and pervious contributing areas) routed to facility
Precipitation and Evaporation Applied to Facility	No
Total Depth	Effective storage depth plus freeboard
Subgrade Soil Design Infiltration Rate	Design infiltration rate (Section 4.5.2, Appendix D)
Infiltration Across Wetted Surface Area	No (bottom area only)
Outlet Structure	Specify riser diameter and riser height (set equal to the effective storage depth)

5.4.9.7. *Minimum Construction Requirements*

During construction, it is critical to prevent clogging and over-compaction of the subgrade. Refer to the minimum construction requirements for infiltration trenches in [Section 5.4.2.7](#).

5.4.9.8. Operations and Maintenance Requirements

General O&M requirements for infiltration facilities provided in *Appendix G (BMP No. 2)* apply to infiltration chambers/[vaults](#). Manufacturers of specific infiltration chambers/[vaults](#) may have additional O&M recommendations.

[Document a plan for cleaning and maintenance access for any equipment and personnel required for chambers and for vaults that are not as shown in Figure 5.22. If personnel will be entering the facility, a 24-inch-diameter ring and cover and 36-inch-diameter vertical pipe is required.](#)

5.5. Rainwater Harvesting BMPs

Rainwater harvesting BMPs capture and store rainwater for beneficial use. The BMPs in this section include:

- Rainwater harvesting
- Single-Family Residential (SFR) Cisterns

5.5.1. Rainwater Harvesting

5.5.1.1. Description

Rainwater harvesting is the capture and storage of rainwater for subsequent use. Runoff from roofs may be routed to cisterns for storage and beneficial non-potable uses, such as irrigation, mechanical equipment, industrial process uses, toilet flushing, and the cold water supply for laundry. The potable use of collected rainwater may be used for single-family residences with proper design and approval from Public Health – Seattle & King County.

Rainwater harvesting functions can be combined with detention pipes, vaults, and cisterns (refer to *Sections 5.7.2, 5.7.3, and 5.7.4*).

5.5.1.2. Performance Mechanisms

Rainwater harvesting can be used to achieve reductions in peak flows, flow durations and runoff volumes. The flow control performance of rainwater harvesting is a function of contributing area, storage volume and rainwater use rate.

5.5.1.3. Applicability

Rainwater harvesting systems can be designed to provide on-site stormwater management and flow control, and can be an effective volume reduction practice for projects where infiltration is not permitted or desired. Rainwater harvesting has higher stormwater management benefits when designed for uses that occur regularly through the wet season (e.g., toilet flushing and cold water laundry). The use of harvested rainwater for irrigation during the dry months provides less benefit.

This BMP can be applied to meet the requirements listed below.

BMP	On-site		Flow Control			Water Quality ^a				Conveyance
	List	Standard	Forest	Pasture	Peak	Basic	Enhanced	Oil Control	Phosphorus	
Rainwater Harvesting	✓	✓	✓	✓	✓					

^a Rainwater harvesting is not approved for pollution-generating surfaces, so the water quality [treatment](#) standard is not applicable.

5.5.1.4. Site Considerations

Rainwater harvesting can be used for new or retrofit projects. Depending upon site constraints, cisterns may be installed at grade, underground, under a deck, or in a basement or crawl space. Cisterns may be used individually or connected to each other in a series for increased storage capacity. Refer to *Appendix C* for additional infeasibility criteria for the On-site List Approach.

[Rainwater harvesting cisterns are allowed in the side, front, and rear yard/setbacks that are required by the Land Use Code \(SMC Title 23\) in certain land use zones. However, if the](#)

cistern extends above grade or sits above grade, then the amount of the yard/setback that it can cover may be restricted if the cistern is over a certain height, width, or total storage capacity. Height is measured from the lowest adjacent grade. Width is the outside width and is measured perpendicular to the setback line. Storage capacity is the total volume of water that can be stored in the cistern.

Refer to the Land Use Code (SMC Title 23) for the specific height, width, and storage capacity that trigger yard/setback coverage limitations for GSI features. Note: The requirements vary based on zoning and are not required in all zones.

5.5.1.5. Design Criteria

This section provides descriptions, recommendations, and requirements for the common components of rainwater harvesting systems. Design criteria are provided in this section for the following elements:

- Contributing area
- Collection system
- Prefilter
- Cistern/storage system
- Distribution system
- Water treatment system
- Overflow
- Backflow prevention device

The City accepts rainwater harvesting systems with indoor and/or outdoor water use for compliance with flow control standards. The indoor use of harvested water is regulated by Public Health – Seattle & King County.

In addition to the requirements presented in this section, all components of a rainwater harvesting system shall be designed and constructed in accordance with the manufacturer's recommendations and the City of Seattle Building and Residential Code, City of Seattle Plumbing Code, and Public Health – Seattle & King County requirements, and all other applicable laws.

Refer to the Puget Sound LID Manual and ARCSA/ASPE/ANSI 63-2013: Rainwater Catchment Systems for general guidance for design of rainwater harvesting systems. Refer to *Rainwater Harvesting and Connection to Plumbing Fixtures* (Public Health – Seattle & King County 2011) and the Puget Sound LID Manual for design requirements specific to indoor use of harvested rainwater.

Links to resources on rainwater harvesting, including permit requirements, are available at the SDCI website ([www.seattle.gov/sdci/codes/codes-we-enforce-\(a-z\)/stormwater-codewww.seattle.gov/dpd/codesrules/codes/stormwater](http://www.seattle.gov/sdci/codes/codes-we-enforce-(a-z)/stormwater-codewww.seattle.gov/dpd/codesrules/codes/stormwater)).

Contributing Area

The area contributing runoff to a rainwater harvesting system shall be a roof. Any rainwater collected from a vegetated roof underdrain may require additional treatment to remove tannins and suspended solids. Additionally vegetated roofs will naturally reduce the amount of water available for collection through the evapotranspiration of the plants and soil media.

Collection System

The collection system includes gutters and downspouts, as well as the piping and any other conveyance needed to route rainwater to the prefilter and on to the cistern.

Prefilter

A prefilter shall be provided with a debris screen that protects the cistern from the intrusion of debris, insects, vermin, or other organisms. The debris screen shall be corrosion resistant and shall have openings no larger than a nominal 0.15 cm (1,500 microns) (1/16 inch) or have been certified by a government regulatory agency to remove particles greater than 500 µm. A self-cleaning prefilter is recommended.

Cistern/Storage System

Cisterns can be constructed from a variety of materials (e.g., plastic, concrete, corrugated steel with liner, fiberglass) and placed in various locations. They can include tanks, pipes, and enclosed portions of buildings—above or underground. The minimum requirements for all cistern systems include the following:

- Cisterns shall be installed in accordance with manufacturer's installation instructions, the City of Seattle Building Code, and all applicable laws, including foundation and other structural requirements.
- Cistern/storage systems shall have access points and drains to allow inspection and cleaning.
- Cistern openings shall be designed to restrict entry from unauthorized personnel and appropriate signage shall be provided. Any cistern/storage system opening that could allow the entry of personnel shall be marked: "danger – confined space."
- Cleaning of any accumulated sediment on the bottom of the cistern shall be possible by flushing through a drain or vacuuming.
- Cisterns shall be designed to prevent mosquitoes and other nuisance insects and animals from entering the cistern system. This shall be done with 1/16-inch stainless steel mesh screening at all vents and other openings to the cistern.
- Opaque containers shall be used for aboveground cisterns to minimize algal growth.

Minimum requirements specific to underground cistern design include the following:

- Cistern/storage systems that are buried underground must-shall have a maintenance hole riser that protrudes a minimum of 8 inches above the surrounding ground. Maintenance hole covers shall be secured and locked to prevent tampering.

- Cistern/storage systems shall meet buoyancy resistance requirements per manufacturer's specifications, the City of Seattle Building Code, and the City of Seattle Plumbing Code.

Distribution System

Distribution of collected rainwater may be accomplished by gravity or by pumps and pipes to move water from the storage system to the end use area. For gravity fed irrigation use, an outlet spigot can be installed near the bottom of the tank. Water shall be drawn from at least 4 inches above the bottom of the tank or by use of a floating screened inlet in the tank. Any piping and/or fixtures containing collected rainwater shall be appropriately labeled per code.

Water Treatment System

Water quality treatment is typically required to protect the delivery and distribution system and to improve the quality of the collected water for the intended use. The pre-filter may be sufficient for a gravity fed irrigation system, while a pumped system for toilet flushing may require sediment filtration to 20 μ to 50 μ .

Additional discussion of treatment for indoor use is outside of the scope of this manual. Refer to the Puget Sound LID Manual and/or ARCSA/ASPE/ANSI 63-2013: Rainwater Catchment Systems for additional guidance on indoor use of harvested rainwater. Approval is required by Public Health – Seattle & King County for any project routing harvesting water to an indoor plumbing system.

Overflow

Minimum requirements associated with overflow design include the following:

- Overflows shall be designed to convey excess flow to the approved point of discharge per [Section 4.3.3](#).
- The overflow pipe shall have a conveyance capacity that is equal to or greater than all of the conveyance inlets delivering rainwater to the cistern. The minimum overflow pipe diameter shall be 4 inches.

Backflow Prevention Device

Refer to Public Health – Seattle & King County and the City of Seattle Plumbing Code for backflow prevention and cross-connection control requirements for back-up water supply.

5.5.1.6. *BMP Sizing*

Sizing for On-site List Approach

Rainwater harvesting may be selected to meet the On-site List Requirement [in Category 2 or Category 4](#) (refer to [Section 3.3.1](#) and [Appendix C](#) for infeasibility criteria). To meet the requirement [for Category 2 of the On-site List, document \(using the Modeling Approach described below\) that the rainwater harvesting system shall be designed to meet](#) the On-site Performance Standard [appropriate to the project for the contributing area \(refer to Modeling Approach for On-site Performance Standard and Flow Control\)](#).

If rainwater harvesting is selected for Category 4 of the On-site List, the rainwater harvesting system shall reduce discharged rooftop runoff volume by 25 percent on an average annual basis, as determined by an approved continuous simulation model. This reduction in runoff volume can be determined by comparing the total runoff from the roof and the average annual rainwater demand outlined in the following steps.

Step 1: Determine the average annual runoff volume from the tributary roof area

The roof area contributing to the rainwater harvesting system can be determined using the total runoff volume divided by the number of simulation years (e.g., 158 years).

Step 2: Determine the average annual runoff volume discharging as overflow from the rainwater harvesting system

This can be determined using the total discharged runoff volume divided by the number of simulation years (e.g., 158 years).

Step 3: Determine the ratio of the overflow discharge volume compared to the average annual runoff volume

Calculate the ratio of the numbers determined in Steps 1 and 2 (divide the average annual rainwater harvesting system overflow volume from Step 2 by the average annual roof runoff volume from Step 1). If the ratio is at least 0.75, the rainwater harvesting system meets the requirements for Category 4 of the On-site List.

Modeling Approach for On-site Performance Standard and Flow Control

If rainwater harvesting is selected for Category 2 of the On-site List, the on-site performance standard appropriate to the project shall be used to size the rainwater harvesting system. Rainwater harvesting systems can also be sized to meet flow control standards. The process for sizing a rainwater harvesting system to meet the on-site performance standard or a flow control standard is the same and is outlined in the following steps.

Step 1: Determine rainwater demand

When estimating rainwater demand for the purposes of modeling the on-site performance standard or a flow control standard, only year-round indoor uses may be included (e.g., seasonal irrigation may not be considered). Typical assumptions for non-potable and potable uses are provided in Tables 5-285.30 and 5-295.31 below.

Table 5-285.30. Typical Assumptions for Non-Potable Rainwater Demand Calculations.

Use	Assumptions	Source
Commercial Building Uses for Employees		
Number of employees	Actual ^a	
Employees that are male	50%	Assumed
Water closet (toilet) uses per male employee	1 use/day	LEED Reference Guide
Urinal uses per male employee	2 uses/day	LEED Reference Guide

Water closet uses per female employee	3 uses/day	LEED Reference Guide
Toilet and urinal fixture flow rates	Actual (gallons per use)	Manufacturer's data
Commercial Building Uses for Visitors		
Number of visitors	Actual ^b	
Water closet (toilet) uses per male visitor	0.2 use/day	LEED Reference Guide
Urinal uses per male visitor	0.1 use/day	LEED Reference Guide
Water closet (toilet) uses per female visitor	0.1 uses/day	LEED Reference Guide
Toilet and urinal fixture flow rates	Actual (gallons per use)	Manufacturer's data
Residential Building		
Water closet (toilet) uses per resident	5.1 uses per day per person	Rainwater Catchment Systems (ARCSA/ASPE/ANSI 63-2013) Table E.1
Toilet and urinal fixture flow rates	Actual (gallons per use)	Manufacturer's data
Cold water leg of laundry	80%	DeOreo and Mayer (Drinking Water Research, July–September 2012), WRF, Table 8
Laundry usage	0.310-37 loads/day/capita ^c	Residential End Uses of Water Executive Report, Version 2 Study (WRF 2016) Study (1999), AWWA
Residents per bedroom	2 for the first bedroom and 1 for each other bedroom per unit	Assumed

^a Typically not more than 1 employee per 2,000 sf of retail or 1 employee per 150 sf of office.

^b Typically not more than 150 visitors per day for commercial uses.

^c Derived from [3144](#) gallons/load and [9.645](#) gallons per day per person from the Residential End Uses of Water [Executive Report \(WRF 2016\) Study \(1999\), AWWA](#).

Table 5-295.31. Typical Assumptions for Potable Rainwater Demand Calculations.

Use	Usage	Duration	Source
Commercial Building Uses for Employees			
Lavatory faucet	3 uses/day	30 seconds/use	LEED Reference Guide
Shower	0.1 uses/day	300 seconds/use	LEED Reference Guide
Kitchen sink	1 use/day	15 seconds/use	LEED Reference Guide
Faucet, shower and sink fixture flow rates	Actual (gallons/minute)	–	Manufacturer's data
Commercial Building Uses for Visitors			
Lavatory faucet	0.5 use/day	30 seconds/use	LEED Reference Guide
Faucet fixture flow rates	Actual (gallons/minute)	–	Manufacturer's data
Residential Building Uses^a			
Faucets	11.140.9 gallons/day/capita	–	Residential End Uses of Water Executive Report, Version 2 Study (WRF 2016+1999)-AWWA
Shower	11.144.6 gallons/day/capita	–	Residential End Uses of Water Executive Report, Version 2 Study (WRF 2016+1999)-AWWA
Bath	1.5 gallons/day/capita	=	Residential End Uses of Water Executive Report, Version 2 (WRF 2016)
Dishwasher	0.7 gallons/day/capita	=	Residential End Uses of Water Executive Report, Version 2 (WRF 2016)
Faucet and shower fixture flow rates	Actual (gallons/minute)	–	Manufacturer's data

^a Additional residential potable water use rates can be obtained from [the Water Research Foundation \(WRF 2016\) executive report: www.allianceforwaterefficiency.org/resources/residential-end-uses-of-water-study-1999.aspx](http://www.allianceforwaterefficiency.org/resources/residential-end-uses-of-water-study-1999.aspx). This study is in the process of being updated and new data may be available in 2015 or 2016.

Daily demand is calculated for each use as shown in the examples below:

- Water closet demand for female employees in commercial building (gallons/day) = total number of employees x 50 percent x 3 uses/day x toilet flow rate (gallons/use)
- Lavatory faucet demand for visitors in commercial building (gallons/day) = [number of visitors per day x 0.5 uses/day x 30 seconds/use x faucet flow rate (gallons/minute)] ÷ 60 seconds/minute

The rainwater uses are summed to calculate a total daily demand in gallons per day. For commercial buildings that do not operate daily, a multiplier is applied to the total demand (i.e., a multiplier of 5/7 is applied if business is open 5 days per week).

The average demand (D) in cubic feet per hour is then calculated by dividing the demand in gallons per day by 179.5. The rainwater demand is then reduced by a factor of 10 percent (multiplied by a factor of 0.9) to account for lower than anticipated water use (e.g., periods of vacancy).

Step 2: Calculate the “Infiltration Rate” Equivalent to the Rainwater Demand

In order to represent the daily rainwater demand in the continuous simulation model, the equivalent cistern “infiltration rate” is calculated as follows:

Equivalent Cistern “Infiltration Rate” (inch/hour) = $D \times (12 \text{ inches/foot})/A$, where:

D = Average Daily Rainwater Demand (cubic feet per hour)

A = Cistern Footprint Area (square feet)

Step 3: Determine Contributing Roof Area

The actual roof area draining to the cistern is the contributing roof area.

Step 4: Integrate Rainwater Harvesting into Development Site Model

In an approved continuous hydrologic model, runoff from the contributing roof area is directed to a storage element (e.g., vault, cistern) with an infiltration routine to represent the cistern with rainwater use (refer to Table [5-305.32](#)). The equivalent “infiltration rate,” calculated as shown above, is applied to the bottom area of the storage element. The size of the storage element and/or the equivalent “infiltration rate” (rainwater use rate) are adjusted to achieve the desired level of performance. Note that when the storage element size is modified, the equivalent “infiltration area” shall be updated based on the new cistern footprint area (refer to the equation in Step 2).

If rainwater harvesting does not achieve the applicable stormwater performance standard(s), overflow from the storage element can be routed to a downstream stormwater management practice (e.g., detention, bioretention) that can be sized to meet the standard(s).

Table [5-305.32](#). Continuous Modeling Assumptions for Rainwater Harvesting.

Variable	Assumption
Precipitation Series	Seattle 158-year, 5-minute series
Computational Time Step	5 minutes
HSPF Parameters	LSUR, SLSUR, NSUR shall be adjusted per Appendix F
Inflows to Cistern	Surface flow from drainage area (roof area) routed to facility
Storage in Cistern	Storage element (e.g., vault, cistern)
Rainwater Demand	Represent rainwater demand as an equivalent “infiltration rate” applied to the bottom of the storage element
Outlet Structure	Overflow elevation set at live storage depth. May be modeled as weir flow over riser edge. Note that freeboard shall be sufficient to allow water surface elevation to rise above the overflow elevation to provide head for discharge.

5.5.1.7. Minimum Construction Requirements

Rainwater harvesting systems shall be constructed according to the manufacturer’s recommendations, the City of Seattle Building Code, the City of Seattle Plumbing Code, and all applicable laws.

5.5.1.8. Operations and Maintenance Requirements

Rainwater harvesting O&M requirements are provided in *Appendix G (BMP No. [2423](#))*.

Additional O&M guidance can be found in ARCSA/ASPE/ANSI 63-2013: Rainwater Catchment Systems.

5.5.2. Single-Family Residential (SFR) Cisterns

5.5.2.1. Description

Detention cisterns (*Section 5.7.4*) can be designed to allow rainwater harvesting of roof runoff for outdoor irrigation use. For single-family residential (SFR) projects, these are combined harvesting and detention cisterns (referred to as SFR cisterns).

The SFR cistern requires seasonal operation of a valve to detain water through the winter months.

5.5.2.2. Performance Mechanisms

SFR cisterns provide flow attenuation by slowly releasing low flows through an orifice.

5.5.2.3. Applicability

SFR cisterns can be applied to meet the requirements listed below.

BMP	On-site		Flow Control			Water Quality				Conveyance
	List	Standard	Forest	Pasture	Peak	Basic	Enhanced	Oil Control	Phosphorus	
SFR Cisterns	✓									

5.5.2.4. Site Considerations

SFR cisterns can be used on any new or retrofit single-family residential project. Refer to *Appendix C* for additional infeasibility criteria for the On-site List Approach.

[SFR cisterns are allowed in the side, front and rear yard/setbacks that are required by the Land Use Code \(SMC Title 23\) in certain land use zones. However, the amount of the yard/setback that it can cover may be restricted if the cistern is over a certain height, width, or total storage capacity. Height is measured from the lowest adjacent grade. Width is the outside width and is measured perpendicular to the setback line. Storage capacity is the total volume of water that can be stored in the cistern.](#)

[Refer to the Land Use Code \(SMC Title 23\) for the specific height, width, and storage capacity that trigger yard/setback coverage limitations for GSI features. Note: The requirements vary based on zoning and are not required in all zones.](#)

5.5.2.5. Design Criteria

The following provides descriptions, recommendations, and requirements for the common components of cistern detention systems. A schematic for a typical SFR cistern are shown in Figure [5.235-19](#). Design criteria are provided in this section for the following elements:

- Contributing area

- Collection system
- Screen/debris excluder
- Cistern
- Flow control orifice
- Overflow

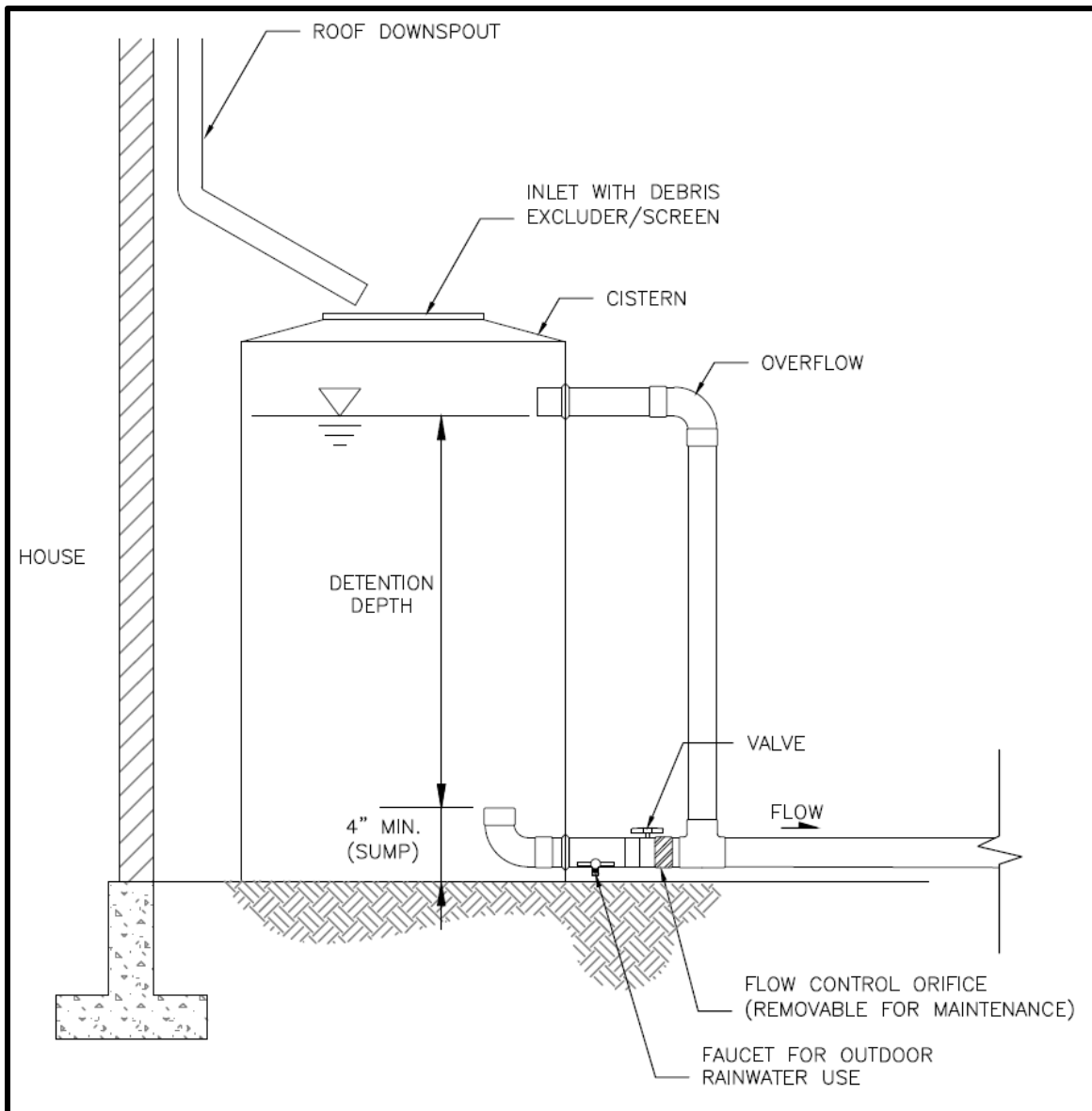

Figure 5.235-19. Detention Cistern with Harvesting Capacity for Single-Family Residential Projects Only.

Contributing Area

The area contributing runoff to a SFR cistern shall not be pollution generating (e.g., surfaces subject to vehicular traffic are not acceptable).

To protect the water quality of the rainwater harvested, avoid collecting runoff from roof surfaces composed of materials such as copper or zinc that may release contaminants into your system. Also avoid collecting runoff from roof materials treated with fungicides or herbicides.

Collection System

Collection systems include gutters and downspouts, as well as piping and any other conveyance needed to route runoff from the roof to the cistern.

Rainwater use shall be for outdoor irrigation uses only.

Screens/Debris Excluder

A filter screen or other debris barrier is required to prevent insects, leaves, and other larger debris from entering the system. A self-cleaning inlet filter is recommended.

Cistern

Cisterns are commonly constructed of fiberglass, polyethylene, concrete, metal, or wood. Tanks can be installed at or below grade, and individually or in series.

Minimum requirements associated with cistern design include the following:

- If cistern height exceeds 4.5 feet (excluding piping), width exceeds 4 feet, or storage volume exceeds 600 gallons, the cistern may be subject to stricter Land Use Code (SMC Title 23) setback requirements.
- All cisterns ~~must~~ shall be installed in accordance with manufacturer's installation instructions.
- Cisterns shall be designed to prevent mosquitoes and other nuisance insects and animals from entering the cistern system. This can be done with tight-fitting covers and appropriate screening at all openings to the cistern.
- Opaque containers shall be used for aboveground cisterns to prevent penetration of sunlight to minimize algal growth.
- Minimum cistern size shall be that of a rain barrel (typically 55 gallons).

Flow Control Orifice

Minimum requirements associated with flow control orifice design include the following:

- Cisterns shall be aboveground and have an orifice diameter of 0.25 inch.
- Minimum 4-inch sump shall be provided to protect the orifice from sediment.

Overflow

Cisterns shall have an overflow to convey water exceeding the detention capacity of the system to an approved point of discharge or another BMP (e.g., bioretention area, vegetated cell, or infiltration trench) per *Section 4.3.3*. Conveyance may be provided by gravity flow or by pumps, but gravity flow is preferred.

5.5.2.6. BMP Sizing

Sizing for On-site List Approach

SFR cisterns may be selected to meet the On-site List Requirement (refer to *Section 3.3.1* and *Appendix C* for infeasibility criteria). The area draining to a properly sized cistern meets the requirement. The cistern area sizing factors and minimum live storage depths are provided in [Table 5-315.33](#). Three to five feet of live storage between the low flow orifice and the overflow must shall be provided, and the low flow orifice shall have a diameter of 0.25 inch.

Table 5-315.33. On-site List Sizing for SFR Cisterns.

Contributing Area (square feet)	Sizing Factor Cistern Bottom Area ^a	Minimum Live Storage Depth ^b (ft)
	On-site Performance Standard	
400–799	3.6%	3.0
800–899	2.8%	4.0
900–999	2.4%	
1,000–1,099	2.0%	
1,100–1,199	1.7%	
1,200–1,299	1.4%	
1,300–1,399	1.4%	5.0
1,400–1,899	1.3%	
1,900–1,999	1.2%	
2,000–2,999	1.6%	
3,000–4,200	1.9%	

sf – square feet.

Cistern Area = Contributing Hard Surface Area x Factor (%) / 100.

Hard Surface Area Managed = Cistern Area ÷ Factor (%) / 100.

^a Sizing factors based on achieving an 85% reduction in the 1-year recurrence interval flow.

^b Detention depth refers to live storage depth (i.e., does not include freeboard or sediment storage requirements).

5.5.2.7. Minimum Construction Requirements

Refer to the construction-related issues outlined above as part of the design criteria. An additional construction requirement is as follows:

- Submit field changes to the flow control device assembly, including elevation changes, to the Engineer of Record for confirmation that the device still meets the design requirements.

5.5.2.8. Operations and Maintenance Requirements

SFR cistern O&M requirements are provided in *Appendix G (BMP No. 2423)*.

The home owner shall open the valve to engage the flow control orifice during the non-growing season (approximately October through April or May). If the valve is not opened during this time, the cistern will fill and overflow, eliminating the detention benefits of the system. A plan shall be submitted demonstrating how the O&M requirements will be met.

5.6. Alternative Surface BMPs

Alternative surface BMPs convert a conventional impervious surface to a surface that reduces the amount of stormwater runoff and also provides flow control. The BMPs in this section include:

- Vegetated roof systems
- Permeable pavement surfaces

5.6.1. Vegetated Roof Systems

5.6.1.1. Description

Vegetated roofs are areas of living vegetation installed on top of buildings, or other above-grade impervious surfaces [\(e.g., at least 10 feet above grade\)](#). Vegetated roofs are also known as ecoroofs, green roofs, and roof gardens.

A vegetated roof consists of a system in which several materials are layered to achieve the desired vegetative cover and stormwater management function (refer to [Figure 5.245-20](#)). Design components vary depending on the vegetated roof type and site constraints, but may include a waterproofing material, a root barrier, a drainage layer, a separation fabric, a growth media (soil), and vegetation. Vegetated roof systems are categorized by the depth and the types of courses used in their construction.

- **Intensive roofs:** Intensive roofs are deeper installations, composed of at least 6 inches of growth media and planted with ground covers, grasses, shrubs and sometimes trees.
- **Extensive roofs:** Extensive roofs are shallower installations, composed of less than 6 inches of growth media and planted with a palette of drought-tolerant, low maintenance ground covers. Extensive vegetated roofs have the lowest weight and are typically the most suitable for placement on existing structures. Extensive systems are further divided into two types:
 - Single-course systems consist of a single growth media designed to be freely draining and support plant growth.
 - Multi-course systems include both a growth media layer and a separate, underlying drainage layer.

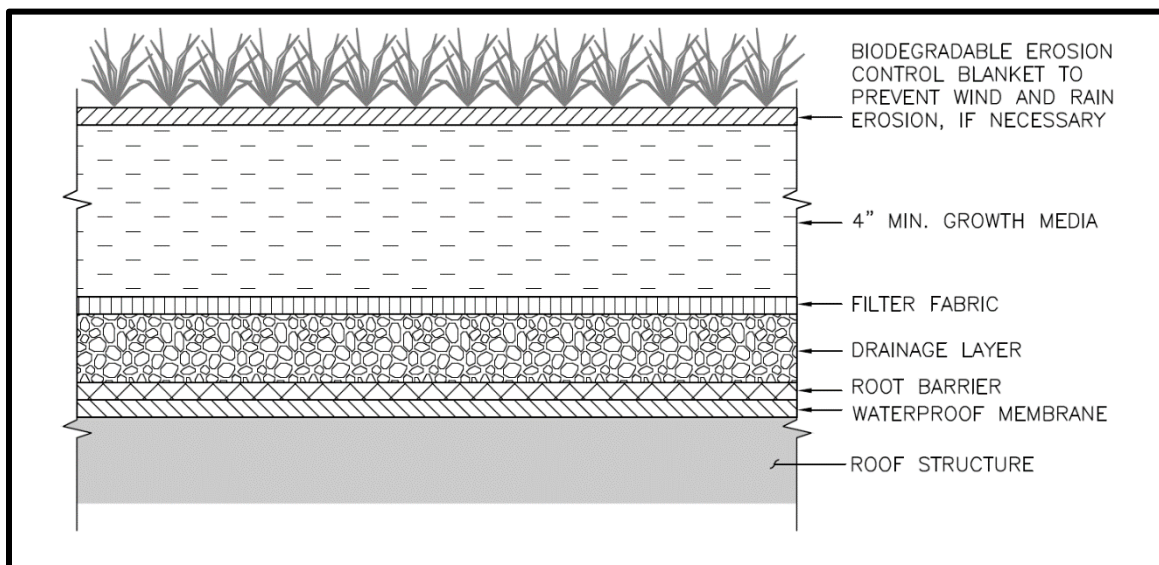

Figure [5.245-20](#). Vegetated Roof System.

The following types of vegetated roof systems are acceptable for flow control compliance:

- Intensive systems
- Extensive multi-course systems (and commercially available modular systems) with at least 4 inches of growth media
- Extensive single-course systems with at least 4 inches of growth media

5.6.1.2. Performance Mechanisms

Vegetated roof systems can provide flow control via attenuation, soil storage, and losses to interception, evaporation, and transpiration.

5.6.1.3. Applicability

Vegetated roof systems can be designed to provide on-site stormwater management and flow control. The degree of flow control provided by vegetated roofs varies depending on the growth media (soil) depth, growth media composition, drainage layer characteristics, vegetation type, roof slope, and other design considerations. This BMP can be applied to meet or partially meet the requirements listed below.

BMP	On-site		Flow Control			Water Quality				Conveyance
	List	Standard	Forest	Pasture	Peak	Basic	Enhanced	Oil Control	Phosphorus	
Vegetated Roof System	✓	✓ ^a	✓ ^a	✓ ^a	✓ ^a					

^a Standard may be partially achieved.

5.6.1.4. Site Considerations

Vegetated roof systems for stormwater management are accepted for roof slopes between 1 and 22 degrees (0.2:12 and 5:12), but require additional analysis at slopes exceeding 10 degrees (2:12).

A primary consideration for the feasibility of vegetated roofs is the structural capability of the roof and building structure. Related factors, including design load, slipping and shear issues, and wind load, are outside the scope of this manual. Refer to the City of Seattle Building Code for structural requirements. Refer to *Appendix C* for additional infeasibility criteria for the On-site List.

5.6.1.5. Design Criteria

The following sections provide a description, recommendations, and requirements for the common components of vegetated roof systems. Typical components of a vegetated roof are shown in Figure [5.245-20](#). Design criteria are provided in this section for the following elements:

- Roof slope
- Vegetation
- Growth media
- Drainage layer
- Drain system and overflow

While vegetated roofs will include additional system components (e.g., waterproof membrane, root barrier, separation fabric for multi-course systems), the design and construction requirements for these components are outside of the scope of this manual.

Refer to the Puget Sound LID Manual for a more detailed description of the components of and design criteria for vegetated roofs, as well as additional references and design guidance.

Roof Slope

Vegetated roofs can be applied to a range of rooftop slopes; however, steeper slopes may result in reduced flow control performance and may warrant a more complicated design (e.g., lateral support measures). Roofs with slopes between 1 and 5 degrees (0.2:12 and 1:12) are the easiest to install, are the least complex, and generally provide the greatest stormwater storage capacity per inch of growth media.

For on-site or flow control compliance, the roof slope shall be between 1 and 22 degrees (0.2:12 and 5:12). Roofs with slopes greater than 10 degrees (2:12) require an analysis of engineered slope stability.

Vegetation

Vegetation used on extensive vegetated roofs shall be drought tolerant, self-sustaining, low maintenance, and perennial or self-sowing. Appropriate plants should also be able to withstand heat, cold, periodic inundation and high winds. Vegetation with these attributes typically includes succulents, grasses, herbs, and wildflowers that are adapted to harsh conditions. Refer to the Green Factor plant list (SDCI Director's Rule 10-2011). Refer to the Puget Sound LID Manual for additional vegetation guidance for vegetated roofs.

Minimum requirements associated with vegetation design include the following:

- The design plans shall specify that vegetation coverage of selected plants will achieve 80 percent coverage within 2 years.
- For non-single family residential projects, plant spacing and plant size shall be designed to achieve specified coverage by a licensed landscape architect.
- Vegetation shall be suitable for rooftop conditions (e.g., hot, cold, dry, and windy).
- Plants shall not require fertilizer, pesticides or herbicides after 2-year establishment period. Application of fertilizer, pesticides or herbicides shall be minimized after a 3-year establishment period.

Note: Vegetated roofs may require fertilizer for establishment and long-term health. The goal of fertilization is to support plant health and vigor while also minimizing the amount of nutrient runoff within stormwater. During the first 3 years of

establishment, a granular, slow-release fertilizer with a target N-P-K ratio of 18-6-12 or a generic 10-10-10 is recommended. Application should occur during the spring growing season. After initial plant establishment, vegetation should be monitored and soil should be tested annually or every other year to determine whether additional fertilizer applications are necessary. Fertilizer should not be applied during the hottest and driest parts of the year when plants are dormant or not actively growing. Fertilizer should not be over-applied. Vegetated roofs have excellent drainage and are intended to help reduce pollutants that result from stormwater runoff. Fertilizing should be conducted carefully and strategically to avoid water quality impacts.

Growth Media

Vegetated roof systems use a light-weight growth media with adequate fertility and drainage capacity to support plants and allow filtration and storage of water. Growth media composition (fines content and water holding capacity) is key to flow control performance. Refer to the Puget Sound LID Manual for additional guidance on growth media design.

Minimum requirements associated with the growth media design include the following:

- The growth media shall be a minimum of 4 inches deep. Refer to the SDCI website ([www.seattle.gov/sdci/codes/codes-we-enforce-\(a-z\)/stormwater-codes](http://www.seattle.gov/sdci/codes/codes-we-enforce-(a-z)/stormwater-codes)~~www.seattle.gov/dpd/codesrules/codes/stormwater~~) for a growth media specification. Approved media testing labs and approved media products are also provided on the website.
- For non-single family residential projects, growth media depth and characteristics shall support growth for selected plant species and shall be approved by a licensed landscape architect.
- Vegetated roofs shall not be subject to any use that will significantly compact the growth media.
- Unless designed for foot traffic, vegetated roof areas that are accessible to the public shall be protected (e.g., signs, railing, fencing) from foot traffic and other loads.
- Biodegradable erosion control blanket or other measures to control erosion of growth media shall be maintained until 90 percent vegetation coverage is achieved.

Drainage Layer

Intensive and extensive multi-course vegetated roof systems shall include a drainage layer below the growth media. The drainage layer is a multipurpose layer designed to provide void spaces to hold a portion of the water that passes through the growth media and to channel the water to the roof drain system. The drainage layer can consist of a layer of aggregate or a manufactured mat or board that provides an open free draining area. Many manufactured products include egg carton shaped depressions that retain a portion of the water for eventual evapotranspiration.

Drain System and Overflow

Vegetated roof systems shall be equipped with a roof drainage system capable of collecting subsurface and surface drainage and conveying it safely to a downstream BMP or an approved

point of discharge. To facilitate subsurface drainage, interceptor drains (i.e., underdrains) are often installed at a regular spacing to prevent excessive moisture build up in the media and convey water to the roof drain. Roof outlets shall be protected from encroaching plant growth and loose gravel, and shall be constructed and located so that they are permanently accessible.

5.6.1.6. BMP Credits

Credit for On-site List Approach

A vegetated roof system may be selected to meet the On-site List Requirement (refer to *Section 3.3.1* and *Appendix C* for infeasibility criteria). The hard surface area covered by a vegetated roof system meets the requirement. To account for roof areas that cannot feasibly be covered by a vegetated roof system (e.g., access ways, roof vents), the entire roof area meets the On-site List Requirement if 80 percent of the roof is covered by a vegetated roof. If a smaller portion of the roof is covered by a vegetated roof, only the covered portion of the roof meets the On-site List Requirement and an additional BMP is required for the remaining area.

Pre-sized Approach for Flow Control

The Pre-sized Approach may be used for projects with new and replaced hard surface areas up to 10,000 square feet. Under the Pre-sized Approach (refer to *Section 4.1.2*), flow control credits towards meeting the Pre-developed Pasture and Peak Control Standards may be partially achieved by vegetated roof systems. Credits for vegetated roofs are provided in [Table 5-325.34](#), organized by performance standard and growth media depth. These credits can be applied to reduce the hard surface area requiring flow control. Since the credits for vegetated roofs are less than 100 percent, the standard is not completely achieved and additional flow control measures will be required. As an example, for a site subject to the Peak Control Standard, a vegetated roof would receive an ~~80%~~ 86 percent credit. Therefore, 86 percent of the impervious area covered by the vegetated roof can be excluded from drainage calculations. The impervious area used to size the downstream flow control facility would be calculated as ~~20%~~ 14 percent of the impervious area covered by the vegetated roof.

Table 5-325.34. Pre-sized Flow Control Credits for Vegetated Roofs.

Vegetated Roof Type	Credit (%)	
	Pre-developed Pasture Standard	Peak Control Standard
Single or Multi Multi-Course/ 4 inch minimum media depth	16% 24%	80% 86%

Impervious Area Managed = Vegetated roof Area x Credit (%) / 100.

The flow control credits outlined above are applicable only if the vegetated roof meets the minimum design requirements outlined in this section and the minimum media depth specified in [Table 5-325.34](#).

Alternatively, vegetated roofs can be sized using a continuous model as described below.

Modeling Approach for On-site Performance Standard and Flow Control

When using continuous simulation hydrologic modeling to quantify the on-site stormwater management and/or flow control performance of vegetated roof systems, the assumptions listed in Table 5-335.35 shall be applied. It is recommended that vegetated roofs be modeled as layers of aggregate with surface flows, interflow, and exfiltrating flow routed to an outlet.

Table 5-335.35. Continuous Modeling Assumptions for Vegetated Roof Systems.

Variable ^a	Assumption
Precipitation Series	Seattle 158-year, 5-minute series
Computational Time Step	5 minutes
HSPF Parameters	LSUR, SLSUR, NSUR shall be adjusted per Appendix F
Inflows to Facility	None
Precipitation and Evaporation Applied to Facility	Yes
Depth of Material (inches)	Growth media/soil depth (minimum of 4 inches). Currently, MGSFlood and the Western Washington Hydrology Model (WWHM) are not capable of representing the flow control benefits of the drainage layer or other storage beneath the growth media.
Vegetative Cover	Ground cover or shrubs. Shrubs are appropriate only when growth media is 6 inches or greater.
Length of Rooftop (ft)	The average surface flowpath length of the surface flow path to from the most upstream point to the roof drain
Slope of Rooftop (ft/ft)	The slope of the vegetated roof
Discharge from Facility	Surface flow, interflow and exfiltrated flow from vegetated roof module routed to downstream BMP or point of compliance. Note that the exfiltrated flow (flow infiltrated through the media and collected by the drainage layer) is tracked as groundwater in MGSFlood and WWHM.

^a Depending upon the hydrologic model used, some inputs may not be requested.

The media depth can be modified to achieve various degrees of flow control. Because the on-site stormwater management and flow control standards cannot typically be achieved using a vegetated roof, additional downstream flow control measures may be required.

5.6.1.7. Minimum Construction Requirements

The growth media shall be protected from over compaction during construction.

5.6.1.8. Operations and Maintenance Requirements

Vegetated roof system O&M requirements are provided in *Appendix G (BMP No. 2827)*. A Landscape Management Plan shall be developed and implemented for vegetation O&M. [Irrigation shall be provided for a minimum of five growing seasons. If an irrigation system is included, An Irrigation Design and Operation Plan shall be included in the Vegetated Roof Maintenance Landscape Management Plan.](#)

5.6.2. Permeable Pavement Surfaces

5.6.2.1. Description

Permeable pavement is a paving system which allows rainfall to percolate into the underlying subgrade. Two categories of permeable pavement BMPs are included in this manual: permeable pavement surfaces and permeable pavement facilities. A comparison of these BMPs is provided in *Section 5.4.6*.

A permeable pavement surface consists of a pervious wearing course (e.g., porous asphalt, pervious concrete) and an aggregate subbase installed over subgrade soil. The aggregate subbase is designed to manage only the water that falls upon it. Because permeable pavement surfaces are designed to function as a permeable land surface and not intended to manage runoff from other surfaces, they are not considered infiltration facilities and have less onerous siting and design requirements.

5.6.2.2. Performance Mechanisms

Flow control occurs through temporary storage of stormwater runoff in the voids of the aggregate material and subsequent infiltration of stormwater into the underlying soils. Pollutant removal mechanisms include infiltration, filtration and sedimentation, biodegradation, and soil adsorption.

5.6.2.3. Applicability

Permeable pavement surfaces can be designed to provide on-site stormwater management, flow control and/or water quality treatment. This BMP can be applied to meet or partially meet the requirements listed below.

BMP	On-site		Flow Control			Water Quality				Conveyance
	List	Standard	Forest	Pasture	Peak	Basic	Enhanced	Oil Control	Phosphorus	
Permeable Pavement Surface	✓	✓	✓ ^a	✓ ^a	✓ ^a	✓ ^{a, b}	✓ ^{a, b}			

^a Standard may be partially or completely achieved depending upon subgrade slope, infiltration rate of subgrade soil, and whether aggregate subbase is laid above or below surrounding grade.

^b Underlying soil shall meet the treatment soil requirements outlined in *Section 4.5.2* or a water quality treatment course shall be included per *Section 5.4.6.54-5.6.5*.

5.6.2.4. Site Considerations

Since permeable pavement surfaces are not designed to receive runoff from other surfaces and are designed to function as a permeable land surface, they are not considered infiltration facilities. Therefore, the restrictions related to infiltration facilities (e.g., restrictions, setbacks, separation from groundwater) are not applicable. An exception is that infiltration testing is required for permeable pavement surfaces when hydrologic modeling will be conducted to evaluate performance relative to the flow control, water quality treatment or

On-site Performance Standard. Site considerations for the applicability of permeable pavement surfaces include:

- **Site topography:** The recommended maximum surface (wearing course) slope for permeable pavement surfaces is 6 percent to allow efficient storage of water within the subbase. For vehicular traction, the maximum surface slope varies by wearing course type (refer to industry guidelines). Minimum wearing course slope shall be 1 percent unless provision is made for positive drainage in event of surface clogging.

The recommended maximum subgrade slope for permeable pavement applications is 6 percent. Subgrades with slopes exceeding 5 percent require subsurface check dams to promote storage in the subgrade. At steeper subgrades slopes, design and construction become more complex and the construction cost increases.
- **Land use:** Because permeable pavement can clog with sediment, permeable pavement surfaces are not recommended where sediment and pollutant loading is unavoidable, including the following conditions:
 - Excessive sediment contamination is likely on the pavement surface (e.g., construction areas, landscaping material yards).
 - It is infeasible to prevent stormwater run-on to the permeable pavement from unstabilized erodible areas without presettling.
 - Regular, heavy application of sand is anticipated for maintaining traction during winter, or the facility is in close proximity to areas that will be sanded. A minimum seven foot clearance is required between a permeable pavement facility and the travel lane of sanded arterial roads.
 - Sites where the risk of concentrated pollutant spills are more likely (e.g., gas stations, truck stops, car washes, vehicle maintenance areas, industrial chemical storage sites).
- **Accessibility:** As for standard pavement design, ADA accessibility issues shall be addressed when designing a permeable pavement surface, particularly when using pavers.
- **Subsurface contamination:** Permeable pavement surfaces shall not be sited:
 - Within 10 feet of an underground storage tank (or connecting underground pipes) used to store petroleum products, chemicals, or liquid hazardous wastes
 - Where the site is a contaminated site or abandoned landfill

Refer to *Appendix C* for additional infeasibility criteria for the On-site List Approach.

5.6.2.5. Design Criteria

This section provides descriptions, recommendations, and requirements for the common components of permeable pavement surfaces. Some, or all, of the components may be used for a given application depending on the permeable pavement type (e.g., porous asphalt, pavers, etc.), site characteristics and restrictions, and design objectives. Typical components of a permeable pavement surface are shown in Figure [5.255-21](#). The design criteria for the following components are the same as those presented for permeable pavement facilities (refer to *Section 5.4.6*):

- Wearing course
- Leveling course
- Subgrade
- Geotextile
- Water quality treatment course

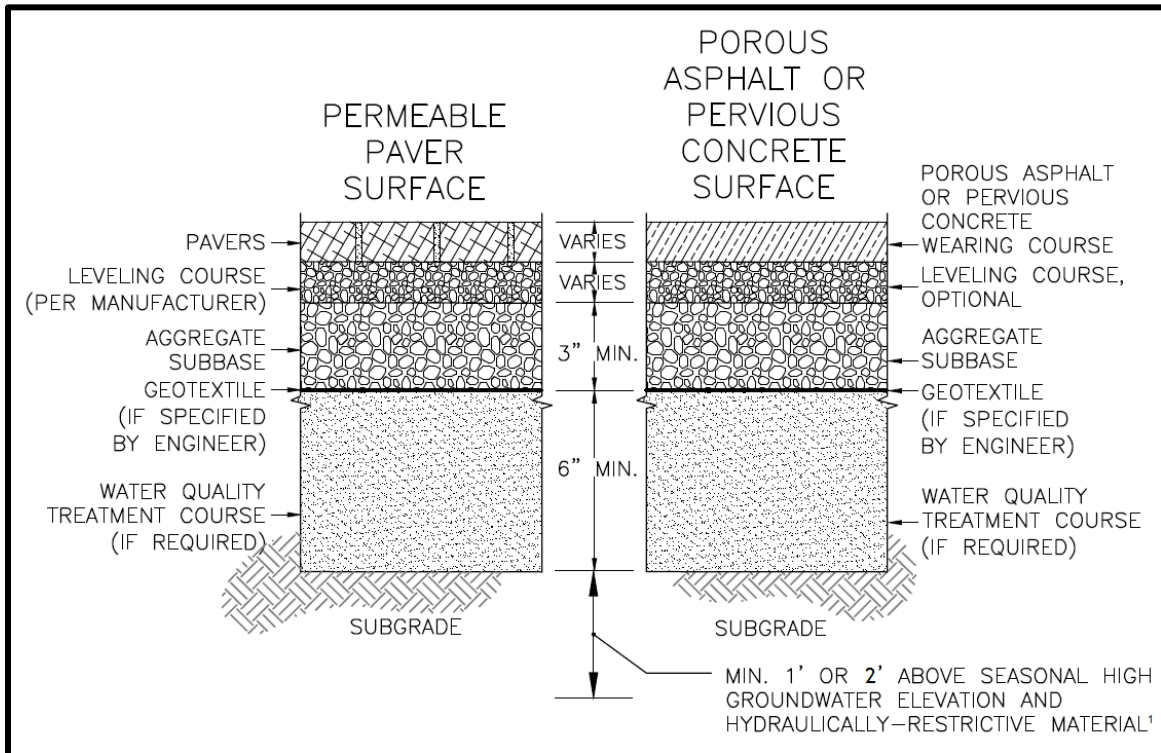

¹ See Table C.3 of Appendix C to determine. Subsurface investigation is not required for permeable pavement surfaces, but subsurface investigation must be performed to demonstrate infeasibility due to lack of vertical separation.

Figure 5.255-21. Permeable Pavement Surface.

The requirements for the following components differ from permeable pavement facilities and the design criteria for these components are provided below.

- Contributing area
- Aggregate subbase
- Subgrade
- Subsurface check dams
- Overflow

Note that, unlike permeable pavement facilities, observation ports are not required, flow entrances, presettling, and underdrains are not applicable, and the aggregate is referred to as an aggregate subbase instead of storage reservoir.

The structural design of permeable pavement to support anticipated loads is outside the scope of this manual.

The Puget Sound LID Manual provides additional guidance on permeable pavement design.

Contributing Area

Permeable pavement surfaces shall not be designed to receive significant runoff from other areas (run-on). In no case may the surface receive run-on from an impervious area greater than 10 percent of the permeable pavement area. Any run-on shall be dispersed. To prevent sediment flowing onto the pavement, run-on shall not occur from erodible/unstabilized areas or from impervious areas that receive run-on from unstabilized areas.

Aggregate Subbase

Stormwater passes through the wearing and leveling courses to an underlying aggregate subbase where it is filtered and stored prior to infiltration into the underlying soil. This aggregate also serves as the pavement's support base and shall be sufficiently thick to support the expected loads. Design of the subgrade for loading is outside of the scope of this manual. A licensed engineer is needed to determine subsoil load bearing, minimum aggregate base thickness, and aggregate compaction for loading.

Minimum requirements associated with the aggregate subbase design include the following:

- A 3-inch minimum depth of aggregate subbase is required. Note that more depth may be needed for constructability and placement of the subbase material (due to size of rock in the subbase) and for structural design support.
- The aggregate base shall have a minimum total void volume of 25 percent after compacted in place. Percent voids (porosity) shall be determined in accordance with ASTM C29/C29M. Use the jigging procedure to densify the sample (do not use the shoveling procedure).
- Aggregate material shall have 0 to 2 percent passing #200 wet sieve.
- For walkways, the following aggregate materials are recommended and meet the requirements listed above:
 - City of Seattle Mineral Aggregate Type 24
 - Modified AASHTO #57 per WSDOT [20202014](#) Section 9-03.1(4)C with 0 to 2 percent passing #200 wet sieve; percent fracture shall be in accordance with requirements per WSDOT [20202014](#) 9-03.9(2).
- For vehicular applications, the following aggregate materials are recommended and meet the requirements listed above:
 - City of Seattle Mineral Aggregate Type 13
 - Modified AASHTO #57 per WSDOT [20202014](#) Section 9-03.1(4)C with 0 to 2 percent passing #200 wet sieve; percent fracture shall be in accordance with requirements per WSDOT [20202014](#) 9-03.9(2).
 - Permeable ballast per WSDOT [20202014](#) Section 9-03.9(2)

Subgrade

The minimum measured subgrade infiltration rate for permeable pavement surfaces is 0.3 inch per hour. Note that infiltration testing is not required to use permeable pavement surfaces to meet the On-site List Approach, but may be used to demonstrate infeasibility

(i.e., infiltration rates less than 0.3 inch per hour). If permeable pavement surfaces are to be used to meet the water quality treatment requirement, underlying soil shall meet the treatment soil requirements outlined in *Section 4.5.2* or a water quality treatment course shall be included.

During construction the subgrade soil surface can become smeared and sealed by excavation equipment. The design shall require scarification or raking of the side walls and bottom of the facility excavation to a minimum depth of 4 inches after excavation to restore infiltration rate.

Subsurface Check Dams

Sloped facilities have an increased potential for lateral flows through the aggregate subbase along the top of the relatively impermeable subgrade soil. This poses a risk of subsurface erosion and reduces the storage and infiltration capacity of the pavement surface. If required depending upon slope, the subgrade ~~must~~ shall be designed to create subsurface ponding to detain subsurface flow, increase infiltration, and reduce structural problems associated with subgrade erosion on slopes (refer to Figure ~~5.185-16~~ in *Section 5.4.6*). In such cases, ponding shall be provided using periodic lateral subsurface barriers (e.g., check dams) oriented perpendicular to the subgrade slope. While the frequency of the check dams is calculated based on the required subsurface ponding depth and the subgrade slope, typical designs include barriers at least every 3 inches of grade loss.

Minimum requirements associated with lateral subsurface barriers include the following:

- Permeable pavement surfaces with subgrade slopes greater than 5 percent shall include subsurface check dams to reduce structural problems associated with subgrade erosion on slopes, unless a geotechnical evaluation of subgrade soils shows that check dams are unnecessary for erosion control.
- Subsurface check dams shall be impermeable and restrict lateral flow along the top of the subgrade soil.
- The check dams shall not extend to the elevation of the surrounding ground.

Design of Underdrained Surfaces to be Equivalent to Permeable Pavement Surfaces

Areas with underdrains, such as athletic fields, play areas, synthetic turf yards, etc., are hard surfaces per the definitions of “impervious surface” and “hard surface” in Appendix A of this Stormwater Manual. However, they can be designed to act equivalently to a permeable pavement surface if they meet all of the design criteria for permeable pavement surfaces and the following criteria are met:

- The 3-inch minimum aggregate subbase for the entire underdrained area is located below the lowest underdrain or subsurface check dams are added to ensure at least 3 inches of subsurface ponding will occur across the entire underdrained area. Note that additional aggregate depth may be needed for constructability and placement of the subbase material (due to size of rock in the subbase), for structural design support, or for stormwater storage.

- [The materials above and below the subbase aggregate are free-draining and no impermeable liners are used.](#)

5.6.2.6. BMP Sizing

Sizing for On-site List Approach

Permeable pavement surfaces shall be selected to meet the On-site List Requirement (refer to *Section 3.3.1* and *Appendix C* for infeasibility criteria). The area of permeable pavement surface meets the requirement.

Pre-sized Approach for Flow Control

The Pre-sized Approach may be used for projects with new and replaced hard surface areas up to 10,000 square feet. Under the Pre-sized Approach (refer to *Section 4.1.2*), pre-sized permeable pavement surfaces receive credits toward meeting the Pre-developed Pasture and Peak Control Standards. Credits for permeable pavement surfaces are provided in [Table 5-345.36](#), organized by performance standard and subgrade slope. These credits can be applied to reduce the hard surface area requiring flow control. If partial credit (less than 100 percent) is received, the standard is not completely achieved and additional measures will be required. As an example, for a site subject to the Peak Control Standard, a permeable pavement surface on subgrade with a slope exceeding 2 percent would receive a 71 percent credit. Therefore, 71 percent of the permeable pavement surface can be excluded from drainage calculations. The impervious area (the area used to size the downstream flow control facility) would be calculated as 29 percent of the permeable pavement surface area.

Table 5-345.36. Pre-Sized Flow Control Credits for Permeable Pavement Surfaces with and without Check Dams.

	Subgrade Slope	Credit (%)		
		Pre-developed Pasture Standard	Peak Control Standard	Water Quality Treatment Standard ^a
Without Check Dams	Up to 2%	25% 100%	7% 96% ^b	88% 100%
	>2%	0%99%	0%71%	6%100%
With Check Dams	Up to 2%	100%	63%	100%
	>2%	99%	68%	100%

Impervious Area Managed = Permeable Pavement Surface Area x Credit (%) / 100.

^a Pre-sized Approach may be used to meet basic water quality treatment. Enhanced water quality treatment may be achieved if soil suitability criteria are met (refer to *Section 4.5.2*).

^b ~~Permeable pavement surface meets the peak flow standard (i.e., achieves a 100% credit) if the aggregate subbase depth is increased to 3.5 inches.~~

To use these flow control credits to meet flow control standards, the BMP shall meet the general requirements for permeable pavement surfaces outlined in this section plus the following specific requirements:

- The aggregate subbase shall be at least 3 inches in depth.
- Subgrade slope shall be as specified in the table.

- To meet water quality treatment, the underlying soil shall meet the treatment soil requirements outlined in *Section 4.5.2* or a water quality treatment course shall be used.
- No underdrain or [low-permeability liner](#) or impermeable liner may be used.

For subgrade slopes exceeding 2 percent, flow control performance is lower. For improved performance, the surface may be designed as a permeable pavement facility with subsurface ponding and/or increased aggregate subbase depth. In this case, the surface shall be evaluated as a permeable pavement facility (refer to *Section 5.4.6*).

Alternatively, the performance of permeable pavement surfaces can be evaluated using a continuous simulation hydrologic model as described below.

Modeling Approach for On-site Performance Standard, Flow Control, and Water Quality Treatment

The approved continuous simulation hydrologic modeling methods for permeable pavement surfaces vary as shown in Table [5-355.37](#). ~~Depending upon the slope of the underlying subgrade and whether or not the aggregate subbase is below the surrounding grade, surfaces may be modeled explicitly (refer to Table 5.36) or with a land cover approximation (refer to Table 5.37).~~

For flat and low slope permeable pavement surface installations (0 to 2 percent) with subgrade below the surrounding grade, the aggregate subbase depth may be iteratively sized until the performance standard(s) are met. For other scenarios, partial credit towards meeting standards can be achieved and runoff from the pavement area can be routed to a downstream BMP.

Table [5-355.37](#). Modeling Methods for Permeable Pavement Surfaces.

Subbase	Wearing Course	Subgrade Slope	Modeling Representation	Performance
Subbase below (or partially below) the surrounding grade without internal dams within the base materials	Any	0–2%	Model subbase storage and infiltration into underlying soil explicitly. The aggregate subbase depth should be set at the depth of the aggregate below the surrounding grade. Refer to Table 5.38-5.36 .	The aggregate subbase depth may be sized to meet performance standards.
			Represent surface with land cover approximation. Refer to Table 5.37.	Partial credit towards performance standard may be achieved.
		>2%	Model subbase storage and infiltration into underlying soil explicitly with nominal ponding depth of 0.5-inch infiltration rate and a total effective depth of 1 inch. The dimensions of the simulated permeable pavement shall be equal to the below grade base materials. If required for simulation, an overflow riser shall have a height of 0.5 inch and a diameter of 1,000 inches (to ensure there is minimal head on the riser). Refer to Table 5.38-5.36 .	Partial credit towards performance standard may be achieved. To fully meet performance standards on sloped subgrade, use permeable pavement facility (refer to <i>Section 5.4.6</i>).

			Represent surface with land cover approximation. Refer to Table 5.37.	
Subbase below (or partially below) the surrounding grade with internal check dams within the base material Subbase above surrounding grade	Any Perous Asphalt or Pervious Concrete	Any	Model subbase storage and infiltration into underlying soil explicitly. Model each cell of permeable pavement that is separated by internal dams separately as a gravel-filled trench. The dimensions of each simulated cell shall be equal to the below grade base materials with a storage depth equal to the average depth of water behind the downstream check dam. If required for simulation, an overflow riser shall have a height equal to the storage depth and a diameter of 1,000 inches (to ensure there is minimal head on the riser). Each cell should have an appropriate tributary drainage area equal to the permeable pavement area above. Refer to Table 5.38. Represent surface with land cover approximation. Refer to Table 5.37.	Partial credit towards performance standard may be achieved.
	Grid System	Any	Represent surface with land cover approximation. Refer to Table 5.37.	Partial credit towards performance standard may be achieved.
	Permeable Paver	Any	Represent surface with land cover approximation. Refer to Table 5.37.	Partial credit towards performance standard may be achieved.

Table 5-365.38. Continuous Modeling Assumptions for Permeable Pavement Surface (Explicit Representation).

Variable	Assumption
Precipitation Series	Seattle 158-year, 5-minute series
Computational Time Step	5 minutes
HSPF Parameters	LSUR, SLSUR, NSUR shall be adjusted per Appendix F
Permeable Pavement Surface	Option 1: WWHM and MGSFlood have an element The selected model may have a routine specifically developed for permeable pavement that simulates precipitation falling on the pavement, infiltration through the pavement section, storage in the aggregate beneath the pavement, and infiltration into the underlying soil. Option 2: If a permeable pavement element routine is not available, represent the permeable pavement area as an impervious basin with runoff routed to a gravel-filled trench (of the same size as the permeable pavement area) with infiltration to underlying soil. The gravel-filled trench represents the pavement’s underlying aggregate layer. Refer to See Table 5-255.27 “Permeable Pavement Facility and Contributing Area” row for guidance on modeling run-on from other contributing drainage areas. Additional areas draining to permeable pavement surfaces are limited to 10% of the permeable pavement area.
Precipitation Applied to Surface	If using Option 1, precipitation is applied to the pavement area. If using Option 2, do not apply precipitation to the trench bed because precipitation is already applied to basin before routing to trench.
Evaporation Applied to Surface	If using Option 1, evaporation is applied to the pavement area.

	If using Option 2, evaporation is applied to the impervious basin before routing to the trench.
Aggregate Subbase Depth	When the subgrade slope is 0 to 2%, use the depth of the aggregate subbase below surrounding grade. When the subgrade slope exceeds 2%, use a total effective nominal depth of 1 inch. <u>0.5-inch.</u>
Aggregate Subbase Porosity	Assume maximum 25% unless test <u>result</u> is provided showing higher porosity (up to 35%) for aggregate compacted and in place.
Subgrade Soil Design Infiltration Rate	Design infiltration rate (<i>Section 4.5.2, Appendix D</i>)
Infiltration Across Wetted Surface Area	No (infiltration on bottom area only)
Outlet Structure	Unless the selected model represents surface sheet flow when pavement section is saturated, the overflow can be simulated as overtopping an overflow riser. Overflow riser elevation is set at average maximum subsurface ponding depth. Flow may be modeled as weir flow over riser edge. Freeboard modeled within the storage reservoir shall be sufficient to allow the water surface elevation to rise above the weir or overflow pipe elevation to provide head for discharge.

5.6.2.7. Minimum Construction Requirements

The construction specifications and criteria for permeable pavement surfaces are the same as those presented for permeable pavement facilities (refer to *Section 5.4.6.7*).

5.6.2.8. Operations and Maintenance Requirements

Permeable pavement O&M requirements are the same as those presented for permeable pavement facilities in *Appendix G (BMP No. 2625)*.

~~Table 5.37. Continuous Modeling Assumptions for Permeable Pavement Surface (Land Cover Approximation).~~

Variable	Assumption
Precipitation Series	Seattle 158-year, 5-minute series
Computational Time Step	5 minutes
Basin	Model surface area as land cover approximation: Perous Asphalt or Pervious Concrete: lawn on underlying soil type (till or outwash) Grid System: lawn on underlying soil type (till or outwash) Permeable Paver: 50% lawn on underlying soil type (till or outwash) and 50% impervious

5.7. Detention BMPs

Detention facilities provide for the temporary storage of stormwater runoff. Stormwater is then released through a control structure at an attenuated rate to meet flow control performance standards. The BMPs in this section include:

- Detention ponds
- Detention pipes
- Detention vaults/[chambers](#)
- Detention cisterns
- Other detention options

5.7.1. Detention Ponds

5.7.1.1. Description

Detention ponds are basins that temporarily store runoff and control release rates. Detention ponds may be designed to drain completely between storm events, or designed as a combination water quality treatment and flow control facility. The combination of water quality treatment and flow control functions is summarized in *Section 5.8.9*.

5.7.1.2. Performance Mechanisms

Detention ponds provide peak flow attenuation by slowly releasing low flows through an outlet control structure.

5.7.1.3. Applicability

Detention ponds can be applied to meet or partially meet the requirements listed below.

BMP	On-site		Flow Control			Water Quality			Conveyance	
	List	Standard	Forest	Pasture	Peak	Basic	Enhanced	Oil Control		Phosphorus
Detention Pond		✓ ^a	✓	✓	✓					✓

^a Standard may be partially achieved for smaller contributing areas.

5.7.1.4. Site Considerations

Detention ponds require a large amount of area. In addition to the area required for the pond, maintenance access shall be provided, which can affect the footprint of the pond and in part determine whether they are feasible for a particular site. In a highly developed area like the City of Seattle, large open ponds are somewhat uncommon.

Setback requirements for detention ponds are intended to protect neighboring properties from flooding and protect receiving waters and critical areas from water quality impacts. Refer to Volume V of the SWMMWW for detention pond setback requirements. The following additional setback requirements also apply to detention ponds installed within the City limits:

- A minimum 5-foot setback is required from the toe of the exterior slope to the property line.
- A minimum 5-foot setback is required from the emergency overflow water surface to the property line.
- Geotechnical analysis is required for facilities within 20 feet of any structure or property line or within 50 feet up-slope of a structure when the slope between the top of the pond and the structure is greater than 15 percent.
- Detention ponds are not allowed within steep slopes, known landslide areas, and their 15-foot buffers as defined by the regulations for ECAs (SMC, Section 25.09.012). For

[detention ponds within a setback equal to the height of the slope to a maximum of 50 feet from the top of steep slope and known landslide area, a slope stability assessment shall be completed by a licensed geotechnical engineer or engineering geologist considering the effects on slope stability due to a leaking or damaged detention BMP.](#)

5.7.1.5. Design Criteria

The design criteria in this section are for detention ponds. However, many of the criteria also apply to infiltration basins (*Section 5.4.8*), as well as wet ponds and combined detention/wet pools (*Section 5.8.9*).

The following provides a description and requirements for the components of detention ponds. Some or all of the components may be used for a given application depending on the site characteristics and restrictions, pollutant loading, and design objectives. Design criteria are provided in this section or in Volume [V#](#) of the SWMMWW for the following elements:

Design Element	SWMMWW Design Criteria	Seattle-specific Design Criteria
Detention pond geometry	✓	✓
Access to cells for maintenance	✓	✓
Fencing	✓	✓
Embankments and failure analysis	✓	✓
Dam safety	✓	✓
Vegetation and landscaping	✓	✓
Design and construction of access roads	✓	
Primary overflow	✓	
Emergency overflow spillway	✓	

Refer to Detention Ponds in Volume [V#](#) of the SWMMWW for specific detention pond design criteria. The City’s design criteria for specific design elements are summarized below.

Detention Pond Geometry

Refer to Detention Ponds in Volume [V#](#) of the SWMMWW for detention pond design considerations. The following additional requirements shall be followed for detention ponds installed in Seattle:

- Vertical retaining walls and fencing shall be used for areas of the pond designed for sediment removal by Vactor.
- Any pond cell allowing or requiring entry for maintenance, including vegetation maintenance, shall have a section of interior side slopes of 4H:1V for safe egress.

Access to Cells for Maintenance

Refer to Detention Ponds in Volume [V#](#) of the SWMMWW for access design considerations. The following additional requirement shall be followed for detention ponds installed in Seattle:

- An access plan is required for sediment removal from all cells. ~~Early conversation with SPU is encouraged and Director's approval is required.~~

Fencing

Refer to Detention Ponds in Volume [V#](#) of the SWMMWW for fencing considerations. Fencing requirements will depend on the specific site and possibly on land use requirements. ~~Early conversation with SPU and SDCI about Safety and Public Access is encouraged and Director's approval is required.~~ Fencing and gates will be evaluated as part of planning for access for maintenance in addition to public access or exclusion planning.

Embankments and Failure Analysis

Refer to Detention Ponds in Volume [V#](#) of the SWMMWW for embankment design requirements. The following additional requirements shall be followed for detention ponds installed in Seattle:

- If an embankment is proposed to impound water, early conversations with SPU and SDCI are encouraged ~~and Director's approval is required.~~ Impoundment of a water volume exceeding 10 acre-feet is considered a dam and is regulated by Ecology, and SPU shall be notified. Materials provided to Ecology shall be submitted to SPU upon request.
- A failure analysis describing impacts of embankment failure shall be provided.

Dam Safety

Refer to Detention Ponds in Volume [V#](#) of the SWMMWW for dam safety requirements. The following additional requirement shall be followed for detention ponds installed in Seattle:

- Detention facilities that can impound 10 acre-feet or more with the water level at the embankment crest shall meet the state's dam safety requirements, even if water storage is intermittent and infrequent (WAC 173-175-020(1)).

Ecology contact information and electronic versions of the guidance documents in PDF format are available on the Ecology website at (<https://ecology.wa.gov/Water-Shorelines/Water-supply/Dams>~~www.ecy.wa.gov/programs/wr/dams/dss.html~~).

Vegetation and Landscaping

Refer to Detention Ponds in Volume [V#](#) of the SWMMWW for vegetation and landscaping requirements. The following additional requirements shall be followed for detention ponds installed in Seattle:

- A plan for landscape establishment is required. Consider installation of a hose bib and water service for watering.
- All planted slopes shall be accessible for vegetation maintenance.
- Use of ornamental plantings in the vicinity of a detention pond are discouraged and may not be allowed to due concerns regarding seed transport.

5.7.1.6. BMP Sizing

Refer to Detention Ponds in Volume [VIII](#) of the SWMMWW for BMP Sizing considerations.

5.7.1.7. Minimum Construction Requirements

The following construction requirements should be considered during construction of a detention pond:

- Detention ponds may be used for sediment control during site construction, but sediment shall be removed upon completion.
- Exposed earth on the pond bottom and interior side slopes shall be vegetated or seeded with an appropriate seed mixture.

5.7.1.8. Operations and Maintenance Requirements

Detention pond O&M requirements are provided in *Appendix G (BMP No. 1)*.

5.7.2. Detention Pipes

5.7.2.1. Description

Detention pipes are underground storage facilities for stormwater. Detention pipes can be combined with rainwater harvesting (refer to *Section 5.5.1*).

5.7.2.2. Performance Mechanisms

Detention pipes provide peak flow attenuation by slowly releasing low flows through an orifice.

5.7.2.3. Applicability

Detention pipes can be applied to meet or partially meet the requirements listed below.

BMP	On-site		Flow Control			Water Quality				Conveyance
	List	Standard	Forest	Pasture	Peak	Basic	Enhanced	Oil Control	Phosphorus	
Detention Pipe		✓ ^a	✓ ^b	✓ ^b	✓ ^b					✓

^a Standard may be partially achieved for smaller contributing areas.

^b Standard may be partially or completely achieved depending upon contributing area and minimum orifice size.

5.7.2.4. Site Considerations

The primary site considerations for detention pipes include conflicts with existing underground utilities, [building foundation and steep slopes and landslide prone areas](#). While there are no specific setback requirements for detention pipes [from buildings](#), detention pipe location and pipe material approval is required and may require geotechnical analysis.

[Detention pipes are not allowed within steep slopes, known landslide areas, and their 15-foot buffers as defined by the regulations for ECAs \(SMC, Section 25.09.012\). For detention pipes within a setback equal to the height of the slope to a maximum of 50 feet from the top of steep slope and known landslide area, a slope stability assessment shall be completed by a licensed geotechnical engineer or engineering geologist considering the effects on slope stability due to a leaking or damaged detention BMP. More stringent watertightness/exfiltration field testing of detention pipes within a 50-foot setback from the top of the steep slope and known landslide area may be required.](#)

[Additionally, pipe systems that do not provide a watertight seal \(e.g., CMP pipe\) are not allowed within 200 feet from the top of an ECA steep slope, landslide prone area, or known landslide area or under buildings or other structures.](#)

Grading and drainage collection on the site are important site considerations that can impact flow control effectiveness. Special care may be necessary, particularly with roadway projects, to match BMP sizing to actual runoff collected and conveyed to the facility.

5.7.2.5. *Design Criteria*

The following provides a description and requirements for the components of detention pipes. [Components of a typical private property detention pipe are shown in Figure 5.26.](#) Some or all of the components may be used for a given application depending on the site characteristics and restrictions and design objectives. Design criteria are provided in this section for the following elements:

- Materials
- Pipe bedding
- Structural stability
- Access

Detention Pipe Materials and Bedding

The material, diameter, and specification of the detention pipe shall be indicated on the [Side Sewer Permit application, drainage plans](#) required before installing the drainage facility. Typical design requirements for detention pipes are shown in City of Seattle Standard Plan No. 270 through 272 and provided in the City of Seattle Side Sewer Directors' Rule, which can be found on SDCI's website (www.seattle.gov/sdci~~www.seattle.gov/dpd~~). [Proposals for alternate materials, or alternate bulkhead designs shall be submitted with loading calculations.](#)

Refer to [City of Seattle Standard Plan No. 272 and Appendix E](#) for flow control structure details.

~~The City has developed the following requirements for pipe bedding:~~

All detention pipe bedding installed on public property shall be per the City of Seattle Standard Specifications for Road, Bridge and Municipal Construction.

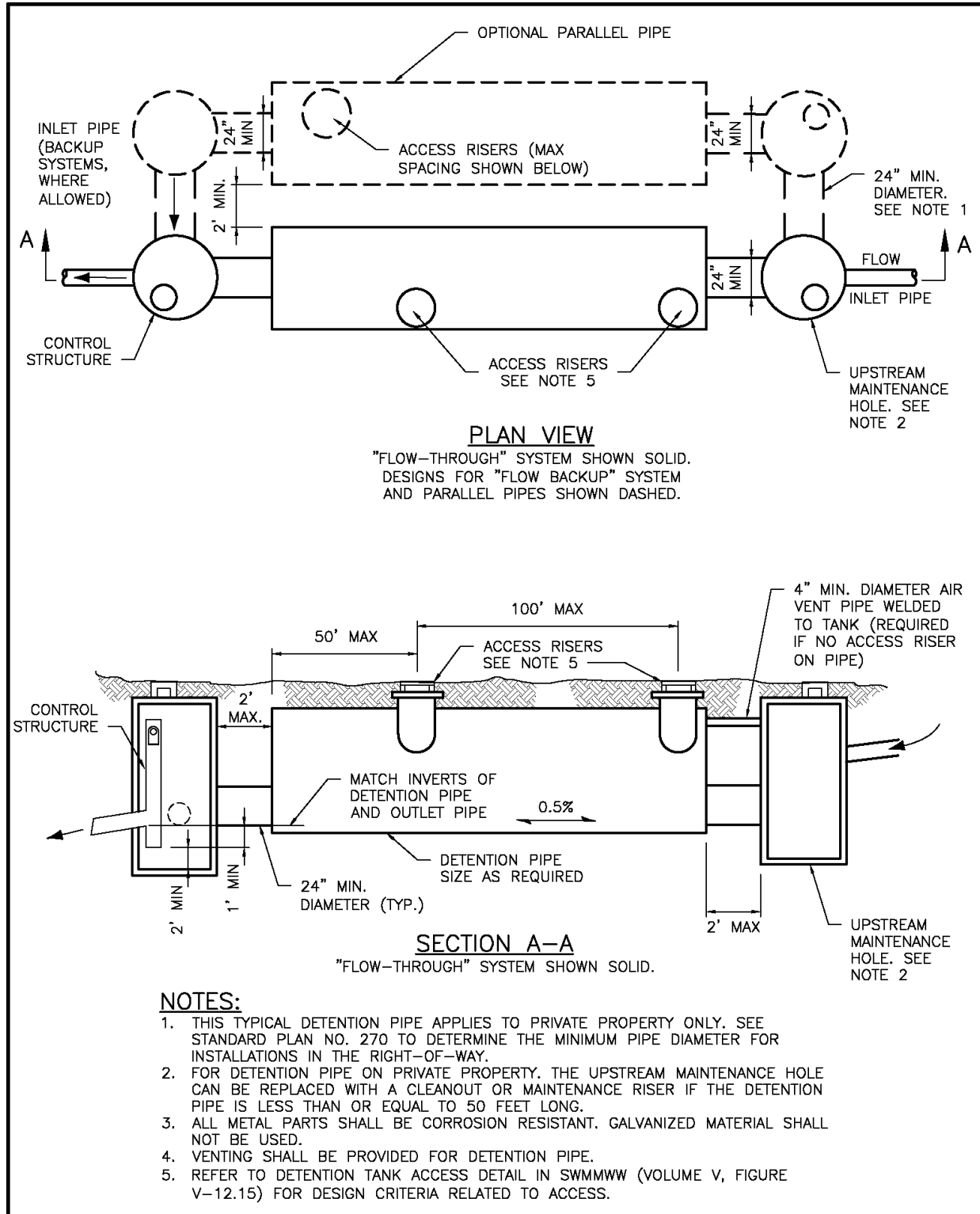

Figure 5.26. Typical Private Property Detention Pipe.

Structural Stability

The following structural requirements apply to detention pipes:

- Detention pipes shall meet structural requirements for overburden support, buoyancy, and traffic loading as appropriate.
- [Detention pipes and associated structures shall be watertight and the finished detention pipe system shall be field tested as described in Section 5.7.2.7.](#)
- When a detention pipe is located under a building, provide a load analysis [and show the detention pipe on the structural plans for the building for structural review in addition to the drainage plans](#). The pipe shall not be located under the foundation or have pressure exerted on it by the foundation. In moderately pervious soils where seasonal groundwater may induce flotation, buoyancy tendencies shall be balanced either by ballasting with backfill or concrete backfill, providing concrete anchors, or increasing the total weight.
- [When corrugated metal pipe is selected, end plates shall be designed for structural stability at maximum hydrostatic loading. Flat end plates generally require thicker gage material than the pipe and/or require reinforcing ribs. Corrugated metal pipe is not allowed for use in the right-of-way, critical areas, geologic hazard areas, or underneath buildings.](#)
- [When an alternate to the City of Seattle Standard Plans is proposed \(including materials, end plates or combination T-top maintenance hole and end plate, or end plate with a smaller pipe connecting to a standard maintenance hole\), the alternate shall be designed for structural stability at maximum hydrostatic loading and to be watertight. Alternates to City of Seattle Standard Plan No. 270 are not allowed for use in the right-of-way.](#)
- Detention pipes shall be placed on a stable, well consolidated foundation, have suitable bedding, and shall follow City of Seattle Standard Specifications for Road, Bridge, and Municipal Construction.
- Detention pipes shall not be placed in fill slopes, unless a geotechnical analysis is provided for stability and constructability.

Access

[The following access requirements apply to detention pipes in the right-of-way:](#)

- ~~Within the right-of-way~~ [A maintenance hole structure is required at all access points shall be provided](#) as shown on City of Seattle Standard Plan No. 270.
- Truck access is required at each maintenance hole location.

[The following access requirements apply to detention pipes on private property:](#)

- ~~A maintenance structure at all access points per Detention pipes on a parcel have an option to follow~~ City of Seattle Standard Plan No. 270 ~~or 271 shall be used except as follows: or, when using corrugated metal pipe, City of Seattle Standard Plan No. 271 may be used.~~

- [A 36-inch-diameter vertical pipe with ladder and a 24-inch-diameter locking manhole frame and cover per the Detention Tank Access Detail in the SWMMWW \(Volume V, Figure V-12.15\) may be used along pipe spans.](#)
- [Detention pipes less than 50 feet long may substitute a cleanout for the maintenance hole at the upstream end.](#)
- [Alternate configurations may be approved only when a plan for cleaning and maintenance access for any equipment and personnel required and for visual inspection by City of Seattle inspection personnel has been prepared and submitted for review.](#)

In addition, the following access requirements apply [to both detention pipes in the right-of-way and on private property](#):

- [All detention pipe openings and flow control structures shall be readily accessible for maintenance personnel, maintenance vehicles, and City of Seattle inspection personnel.](#)
- [Multiple detention pipes that are connected to a single flow control structure shall be connected between structures with pipe of a minimum 24-inch diameter. Larger diameter connecting pipe is preferred.](#)
- [Connector pipes for manifolded detention pipes or for the connection between a maintenance hole structures shall be a minimum of 24-inch diameter.](#)
- [All detention pipes more than 50 feet long and all detention pipes in the right-of-way shall provide an upstream maintenance hole for access at both ends of the pipe.](#) ~~Detention pipes less than 50 feet long on private property may substitute a cleanout for the maintenance hole at the upstream end.~~

5.7.2.6. *BMP Sizing*

Pre-sized Approach for Flow Control

The Pre-sized Approach may be used for projects with new and replaced hard surface areas up to 10,000 square feet. Under the Pre-sized Approach (refer to *Section 4.1.2*), pre-sized detention pipes may be used to achieve Pre-developed Pasture and Peak Control Standards. Sizing factors for detention pipe receiving runoff from a hard surface are provided in Table [5-385.39](#). Sizing factors are organized by pipe diameter, contributing area, and flow control standard. To use these sizing factors to meet flow control standards, the facility shall meet the general requirements for detention pipes outlined in this section, plus the following specific requirements:

- Sizing equations are applicable for contributing areas between 2,000 and 10,000 square feet.
- Pipe length shall be sized using the applicable sizing equation.
- The low flow orifice diameter shall be 0.5 inch.
- Detention pipe shall be the designated diameter (24 or 36 inches). For intermediate diameters (between 24 and 36 inches), the pipe length may be linearly interpolated.

- The entire volume of the pipe shall be available for storage (overflow riser shall be set equal to the crown of the pipe).

The pipe length is calculated as a function of the hard surface area routed to it. As an example, for the Pre-developed Pasture Standard, the pipe length for a 24-inch-diameter pipe receiving runoff from between 2,000 to 10,000 square feet of hard surface would be calculated as:

$$0.0571 \times \text{contributing hard surface area (square feet)} + 49.5 \text{ feet}$$

All area values shall be in square feet and length values shall be in feet. Alternatively, detention pipes for small sites can be sized using a continuous model as described in the subsequent section.

Table 5-395.39. Pre-sized Sizing Equations for Detention Pipe.

Detention Pipe Diameter ^a	Contributing Area	Sizing Equation for Pipe Length			
		Pre-developed Pasture Standard	Pre-Developed Pasture Standard Orifice Diameter for Construction	Peak Control Standard	Peak Control Standard Orifice Diameter for Construction
24 inches	2,000 – 495,000 sf	[0.0571 x A] + 49.5	0.5	[0.0475 x A] + 270.00014 x [A ^{1.69}]	0.5
	5,001 – 6,000 sf				0.625
	6,001 – 8,500 sf				0.75
	8,501 – 10,000 sf				0.75
36 inches	2,000 – 495,000 sf	[0.0733 x A] - 220.95 [0.0257 x A] + 21.8	0.5	[0.0236 x A] + 6.750.000196 x [A ^{1.55}]	0.5
	5,001 – 7,000 sf				0.625
	7,001 – 10,000 sf				0.625

A – contributing hard surface area; ft – feet; sf – square feet.

For Peak Control Standard: Pipe Length (ft) = Factor x [A (sf) ^ Integer].

Hard Surface Area Managed (sf) = [Pipe Length (ft) ÷ Factor] ^ (1 ÷ Integer).

For Pre-developed Pasture Standard: Pipe Length (ft) = [Factor x A (sf)] + Integer.

Hard Surface Area Managed (sf) = [Pipe Length (ft) - Integer] ÷ Factor.

^a Detention pipe diameter refers to live storage depth (i.e., does not include freeboard or sediment storage requirements).

Modeling Approach for On-site Performance Standard and Flow Control

When using the continuous runoff model for pipe sizing, the assumptions listed in Table 5-395.40 shall be applied. It is recommended that pipes be modeled as horizontal cylinders with an outlet structure that includes a low flow orifice. The contributing area, pipe diameter, pipe length and orifice configuration should be iteratively sized until the Minimum Requirements for Flow Control are met (refer to *Volume 1, Section 5.3*).

For smaller contributing areas, the minimum diameter for the low flow orifice (0.5 inch) will be too large to meet standard release rates, even with minimal head. Refer to *Section 4.1.3.2* for contributing area thresholds and an alternative modeling approach for smaller contributing areas. The designer is advised to evaluate other detention BMPs, including vaults, since the required pipe slope, minimum orifice size, and contributing area may make

the detention pipe BMP impractical. Evaluation of a detention pipe diameter less than 18 inches is not advised. Refer to *Section 4.1.3.2* for additional flow control modeling guidance.

Table 5.395.40. Continuous Modeling Assumptions for Detention Pipe.

Variable	Assumption
Precipitation Series	Seattle 158-year, 5-minute series
Computational Time Step	5 minutes
HSPF Parameters	LSUR, SLSUR, NSUR shall be adjusted per Appendix E
Inflows to Facility	Surface flow and interflow from total drainage area (including impervious and pervious contributing areas) be connected to the facility.
Precipitation and Evaporation Applied to Facility	No
Infiltration	No
Total Depth	The total depth is the pipe diameter (i.e., live storage depth)-
Outlet Structure	Low flow orifice, riser height and diameter
Low Flow Orifice	Minimum diameter of 0.5 inch, set 1 foot below the pipe invert-

5.7.2.7. *Minimum Construction Requirements*

Construction requirements are as follows:

- Place at least 4 inches of bedding under the pipe. The bedding shall fill the trench to a point half-way up the sides of the pipe (to the “spring line”).
- Provide at least 2 feet of cover over a detention pipe. For single-family and duplex residences, 18 inches of cover is allowable. Before a side sewer permit is signed off as completed, a City inspector shall approve the installed system, including the detention pipe and the flow control structure, after it is bedded but before it is covered with soil.
- [The standard slope for detention pipes is 0.5 percent. The inlet pipe to the detention pipe and the outlet pipe from the flow control structure shall have at least a 2 percent slope, the same as required for other service drain pipes.](#)
- [Detention pipe systems shall be field tested for exfiltration \(i.e., watertightness\) as follows:](#)
 - [Plug the inlets and outlet and fill the system to one-half the distance from the outlet invert to the top of the riser on the outlet structure.](#)
 - [The maximum allowable leakage shall not exceed one percent of the volume over a 24-hour period](#)
- Field changes to the flow control device assembly, including elevation changes, require submittal to the Engineer of Record for confirmation that the device still meets the design requirements.

5.7.2.8. *Operations and Maintenance Requirements*

Detention pipe O&M requirements are provided in *Appendix G (BMP No. 3)*.

Alternate configuration of detention pipes shall document a plan for cleaning and maintenance access for any equipment and personnel required.

5.7.3. *Detention Vaults/Chambers*

5.7.3.1. *Description*

Detention vaults/[chambers](#) are underground storage facilities for stormwater. Detention vaults/[chambers](#) can be combined with rainwater harvesting (refer to *Section 5.5.1*). [Stackable, modular detention chambers can also be used.](#)

5.7.3.2. *Performance Mechanisms*

Detention vaults/[chambers](#) provide peak flow attenuation by slowly releasing low flows through an orifice.

5.7.3.3. *Applicability*

Detention vaults/[chambers](#) can be applied to meet or partially meet the requirements listed below.

BMP	On-site		Flow Control			Water Quality				Conveyance
	List	Standard	Forest	Pasture	Peak	Basic	Enhanced	Oil Control	Phosphorus	
Detention Vault/ Chamber		✓ ^a	✓ ^b	✓ ^{a, b}	✓ ^b					✓

^a Standard may be partially achieved for smaller contributing areas.

^b Standard may be partially or completely achieved depending upon contributing area and minimum orifice size.

5.7.3.4. *Site Considerations*

Detention vaults/[chambers](#) are typically shallower than detention pipes, since they can utilize a greater area. Primary site considerations for a detention vault/[chambers](#) include providing sufficient access points for maintenance, incorporating the access requirements into a site, conflicts with existing underground utilities, and site setback requirements. While there are no specific setback requirements for detention vaults/[chambers from buildings and utilities](#), detention vault/[chamber](#) location and vault/[chamber](#) material approval is required, and may also require geotechnical analysis.

[Detention vaults/chambers are not allowed within steep slopes, known landslide areas, and their 15-foot buffers as defined by the regulations for ECAs \(SMC, Section 25.09.012\).](#)

[An impermeable liner is required for detention chambers with open bottoms or sides when the facility is within the horizontal setbacks and site constraint areas that are required for infiltrating BMPs per Step 2 of Section 3.2. However, detention facilities that include chambers with open bottoms or sides \(e.g., modular, stackable chambers, open-bottom arch pipe, etc.\) are not allowed within 200 feet from the top of an ECA steep slope, landslide prone area, or known landslide area or under buildings or other structures even if an impermeable liner is provided.](#)

For detention vaults/chambers within a setback equal to the height of the slope to a maximum of 50 feet from the top of steep slope and known landslide area, a slope stability assessment shall be completed by a licensed geotechnical engineer or engineering geologist considering the effects on slope stability due to a leaking or damaged detention BMP. More stringent exfiltration (i.e., watertightness) testing of detention vaults/chambers within a 50-foot setback from the top of the steep slope and known landslide area may be required.

Grading and drainage collection on site are important site considerations that can impact flow control effectiveness. Special care is necessary, particularly with roadway projects, to match BMP sizing to actual runoff collected and conveyed to the facility.

5.7.3.5. Design Criteria

The following provides a description and requirements for the components of [standard](#) detention vaults (Figure [5.275-22](#)) and [stackable, modular detention chambers](#). Flow control structure details are outlined in *Appendix E*. Some or all of the components may be used for a given application depending on the site characteristics and restrictions, pollutant loading, and design objectives.

Standard Detention Vaults

Design criteria are provided in this section for the following elements [of a detention vault](#):

- [Materials](#)
- [Sediment storage](#)
- Structural stability
- Access

Design criteria are summarized below for each of these design elements.

Materials

Minimum 3,000 psi structural reinforced concrete shall be used for detention vaults. All construction joints shall be provided with water stops.

Sediment/Oil Storage

Elevate the invert elevation of the outlet above the bottom of the vault to provide an average of 6 inches of sediment storage over the entire bottom. Also, elevate the outlet a minimum of 2 feet above the orifice to retain oil within the vault. The sediment storage requirement can also be addressed by deepening the forebay at the inlet with a dead storage volume equal to 10 percent of the live volume or an equivalent volume to the 6-inch-deep average sediment storage, whichever is greater.

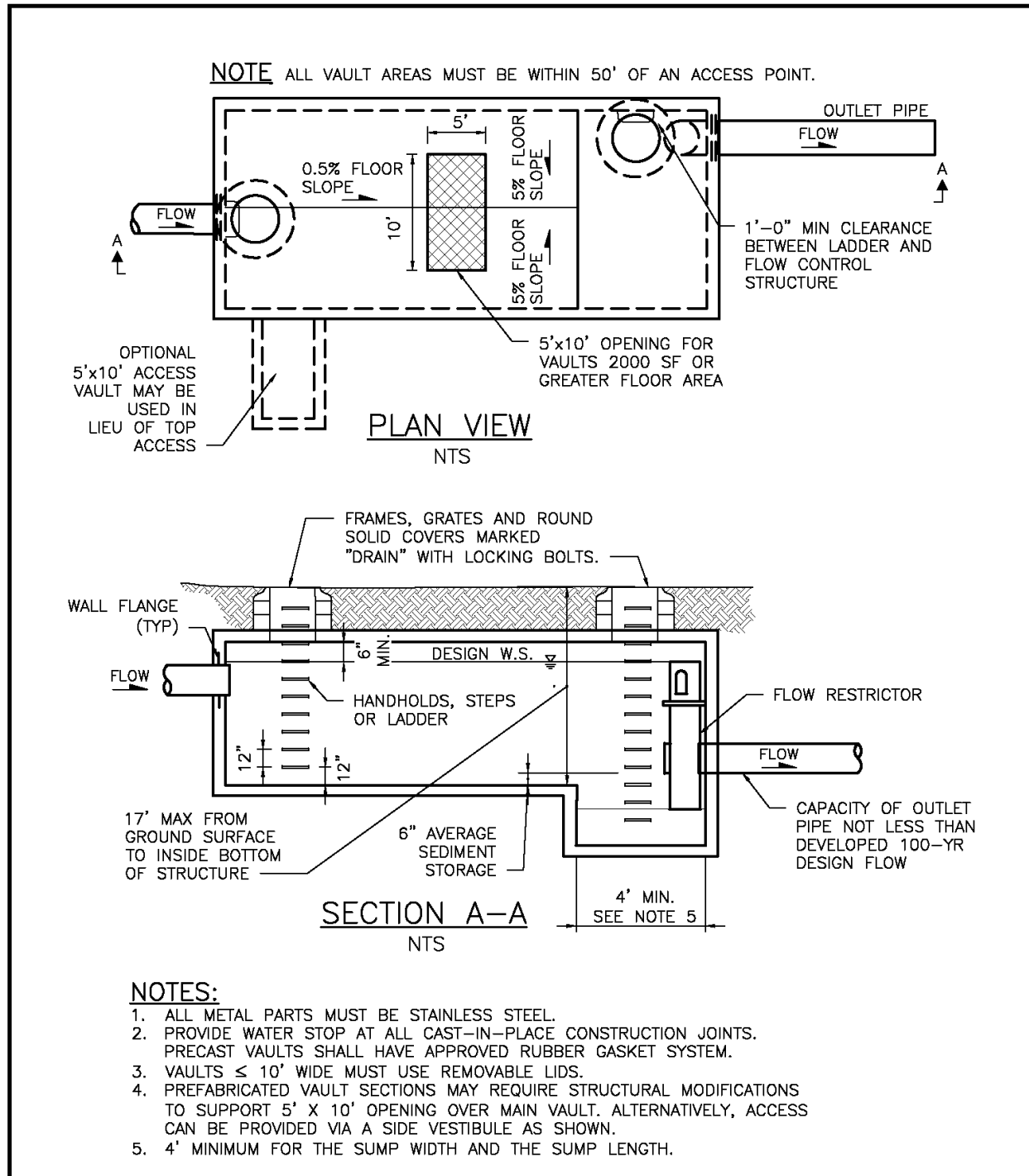

Figure 5.275-22. Typical Detention Vault.

Structural Stability

The following structural requirements apply to detention vaults:

- Detention vaults shall meet structural requirements for overburden support, buoyancy, and traffic loading as appropriate. [Provide a load analysis and submit structural plans for review.](#)
- ~~Design of d~~ Detention vaults shall be watertight [and shall be field tested as described in Section 5.7.3.7.](#)
- When detention vaults are incorporated into or underneath a building, they shall meet all structural requirements for the building or demonstrate no structural interaction, including no loading on the vault from the building foundation.
- Detention vaults shall be placed on a stable, well-consolidated foundation and bedding material.
- Detention vaults shall not be placed in fill slopes, unless a geotechnical analysis for stability and constructability is provided.

Detention pipe is preferred over detention vaults for the public drainage system. Early conversations with SPU are encouraged if considering installation of a detention vault in the right-of-way.

Access

The following access requirements apply to detention vaults:

- Access shall be provided for visual inspection of the flow control structure and for cleaning the entire floor area of the detention vault. A plan for access, including maintenance equipment access is required.
- Access may be provided by use of removable panels, hatches, or ring and cover. For any detention vault requiring entry for maintenance, ladders shall be installed so that the egress path does not exceed 25 feet.
- All access shall be readily accessible by maintenance vehicles, including structures located under buildings.
- The maximum depth from finished grade to the detention vault invert is 17 feet.
- Access shall be provided over both the inlet pipe and outlet structure. Access openings shall be positioned a maximum of 50 feet from any location within the detention vault. Additional access points may be needed on large vaults. Vaults ~~must~~ [shall](#) be designed to slope at least 5 percent from each side towards the center, forming a broad “v” to facilitate sediment removal. If more than one “v” is provided in the vault floor to minimize vault depth, access to each “v” shall be provided. [The sloping floor may not extend into the live volume section of the detention vault.](#)
- Internal structural walls of large vaults shall be provided with openings sufficient for maintenance access between cells. The openings shall be sized and situated to allow access to the maintenance “v” in the vault floor.

Detention Chambers

Follow detention vault design criteria, except for access. For access requirements, refer to detention pipes (Section 5.7.2.5). For connections between chambers, use a 24-inch minimum pipe. Detention chambers shall also include air vents.

Stackable, Modular Detention Chambers

Design criteria are provided in this section for the following elements of a stackable, modular detention chamber:

- Flow entrance and presettling
- Sediment storage
- Chamber materials and layout
- Chamber bedding
- Liner
- Structural stability
- Observation/maintenance port

Design criteria are summarized below for each of these design elements.

Flow Entrance and Presettling

Inflow pipe or a manifold system shall be connected to each stackable, modular detention chamber. Stormwater inflows shall be routed through a catch basin or similar structure with a 2-foot-deep minimum sump and a downturned elbow (trap) before entering the BMP. The volume of the sump shall be equal to the volume of a catch basin required by the current Director's Rules for side sewers. Presettling requirements are provided in Section 4.4.5.

Sediment Storage

Stackable, modular detention chambers shall have 6 inches of dead storage for sediment. This sediment storage requirement can also be addressed by deepening the forebay at the inlet with an equivalent dead storage volume. The sediment storage shall be within the open chamber above the aggregate bedding and liner.

Chamber Materials and Layout

Stackable, modular detention chambers can be constructed of a variety of different materials (i.e., plastic, concrete, aluminum, steel) and shapes (i.e., arch, box). Chamber spacing and depth of cover shall be per the manufacturer's requirements.

Chamber Bedding

Stackable, modular detention chamber bedding is specified by the manufacturer. Minimum bedding shall be from 6-inches below the chamber to an elevation one half the height of the chamber on the outside of the chamber. Chambers shall be bedded with uniformly-graded, washed gravel with a nominal size from 0.75- to 1.5-inch diameter. The minimum void volume shall be 30 percent. These requirements can be met with City of Seattle Mineral Aggregate Type 4.

Liner

A low permeability liner or an impermeable liner shall be placed at the bottom and sides of a stackable, modular detention chamber where the chamber abuts soil or other in situ material. An impermeable liner is required if the facility is within the horizontal setbacks and site constraint areas that are required for infiltrating BMPs per Step 2 of Section 3.2. Refer to the liner specifications in Appendix E.

Structural Stability

The following structural requirements apply to stackable, modular detention chambers:

- Chambers shall meet structural requirements for overburden support, buoyancy, and traffic loading as appropriate. Provide a load analysis and submit structural plans for review.
- Chambers shall be watertight and shall be field tested as described in Section 5.7.3.7.
- Chambers are not allowed to be incorporated into or underneath a building.
- Chambers shall be placed on a stable, well-consolidated foundation and bedding material.
- Chambers shall not be placed in fill slopes, unless a geotechnical analysis for stability and constructability is provided.

Observation/Maintenance Port

Stackable, modular detention chambers shall be equipped with observation/maintenance ports to measure the drawdown time following a storm, to monitor sedimentation to determine maintenance needs, and to provide access for sediment removal.

Observation/maintenance ports at a 50-foot minimum spacing are required at:

- All inlets
- All outlets
- Any sediment forebay/trap

The observation/maintenance ports shall consist of a 12-inch minimum diameter opening with unobstructed view down to the bottom of the chamber. The ports shall have locking lids. If the port includes a pipe that extends through the chamber, the pipe shall be perforated or slotted pipe and shall include notches or space at the bottom to allow for sediment removal through the pipe.

5.7.3.6. BMP Sizing

Pre-sized Approach for Flow Control

The Pre-sized Approach may be used for projects with new and replaced hard surface areas up to 10,000 square feet. Under the Pre-sized Approach (refer to Section 4.1.2), pre-sized detention vaults may be used to achieve Pre-developed Pasture and Peak Control Standards. Sizing factors were not developed for other detention chamber shapes other than a typical detention vault. Sizing factors for rectangular detention vaults receiving runoff from a hard surfaces are provided in Table 5-405.41. Sizing factors are organized by detention depth,

contributing area, and flow control standard. To use these sizing factors to meet flow control standards, the facility shall meet the general requirements for vaults outlined in this section, plus the following specific requirements:

- Sizing equations are applicable for contributing areas between 2,000 and 10,000 square feet.
- Vault area shall be sized using the applicable sizing equation.
- The low flow orifice diameter shall be 0.5 inch.
- Invert of overflow shall be set at the designated detention (i.e., live storage) depth (3 or 4 feet) above the invert of the low flow orifice. For intermediate depths (between 3 and 4 feet), the vault area may be linearly interpolated.
- The vault shall have vertical walls to the designated overflow height.

Table 5-405.41. Pre-sized Sizing Equations for Detention Vaults.

Detention Depth ^a	Contributing Area	Sizing Equation for Vault Area			
		Pre-developed Pasture Standard	Pre-Developed Pasture Standard Orifice Diameter for Construction	Peak Control Standard	Peak Control Standard Orifice Diameter for Construction
3 feet	2,000 – 35,000 sf	[0.0662 x A] + 38.9	0.5	[0.0525 x A] + 27.25 64 sf 0.00025 x [A ^ 1.62]	0.5
	35,001 – 7,500 10,000 sf				
	7,501 – 10,000 sf				
4 feet	2,000 – 38,000 sf	NA ^b	NA	[0.0365 x A] + 19.16 62 sf 0.0011 x [A ^ 1.41]	0.5
	8,001 10,000 sf				

A – contributing hard surface area; NA – not applicable; sf – square feet.

For Peak Control Standard: Vault Area (sf) = Factor x [A (sf) ^ Integer].

Hard Surface Area Managed (sf) = [Vault Area (sf) ÷ Factor] ^ (1 ÷ Integer).

For Pre-developed Pasture Standard: Vault Area (sf) = [Factor x A (sf)] + Integer.

Hard Surface Area Managed (sf) = [Vault Area (sf) - Integer] ÷ Factor.

^a Detention depth refers to live storage depth (i.e., does not include freeboard or sediment storage requirements).

^b A vault with 4 feet of head above the low flow orifice is not applicable for sites subject to the Pre-developed Pasture Standard because the designer is required to reduce the head to at least 3 feet in an attempt to meet this standard ([refer to see Section 4.1.3.2](#)).

The vault area is calculated as a function of the hard area routed to it. As an example, for the Peak Control Standard, the area for a vault with an overflow invert set at 4.0 feet above the low flow orifice and receiving runoff from between 3,000 and 10,000 square feet of hard surface would be calculated as:

$$0.0011 \times [\text{hard surface area (square feet)} ^ 1.41]$$

All area units shall be in square feet. A [detention](#) vault with 4 feet of head above the low flow orifice is not applicable for sites subject to the Pre-developed Pasture Standard because

the designer is required to reduce the head to 3 feet in an attempt to meet this standard (refer to *Section 4.1.3.2*). To meet the Pre-developed Pasture Standard, a [detention](#) vault with 3 feet of live storage depth shall be used.

Modeling Approach for On-site Performance Standard and Flow Control

When using the continuous runoff model for vault sizing, the assumptions listed in Table [5.415.42](#) shall be applied. It is recommended that [detention](#) vaults/[chambers](#) be modeled as a flat-bottomed detention vault/[chamber](#) or tank with an outlet structure that includes a low flow orifice. The contributing area, detention bottom area, overflow depth and orifice configuration should be iteratively sized until the Minimum Requirements for Flow Control are met (refer to *Volume 1, Section 5.3*).

Table [5.415.42](#). Continuous Modeling Assumptions for Detention Vaults/[Chambers](#).

Variable	Assumption
Precipitation Series	Seattle 158-year, 5-minute series
Computational Time Step	5 minutes
HSPF Parameters	LSUR, SLSUR, NSUR shall be adjusted per Appendix F
Inflows to Facility	Surface flow and interflow from total drainage area (including impervious and pervious contributing areas) connected to the facility
Precipitation and Evaporation Applied to Facility	No
Infiltration	No
Total Depth	Vault height (including freeboard) above the vault bottom (does not include sediment storage)
Outlet Structure	Low flow orifice, riser height and diameter
Low Flow Orifice	Invert of low flow orifice set at a minimum of 6 inches above the bottom of the vault

For smaller contributing areas, the minimum diameter for the low flow orifice (0.5 inch) will be too large to meet standard release rates, even with minimal head. Refer to *Section 4.1.3.2* for contributing area thresholds and an alternative modeling approach for smaller contributing areas. For scenarios where standard(s) cannot be met, the designer is advised to evaluate other BMPs. Evaluation of live storage depth less than 3 feet is not required. Refer to *Section 4.1.3.2* for additional flow control modeling guidance.

5.7.3.7. Minimum Construction Requirements

Refer to the construction-related issues outlined above as part of the design criteria. Additional construction requirements are as follows:

- [Conduct infiltration or exfiltration testing of the Detention vault/chamber shall be field tested for exfiltration \(i.e., watertightness\) as follows:](#)
 - [Plug the inlets and outlet and fill the vault/chamber to one-half the distance from the outlet invert to the top of the riser on the outlet structure.](#)
 - [The maximum allowable leakage shall not exceed one percent of the volume over a 24-hour test period.](#)

- Submit field changes to the flow control device assembly, including elevation changes, to the Engineer of Record for confirmation that the device still meets the design requirements.

5.7.3.8. Operations and Maintenance Requirements

Detention vault/[chamber](#) O&M requirements are provided in *Appendix G (BMP No. 3)*.

[Document a plan for cleaning and maintenance access for any equipment and personnel required for stackable, modular detention chambers.](#)

5.7.4. Detention Cisterns

5.7.4.1. Description

Detention cisterns are tanks used for the capture and detention of stormwater runoff. Runoff from roof downspouts can be routed to cisterns for detention and slow release to an approved point of discharge. Like other detention facilities, cisterns can be used to achieve reductions in peak flows and flow durations.

Detention cisterns can be combined with rainwater harvesting (refer to *Section 5.5.1*).

5.7.4.2. Performance Mechanisms

Detention cisterns provide peak flow attenuation by slowly releasing low flows through an orifice. The flow control performance of a detention cistern is a function of contributing area, storage volume, cistern height, and orifice size.

5.7.4.3. Applicability

Detention cisterns can be applied to meet or partially meet the requirements listed below.

BMP	On-site		Flow Control			Water Quality				Conveyance
	List	Standard	Forest	Pasture	Peak	Basic	Enhanced	Oil Control	Phosphorus	
Detention Cistern		✓	✓ ^a	✓ ^a	✓					✓

^a Standard may be partially or completely achieved depending upon contributing area and minimum orifice size.

5.7.4.4. Site Considerations

Detention cisterns can be used to detain rooftop runoff in any type of new or retrofit development project. Cisterns may be used individually or connected to each other in series for greater detention and storage capacity. Detained stormwater and system overflows may be conveyed to an approved point of discharge or to another BMP such as bioretention.

5.7.4.5. Design Criteria

The following provides recommendations and requirements for the common components of cistern detention systems. A schematic for a typical detention cistern is shown in Figure [5.285-23](#). Design criteria are provided in this section for the following elements:

- Contributing area
- Collection system
- Screen/debris excluder
- Cistern
- Flow control orifice
- Overflow

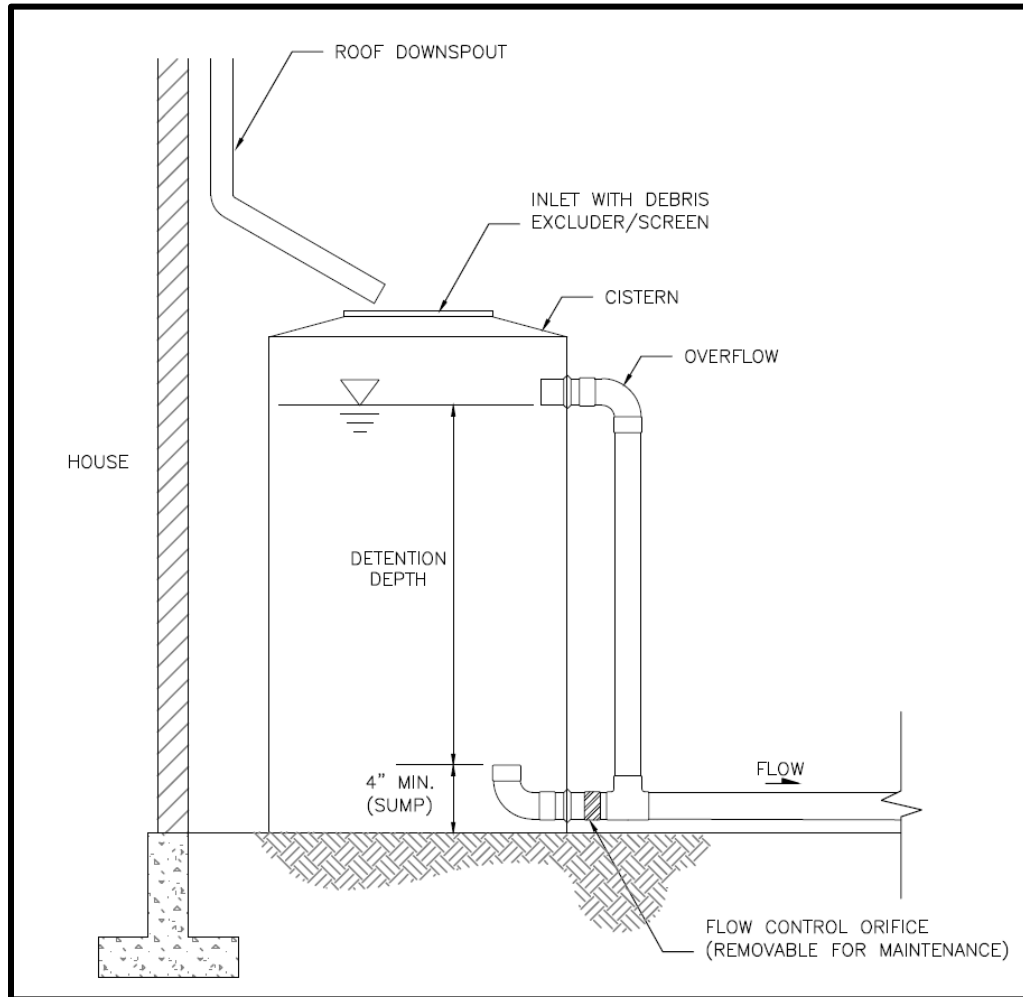

Figure 5.285-23. Detention Cistern.

Contributing Area

The area contributing runoff to a detention cistern shall not be pollution generating (e.g., surfaces subject to vehicular traffic are not acceptable).

To protect the water quality of the rainwater harvested, avoid collecting runoff from roof surfaces composed of materials such as copper or zinc that may release contaminants into the system. Also avoid collecting runoff from roof materials treated with fungicides or herbicides.

Collection System

Collection systems include gutters and downspouts, as well as piping and any other conveyance needed to route runoff from the roof to the cistern.

Screens/Debris Excluder

A filter screen or other debris barrier is required to prevent insects, leaves, and other larger debris from entering the system. A self-cleaning inlet filter is recommended.

Cistern

Cisterns are commonly constructed of fiberglass, polyethylene, concrete, metal, or wood. Tanks can be installed at or below grade, and individually or in series.

Minimum requirements associated with cistern design include the following:

- Detention cisterns are subject to Land Use Code (SMC Title 23) setback requirements.
- All cisterns shall be installed in accordance with manufacturer’s installation instructions.
- Cisterns shall be designed to prevent mosquitoes and other nuisance insects and animals from entering the cistern system. This can be done with tight-fitting covers and appropriate screening at all openings to the cistern.
- Opaque containers shall be used for aboveground cisterns to prevent penetration of sunlight to minimize algal growth.
- Minimum cistern size shall be that of a rain barrel (typically 55 gallons).

Flow Control Orifice

Minimum requirements associated with flow control orifice design include the following:

- As with other detention systems, the minimum diameter shall be 0.25 inch for orifices located above ground, and 0.5 inch for orifices located underground. (Note: belowground facilities are not permitted for single-family residential sites unless approved by the Director.)
- Minimum 4-inch sump shall be provided to protect the orifice from sediment.

Overflow

Cisterns shall have an overflow to convey water exceeding the detention capacity of the system to an approved point of discharge or another BMP (e.g., bioretention area, vegetated cell, or infiltration trench) per *Section 4.3.3*. Conveyance may be provided by gravity flow or by pumps, but gravity flow is preferred.

5.7.4.6. BMP Sizing

Pre-sized Approach for Flow Control

The Pre-sized Approach may be used for projects with new and replaced hard surface areas up to 10,000 square feet. Under the Pre-sized Approach (refer to *Section 4.1.2*), pre-sized detention cisterns may be used to achieve Pre-developed Pasture and Peak Control Standards. Sizing factors for aboveground cisterns receiving runoff from a hard surface are provided in Table 5-425.43. Factors are organized by flow control standard, cistern overflow depth and contributing area. To use these sizing factors and equations to meet flow control standards, the facility shall meet the general requirements for cisterns outlined in this section plus the following specific requirements:

- The cistern area shall be sized using the applicable sizing factor or equation.
- The flow control orifice diameter shall be 0.25 inch.

- The invert of the overflow shall be set at the designated detention (i.e., live storage) depth (3 or 4 feet) above the invert of the flow control orifice. For intermediate depths (between 3 and 4 feet), the cistern area may be linearly interpolated.
- The cistern shall have vertical walls to the designated overflow height.

Table 5-425.43. Pre-Sized Sizing Factors and Equations for Aboveground Detention Cisterns.

Detention Depth ^a	Contributing Area (sf)	Sizing Factor/Equation for Cistern Area				
		Pre-developed Pasture Standard	Pre-Developed Pasture Standard Orifice Diameter for Construction	Peak Control Standard	Peak Control Standard Orifice Diameter for Construction	
3 feet	≤ 2,000	10.6%	0.25	[0.0552 x A] - 2.3435	0.25	
	2,001 – 3,500					5.9%
	3,501 – 5,000	408 sf		0.00036 x A ^{1.68}	0.375	
	5,001 – 10,000 9,999	0.00015 x [A ^{1.74}]			0.5	
	10,000				0.625	
4 feet	≤ 2,000	6.4%	0.25	0.0141 x [A ^{1.1289}]	0.25	
	2,001 – 5,000 3,500					4.1%
	3,501 – 5,000					0.00038 x [A ^{1.63}]
	5,001 – 6,000	322 sf			0.5	
	6,001 – 10,000 9,999	0.0001 x [A ^{1.73}]				0.625
	10,000					

A – contributing hard surface area; sf – square feet.

For Sizing Factors: Cistern Area = Contributing Hard Surface Area x Factor (%)/100.

Hard Surface Area Managed = Cistern Area ÷ Factor (%)/100.

For Linear Equations: Cistern Area (sf) = [Factor x A (sf)] + Integer.

Hard Surface Area Managed (sf) = [Cistern Area (sf) - Integer] ÷ Factor.

For Power Equations: Cistern Area (sf) = Factor x [A (sf) ^ Integer].

Hard Surface Area Managed (sf) = [Cistern Area (sf) ÷ Factor] ^ (1 ÷ Integer).

The cistern bottom area is calculated as a function of the hard surface area routed to it. As an example, to meet the Pre-developed Pasture Standard, the area of a cistern with an overflow invert set at 3 feet above the flow control orifice and receiving runoff from between 5,000 and 10,000 square feet would be calculated as:

$$0.00015 \times \text{contributing hard surface area (square feet)} ^ 1.74$$

All area values shall be in units of square feet. For the same cistern receiving runoff from between 3,500 and 5,000 square feet, the cistern area would be 408 square feet.

Alternatively, cisterns can be sized using a continuous model as described in the next section.

Modeling Approach for On-site Performance Standard and Flow Control

Continuous modeling may be used to size detention cisterns using the procedures presented for detention vaults/[chambers](#) in *Section 5.7.3*. The assumptions provided in [Table 5.41](#)[5.42](#) shall be applied.

5.7.4.7. Minimum Construction Requirements

Refer to the construction-related issues outlined above as part of the design criteria. An additional construction requirement is as follows:

- Submit field changes to the flow control device assembly, including elevation changes, to the Engineer of Record for confirmation that the device still meets the design requirements.

5.7.4.8. Operations and Maintenance Requirements

Detention cistern O&M requirements are provided in *Appendix G (BMP No. [2423](#))*. A plan shall be submitted demonstrating how the O&M requirements will be met.

5.7.5. Other Detention Options

Designers and developers are encouraged to consider creative opportunities for providing detention, when it is required. Athletic fields, roofs, parking lots that are not continually in use, and other large surface areas may provide opportunities for stormwater storage. This section presents other design options for detaining flows to meet flow control requirements.

5.7.5.1. Use of Parking Lots for Additional Detention

Private parking lots may be used to provide additional detention storage for runoff events greater than the 50 percent annual probability (2-year recurrence interval), provided all of the following conditions are met:

- Depth of storage shall be 3 inches or less for parking lots serving retail and office buildings and 6 inches or less for parking lots serving commercial truck traffic only for runoff events up to and including the storm event with a 1 percent annual probability (100-year recurrence interval flow).
- The emergency overflow path shall be identified and noted on the engineering plan. The overflow shall not create a significant adverse impact to downhill properties or drainage system.
- Fire lanes used for emergency equipment shall be free of ponding water for all runoff events up to and including the storm event with a 1 percent annual probability (100-year recurrence interval flow).

5.7.5.2. Use of Roofs for Detention

Detention ponding on roofs may be used to meet flow control requirements provided all of the following conditions are met:

- The roof support structure shall be analyzed by a structural engineer to address the weight of ponded water.
- The roof area shall be sufficiently waterproofed to achieve a minimum service life of 30 years.
- The minimum pitch of the roof area shall be 0.25 inch per foot.
- An overflow system shall be designed to safely convey the peak flow with a 1 percent annual probability (100-year recurrence interval flow).
- A mechanism shall be included in the design to allow the ponding area to be drained for maintenance purposes or in the event the restrictor device is plugged.

5.8. Non-Infiltrating BMPs

Non-infiltrating BMPs are designed to remove pollutants contained in stormwater runoff. Some non-infiltrating BMPs may provide low levels of flow control as a secondary benefit. The BMP categories in this section include:

- Non-infiltrating Bioretention
- Biofiltration Swales
- Filter Strips/Drains
- Sand Filters
- Wet Ponds
- Wet Vaults
- Stormwater Treatment Wetlands
- Combined Detention and Wet Pool Facilities
- Oil/Water Separators
- Proprietary and Emerging Water Quality Treatment Technologies

5.8.1. Design Requirements for Non-infiltrating BMPs

5.8.1.1. Site and Design Considerations

Refer to each non-infiltrating BMP section for setback requirements intended to protect adjacent properties, receiving waters, and other critical areas (i.e., landslide-prone areas).

The Phosphorus Removal and Enhanced Treatment performance goals, described in Sections 3.5.2.2 and 0, respectively, include treatment train options in which more than one type of BMP is used and the sequence of BMPs is prescribed. The specific pollutant removal role of the second or third BMP in a treatment train often assumes that significant solids settling has already occurred.

This section summarizes the placement of non-infiltrating BMPs in relation to detention BMPs as shown in Table 5-435.44. Also note that oil control BMPs shall be located upstream of [other non-infiltrating BMPs and detention-BMPs](#), and as close to the source of the oil-generating activity as possible.

Table 5.435.44. Non-infiltrating BMP Placement in Relation to Detention BMP.

Non-infiltrating BMP	Preceding Detention BMP	Following Detention BMP
Basic Biofiltration Swale (Section 5.8.3)	Allowed	Allowed—prolonged flows may reduce vegetation survival. Consider wet biofiltration swale instead.
Wet Biofiltration Swale (Section 5.8.3)	Allowed	Allowed.
Filter Strip (Section 5.8.4)	Allowed	Not allowed— must shall be installed before flows concentrate; cannot effectively be re-dispersed.
Basic or Large Sand Filter or Sand Filter Vault (Section 5.8.5)	Allowed—presettling and control of floatables needed	Allowed—sand filters downstream of detention BMPs may require field adjustments if prolonged flows cause sand saturation, anoxic conditions, and phosphorus release.
Basic or Large Wet Pond (Section 5.8.6)	Allowed	Allowed—less water level fluctuation in ponds downstream of detention may improve aesthetic qualities and performance.
Wet Vault (Section 5.8.7)	Allowed	Allowed.
Stormwater Treatment Wetland/Pond (Section 5.8.8)	Allowed	Allowed—less water level fluctuation and better plant diversity are possible if the stormwater wetland is located downstream of the detention BMP.
Proprietary and Emerging Water Quality Treatment Technologies (Section 5.8.11)	Allowed	Allowed—depending on the type of technology.

5.8.2. Non-Infiltrating Bioretention

5.8.2.1. Description

Non-infiltrating bioretention facilities are earthen depressions or vertical walled containers with a designed soil mix and plants adapted to the local climate and soil moisture conditions. Stormwater is stored as surface ponding before it filters through the underlying bioretention soil. Stormwater that exceeds the surface storage capacity overflows to an adjacent drainage system. Treated water is collected by an underdrain and discharged. Bioretention facilities can be individual cells or multiple cells connected in series.

Unlike infiltrating bioretention (refer to *Section 5.4.4*), non-infiltrating bioretention facilities typically include a ~~liner or other low-permeability or~~ impermeable barrier to ~~limit or~~ prevent infiltration to the underlying soil. However, if all the horizontal setback requirements for infiltrating facilities are met and there are no geotechnical or contamination concerns, the liner may be omitted.

Two variations of non-infiltrating bioretention facilities are included in this section:

- **Non-infiltrating bioretention facility:** These bioretention facilities can have either sloped sides (e.g., an earthen depression with a liner) or vertical sides (e.g., vertical walled ~~impermeable~~ container). Non-infiltrating bioretention shall have an underdrain. These facilities may or may not have an outlet control structure to attenuate underdrain flows prior to release.
- **Non-infiltrating bioretention facility series:** Non-infiltrating bioretention facilities with sloped sides or vertical sides may be connected in a series, with the overflows of upstream cells directed to downstream cells to provide additional flow control and/or treatment, and conveyance.

5.8.2.2. Performance Mechanisms

Non-infiltrating bioretention provides flow control via detention, attenuation, and losses due to interception, evaporation, and transpiration. Water quality treatment is accomplished through sedimentation, filtration, adsorption, uptake, or biodegradation and transformation of pollutants by soil organisms, soil media, and plants.

5.8.2.3. *Applicability*

Non-infiltrating bioretention can be designed to provide on-site stormwater management, flow control, and/or water quality treatment. These facilities can be applied to meet or partially meet the requirements listed below.

BMP	On-site		Flow Control			Water Quality				Conveyance
	List	Standard	Forest	Pasture	Peak	Basic	Enhanced	Oil Control	Phosphorus	
Non-Infiltrating Bioretention	✓	✓ ^a	✓ ^a	✓ ^a	✓ ^a	✓	✓			✓ ^b

^a Standard may be partially or completely achieved depending upon ponding depth, contributing area, and use of orifice control.

^b Non-infiltrating bioretention facilities may be connected in series, with the overflows of upstream cells directed to downstream cells to provide conveyance.

5.8.2.4. *Site Considerations*

Because typically non-infiltrating bioretention facilities do not infiltrate water to surrounding soils (water discharges via an underdrain and surface overflow), these BMPs are not subject to infiltration facility requirements. However, some infiltration requirements apply if a liner is not used (refer to Volume 3, Section 5.8.5-22.5 below).

Non-infiltrating bioretention is not permitted if the underdrained water would be routed to a nutrient-critical receiving water. Non-infiltrating bioretention is also not permitted within a setback equal to the height of the slope to a maximum of 50 feet from the top of steep slope or known landslide area.

Non-infiltrating bioretention is allowed in the side, front, and rear yard/setbacks that are required by the Land Use Code (SMC Title 23) in certain land use zones. However, if the facility extends above grade (e.g., a non-infiltrating bioretention planter that is partially or completely above the surrounding grade), then the amount of the yard/setback that it can cover may be restricted if the facility is over a certain height or width. Height is measured from the lowest adjacent grade. Width is the outside width and is measured perpendicular to the setback line.

Refer to the Land Use Code (SMC Title 23) for the specific heights and widths that trigger yard/setback coverage limitations for GSI features. Note: The requirements vary based on zoning and are not required in all zones.

Note: The “total storage capacity” mentioned in these code sections does not apply to non-infiltrating bioretention. Also, larger non-infiltrating bioretention planters may be permitted without restriction of the amount of yard/setback coverage if they meet the standards for retaining walls within a required yard/setback.

Refer to *Appendix C* for additional infeasibility criteria for the On-site List Approach.

5.8.2.5. Design Criteria

Typical components of non-infiltrating bioretention facilities with sloped sides and vertical sides are shown in Figures 5.295-24 and 5.305-25, respectively.

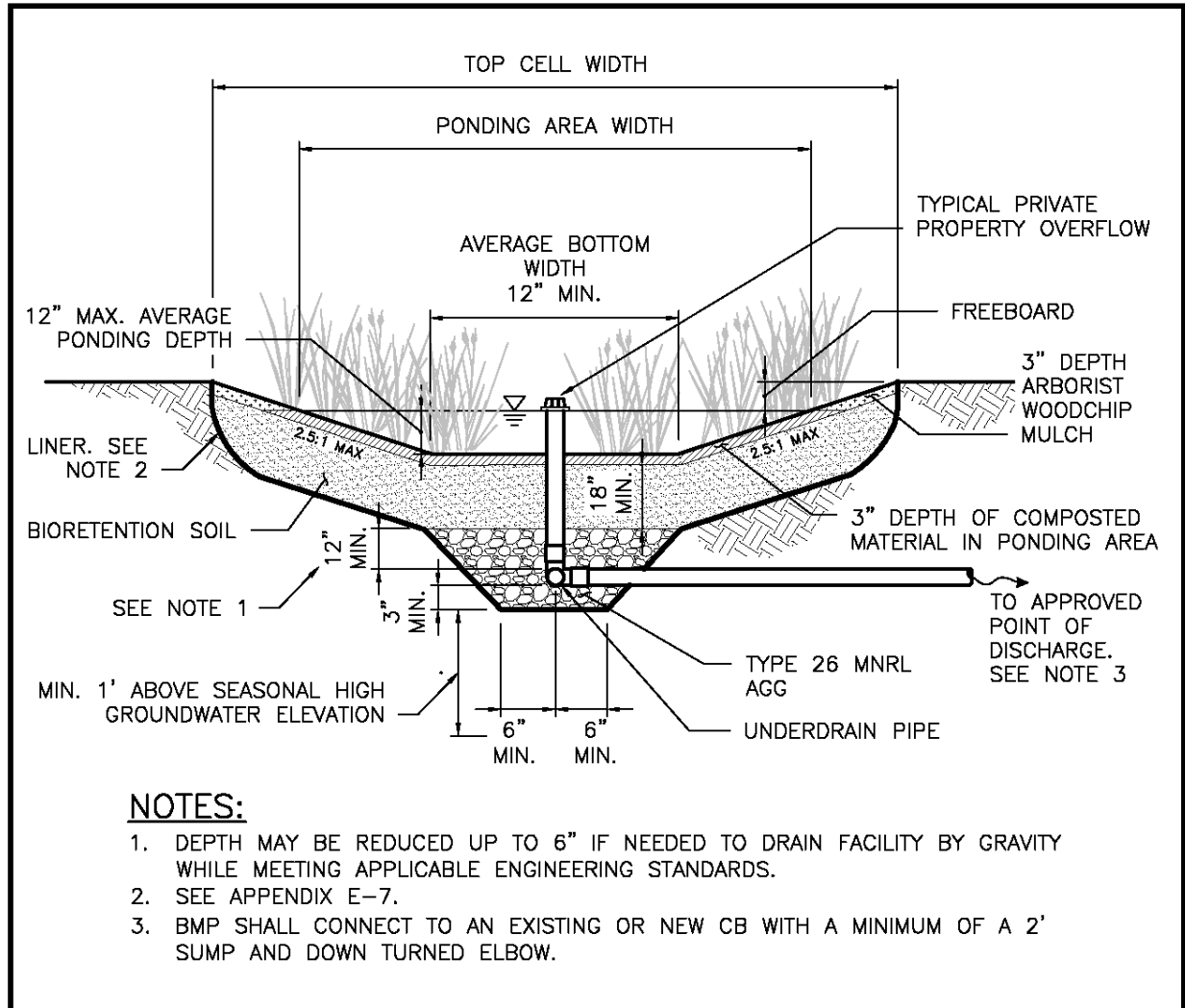

Figure 5.295-24. Non-infiltrating Bioretention Facility with Sloped Sides.

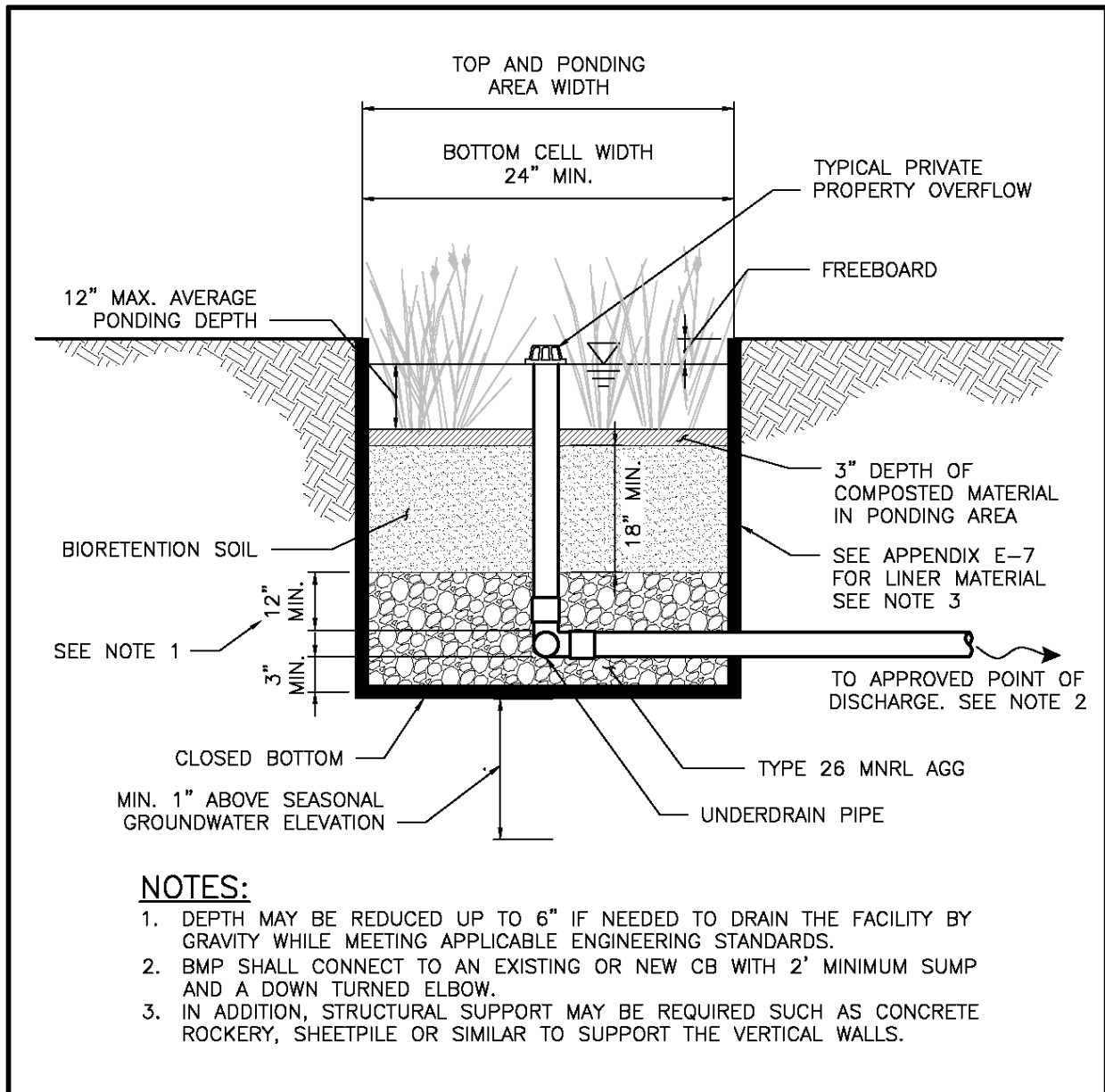

Figure 5.305-25. Non-infiltrating Bioretention Facility with Vertical Sides.

The design criteria for non-infiltrating bioretention is the same as presented for infiltrating bioretention in *Section 5.4.4*, with the following exceptions:

- [Typically, non-infiltrating bioretention includes a hydraulic restriction layer to restrict or prevent infiltration into surrounding soils. The type of hydraulic restriction layer required depends on site setbacks:](#)
 - [If the area available for siting is within the setback for a contaminated site or landfill \(refer to *Volume 3, Section 3.2*\), an impermeable liner shall be used to create a hydraulic restriction layer. Refer to *Appendix E, Section E-7* for liner design criteria.](#)

- If the area available for siting meets the setback from contamination and landfills, but not the other minimum horizontal setback requirements for infiltrating facilities (refer to *Volume 3, Section 3.2*), low-permeability liner or walls shall be used as the hydraulic restriction layer. The facility shall include a hydraulic restriction layer to prevent infiltration to surrounding soils. The facility may be composed of a low permeability (e.g., concrete) container with a closed bottom, or may be lined with a low permeability material (e.g., clay, geomembrane liner) to prevent infiltration. Refer to *Appendix E, Section E-7* for liner design criteria.
 - If Horizontal Setbacks and Site Constraints for infiltration can be met (refer to *Volume 3, Section 3.2*), no liner is required.
 - Where the inflow or discharge line enters or exits the BMP, measures shall be taken to prevent drainage from entering the trench backfill or pipe bedding such as factory boots or trench dams using bentonite, low density concrete fill, etc.
 - The facility shall be equipped with an underdrain.
 - While not required, it is recommended that facilities with contributing drainage areas up to 5,000 square feet, be designed with a 0.25-inch-diameter removable and maintainable orifice to improve flow control performance.
 - *Special Instructions:* The City acknowledges that the current bioretention soil mix has the tendency to export nutrients and is currently in the process of developing a new mix to address this problem. Until a new mix is developed, use either:
 - Sand, meeting the gradation required for a sand filter as well as the vegetation requirements for a sand filter (*Section 5.8.5*), or
 - A mix that is 70% by volume Mineral Aggregate as specified in the City of Seattle Standard Specifications Section 9-03.2(2) and 30% compost per Section 9-14.4(8) which otherwise meets the requirements for bioretention soil in Section 9-14 may be used instead of the bioretention soil shown in the figures above *for this BMP only*.
- Once the new mix is available, use of that mix will supersede these special instructions.

5.8.2.6. *BMP Sizing*

Sizing for On-site List Approach

Non-infiltrating bioretention may be selected to meet the On-site List Requirement (refer to *Section 3.3.1* and *Appendix C* for infeasibility criteria). To meet the requirement, the facility shall be sized according to the sizing factors provided in Table 5.445.45. ~~Sizing factors are based on achieving a minimum wetted surface area of 5 percent of the contributing area, increased by 11 percent (i.e., multiplied by 1.11) to account for reduced performance due to the presence of an underdrain.~~

Factors are organized by cell ponding depth, contributing area, and side slope. To select the appropriate sizing factor the design ponding depth shall be rounded down to the nearest depth in the sizing table, or sizing factors may be linearly interpolated for intermediate ponding depths (e.g., between 4 and 6 inches ponding).

The facility shall meet the general requirements for non-infiltrating bioretention outlined in this section plus the following specific requirements:

- The bottom area shall be sized using the applicable sizing factor.
- It is preferred that the bottom area is flat, but up to 3 percent slope is permitted.
- For facilities with sloped sides, the side slopes within the ponded area shall be no steeper than 2.5H:1V.
- The bioretention soil depth shall be a minimum of 18 inches.
- The average ponding depth for the cell shall be no less than the selected ponding depth.

Table 5.445.45. On-site List Sizing for Non-infiltrating Bioretention.

Bioretention Configuration	Average Ponding Depth	Contributing Area (sf)	Sizing Factor for Facility Bottom Area ^a
			On-site List
Sloped sides	2 inches	0 – 10,000	1.3% 5.0%
	6 inches	≤2,000	[0.0059 x A] - 3.215 3.9%
		2,001 – 10,000	[0.0097 x A] - 11.297
	12 inches	≤2,700	0.4% 2.6%
2,701 – 10,000		[0.0052 x A] - 12.1092	
Vertical sides	6 inches	0 – 10,000	1.2% 5.6%
	12 inches	0 – 10,000	1.0% 5.6%

NA – not applicable.

Bioretention Bottom Area = Contributing Hard Surface Area x Factor (%) / 100.

Hard Surface Area Managed = Bioretention Bottom Area ÷ Factor (%) / 100.

^a ~~Sizing factors are based on achieving a minimum wetted surface area of 5 percent of the contributing area, increased by 11 percent (i.e., multiplied by 1.11) to account for reduced performance due to the presence of an underdrain.~~

The bottom area for the cell is calculated as a function of the hard surface area routed to it. As an example, the bottom area of the bioretention cell with sloped sides would be equal to 2.6 percent of the hard surface area routed to it when the average ponding depth is 12 inches. For facilities with sloped sides, the top area is calculated as a function of the cell bottom area and the side slopes up to the total facility depth (i.e., ponding and freeboard depth).

Pre-sized Approach for Flow Control and Water Quality Treatment

The Pre-sized Approach may be used for projects with new and replaced hard surface areas up to 10,000 square feet. Under the Pre-sized Approach (refer to *Section 4.1.2*), pre-sized non-infiltrating bioretention facilities may be used to achieve ~~the Peak Control and~~ Water Quality Treatment Standards. Sizing factors and equations for non-infiltrating bioretention facilities with underdrains are provided in Table 5.455.46. Factors are organized by side slopes (i.e., sloped sides or vertical sides), performance standard, facility ponding depth, and contributing area. To select the appropriate sizing factor, the design ponding depth shall be

rounded down to the nearest depth in the sizing table, or sizing factors may be linearly interpolated for intermediate ponding depths (e.g., between 6 and 12 inches ponding).

To use these pre-sized facilities to meet performance standards, the bioretention facility shall meet the general requirements outlined in this section plus the following specific requirements:

- The bottom area shall be sized using the applicable sizing factor or equation. ~~When used to meet the Peak Control Standard, the facility size shall not be significantly larger (i.e., area shall not be more than 25 percent larger) than prescribed by the Peak Control Standard sizing factor because peak flow control performance may be diminished for larger facilities.~~
- It is preferred that the bottom area is flat, but up to a 3 percent slope is permitted.
- For facilities with sloped sides, the side slopes within the ponded area shall be no steeper than 2.5H:1V.
- The bioretention soil depth shall be a minimum of 18 inches.
- The average ponding depth for the cell shall be no less than the selected ponding depth.

Table 5.455.46. Pre-Sized Sizing Factors and Equations for Non-Infiltrating Bioretention.

Bioretention Configuration	Average Ponding Depth	Contributing Area (sf)	Sizing Factor/Equation for Facility Bottom Area		
			Pre-developed Pasture Standard	Peak Control Standard	Water Quality Treatment
Sloped sides	2 inches	0 – 10,000	NA ^a	NA ^a	1.3%
	6 inches	≤2,000	NA ^a	NA ^a	[0.0059 x A] - 3.215
		2,001 – 10,000			[0.0097 x A] - 41.311.297
	12 inches	≤ 2,700	NA ^a	NA ^a 3% to 4.5% ^b	2.0%0.4%
2,701 – 10,000		[0.0052 x A] - 42.112.092			
Vertical sides	6 inches	0 – 10,000	NA ^a	NA ^a	4.3%1.2%
	12 inches	0 – 10,000	NA ^a	NA ^a 4.5% ^b	4.1%1.0%

NA – not applicable

For Sizing Factors: Bioretention Facility Bottom Area = Contributing Hard Surface Area x Factor (%) / 100

Hard Surface Area Managed = Bioretention Facility Bottom Area ÷ Factor (%) / 100

For Sizing Equations: Bioretention Facility Bottom Area (sf) = [Factor x A (sf)] + Integer.

Hard Surface Area Managed (sf) = [Bioretention Bottom Area (sf) - Integer] ÷ Factor.

^a Bioretention facilities with underdrains are not capable of achieving the standard unless orifice controls are used.

~~^b When used to meet the Peak Control Standard, the facility size shall not be significantly larger (i.e., area shall not be more than 25 percent larger) than prescribed by the sizing factor (or sizing factor range) because flow control performance may be diminished for larger facilities (larger facilities will not pond water sufficiently to slow flows).~~

The *bottom area* for the bioretention facility area is calculated as a function of the hard surface area routed to it. As an example, to meet the Water Quality Treatment Standard, the bottom area of the bioretention facility with vertical sides and an average of 12 inches of ponding would be equal to 1.1 percent of the hard surface area routed to it. The bottom area

of same facility with slopes sides would be calculated as: $0.0052 \times$ contributing hard surface area - 12.1. All area values shall be in square feet. For facilities with sloped sides, the top area is calculated as a function of the cell bottom area and the side slopes up to the total facility depth (i.e., ponding and freeboard depth).

Instead of using the Pre-sized Approach, non-infiltrating bioretention facilities can be sized using a continuous simulation hydrologic model as described in the following section.

Modeling Approach for On-site Performance Standard, Flow Control, and Water Quality Treatment

When using continuous simulation hydrologic modeling to size non-infiltrating bioretention, the assumptions listed for infiltrating bioretention in Table 5.215.24 shall be applied, with the exception that the facility is modeled with no infiltration to underlying soil. [Refer to the Approval Status of Continuous Simulation Models section of the SWMMWW for a list of currently approved models.](#) ~~Note that W~~When using currently available modeling methods, non-infiltrating bioretention is not capable of meeting the Pre-developed Forested or Pre-developed Pasture Standard. ~~Facilities may be sized to achieve the Peak Control Standard with an optimized ratio of planter area and contributing surface area, but performance may diminish with larger and smaller ratios.~~

5.8.2.7. Minimum Construction Requirements

Minimum construction requirements associated with non-infiltrating bioretention facilities include the following:

- Place bioretention soil in accordance with the requirements of City of Seattle Standard Specifications.
- Protect bioretention soil in cells from sediment during construction and do not use as sediment control facilities.

Refer to the Puget Sound LID Manual for additional guidance on bioretention construction.

5.8.2.8. Operations and Maintenance Requirements

Non-infiltrating bioretention O&M requirements are provided in *Appendix G (BMP No. [2322](#))*.

5.8.3. Biofiltration Swales

5.8.3.1. Description

A biofiltration swale is an open, gently sloped, vegetated channel designed to treat stormwater. Biofiltration swales are designed so that stormwater will flow evenly across the entire width of a densely vegetated channel. The four biofiltration swales described in this section are:

1. **Basic biofiltration swale:** a swale with a densely vegetated channel, with all runoff entering at the head of the swale.
2. **Wet biofiltration swale:** similar to the basic swale, but due to site conditions and/or influent conditions, this swale is designed to accommodate saturated soil conditions. It is appropriate for locations where the longitudinal slope is very low, water tables are high, or continuous low base flow is present.
3. **Continuous inflow biofiltration swale:** similar to the basic swale, but runoff enters at multiple locations along the length of the swale. The basic swale design is modified by increasing the swale length to achieve an equivalent average residence time.
4. **Compost-amended biofiltration swale:** same as the basic swale, but with a 3-inch compost blanket within the channel of the swale.

5.8.3.2. Performance Mechanisms

Pollutant removal occurs by filtration as stormwater moves through the vegetation, enhancing sedimentation, and trapping pollutants within the compost or vegetation.

5.8.3.3. Applicability

A swale can be designed for water quality treatment and conveyance of stormwater flow. This combined use can reduce development costs by eliminating the need for separate conveyance and treatment systems. Biofiltration swales are typically configured as flow-through systems, with little or no detention or storage. This BMP can be applied to meet the requirements as summarized below.

BMP	On-site		Flow Control			Water Quality				Conveyance
	List	Standard	Forest	Pasture	Peak	Basic	Enhanced	Oil Control	Phosphorus	
Basic Biofiltration Swale						✓	TT-A or TT-B		TT-A	✓
Wet Biofiltration Swale						✓	TT-A or TT-B		TT-A	✓
Continuous Inflow Biofiltration Swale						✓	TT-A or TT-B		TT-A	✓
Compost-amended Biofiltration Swale						✓	✓	✓		✓

TT-A = Treatment Train A ([must shall](#) be followed by a Basic Sand Filter or Sand Filter Vault (*Section 5.8.5*))

TT-B = Treatment Train B ([must shall](#) be followed by an approved Proprietary and Emerging Water Quality Treatment Technology (*Section 5.8.11*))

Refer to *Section 3.5.2.2* for more information on Two-BMP Treatment Trains.

5.8.3.4. Site Considerations

The following are common considerations for determining the feasibility of biofiltration swales for a particular site.

- Setbacks and restrictions:
 - All biofiltration swales shall be a minimum of 50 feet from the top of any steep (greater than 40 percent) slope. A geotechnical analysis and report shall be prepared addressing the potential impact of the facility on a slope steeper than 15 percent.
 - The water surface at the outlet invert elevation shall be set back 100 feet from existing septic system drain fields. This setback may be reduced with written approval of Public Health – Seattle & King County.
- Biofiltration swales are generally suitable for contributing areas of less than 5 acres.
- Biofiltration swales may be used for linear areas along roadways, driveways, and parking lots.
- Swales may be incorporated into a project's landscape design with either a mowable grass swale or water tolerant vegetation.
- Shaded areas, including deep channels, with less than 6 hours of sunlight during the summer months can inhibit vegetation growth.
- Stormwater runoff containing high concentrations of oil and grease impairs the treatment capability of a swale. Oil control options described in *Section 5.8.10* should be applied upstream of the biofiltration swale in these situations.
- Most biofiltration swales are designed to be on-line facilities with flows above the water quality design flow or volume passing through the facility with lesser or no pollutant removal. However, an offline design (where flows above the water quality design flows or volume are bypassed around the facility) may be preferred in some cases to avoid scour and damage to vegetation during high flows. An additional benefit of designing swales to be offline is that the stability check, which may make the swale larger, is not necessary (refer to *Sections 5.8.3.5 – Design Criteria* and *5.8.3.6 – BMP Sizing*).
- Minimum footprint is 100 feet by 20 feet. The actual footprint will depend on the bottom width, side slopes, and length, which are all dependent on the design flows (refer to *Section 5.8.3.6 – BMP Sizing*).
- Alignment should avoid sharp bends where erosion of the swale side slope can occur. However, gradual meandering bends in the swale are desirable for aesthetic purposes and to promote slower flow.
- Leaves and needles that can smother the grass or clog part of the swale [flowpath](#) can be a maintenance concern. Landscaping plans should take into consideration the problems that falling leaves and needles can cause for swale performance and maintenance. Landscape planter beds should be designed and located so that soil does not erode from the beds and enter a nearby biofiltration swale.

- Wet biofiltration swales are applied where a basic biofiltration swale is desired but not allowed or advisable because one or more of the following conditions exist:
 - The swale is on till soils and is downstream of a detention pond providing flow control.
 - Saturated soil conditions are likely because of seeps, continuous base flow, or high groundwater on the site.
 - Longitudinal slopes are less than 2 percent.
- A continuous inflow biofiltration swale is recommended when the following conditions exist:
 - Inflows are not concentrated or when flow enters at frequent points along the swale.
 - Unconcentrated inflow occurs along roadways that that have no curbs, where runoff sheet flows across the shoulder to the swale.
- A continuous inflow biofiltration swale is not appropriate when significant lateral flows enter a swale at some point downstream from the head of the swale. In this situation, the swale length shall be recalculated from the point of entry to provide adequate treatment for the increased flow.

Additional site considerations may apply depending on site conditions and other factors.

5.8.3.5. Design Criteria

The following provides a description and requirements for the components of biofiltration swales. Typical plan and profile views of a biofiltration swale are provided in Figure [5.315-26](#). Some or all of the components may be used for a given application depending on the site characteristics and restrictions, pollutant loading, and design objectives. Design criteria are provided in this section or in Volume V of the SWMMWW for the following elements:

Design Element	SWMMWW Design Criteria	Seattle-specific Design Criteria
Level spreaders	✓	✓
Underdrain (if any)	✓	✓
Low-flow drains (if any)		✓
Outlet and overflow		✓
Access		✓
Soil amendment		✓
Vegetation criteria Planting requirements	✓	✓
Dividing berm	✓	
Check dams or steps (if any)	✓	
High-flow bypass (if any)	✓	

Refer to BMP T9.10 – Basic Biofiltration Swale, BMP T9.20 – Wet Biofiltration Swale, and BMP T9.30 – Continuous Inflow Biofiltration Swale in Volume V of the SWMMWW for specific design criteria. Refer to the WSDOT Highway Runoff Manual under BMP RT.04 – Biofiltration Swale for design criteria for compost-amended biofiltration swales (CABS). In addition to

criteria developed by Ecology and WSDOT, the City has also developed specific design criteria for several design elements which are summarized below.

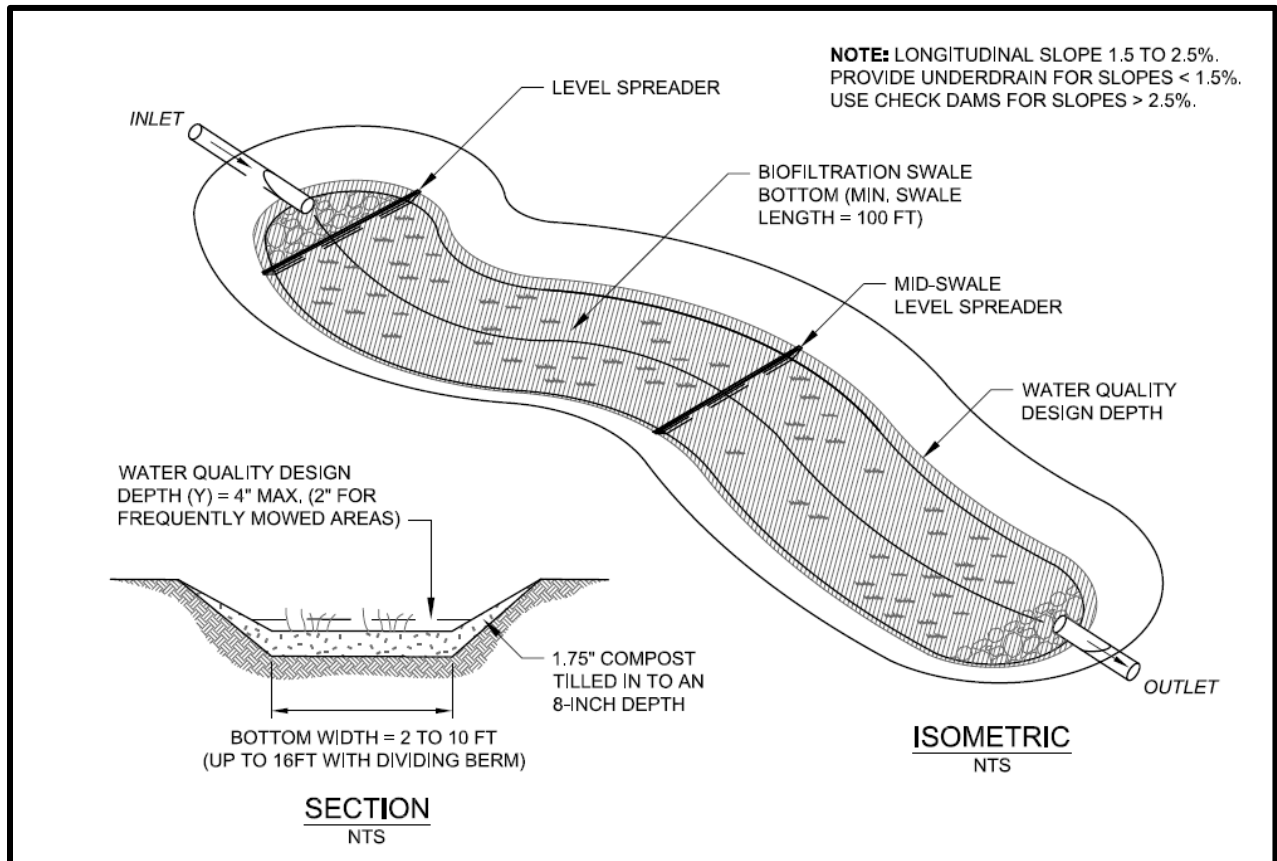

Figure 5.315-26. Biofiltration Swale Plan and Profile.

Level Spreaders

Refer to BMP T9.10 – Basic Biofiltration Swale, BMP T9.20 – Wet Biofiltration Swale, and BMP T9.30 – Continuous Inflow Biofiltration Swale in Volume V of the SWMMWW for biofiltration swale design considerations.

In addition, the City of Seattle requires level spreaders at the toe of vertical drops (check dams). Design guidelines and example design figures for level spreaders are provided in *Appendix E*.

Underdrains

Refer to BMP T9.10 – Basic Biofiltration Swale, BMP T9.20 – Wet Biofiltration Swale, and BMP T9.30 – Continuous Inflow Biofiltration Swale in Volume V of the SWMMWW for design considerations.

In addition, the City of Seattle requires underdrains for swales less than 1.5 percent longitudinal slope on till soils.

Low-flow Drains

Low-flow drains are narrow surface drains filled with pea gravel that run lengthwise through the swale to discharge base flows; they should not be confused with underdrains. Wet biofiltration swales are typically preferred when seeps, continuous base flow, or high groundwater is present. Alternatively, if a low-flow drain is proposed, the following requirements apply to biofiltration swales installed in Seattle:

- If a swale will receive base flows because of seeps and springs on site, then either a low-flow drain shall be provided or a wet biofiltration swale shall be used. In general, base flows less than 0.01 cubic feet per second (cfs) per acre can be handled with a low-flow drain. If flows are likely to be in excess of this level, a wet biofiltration swale should be used. Low-flow drains are not required for wet biofiltration swales.
- If a low-flow drain is used, it shall extend the entire length of the swale.
- The low-flow drain shall be a minimum of 6 inches deep, and its width shall be no greater than 5 percent of the calculated swale bottom width. Adjust the bottom width accordingly to maintain the necessary design bottom width for treatment.
- If an anchored plate or concrete sump is used for flow spreading at the swale inlet, the plate or sump wall shall have a v-notch (maximum top width equal to 5 percent of swale width) or holes to allow preferential exit of low flows into the drain. Additional design guidelines for level spreaders are provided in *Appendix E*.

Outlet and Overflow

All biofiltration swales shall include an outlet and overflow to an approved point of discharge per *Section 4.3.3*.

Access

Access requirements specific to biofiltration swale installations in Seattle are summarized below.

Access Requirement	Basic and Continuous Inflow Biofiltration Swale	Wet Biofiltration Swale
Access locations	Half the length of the swale	Inflow and outflow only
Access road width	Minimum of 10 feet	
Access road curves	Minimum width of 15 feet and a minimum outside radius of 40 feet	
Wheel strips made of modular grid pavement (refer to Section 5.4.6 Figure 5-26) ^a	<ul style="list-style-type: none"> • Support 16,000 pound vehicle • Firm underlying soil or structural fill (not amended topsoil) • Fill or cover with underlying soil (no amendments) and seed with grass • Strip width = 18 inches • Not counted as treatment area • Not allowed in biofiltration swales with underdrains 	Not allowed

^a If a low-flow drain is also needed, a portion of the wheel strip may be filled with pea gravel as appropriate to form the drain.

Soil Amendment

The following requirements shall be followed for biofiltration swales installed in Seattle:

- The condition of the soil is critical to support healthy grass growth. Native topsoil that has been stockpiled on site or in-situ soil may be used provided that it meets the soil quality criteria described in *Section 4.5.2*. Soil amendments are required if underlying soil is not suitable. Refer to *Section 5.1* for information regarding Soil Amendment BMP requirements.
- If the longitudinal slope is less than 1.5 percent (requiring the use of underdrains along the swale length), the subgrade should contain 10 percent or more of sand to promote infiltration of standing water. If sand is added to promote drainage, the soil or sand substrate shall still be amended with compost.

Vegetation Criteria Planting Requirements

Refer to BMP T9.10 – Basic Biofiltration Swale, BMP T9.20 – Wet Biofiltration Swale, and BMP T9.30 – Continuous Inflow Biofiltration Swale in Volume V of the SWMMWW for biofiltration [swale vegetation criteria planting requirements](#). The following additional [planting requirements vegetation criteria](#) shall be followed for biofiltration swales installed in Seattle:

- Grass shall be established throughout the entire treatment area of the biofiltration swale subject to the following provisions:
 - Seeding is best performed in spring (mid-March to June) or fall (late September to October). For summer seeding, sprinkler systems or other measures for watering grass seed shall be provided.
 - Seed may be applied via hydroseeding or broadcast application.
 - Irrigation is required during the first summer following installation if seeding occurs in spring or summer. Swales seeded in the fall may not need irrigation. Site planning shall address the need for sprinklers or other means of irrigation.
- Swales are subject to both dry and wet conditions and accumulation of sediment and debris. A mixture of dry-area and wet-area grass species that can continue to grow through silt deposits is most effective. Acceptable grass seed mixes for the Seattle area are provided in the City of Seattle Standard Specifications (9-14). As an alternative to these mixes, a horticultural or erosion control specialist may develop a seed specification tailored to the site. *Appendix E* includes a plant list for biofiltration swales that lists grasses or other plants that are particularly tolerant of wet conditions.
- Sod may be used where needed to initiate adequate growth. If sod is used, the sod shall be grown from a seed mix suitable for a biofiltration swale and clay content shall be less than 10 percent.
- During seeding, slow-release fertilizers may be applied to speed the growth of grass. If the swale discharges to a nutrient-critical receiving water, low phosphorus fertilizers (such as formulations in the proportion 3:1:3 N-P-K or less) or a slow-release phosphorus formulation such as rock phosphate or bone meal should be used. A typical fertilizer application rate should be 2 pounds per 1,000 square feet. If animal manures are used in the fertilizer, they shall be sterilized to avoid leaching fecal coliform bacteria into receiving waters.

- A grassy swale should be incorporated into the project site landscape design. Shrubs may be planted along the edges of a swale (above the water quality treatment level) provided that exposure of the swale bottom to sunlight and maintenance accessibility are not compromised. Note: For swales used to convey high flows, the plant material selected shall bind the soil adequately to prevent erosion.

5.8.3.6. *BMP Sizing*

Refer to BMP T9.10 – Basic Biofiltration Swale, BMP T9.20 – Wet Biofiltration Swale, and BMP T9.30 – Continuous Inflow Biofiltration Swale in Volume V of the SWMMWW for BMP Sizing considerations.

Biofiltration swale design procedures are described in the SWMMWW for the following steps:

- Preliminary steps (P)
- Design steps [for biofiltration swale capacity](#) (D)
- Stability check steps [\(SC\)](#)

Seattle-specific guidance for Preliminary Step P-1 includes the following:

- For offline swales, the high flow bypass shall be designed so that all flows up to and including the water quality design flow rate are directed to the swale. The water quality design flow rate (Q) is calculated by multiplying the design flow determined by an approved continuous runoff model by an offline ratio of 3.0.
- For on-line swales, Q is determined by multiplying the design flow determined by an approved continuous runoff model by an on-line ratio of 1.65.

5.8.3.7. *Minimum Construction Requirements*

Minimum construction requirements associated with biofiltration swales include the following:

- Grade [biofiltration](#) swales to attain uniform longitudinal and lateral slopes.
- Avoid compaction during construction.
- Do not put biofiltration swales into operation until areas of exposed soil in the contributing drainage areas have been sufficiently stabilized. Deposition of eroded soils can impede the growth of grass in the swale and reduce [water quality swale](#) treatment effectiveness. Therefore, erosion and sediment control measures shall remain in place until the [biofiltration](#) swale vegetation is established (refer to *Volume 2 – Construction Stormwater Control*).
- Protect newly constructed [biofiltration](#) swales from stormwater flows until grass has been established by diverting flows or by covering the swale bottom with clear plastic until the grass is well rooted. If these actions are not feasible, place an erosion control blanket per City of Seattle Standard [Specification Plan No. 9-14.5\(2\)](#) over the freshly applied seed mix. Sod may be used as a temporary cover during the wet season, but sodded areas shall be reseeded with a suitable grass mix as soon as the weather is conducive to seed germination. Remove sod before reseeding.

5.8.3.8. Operations and Maintenance Requirements

Basic, wet, and continuous inflow biofiltration swale O&M requirements are provided in *Appendix G (BMPs No. 9 and 10)*. Compost-amended biofiltration swale O&M requirements can be found in the WSDOT Highway Runoff Manual under BMP RT.04 – Biofiltration Swale.

5.8.4. Filter Strips/Drains

5.8.4.1. Description

A filter strip is a grassy slope that receives unconcentrated runoff from adjacent hard surfaces such as a parking lots, driveways, or roadways. Filter strips are graded to maintain sheet flow over their entire width. Compost and other amendments can be incorporated into filter strips designs to provide enhanced treatment (refer to *Section 3.5.2.3*). The following three types of filter strip BMPs are described in this section:

1. **VegetatedBasic filter strip:** a flat filter strip with no side slopes. Polluted stormwater is distributed as sheet flow across the inlet width of the filter strip.
2. **Compost-amended vegetated filter strip (CAVFS):** An enhanced treatment option, similar to the [vegetatedbasic](#) filter strip, but the filter area is compost-amended to improve infiltration characteristics, increase surface roughness, and improve plant sustainability. Once permanent vegetation is established, the advantages of the CAVFS are higher surface roughness, greater retention and infiltration capacity, improved removal of soluble cationic contaminants through sorption, improved overall vegetative health, and a reduction of invasive weeds. Compost-amended systems have somewhat higher construction costs due to more expensive materials, but require less land area for [water qualityrunoff](#) treatment, which can reduce overall costs.
3. **Media filter drain (MFD):** Previously referred to as the ecology embankment, a linear flow-through stormwater treatment device that can be sited along roadway side-slopes (conventional design) and medians (dual MFD), borrow ditches, or other linear depressions. Cut-slope applications may also be considered. MFDs have four basic components: a gravel no-vegetation zone, a vegetated filter strip, the MFD mix bed, and an optional gravel-filled underdrain trench or layer of crushed surfacing base course (CSBC). The layer of CSBC shall be porous enough to allow treated flows to freely drain away from the MFD mix.

5.8.4.2. Performance Mechanisms

Filter strips remove pollutants primarily by filtration as stormwater moves through the grass blades. This enhances sedimentation and traps pollutants which adhere to the grass and thatch. Pollutants can also be adsorbed by the underlying soil when infiltration occurs, but the extent of infiltration depends on the type of soil, the density of grass, and the slope of the filter strip. The MFD removes suspended solids, phosphorus, and metals from roadway runoff through physical straining, ion exchange, carbonate precipitation, and biofiltration.

5.8.4.3. Applicability

A filter strip can be designed for both treatment and conveyance of stormwater flow. This combined use can reduce development costs by eliminating the need for separate conveyance and treatment systems. [VegetatedBasic](#) filter strips, CAVFS, and MFDs are typically configured as flow-through systems, with little or no detention or storage. This BMP can be applied to meet the requirements as summarized below.

BMP	On-site		Flow Control			Water Quality				Conveyance
	List	Standard	Forest	Pasture	Peak	Basic	Enhanced	Oil Control	Phosphorus	
VegetatedBasic Filter Strip						✓	TT-A or TT-B		TT-A or TT-B	✓
CAVFS						✓	✓			✓
MFD						✓	✓			✓

TT-A = Treatment Train A ([must-shall](#) be followed by a Linear Sand Filter (Section 5.8.5).

TT-B = Treatment Train B ([must-shall](#) be preceded by a Linear Sand Filter (Section 5.8.5).

Refer to Section 3.5.2.2 for more information on Two-BMP Treatment Trains.

5.8.4.4. Site Considerations

The following are site considerations for determining the feasibility of filter strips for a particular site.

- Setbacks and restrictions:
 - The filter strips are not typically permitted within landslide-prone areas as defined by the Regulations for Environmentally Critical Areas (SMC, Section 25.09.020).
 - The filter strips are not typically permitted within a setback above a steep slope area (SMC, Section 25.09.020). The setback is calculated as 10 times the height of the steep slope area (to a 500 foot maximum setback). Filter strips within this setback may be feasible provided a [detailed](#) slope stability analysis is completed by a geotechnical engineer. The analysis shall determine the effects that filter strip would have on the steep slope area and adjacent properties.
 - For sites with septic systems, the point of discharge to filter strip shall be downgradient of the drainfield primary and reserve areas.
- Filter strips are suitable for sites with a maximum lateral slope of the contributing area of 2 percent.
- Filter strips are suitable for sites with a maximum longitudinal slope of the contributing area of 5 percent. Contributing areas with longitudinal slopes steeper than 5 percent should either use a different BMP or shall provide energy dissipation and flow spreading mechanisms upslope of the upper edge of the filter strip.
- Filter strips are designed as on-line facilities. They are designed to receive continuous sheet flow from contributing areas and should not be located downstream of detention facilities or other concentrated flows.
- MFDs can be used in areas with longitudinal slopes less than 5 percent.

Additional site considerations may apply depending on site conditions and other factors.

5.8.4.5. Design Criteria

Refer to BMP T9.40 – [VegetatedBasic](#) Filter Strip, BMP T7.40 – CAVFS, and BMP T8.40 – MFD in Volume V of the SWMMWW for filter strip design criteria. Additional descriptions,

applications, and design details are provided in the WSDOT Highway Runoff Manual under BMP RT.02 – Vegetated Filter Strip and RT.07 – MFD. The City allows the use of MFDs per the Ecology-approved designs outlined in the WSDOT Highway Runoff Manual.

5.8.4.6. BMP Sizing

Filter strips shall be designed to meet the criteria listed in Table 5-465.47. Refer to BMP T9.40 – [Vegetated Basic Filter Strip](#), BMP T7.40 – CAVFS, and BMP T8.40 – MFD in Volume V of the SWMMWW for additional information on filter strip sizing methods.

Table 5-465.47. Basic and Compost Amended Vegetated Filter Strip Design and Sizing Criteria.

Design Parameter	Vegetated Basic Filter Strip	CAVFS	MFD
Longitudinal slope	1 – 33%	1 – 15%	5%
Lateral slope	NA		2 – 25%
Maximum velocity	0.5 feet/second		NA
Maximum water depth	1 inch		NA
Manning's roughness coefficient	0.35	0.40 to 0.55 ^a	NA
Minimum hydraulic residence time at Water Quality Design Flow Rate	9 minutes	NA	NA
Minimum length	NA ^c	NA	NA
Maximum side slope	Inlet edge ≥ 1 inch lower than contributing paved area		NA
Max. tributary drainage flowpath/flow-path	150 feet		
Max. longitudinal slope of contributing area	5% (steeper than 5% need upslope flow spreading and energy dissipation)		5%
Max. lateral slope of contributing area	2% (at the edge of the strip inlet) ^b		NA

^a Manning's n ranges from 0.40 (hydroseeded, grass maintained at 95% density and 4-inch length via mowing, periodic reseeding, and possible landscaping with shrubs) to 0.55 (top-dressed with ≥3 inches compost or mulch [seeded or landscaped]).

^b A stepped series of flow spreaders installed at the head of the strip could compensate for slightly steeper slopes.

^c Length based on achieving required hydraulic residence time.

5.8.4.7. Minimum Construction Requirements

Minimum construction requirements associated with filter strips include the following:

- [Install an erosion control blanket below the design water depth of a vegetated filter strip, at least 4 inches of topsoil, and the selected seed mix. Use a straw mulch or sod above the water line. Refer to Volume 2 – Construction Stormwater Control for erosion and sediment control BMPs.](#)
- Do not put filter strips into operation until areas of exposed soil in the contributing drainage areas have been sufficiently stabilized. Deposition of eroded soils can impede the growth of grass in the filter strip and reduce treatment effectiveness. Erosion and sediment control measures shall remain in place until the filter strip vegetation is established ~~(Refer to Volume 2 – Construction Stormwater Control for erosion and sediment control BMPs).~~
- Avoid compaction of ~~the~~ filter strip areas during construction.

5.8.4.8. Operations and Maintenance Requirements

[VegetatedBasic](#) filter strip O&M requirements are provided *Appendix G (BMP No. 11)*. CAVFS and MFD O&M requirements can be found in the WSDOT Highway Runoff Manual under BMP RT.02 – Vegetated Filter Strip and RT.07 – MFD.

5.8.5. Sand Filters

5.8.5.1. Description

Sand filters are used to provide water quality treatment. The following three sand filter BMPs are described in this section:

1. **Sand filter basins:** Like an infiltration basin, the sand filter basin is an impoundment that temporarily stores stormwater runoff so that it can infiltrate, but instead of infiltrating through the underlying soil, stormwater passes through a constructed sand bed. Sand filters can be sized as either a basic or a large facility to meet different water quality objectives. Sand filter basins are designed with underdrains to collect and route runoff following treatment to the downstream conveyance system.
2. **Sand filter vaults:** A sand filter vault is similar to a sand filter basin, except that the entire facility is installed below grade in a vault. It typically consists of a presettling cell (if pretreatment is not already provided) and a sand filtration cell. Like a sand filter basin, a vault can be sized as either a basic or a large facility to meet different water quality objectives.
3. **Linear sand filters:** Linear sand filters are similar to sand filter vaults, except the vault is configured as a long, shallow, linear system. The vault contains two cells or chambers, one for removing coarse sediment and the other containing sand overlying an underdrain. Runoff usually enters the settling chamber as unconcentrated flow from an adjacent area and overflows to a central weir into the sand portion of the vault.

5.8.5.2. Performance Mechanisms

Sand filters treat stormwater primarily via physical filtration. As stormwater passes through the sand media, pollutants are trapped in the small spaces between sand grains, or adhere to the sand surface. Over time, soil bacteria may also grow in the sand bed and some biological removal may occur.

Sand filter media can also be amended with steel fiber and crushed calcitic limestone to increase dissolved metals removal. Use of amended sand filters [is allowed with the permission of the requires](#) Director's approval.

5.8.5.3. Applicability

A sand filter BMP can be applied to meet the requirements as summarized below.

BMP	On-site		Flow Control			Water Quality			Conveyance	
	List	Standard	Forest	Pasture	Peak	Basic	Enhanced	Oil Control		Phosphorus
Basic Sand Filter						✓	TT-A, TT-B, or TT-C		TT-A, TT-B, TT-C, or TT-D	✓
Large Sand Filter						✓	✓		✓	✓
Sand Filter Vault						✓	TT-A, TT-B, or TT-C		TT-A, TT-B, TT-C, or TT-D	✓
Large Sand Filter Vault						✓	✓		✓	✓
Linear Sand Filter						✓	TT-E or TT-F	✓ ^a	TT-E or TT-F	✓

TT-A = Treatment Train A ([must-shall](#) be preceded by a Basic Wet Pond (Section 5.8.6), Wet Vault (Section 5.8.7), Basic Combined Detention/Wetpool (Section 5.8.9)

TT-B = Treatment Train B ([must-shall](#) be preceded by a Biofiltration Swale (Section 5.8.3)

TT-C = Treatment Train C ([must-shall](#) be followed by an approved Proprietary and Emerging Water Quality Treatment Technology (Section 5.8.11)

TT-D = Treatment Train D ([must-shall](#) be preceded by a Stormwater Treatment Wetland (Section 5.8.8)

TT-E = Treatment Train E ([must-shall](#) be followed by a Filter Strip (Section 5.8.4)

TT-F = Treatment Train F ([must-shall](#) be preceded by a Filter Strip (Section 5.8.4)

Refer to Section 3.5.2.2 for more information on Two-BMP Treatment Trains

^a Linear sand filter may not be used for oil control if it is used to satisfy any other treatment requirement.

5.8.5.4. Site Considerations

Refer to BMP T8.10 – Basic Sand Filter Basin, BMP T8.11 – Large Sand Filter Basin, BMP T8.20 – Sand Filter Vault, and BMP T8.30 – Linear Sand Filter in Volume V of the SWMMWW for site considerations related to sand filters. The following site considerations also apply to sand filters installed in Seattle:

- [Sand filters are not allowed within steep slopes, known landslide areas, and their 15-foot buffers as defined by the regulations for ECAs \(SMC, Section 25.09.012\). For sand filters within a setback equal to the height of the slope to a maximum of 50 feet from the top of steep slope and known landslide area, a slope stability assessment shall be completed by a licensed geotechnical engineer or engineering geologist considering the effects on slope stability due to a leaking or damaged detention BMP. More stringent exfiltration \(i.e., watertightness\) testing of sand filter vaults within a 50-foot setback from the top of the steep slope and known landslide area may be required. No specific setbacks or restrictions apply to closed bottom \(lined\) sand filter. The following setbacks and restrictions apply to open bottom \(unlined\) sand filters.](#)
 - [All open bottom sand filters shall be a minimum of 50 feet from the top of any steep \(greater than 40 percent\) slope. A geotechnical analysis and report shall be prepared addressing the potential impact of the open bottom sand filter on a slope steeper than 15 percent.](#)

~~○ The water surface at the outlet invert elevation shall be set back 100 feet from existing septic system drain fields. This setback may be reduced with written approval of Public Health—Seattle & King County.~~

- A sand filter can add landscape interest and should be incorporated into the project landscape design.
- Interior side slopes may be stepped with flat areas to provide informal seating with a game or play area below.
- Perennial beds can be planted above the overflow water surface elevation. However, large shrubs and trees are not recommended because shading limits evaporation and can inhibit drying of the filter surface. In addition, falling leaves and needles can clog the filter surface, requiring more frequent maintenance.

Additional site considerations may apply depending on site conditions and other factors.

5.8.5.5. Design Criteria

The following provides a description and requirements for the components of sand filters. Some or all of the components may be used for a given application depending on the site characteristics and restrictions, pollutant loading, and design objectives. Design criteria are provided in this section or in Volume V of the SWMMWW for the following elements:

Design Element	SWMMWW Design Criteria	Seattle-specific Design Criteria
Presettling	✓	✓
Liner	✓	✓
Geometry and composition	✓	✓
Structural requirements	✓	✓
Underdrains (if any)	✓	✓
Sand media	✓	✓
Vegetation (if any)		✓
Access	✓	✓
Offline/on-line facilities	✓	
Inlets and outlets	✓	

Refer to BMP T8.10 – Basic Sand Filter Basin, BMP T8.11 – Large Sand Filter Basin, BMP T8.20 – Sand Filter Vault, and BMP T8.30 – Linear Sand Filter in Volume V of the SWMMWW for sand filter basin and sand filter vault design criteria. In addition to Ecology’s criteria, the City has also developed specific design criteria for several design elements which are summarized below.

Presettling

Presettling is required to prevent clogging and extend the service life of the sand filter media. Presettling design requirements are described in *Section 4.4.5*. Refer to BMP T8.10 – Basic Sand Filter Basin, BMP T8.11 – Large Sand Filter Basin, BMP T8.20 – Sand Filter Vault, and BMP T8.30 – Linear Sand Filter in Volume V of the SWMMWW for sand filter basin and sand filter vault presettling requirements.

The following additional criteria apply specifically to sand filter vaults installed in Seattle:

- The presettling cell bottom may be longitudinally level or inclined toward the inlet.
- To facilitate sediment removal, the presettling cell bottom shall also slope from each side towards the center at a minimum of 5 percent, forming a broad “v.”
- More than one “v” may be used to minimize presettling cell depth.

Liners

Refer to BMP T8.10 – Basic Sand Filter Basin, BMP T8.11 – Large Sand Filter Basin, BMP T8.20 – Sand Filter Vault, and BMP T8.30 – Linear Sand Filter in Volume V of the SWMMWW for sand filter liner requirements.

- Refer to *Appendix E* for additional information on liner design criteria.

Geometry and Composition

Refer to BMP T8.10 – Basic Sand Filter Basin, BMP T8.11 – Large Sand Filter Basin, BMP T8.20 – Sand Filter Vault, and BMP T8.30 – Linear Sand Filter in Volume V of the SWMMWW for sand filter basin and sand filter geometry and composition requirements.

The following additional criterion applies to all sand filter types installed in Seattle:

- Depth of storage over the filter media (d) shall be 6 feet maximum

The following additional criterion applies specifically to linear sand filters installed in Seattle:

- If separated from traffic areas, a linear sand filter may be covered or open, but if covered, the cover shall be removable for the entire length of the filter. Covers shall be grated if flow to the filter is from sheet flow.

Structural Requirements

Refer to BMP T8.10 – Basic Sand Filter Basin, BMP T8.11 – Large Sand Filter Basin, BMP T8.20 – Sand Filter Vault, and BMP T8.30 – Linear Sand Filter in Volume V of the SWMMWW for sand filter structural requirements.

The following additional criteria apply specifically to linear sand filters installed in Seattle:

- A linear sand filter vault shall be concrete (precast/prefabricated or cast-in-place). The concrete shall conform to the “Material” requirements for wet vaults (refer to *Section 5.8.7.5*).
- At the discretion of SDCI, the sediment cell may be made of materials other than concrete, provided water can be evenly spread for uniform delivery into the sand filter cell.
- Where linear sand filters are located in traffic areas, they shall meet the structural requirements specified for wet vaults (refer to *Section 5.8.7.5*). The sediment cell shall have a removable grated cover that meets HS-25 traffic loading requirements. The cover over the sand filter cell may be either solid or grated.

Underdrains

Underdrains are required to allow the sand media to dry out between events. Refer to BMP T8.10 – Basic Sand Filter Basin, BMP T8.11 – Large Sand Filter Basin, BMP T8.20 – Sand Filter Vault, and BMP T8.30 – Linear Sand Filter in Volume V of the SWMMWW for sand filter underdrain requirements.

The following additional requirements for underdrains also apply to sand filters installed in Seattle:

- If a drain strip is used for lateral drainage, the strip shall be placed at the slope specified by the manufacturer but at least at 0.5 percent. All drain strips shall extend to the central collector pipe. Drain strip installations shall be analyzed for conveyance because manufactured products vary in the amount of flow they are designed to handle.
- Underdrain pipes shall be per City of Seattle Standard Plan No. 291.
- A geotextile fabric (refer to specifications in *Appendix E*) shall be used between the sand layer and drain rock or gravel and placed so that 2 inches of drain rock/gravel is above the fabric. Drain rock shall be 0.75- to 1.5-inch rock or gravel backfill, washed free of clay and organic material. Cover the geotextile fabric with 1 inch of drain rock/gravel. Use 0.75- to 1.5-inch drain rock or gravel backfill, washed free of clay and organic material. These requirements can be met with City of Seattle Mineral Aggregate Type 4.

Sand Media

Refer to BMP T8.10 – Basic Sand Filter Basin, BMP T8.11 – Large Sand Filter Basin, BMP T8.20 – Sand Filter Vault, and BMP T8.30 – Linear Sand Filter in Volume V of the SWMMWW for sand filter media requirements.

The following additional requirement for sand media also applies to sand filters installed in Seattle:

- Sand filters shall drain freely. Sand media cannot be saturated for extended periods because under these conditions, oxygen can be depleted, releasing pollutants such as dissolved metals and phosphorus that are more mobile under anoxic conditions. To prevent this release of pollutants that have accumulated in the media, sand filters shall be designed to drain the water quality design storm volume within 72 hours.

Vegetation

Vegetation requirements for basic and large sand filter basins are not included in Volume V of the SWMMWW; however, the City has developed the following guidelines for grass cover for sand filter basins installed in Seattle:

- No topsoil may be added to sand filter beds because fine-grained materials (e.g., silt and clay) reduce the hydraulic capacity of the filter.
- Grass shall tolerate the demanding environment of the sand bed. Sand filters experience long periods of saturation during the winter wet season, followed by extended dry periods during the summer. Modeling predicts that sand filters will be

dry about 60 percent of the time in a typical year. Consequently, vegetation shall be capable of surviving drought, as well as wet conditions.

- *Appendix E* includes a plant list for sand filters. These species can generally survive approximately 1 month of submersion while dormant in the winter (until about February 15), but they can only withstand about 1 to 2 weeks of submersion after mid-February.
- Several grass species in the plant list in *Appendix E* can withstand summer drying and are fairly tolerant of infertile soils. In general, planting a mixture of three or more species is recommended. This ensures better coverage since tolerance of the different species is somewhat different, and the best adapted grasses will spread more rapidly than the others. Legumes, such as clover, fix nitrogen and can thrive in low-fertility soils such as sands. This makes them particularly good choices for planting the sand filter bed.
- A sports field sod grown in sand may be used on the sand surface. No other sod may be used due to the high clay content in most sod soils.
- To prevent overuse that could compact and potentially damage the filter surface, permanent structures (e.g., playground equipment or bleachers) are not permitted. Temporary structures or equipment shall be removed for filter maintenance.
- Seed should be applied in spring or mid to late fall unless irrigation is provided. If the filter is seeded during the dry summer months, surface irrigation is required to ensure that the seeds germinate and survive. Seed shall be applied at 80 pounds per acre.
- Slow-release fertilizers may be applied to improve germination.
- Low phosphorus fertilizers (such as formulations in the proportion 3:1:3 N-P-K or less) or a slow-release phosphorus formulation should be used.

Access

Refer to BMP T8.10 – Basic Sand Filter Basin, BMP T8.11 – Large Sand Filter Basin, BMP T8.20 – Sand Filter Vault, and BMP T8.30 – Linear Sand Filter in Volume V of the SWMMWW for sand filter access requirements.

The following additional criteria apply specifically to sand filter vaults installed in Seattle:

- Provision for access is the same as for wet vaults (refer to *Section 5.8.7.5*). However, the arch culvert sections allowed for wet vaults may not be used for sand filter vaults. Free access to the entire sand bed is needed for maintenance. Removable panels shall be provided over the entire sand bed.
- An access road shall be provided to the inlet and outlet of a sand filter for inspection and maintenance purposes.

5.8.5.6. *BMP Sizing*

Sand filters shall be designed to capture and treat 91 percent of the total runoff volume (95 percent for large sand filters) as calculated by an approved continuous runoff model. Only 9 percent of the total runoff volume (5 percent for large sand filters) may bypass or overflow from the sand filter facility. A flow splitter may be used to facilitate bypass. Design guidelines

for flow splitters are provided in *Appendix E*. The following design criteria apply to all sand filters, unless otherwise noted for Sand Filter Vaults and Linear Sand Filters.

Two methods are provided for sizing sand filters (Simplified Sizing Approach and Facility Modeling), both of which are based on Darcy's law:

$$Q = KiA$$

Where:

Q = water quality design flow (cfs)

K = hydraulic conductivity of the media (fps)

A = surface area perpendicular to the direction of flow (sf)

i = hydraulic gradient (ft/ft) for a constant head and constant media depth

$$i = \frac{h}{L}$$

Where:

h = average depth of water above the filter (ft), defined as d/2

d = maximum water storage depth above the filter surface (ft)

L = thickness of sand media (ft)

Although it is not seen directly, Darcy's law underlies both the simple and the modeling design methods. V, or more correctly, 1/V, is the direct input in the sand filter design. The relationship between V and K is revealed by equating Darcy's law and the equation of continuity, Q = VA. (Note: When water is flowing into the ground, V is commonly called the infiltration rate. It is ordinarily measured via a soil infiltration test.)

Specifically:

$$Q = KiA \quad \text{and} \quad Q = VA \text{ so,}$$

$$VA = KiA \quad \text{or} \quad V = Ki$$

Note that $V \neq K$. The infiltration rate is not the same as the hydraulic conductivity, but they do have the same units (distance per time). K can be equated to V by dividing V by the hydraulic gradient i, which is defined above. The hydraulic conductivity K does not change with head nor is it dependent on the thickness of the media, only on the characteristics of the media and the fluid. The hydraulic conductivity of 1 inch per hour (2.315×10^{-5} fps) used in this design is based on bench-scale tests of conditioned rather than clean sand. This design hydraulic conductivity represents the average sand bed condition as silt is captured and held in the filter bed. Unlike the hydraulic conductivity, the infiltration rate V changes with head and media thickness, although the media thickness is constant in the sand filter design. Table [5-475.48](#) shows values of V for different water depths d (d = 2h).

Table 5-475.48. Sand Filter Design Parameters.

	Sand Filter Design Parameters					
Facility ponding depth d (ft)	1	2	3	4	5	6
Infiltration rate V (in/hr) ^a	1.33	1.67	2.00	2.33	2.67	3.00
1/V (min/in)	45	36	30	26	22.5	20

^a The infiltration rate is not used directly, but is provided for information. V equals the hydraulic conductivity, K, times the hydraulic gradient, i. The hydraulic conductivity used is 1 in/hr. The hydraulic gradient = (h + L)/L, where h = d/2 and L = the sand depth (1.5 ft).

Simplified Sizing Approach

The simplified sizing approach is taken from the *King County Surface Water Design Manual*. It uses standard values to define filter hydraulic characteristics for determining the sand surface area. This method is useful for planning purposes, for a first approximation to begin iterations in the modeling method, or when use of a computer model is not desired or available. The simplified sizing method very often results in a larger filter than the modeling method. More robust calculation methods, using an approved continuous runoff model, may be used (refer to the following section on modeling method).

King County developed the simplified sizing approach to design sand filters that meet the required treatment volume without performing detailed modeling. Steps for the simplified sizing approach are summarized below.

- *Step 1 -Determine maximum depth of water above sand filter.* This depth is defined as the depth at which water begins to overflow the reservoir pond, and it depends on site topography and hydraulic constraints. The depth is chosen by the designer.
- *Step 2 – Determine site characteristics.* Determine the total number of hard surface acres and the total number of grass acres draining to the sand filter. Determine whether the site is on till or outwash soils.
- *Step 3 – Calculate minimum required surface area for the sand filter.* Determine the sand filter area by multiplying the values in Table 5-485.50 by the site acreage from Step 2 using the following equation:

$$A_{sf} = 0.7(T_i A_i + T_{tg} A_{tg} + T_{og} A_{og})$$

Where:

A_{sf} = sand filter area (sf)

0.7 = adjustment factor to account for routing effect on size

$T_{i,tg,og}$ = tributary area per soil/cover type (acres)

$A_{i,tg,og}$ = filter area per soil/cover type (sf/acre) from Table 5-485.49.

Table 5.485.49. Sand Filter Area Increments for Various Soil and Cover Types.

Treatment Goal	Maximum Depth above Filter (ft)	Soil and Cover Types [filter area (sf)/tributary area (acre)]		
		A_i Hard Surface	A_t Till Grass	A_{og} Outwash Grass
BASIC	6	760	160	140
	3	1,140	240	210
	1	1,711	360	314
LARGE	6	1,179	279	250
	3	1,769	419	370
	1	2,654	629	550

Forested areas may be ignored. Vegetated areas other than grass may still be represented as grass for the simple sizing method, or the detailed routing method may be employed using actual cover types.

The values in Table 5.48 were derived as follows. Flows were estimated using the KCRTS model for one acre of the cover types selected in the table. Darcy's law ($Q = KiA$) was then used to determine sand filter area using this flow Q , the hydraulic gradient i for the various ponding depths given, and a hydraulic conductivity k of 2.3×10^{-5} fps (1 in/hr). The hydraulic gradient i was calculated as $(h+l)/l$, where h = the average depth of water above the filter, taken to be the ponding depth $d/2$, and l = the thickness of the sand layer, which is 1.5 ft. The hydraulic conductivity represents a partially plugged sand condition found by bench-scale testing using successive trials with turbid water.

For depths between the values given in the table, areas can be interpolated. For depths outside the range presented in the table, the Facility Modeling method shall be used.

- **Step 4 – Size the underdrain system.** The underdrain system is sized to convey the peak filtered flows to the outlet. Underdrains can be used in lieu of analyzing conveyance capacity for feeder pipes (refer to Design Criteria section). Strip drains, if used, shall be analyzed for conveyance per manufacturer's specifications.

The collector pipe (i.e., the pipe collecting flows from the rest of the underdrain system) shall be sized to convey the 2-year, 15-minute peak flow with 1 foot of head above the invert of the upstream end of the collector pipe.

Intent – The underdrain shall be able to remove standing water from beneath the sand. If standing water remains, the sand will remain saturated. This could cause oxygen depletion and reduced conditions in the sand, allowing some pollutants to become mobile and be released from the filter to downstream receiving waters.

Simple Method Sizing Example:

For a site with 2 acres of hard surface area and 2 acres of till grass draining to the sand filter, and 3 feet of head above the filter, the required sand area for a basic size sand filter would be as follows:

Site Areas		Values for Basic Size (from Table 5.485.50)		
2 acres	x	1,140 sf/acre	=	2,280 sf
+ 2 acres	x	240 sf/acre	=	<u>480 sf</u>
			=	2,760 sf

Because the site is located in Seattle, the “regional scale factor” (refer to Step 1) is 1.0. Multiply 2,760 square feet by the 0.7 adjustment factor (refer to Step 4).

$$2,760 \text{ sf} \times 1.0 \times 0.7 = 1,930 \text{ sf}$$

The required sand bed area is therefore 1,930 square feet.

Note: Find the total facility area by adding 3H:1V side slopes for the 3-foot ponding depth plus extra vertical height to convey the 100-year flow. For example, if the total pond depth is 3.5 feet, the sand filter will require a total land area of (44 feet + 10.5 feet) x (44 feet + 10.5 feet) = 2,970 square feet, plus access and setback requirements.

Modeling Approach

When using continuous modeling to size a sand filter, apply the assumptions listed in Table 5.495.50.

Table 5.495.50. Sand Filter Design and Sizing Criteria.

Variable	Basic Sand Filter Basin	Large Sand Filter Basin	Sand Filter Vault	Linear Sand Filter
Precipitation Series	Seattle 158-year, 5-minute series			
Computational Time Step	15 minutes			
HSPF Parameters	LSUR, SLSUR, NSUR shall be adjusted per Appendix F			
Inflows to Facility	Continuous model output for applicable water quality design flow rate and volume			
Ponding Depth	Maximum water depth over the filter media			Maximum of 1 foot
Precipitation Applied to Facility	Yes		No	Yes (grated cover) No (solid cover)
Evaporation Applied to Facility	Yes		No	Yes (grated cover) No (solid cover)
Media depth	18 inches or other as designed			Minimum of 12 inches of sand and 8 inches of drain rock
Sand Media Hydraulic Conductivity	1 inch per hour			
Use Wetted Surface Area	Only if side slopes are 3H:1V or flatter		No	No

5.8.5.7. Minimum Construction Requirements

Refer to BMP T8.10 – Basic Sand Filter Basin, BMP T8.11 – Large Sand Filter Basin, BMP T8.20 – Sand Filter Vault, and BMP T8.30 – Linear Sand Filter in Volume V of the SWMMWW for sand filter minimum construction requirements.

5.8.5.8. Operations and Maintenance Requirements

Sand filter O&M requirements are provided in *Appendix G (BMPs No. 15 and 16)*.

5.8.6. Wet Ponds

5.8.6.1. Description

Wet ponds are constructed stormwater ponds that retain a permanent pool of water (i.e., a wet pool or dead storage) at least during the wet season.

As an option, a shallow marsh area can be created within the permanent pool volume to provide additional treatment for nutrient removal. Peak control can be provided in the live storage area above the permanent pool.

5.8.6.2. Performance Mechanisms

The volume of the wet pool, which slows down the velocity of incoming stormwater, allows particulates and particulate-bound pollutants to settle and is a key factor in determining wet pond effectiveness. Biological uptake also acts as a secondary pollutant removal mechanism.

5.8.6.3. Applicability

Wet ponds can be applied to meet the requirements as summarized below. Wet ponds can be combined with detention storage to provide flow control (refer to *Section 5.8.9*).

BMP	On-site		Flow Control			Water Quality				Conveyance
	List	Standard	Forest	Pasture	Peak	Basic	Enhanced	Oil Control	Phosphorus	
Basic Wet Pond						✓	TT-B		TT-A	✓
Large Wet Pond ^a						✓	✓		✓	✓

TT-A = Treatment Train A ([must-shall](#) be followed by a Basic Sand Filter or Sand Filter Vault (*Section 5.8.5*))

TT-B = Treatment Train B ([must-shall](#) be followed by a Sand Filter or Sand Filter Vault (*Section 5.8.5*) or an approved Proprietary and Emerging Water Quality Treatment Technology (*Section 5.8.11*))

Refer to *Section 3.5.2.2* for more information on Two-BMP Treatment Trains

^a A large wet pond requires a wet pool volume at least 1.5 times greater than for a basic wet pond.

5.8.6.4. Site Considerations

Site considerations for wet ponds are the same as those outlined for detention ponds under *Section 5.7.1.4*. Wet ponds require a larger area than a biofiltration swale or a sand filter, but can be integrated into the contours of a site fairly easily and function well for any size project.

Wet ponds work best when the water already in the pond is moved out en masse by incoming flows; a phenomenon called “plug flow.” Because treatment works on this displacement principle, the wet pool storage of wet ponds may be provided below the groundwater level without interfering unduly with treatment effectiveness. However, if combined with a detention function, the live storage [must-shall](#) be above the seasonal high groundwater level.

[Wet ponds are not allowed within steep slopes, known landslide areas, and their 15-foot buffers as defined by the regulations for ECAs \(SMC, Section 25.09.012\). For wet ponds within a setback equal to the height of the slope to a maximum of 50 feet from the top of steep slope and known landslide area, a slope stability assessment shall be completed by a licensed geotechnical engineer or engineering geologist considering the effects on slope stability due to a leaking or damaged BMP. Refer to Volume V of the SWMMWW for wet pond setback requirements.](#)

5.8.6.5. Design Criteria

Design criteria for wet ponds are generally the same as those outlined for detention ponds in *Section 5.7.1.5*. Some or all of the components may be used for a given application depending on the site characteristics and restrictions, pollutant loading, and design objectives. Design criteria are provided in this section or in Volume V of the SWMMWW for the following elements:

Design Element	SWMMWW Design Criteria	Seattle-specific Design Criteria
Pond geometry	✓	✓
Berms and baffles	✓	Refer to Detention Ponds (<i>Section 5.7.1.5</i>)
Presettling basin	✓	✓
Overflow structure	✓	Refer to Detention Ponds (<i>Section 5.7.1.5</i>)
Access	✓	Refer to Detention Ponds (<i>Section 5.7.1.5</i>)
Vegetation and landscaping	✓	✓
Inlets and outlets	✓	

Refer to BMP T10.10: – [Wetponds – Basic and Large Wet ponds](#) in Volume V of the SWMMWW for wet pond design criteria. In addition to Ecology’s criteria, the City has also developed specific design criteria for several design elements, which are summarized below.

Pond Geometry

A wet pond typically consists of two cells [within the wet pond](#) that are separated by a baffle or a berm. A baffle is a vertical divider placed across the entire width of the pond, stopping short of the bottom. A berm is a vertical divider typically built up from the bottom, or if in a vault, connects all the way to the bottom.

Seattle specific requirements include the following:

- The full-length berm or baffle promotes plug flow and enhances quiescence and laminar flow through as much of the entire water volume as possible. Alternative methods to the full-length berm or baffle that provide equivalent flow characteristics may be approved on a case-by-case basis by the City.
- Sediment storage shall be provided in the first cell. The sediment storage shall have a minimum depth of 1 foot. A fixed sediment depth monitor shall be installed in the first

cell to gauge sediment accumulation unless an alternative gauging method is proposed.

- The minimum depth of the first cell shall be 4 feet, exclusive of sediment storage requirements. The depth of the first cell may be greater than the depth of the second cell.
- Maximum pond depth (excluding sediment storage) shall not exceed 8 feet. Deep ponds (greater than 8 feet) may stratify during summer and create low oxygen conditions near the bottom resulting in re-release of phosphorus and other pollutants back into the water. For wet pool depths in excess of 6 feet, it is recommended that some form of recirculation be provided in the summer, such as a fountain, aerator, or small amount of base flow, to prevent stagnation and low dissolved oxygen conditions.
- The ratio of flow path length to width from the inlet to the outlet shall be at least 3:1. The flow path length is defined as the distance from the inlet to the outlet, as measured at mid-depth. The width at mid-depth can be calculated as follows:
$$\text{width} = (\text{average top width} + \text{average bottom width})/2.$$
- Wet ponds with wet pool volumes less than or equal to 4,000 cubic feet may be single celled (i.e., no baffle or berm is required). However, it is especially important in this case that the flow path length be maximized. The ratio of flow path length to width shall be at least 4:1 in single celled wet ponds, but should preferably be 5:1. In addition, a gravity drain for maintenance shall be provided 12 to 18 inches from the pond bottom.

Berms and Baffles

A berm or baffle shall extend across the full width of the wet pond and tie into the wet pond side slopes. Berm and baffle design criteria for wet ponds are the same as those outlined for detention ponds in *Section 5.7.1.5*.

Presettling

Refer to BMP T6.10 – Presettling Basin in Volume V of the SWMMWW for presettling basin design criteria.

Additional presettling requirements for wet ponds installed in Seattle include:

- Provide 1 foot minimum sediment storage depth.
- Provide 1 foot minimum freeboard (above the design water surface elevation).
- If the runoff will be in direct contact with the soil, line the presettling basin in accordance with the provisions in *Appendix E*.
- Catch basins used for presettling shall be per City of Seattle Standard Plan No. 240, 241 or equivalent.

Overflow Structure

Overflow structure design criteria for wet ponds are the same as those outlined for detention ponds under *Section 5.7.1.5*.

Access

Access requirements for wet ponds are the same as those outlined for detention ponds under *Section 5.7.1.5*.

Vegetation and Landscaping

Refer to BMP T10.10: – [Wetponds – Basic and Large](#) ~~Wet ponds~~ in Volume V of the SWMMWW for vegetation and landscaping requirements.

Additional vegetation and landscaping requirements for wet ponds installed in Seattle include:

- Exposed earth on the pond bottom and interior side slopes shall be sodded or seeded with an appropriate seed mixture. All remaining areas of the tract shall be vegetated or stabilized before the pond is put into operation.
- No trees or shrubs may be planted within 10 feet of inlet or outlet pipes or drainage structures such as spillways or flow spreaders. Species with roots that seek water, such as willow or poplar, shall be avoided within 50 feet of pipes or drainage structures.
- Shrubs that form a dense cover should be planted on slopes above the water quality design water surface on at least three sides. The purpose of planting is to discourage waterfowl use of the pond and to provide shading. *Appendix E* includes a plant list for wet pond peripheries.
- Planting is restricted on berms that impound water either permanently or temporarily during storms. Note: This restriction does not apply to cut slopes that form pond banks, only to berms.
 - Trees or shrubs may not be planted on portions of water-impounding berms taller than 4 feet high. Only grasses may be planted on berms taller than 4 feet.
 - Trees planted on portions of water-impounding berms less than 4 feet high shall be small, not higher than 20 feet mature height, and have a fibrous root system. Table [5.495.50](#) provides a list of small trees with these characteristics.
 - These trees reduce the likelihood of blow-down trees, or the possibility of channeling or piping of water through the root systems, which may contribute to structural failure on berms that retain water.
- All landscape material, including grass, shall be planted in topsoil of sufficient organic content and depth. Native underlying soils may be suitable for planting if amended per Soil Amendment BMP requirements in *Section 5.1*.
- Soil in which trees or shrubs are planted may require additional enrichment or additional compost top-dressing. Consult a certified arborist for site-specific recommendations.
- For a naturalistic effect, as well as ease of maintenance, trees or shrubs should be planted in clumps to form “landscape islands” rather than evenly spaced.
 - The landscaped islands shall be a minimum of 6 feet apart, and if set back from fences or other barriers, the setback distance should also be a minimum of 6 feet. Where tree foliage extends low to the ground, the 6 feet of setback should be

counted from the outer dripline of the trees (estimated at maturity). This setback allows a 6-foot-wide mower to pass around and between clumps.

- Evergreen trees and other trees that produce relatively little leaf-fall (such as Oregon ash, mimosa, or locust) are preferred.
- Trees should be set back so that branches do not extend over the pond (to prevent leaf-drop into the water).
- Drought tolerant species are recommended.

5.8.6.6. BMP Sizing

Refer to BMP T10.10:– [Wetponds – Basic and Large Wet Ponds](#) in Volume V of the SWMMWW for BMP Sizing considerations.

5.8.6.7. Minimum Construction Requirements

Refer to BMP T10.10:– [Wetponds – Basic and Large Wet Ponds](#) in Volume V of the SWMMWW for minimum construction requirements. Additional minimum construction requirements for wet ponds installed in Seattle are the same as those outlined for detention ponds under *Section 5.7.1.7*.

5.8.6.8. Operations and Maintenance Requirements

Wet pond O&M requirements are provided in *Appendix G (BMP No. 12)*.

5.8.7. Wet Vaults

5.8.7.1. Description

Wet vaults are drainage facilities that contain permanent pools of water that are filled during the initial runoff from a storm event. They are similar to wet ponds, except the wet pool is constructed below grade.

5.8.7.2. Performance Mechanisms

Wet vaults are designed to optimize water quality treatment by dissipating energy and providing retention time in order to settle out particulate pollutants. Being underground, the wet vault lacks the biological pollutant removal mechanisms, such as algae uptake, present in surface wet ponds. Wet vaults are believed to be ineffective in removing dissolved pollutants such as soluble phosphorus or metals, such as copper.

5.8.7.3. Applicability

A wet vault can be applied to meet the requirements as summarized below. Wet vaults can be combined with detention storage to provide flow control (refer to *Section 5.8.9*).

BMP	On-site		Flow Control			Water Quality				Conveyance
	List	Standard	Forest	Pasture	Peak	Basic	Enhanced	Oil Control	Phosphorus	
Wet Vault						✓	TT-A ^a or TT-B		TT-B	✓
Wet Vault and API oil/water separator						✓		✓		✓

^a The Media Filter media shall be of a nature that has the capability to remove dissolved metals effectively as approved by Ecology and accepted by the Director.

TT-A = Treatment Train A (must-shall be followed by Basic Sand Filter, Sand Filter Vault, or an approved Proprietary and Emerging Water Quality Treatment Technology [*Section 5.8.11*]).

TT-B = Treatment Train B (must-shall be followed by Basic Sand Filter or Sand Filter Vault).

Refer to *Section 3.5.2.2* for more information on Two-BMP Treatment Trains.

5.8.7.4. Site Considerations

The following site considerations can help determine the feasibility of a wet vault for a particular site:

- While there are no specific setback requirements for wet vaults, vault location and vault material approval is required, and may require geotechnical analysis.
- Wet vaults are not allowed within steep slopes, known landslide areas, and their 15-foot buffers as defined by the regulations for ECAs (SMC, Section 25.09.012). For wet vaults within a setback equal to the height of the slope to a maximum of 50 feet from the top of steep slope and known landslide area, a slope stability assessment shall be completed by a licensed geotechnical engineer or engineering geologist considering the effects on slope stability due to a leaking or damaged BMP. More

[stringent exfiltration \(i.e., watertightness\) testing of wet vaults within a 50-foot setback from the top of the steep slope and known landslide area may be required.](#)

- Consider wet vaults where there are space limitations precluding the use of other treatment BMPs.
- Consider how the wet vault grates and access points fit within a site plan, including restrictions for safety considerations and restriction of pollutants entering through grates. Grates shall not operate as inlets. Generally, the surrounding area should be sloped away from grates.
- Consider how access will be provided for Vector trucks for sediment removal.

Additional site considerations may apply depending on site conditions and other factors.

5.8.7.5. Design Criteria

As with wet ponds, the primary design factor that determines the removal efficiency of a wet vault is the volume of the facility. The larger the volume, the higher the potential for pollutant removal. Performance is also improved by avoiding dead zones (like corners) where little exchange occurs, using large length-to-width ratios, dissipating energy at the inlet, and ensuring that flow rates are uniform to the extent possible and not increased between cells.

The methods for designing the wet vault are identical to the methods for designing wet ponds. The following provides a description and requirements for the components of wet vaults. Typical design details and concepts for the wet vault are shown in Figure [5.325-27](#). Some or all of the components may be used for a given application depending on the site characteristics and restrictions, pollutant loading, and design objectives. Design criteria are provided in this section for the following elements:

- Wet vault geometry
- Wet vault configuration
- Inlet, outlet and bypass, if used
- Modifications if combining with a baffle oil/water separator
- Modifications if combining with detention
- Access to cells for maintenance
- Structural requirements

Wet Vault Geometry

The minimum flow length-to-width ratio is 3:1. A greater ratio is desirable. The inlet and outlet should be at opposing corners of the vault to increase the flow path, if possible. Wet pool depths for vaults are the same as specified for wet ponds except for the following modifications:

- The sediment storage shall average 1 foot.
- The depth above sediment storage to the water quality design water surface shall be a minimum of 4 feet deep since planting cannot be used to prevent resuspension of

sediment in shallow water (as it can in open ponds) and to provide for a submerged inlet.

- The maximum depth from finished grade to the vault invert shall be 17 feet to allow for removing sediment by Vactor.

Wet Vault Configuration

The vault shall be separated into three cells by a wall and a baffle (baffle can be removable). The following criteria apply:

- A wall shall be placed at approximately one-third of the wet vault length.
- The wall height shall be set no higher than the water quality design water surface, and no lower than 1 foot below.
- A baffle shall be placed downstream of the wall, with a minimum distance between the wall and the baffle of 5 feet.
- The baffle shall extend from a minimum of 1 foot above the water quality design water surface to a minimum of 1 foot below the invert elevation of the inlet pipe.
- The lowest point of the baffle shall be a minimum of 2 feet from the bottom of the vault, and greater if feasible.

Note: If the vault is less than 2,000 cubic feet (inside dimensions), the vault may be one-celled.

Inlet, Outlet and Bypass

The following criteria apply to inlets, outlets, and bypasses:

- The number of inlets to the wet vault should be limited, and the flow path length shall be maximized from inlet to outlet for all inlets to the vault.
- The inlet to the wet vault shall be submerged with the inlet pipe invert a minimum of 3 feet from the vault bottom (not including sediment storage). The top of the inlet pipe should be submerged at least 1 foot, if possible.

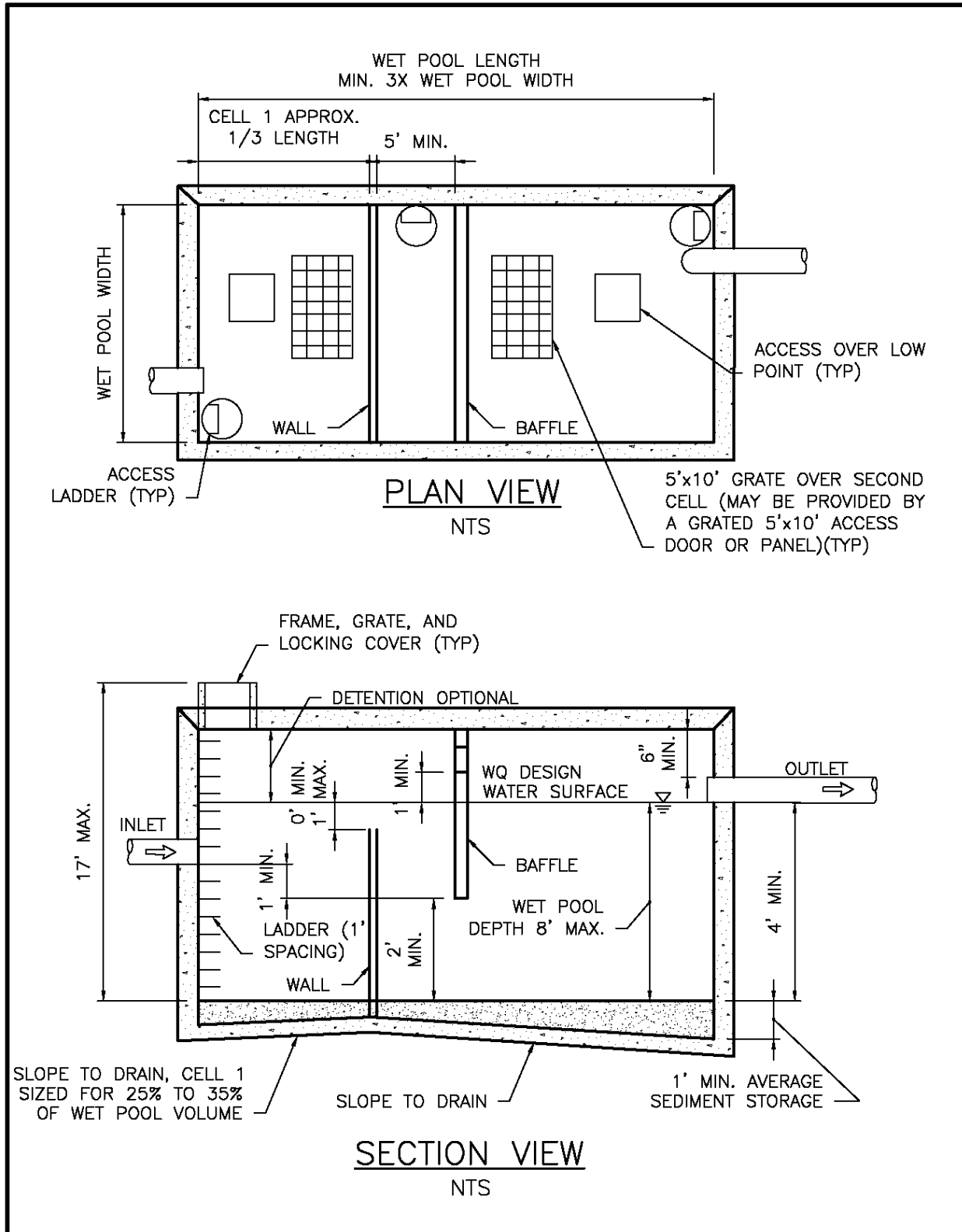

Figure 5.325-27. Typical Wet Vault.

The submerged inlet is to dissipate energy of the incoming flow. The distance from the bottom is to minimize resuspension of settled sediments. Alternative inlet designs that accomplish these objectives are acceptable.

- Unless designed as an offline facility, the capacity of the outlet pipe and available head above the outlet pipe shall be designed to convey the design flow for developed site conditions with a 1 percent annual probability (100-year recurrence) without overtopping the vault. The available head above the outlet pipe shall be a minimum of 6 inches.
- In single cell wet vaults (without a baffle), the outlet pipe shall be back-sloped or have a tee section, the lower arm of which shall extend 1 foot below the water quality design water surface to provide for trapping of oils and floatables in the vault.
- In a combination wet vault with detention, the outlet pipe shall have a flow control riser tee that extends a minimum of 2 feet below the water quality design water surface.
- Where pipes enter and leave the vault they shall be watertight.
- Valved and piped bypass of flows for maintenance is preferred. This isolates the wet vault for safe entry, prevents resuspension of particle pollutants during a cleaning operation, and manages the volume of water for disposal during cleaning.

Modifications if Combining with a Baffle Oil/Water Separator

If the project site is a high-use site and a wet vault is proposed, the vault may be combined with a baffle oil/water separator to meet the water quality treatment requirements with one facility rather than two. Structural modifications and added design criteria are provided below. However, the maintenance requirements for baffle oil/water separators shall be adhered to, in addition to those for a regular wet vault. This will result in more frequent inspection and cleaning than for a wet vault. Refer to *Section 5.8.10.8* for information on maintenance of baffle oil/water separators.

The sizing procedures for the baffle oil/water separator (*Section 5.8.10.6*) shall be run as a check to ensure the vault is large enough. If the oil/water separator sizing procedures result in a larger vault size, increase the wet vault size to match.

An oil retaining baffle shall be provided near the vault outlet. The baffle shall not contain a high-flow overflow, or else the retained oil will be washed out of the vault during large storms.

Additional design criteria for a combined wet vault with baffle oil/water separator are as follows:

- The vault shall have a minimum length-to-width ratio of 5:1.
- The vault shall have a design water depth-to-width ratio of between 1:3 to 1:2.
- The vault shall be watertight and shall be coated to protect from corrosion.
- Separator vaults shall have a shutoff mechanism on the outlet pipe to prevent oil discharges during maintenance and to provide emergency shut-off capability in case of a spill. A valve box and riser shall also be provided.

- Wet vaults used as oil/water separators shall be offline and shall bypass flows greater than the offline water quality design flow (i.e., the water quality design flow multiplied by the offline factor of 3.0).

This design minimizes the entrainment and/or emulsification of previously captured oil during very high flow events.

Modifications if Combining with Detention

The design criteria for detention vaults/[chambers](#) and wet vaults shall both be met, with the exception of the modifications included in BMP T10.40 – Combined Detention and Wetpool Facilities in Volume V of the SWMMWW.

Access to Cells for Maintenance

Refer to the access criteria listed under Detention Vaults/[Chambers](#) (*Section 5.7.3.5*). Access shall be provided to allow personnel to enter and provide emergency egress from all cells of a wet vault using the following criteria:

- For vaults with greater than 1,250 square feet of floor area, a 5-foot by 10-foot removable panel shall be provided over the inlet pipe (instead of a standard frame, grate and solid cover). Alternatively, a separate access vault may be provided.
- For vaults under roadways, the removable panel shall be located outside the travel lanes. Alternatively, multiple standard locking maintenance hole covers may be provided. Removable panels shall be at grade, have stainless steel lifting eyes, and weigh no more than 5 tons per panel.
- All access openings, except those covered by removable panels, shall have round, solid locking lids, or 3-foot square locking covers.
- Vaults with widths of 10 feet or less shall have removable lids.
- Internal structural walls of large vaults shall be provided with separate access risers or openings sufficient for maintenance access between cells.

Structural Requirements

Wet vaults shall conform with the “Materials” and “Structural Stability” criteria specified for detention vaults/[chambers](#) in *Section 5.7.3.5*.

Additional structural design criteria for a combined wet vault with baffle oil/water separator are as follows:

- The vault floor shall be sloped to drain to access points with the intent to allow flushing to Vactor points for sediment removal.
- A minimum of 50 square feet of grate shall be provided over each cell. For vaults in which the surface area of the second cell is greater than 1,250 square feet, 4 percent of the top shall be grated. This requirement may be met by one grate or by many smaller grates distributed over the second cell area. Note: a grated access door can be used to meet this requirement.

The grate allows air contact with the wet pool in order to minimize stagnant conditions which can result in oxygen depletion, especially in warm weather.

- All metal parts shall be corrosion-resistant. Galvanized materials shall not be used since galvanized metal contributes zinc to stormwater, sometimes in very high concentrations. Grates shall be coated for corrosion resistance with elastomeric epoxy or marine paint without zinc.
- The cells of a wet vault shall not be divided into additional subcells by internal walls. If internal structural support is needed, it is preferred that post and pier construction be used to support the vault lid rather than walls. Any walls used within cells shall be positioned so as to lengthen, rather than divide, the flow path.

Treatment effectiveness in wet pool facilities is related to the extent to which plug flow is achieved and short-circuiting and dead zones are avoided. Structural walls placed within the cells can interfere with plug flow and create significant dead zones, reducing treatment effectiveness.

5.8.7.6. BMP Sizing

Refer to [Wet Ponds](#) (Section 5.8.6.6) for BMP Sizing information.

5.8.7.7. Minimum Construction Requirements

Refer to the construction-related issues outlined above as part of the design criteria. Additional construction requirements include:

- Vault floor shall be sloped to drain.
- [Wet vaults shall be field tested for exfiltration \(i.e., watertightness\) as follows:](#)
~~Exfiltration or infiltration testing is required. Contractor shall propose a test method.~~
 - [Plug the inlets and outlet and fill the vault to the top of the wet pool volume \(plus one-half the distance from the outlet invert to the top of the riser on the outlet structure for a combination detention/wet vault\).](#)
 - [The maximum allowable leakage shall not exceed one percent of the volume over a 24-hour period.](#)
- All sediment shall be removed at the end of construction.

5.8.7.8. Operations and Maintenance Requirements

Wet vault O&M requirements are provided in *Appendix G (BMP No. 13)*.

5.8.8. Stormwater Treatment Wetlands

5.8.8.1. Description

Stormwater treatment wetlands are similar to wet ponds, but also provide a shallow marsh area to allow the establishment of emergent wetland aquatic plants, which improves pollutant removal.

5.8.8.2. Performance Mechanisms

Stormwater treatment wetlands remove sediment, metals, and pollutants that bind to humic or organic acids primarily through settling and biological uptake. Secondary performance mechanisms include filtration and soil adsorption. Phosphorus removal in stormwater wetlands is highly variable; therefore stormwater treatment wetlands are not expected to provide phosphorus control.

In land development situations, wetlands are usually constructed for two main reasons: to replace or mitigate impacts when natural wetlands are filled or impacted by development (mitigation wetlands); and to treat stormwater runoff (stormwater treatment wetlands). Mitigation wetlands may not be used as stormwater treatment facilities, because stormwater treatment functions are not compatible with normal wetland function.

5.8.8.3. Applicability

A stormwater treatment wetland can be applied to meet the requirements as summarized below. Stormwater treatment wetlands can be combined with detention storage to provide flow control (refer to *Section 5.8.9*).

BMP	On-site		Flow Control			Water Quality				Conveyance
	List	Standard	Forest	Pasture	Peak	Basic	Enhanced	Oil Control	Phosphorus	
Stormwater treatment wetland						✓	✓		TT-A	✓

TT-A = Treatment Train A (~~must~~ shall be followed by a Basic Sand Filter or Sand Filter Vault (*Section 5.8.5*).

Refer to *Section 3.5.2.2* for more information on Two-BMP Treatment Trains.

5.8.8.4. Site Considerations

Refer to BMP T10.30 – Stormwater Treatment Wetlands in Volume V of the SWMMWW for site considerations. Additional site considerations may apply depending on site conditions and other factors. Refer to Volume V of the SWMMWW for stormwater treatment wetland setback requirements.

5.8.8.5. Design Criteria

The following provides a description and requirements for the components of stormwater treatment wetlands. Some or all of the components may be used for a given application

depending on the site characteristics and restrictions, pollutant loading, and design objectives. Design criteria are provided in this section or in Volume V of the SWMMWW for the following elements:

Design Element	SWMMWW Design Criteria	Seattle-specific Design Criteria
Inlets and outlets	✓	✓
Wetland Geometry	✓	
Lining requirements	✓	
Access and setbacks	✓	
Planting requirements	✓	

Refer to BMP T10.30 – Stormwater Treatment Wetlands Volume V of the SWMMWW for design criteria. In addition to Ecology’s criteria, the City has also developed specific design criteria for inlets and outlets which are summarized below.

Inlets and Outlets

Refer to Wet Ponds (*Section 5.8.6.5*) for inlet and outlet requirements.

The following additional requirements apply to Stormwater Treatment Wetlands installed in Seattle:

- Inlets and outlets shall be placed to maximize the flow path through the facility. The ratio of flow path length to width from the inlet to the outlet shall be at least 3:1. The flow path length is defined as the distance from the inlet to the outlet, as measured at mid-depth. The width at mid-depth can be calculated as follows: width = (average top width + average bottom width)/2.
- To the extent possible create a complex microtopography within the wetland. Design the flow path to maximize sinuous flow between wetland cells.

5.8.8.6. BMP Sizing

Refer to BMP T10.30 – Stormwater Treatment Wetlands in Volume V of the SWMMWW for BMP sizing.

5.8.8.7. Minimum Construction Requirements

Construction requirements are the same as for Wet Ponds (*Section 5.8.6.7*).

5.8.8.8. Operations and Maintenance Requirements

Stormwater treatment wetland O&M requirements are provided in *Appendix G (BMP No. 14)*.

5.8.9. Combined Detention and Wet Pool Facilities

5.8.9.1. Description

Combined detention and water quality wet pool facilities have the appearance of a detention facility but contain a permanent pool of water as well. The following design procedures, requirements, and recommendations cover differences in the design of the stand-alone water quality facility when combined with detention storage. Site considerations, setbacks, and other typical siting and design considerations for combined facilities are the same as specified for each individual facility, unless noted below. The following combined facilities are addressed in this section:

- Detention/wet pond (basic and large)
- Detention/wet vault
- Detention/stormwater wetland.

There are two sizes of the combined wet pond, a basic and a large, but only a basic size for the combined wet vault and combined stormwater wetland. The facility sizes (basic and large) are related to the treatment performance goals (refer to *Section 3.5.2*).

5.8.9.2. Performance Mechanisms

The intent of a combined detention and wet pool facility is to provide water quality treatment in addition to flow control. The three types of combined facilities provide water quality treatment as follows:

- A combined detention/wet pond provides pollutant removal via settling and biological uptake.
- A combined detention/wet vault provides pollutant removal via settling.
- A combined detention/stormwater wetland provides pollutant removal via settling, biological uptake, filtration, and soil adsorption.

5.8.9.3. Applicability

Combined detention and wet pool facilities can be applied to meet the requirements as summarized below.

BMP	On-site		Flow Control			Water Quality				Conveyance
	List	Standard	Forest	Pasture	Peak	Basic	Enhanced	Oil Control	Phosphorus	
Combined detention and wet pond			✓	✓	✓	✓	TT-B		TT-A	✓
Combined detention and wet vault			✓ ^a	✓ ^a	✓ ^a	✓	TT-B		TT-A	✓
Combined detention and stormwater wetland			✓	✓	✓	✓	TT-B		TT-A	✓

^a Standard may be partially or completely achieved depending upon contributing area and minimum orifice size.

TT-A = Treatment Train A ([must shall](#) be followed by a Basic Sand Filter or Sand Filter Vault (*Section 5.8.5*).

TT-B = Treatment Train B ([must shall](#) be followed by a Basic Sand Filter or Sand Filter Vault (*Section 5.8.5*) or an approved Proprietary and Emerging Water Quality Treatment Technology (*Section 5.8.11*).

Refer to *Section 3.5.2.2* for more information on Two-BMP Treatment Trains.

5.8.9.4. Site Considerations

Refer to BMP T10.40 – Combined Detention and Wet Pool Facilities in Volume V of the SWMMWW for site considerations and setback requirements. Additional site considerations may apply depending on site conditions and other factors.

5.8.9.5. Design Criteria

Refer to BMP T10.40 – Combined Detention and Wetpool Facilities in Volume V of the SWMMWW for design criteria.

Combined Detention and Wet Vault

The design criteria for detention vaults/[chambers](#) and wet vaults shall both be met, except the modifications included in BMP T10.40 – Combined Detention and Wetpool Facilities in Volume V of the SWMMWW.

Combined Detention and Stormwater Wetland

The design criteria for detention ponds and stormwater wetlands shall both be met, except the modifications included in BMP T10.40 – Combined Detention and Wetpool Facilities in Volume V of the SWMMWW.

5.8.9.6. BMP Sizing

Refer to BMP T10.40 – Combined Detention and Wetpool Facilities in Volume V of the SWMMWW for BMP sizing.

5.8.9.7. Minimum Construction Requirements

Construction requirements are the same as for Wet Ponds (*Section 5.8.6.7*).

5.8.9.8. Operations and Maintenance Requirements

Detention and wet pool O&M requirements are provided in *Appendix G (BMPs No. 1, No. 3, No. 12, No. 13. and No. 14)*.

5.8.10. Oil/Water Separators

5.8.10.1. Description

Oil/water separators rely on passive mechanisms that take advantage of oil being lighter than water. Oil rises to the surface and can be periodically removed. The two types of oil/water separators typically used for stormwater treatment described in this section are the baffle type or American Petroleum Institute (API) oil/water separator and the coalescing plate (CP) oil/water separator:

1. **Baffle type separator (API):** Baffle (API) oil/water separators use vaults that have multiple cells separated by baffles extending down from the top of the vault. The baffles block oil flow out of the vault. Baffles are also commonly installed at the bottom of the vault to trap solids and sludge that accumulate over time. In many situations, simple floating or more sophisticated mechanical oil skimmers are installed to remove the oil once it has separated from the water.
2. **Coalescing plate (CP) separator:** CP separators are typically manufactured units consisting of a baffled vault containing several inclined corrugated plates stacked and bundled together. The plates are equally spaced (typical plate spacing ranges from 0.25 to 1 inch) and are made of a variety of materials, the most common being fiberglass and polypropylene. Efficient separation results because the plates reduce the vertical distance oil droplets shall rise in order to separate from the stormwater. Once they reach the plate, oil droplets form a film on the plate surface. The film builds up over time until it becomes thick enough to migrate upward along the inclined plate. When the film reaches the edge of the plate, oil is released as large droplets which rise rapidly to the surface, where the oil accumulates until the unit is maintained. Because the plate pack increases treatment effectiveness significantly, CP separators can achieve a specified treatment level with a smaller vault size than a simple baffle separator.

5.8.10.2. Performance Mechanisms

Oil/water separators are designed to remove free oil and are not generally effective in removing oil that has become either chemically or mechanically emulsified or dissolved in the stormwater.

5.8.10.3. Applicability

Oil/water separators can be applied to meet the requirements listed below.

BMP	On-site		Flow Control			Water Quality				Conveyance
	List	Standard	Forest	Pasture	Peak	Basic	Enhanced	Oil Control	Phosphorus	
API oil/water separator								✓		
CP oil/water separator								✓		

API oil/water separators are not effective in removing low concentrations of oil, and therefore, are not recommended for use on sites with very dilute concentrations of TPH. Other stormwater facilities, such as sand filters, biofiltration swales, and emerging water quality treatment technologies may be more applicable under these conditions. Linear sand filters are also approved for oil control (refer to *Section 5.8.5*). Spill control separators are often used as a source control BMP, but are not permitted as a stormwater treatment oil control BMP. Refer to *Volume 4, Source Control* for additional details on spill prevention and control.

5.8.10.4. Site Considerations

The following considerations can influence the feasibility of API oil/water separators for a particular site:

- Oil/water separators shall be installed upstream of other water quality treatment BMPs (except wet vaults), pumps, and conveyance structures that introduce turbulence.
- Oil/water separators may be located upstream or downstream of flow control BMPs.
- Oil/water separators shall be located offline and bypass the incremental portion of flows that exceed the offline water quality design flow rate (refer to *Section 4.2.1*). If it is not possible to locate the separator offline (e.g., roadway intersections), try to minimize the size of the area requiring oil control, and use the on-line water quality design flow rate (refer to *Section 4.2.1*).
- Oil/water separators shall not be used for removal of dissolved or emulsified materials such as coolants, soluble lubricants, glycols (anti-freeze), and alcohols.
- Oil/water separators are best located in areas where the contributing drainage area is nearly all impervious and a fairly high load of TPH is likely to be generated.
- Excluding unpaved areas helps to minimize the amount of sediment entering the vault, which reduces the need for maintenance. Pretreatment should be considered if the level of total suspended solids (TSS) in the inlet flow would cause clogging or otherwise impair the long-term efficiency of the separator.

The following considerations can influence the feasibility of CP separators for a particular site:

- CP separators are typically smaller than API separators and are suitable for sites where space is limited.
- CP separator designs may be required to add pretreatment for TSS that could cause clogging of the CP separator, or otherwise impair the long-term effectiveness of the separator.
- Typical applications of CP oil/water separators include inflows from small contributing drainage areas (fueling stations, maintenance shops, etc.) due to space limitations. However, if plugging of the plates is likely, then a new design basis for the baffle type API separator may be considered on an experimental basis.

Additional site considerations may apply depending on site conditions and other factors.

5.8.10.5. Design Criteria

The following provides a description and requirements for the components of oil/water separators. Some or all of the components may be used for a given application depending on the site characteristics and restrictions, pollutant loading, and design objectives. Design criteria are provided in this section for the following elements:

- Vault geometry
- Vault structure
- Baffles
- Separator plates
- Material requirements
- Inlet and outlet
- Access

Note: The following criteria apply to both API baffle and CP separators, unless otherwise specified.

Vault Geometry

Oil/water separator vaults are typically divided in three compartments: a forebay, an oil separation cell, and an afterbay:

- The length of the forebay shall be a minimum of 0.33 the length of the vault (L), but 0.5 L is recommended.
- The surface area of the forebay shall be at least 20 square feet per 10,000 square feet of tributary impervious area draining to the separator.
- The forebay is designed primarily to trap and collect sediment and debris, support plug flow conditions, and reduce turbulence.
- The oil separation cell traps and holds oil as it rises from the water column, and it serves as a secondary sediment collection area.
- The afterbay provides a relatively oil-free cell before the outlet and provides a secondary oil separation area.

The following criteria apply specifically to API separator bay vaults (Figure [5.335-28](#)):

- The design water depth shall be no deeper than 8 feet unless approved by the Director. Depths greater than 8 feet may be permitted on a case-by-case basis, taking into consideration the potential for depletion of oxygen in the water during the warm summer months.
- Baffle separator vaults shall have a minimum length-to-width ratio of 5:1.
- Baffle separator vaults shall have a design water depth-to-width ratio of between 0.3 and 0.5.

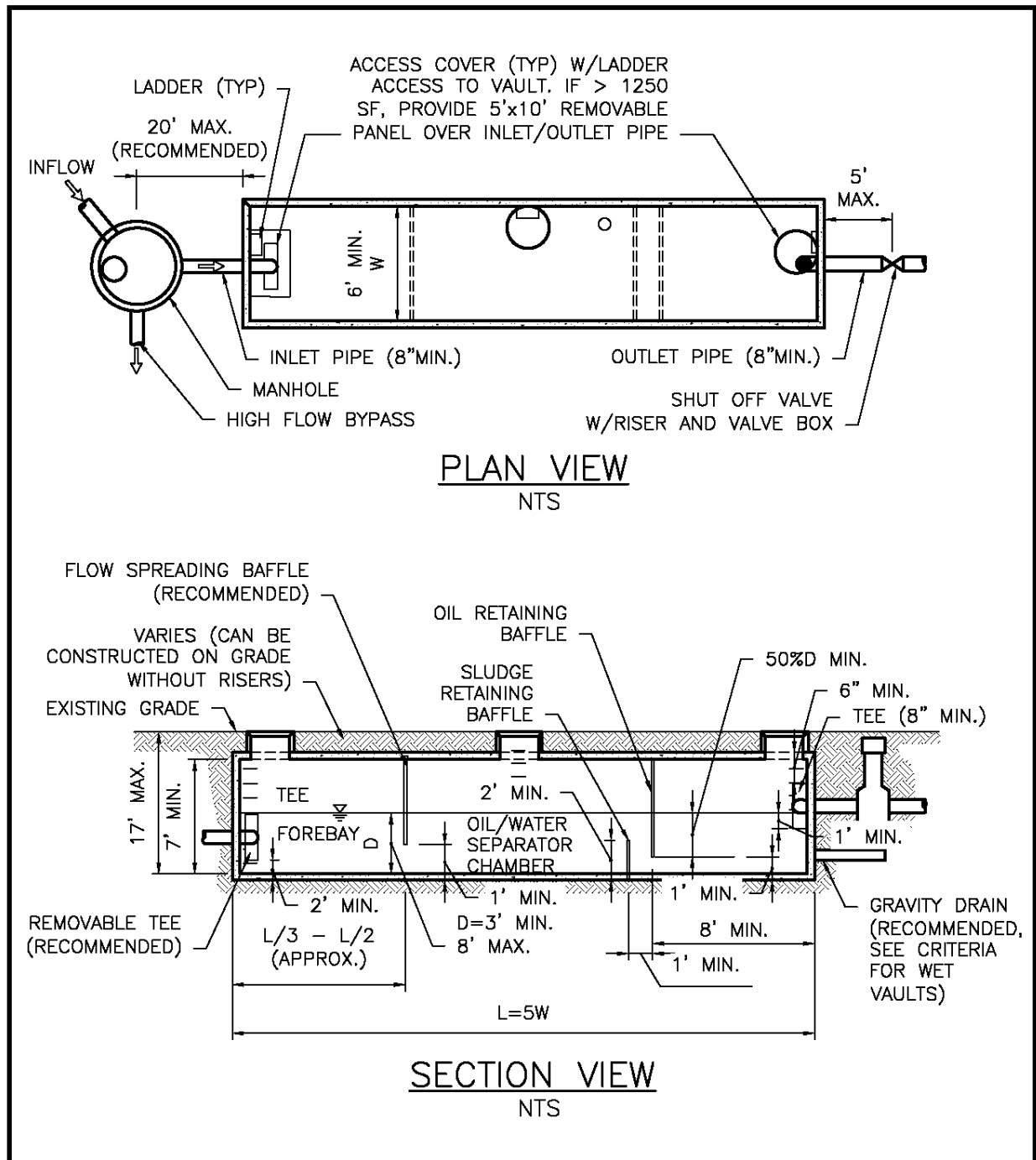

Figure 5.335-28. Typical API (Baffle Type) Separator.

The following criteria apply specifically to CP separators (Figure 5.345-29):

- In lieu of an attached forebay, a separate grit chamber, sized to be at least 20 square feet per 10,000 square feet of tributary impervious area, may precede the oil/water separator.

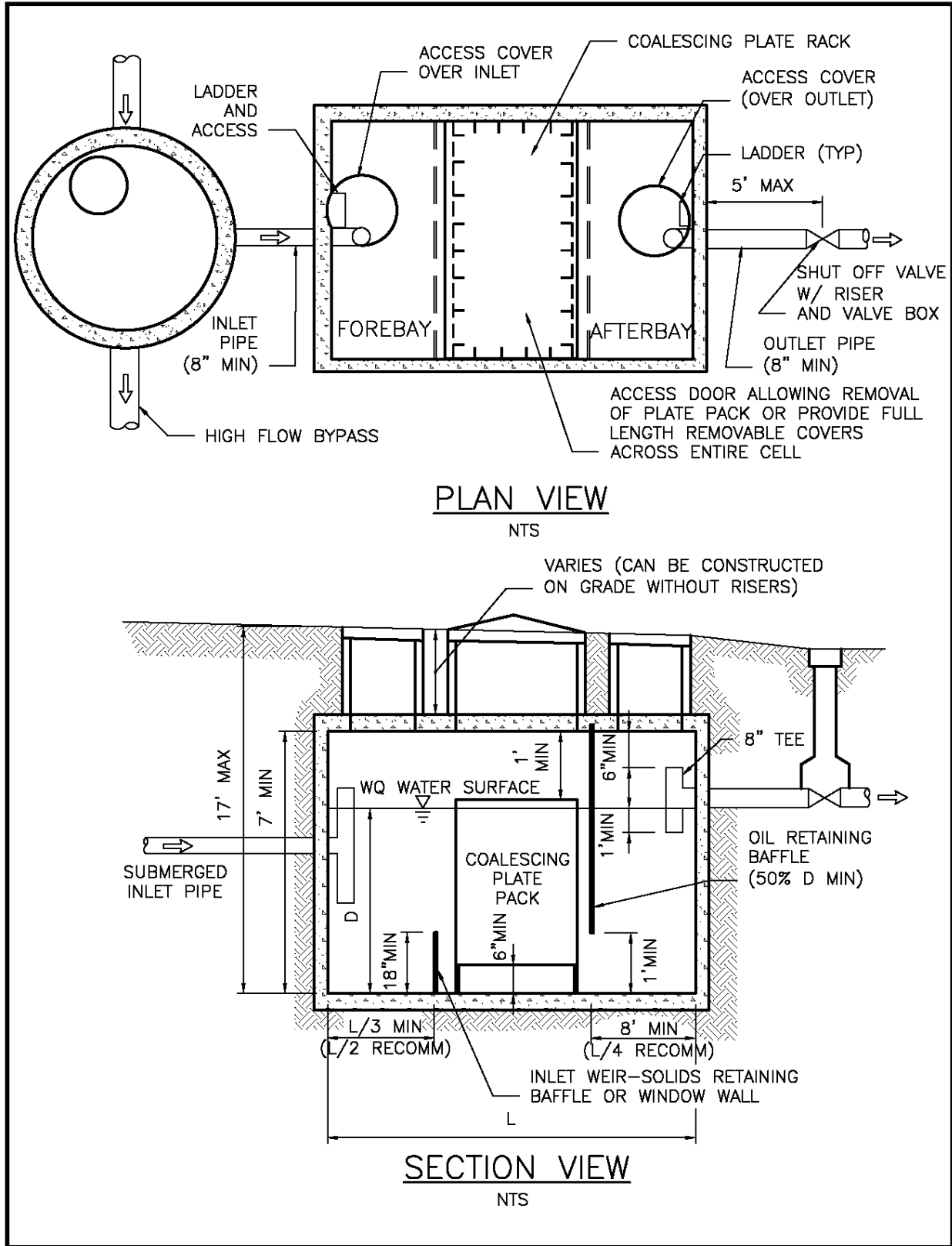

Figure 5.345-29. Typical Coalescing Plate Separator.

Vault Structure

The following criteria apply to both API and CP separator bays:

- Separator vaults shall be watertight.
- Separator vaults shall have a shutoff mechanism on the outlet pipe to prevent oil discharges during maintenance and to provide emergency shutoff capability in the event of a spill. A valve box and riser shall be provided.
- Roughing screens for the forebay or upstream of the separator to remove debris, should be used if needed. Screen openings should be approximately 0.75 inch.
- A gravity drain for maintenance is recommended if grade allows. The drain invert should be at a depth equal to the depth of the oil retaining baffle. Deeper drains are encouraged where feasible.
- If large amounts of oil are likely to be captured, a bleed-off pipe and separate waste oil tank can be located adjacent to the vault to channel separated oils into the tank. This improves the overall effectiveness of the facility, especially if maintenance is only performed annually. It also improves the quality of the waste oil recovered from the facility.
- Absorbents and/or skimmers should be used in the afterbay.

Baffles

The following criteria apply specifically to API separator bay vaults:

- A removable flow-spreading baffle, extending from the surface to a depth of up to half of the vault depth (D) is recommended to spread flows. Design guidelines for level spreaders are provided in *Appendix E*.
- A removable oil retaining baffle shall be provided and located approximately one-quarter of the distance from the outlet wall or a minimum of 8 feet, whichever is greater (the 8-foot minimum is for maintenance purposes). The oil-retaining baffle shall extend from the elevation of the water surface to a depth of at least 50 percent of the design water depth and at least 1 foot from the separator bottom. Various configurations are possible, but the baffle shall be designed to minimize turbulence and entrainment of sediment.
- The removable bottom baffle (sediment-retaining baffle) shall be a minimum of 24 inches, and located at least 1 foot from the oil-retaining baffle. A “window wall” baffle may be used, but the area of the window opening shall be at least three times greater than the area of the inflow pipe.
- Baffles may be fixed rather than removable if additional entry ports and ladders are provided so that both sides of the baffle are accessible by maintenance crews.
- Baffle height to water depth ratios should be 0.85 for top baffles and 0.15 for bottom baffles.

The following criteria apply specifically to CP separators:

- An oil-retaining baffle shall be provided. For large units, a baffle position of one-quarter of the distance from the outlet wall is recommended. The oil-retaining baffle shall extend from the water surface to a depth of at least 50 percent of the design water depth and at least 1 foot from the separator bottom. Various configurations are possible, but the baffle shall be designed to minimize turbulence and entrainment of sediment.

- A bottom sediment-retaining baffle shall be provided upstream of the plate pack. The minimum height of the sludge-retaining baffle shall be 18 inches. Window walls may be used, but the window opening shall be a minimum of three times greater than the area of the inflow pipe.

Coalescing Plate Separators

The following criteria apply specifically to CP separators:

- Plates shall be inclined at 45 to 60 degrees from the horizontal. This range of angles exceeds the angle of repose of many solids, and therefore, provides more effective droplet separation while minimizing the accumulation of solids on the individual plates.
- Plates shall have a minimum spacing of 0.5-inch and have corrugations.
- Plates shall be securely bundled in a plate pack for ease of removal and cleaning (with high-pressure rinse or equivalent).
- The plate pack shall be a minimum of 6 inches from the vault bottom for sediment storage.
- There should be 1 foot of head space between the top of the plate pack and the bottom of the vault cover.

Material Requirements

The following guidelines apply when selecting oil/water separator materials:

- Vault baffles shall be concrete, stainless steel, fiberglass reinforced plastic, or another acceptable material, and shall be securely fastened to the vault.
- The following criteria applies specifically to CP separators:
 - Plate packs shall be made of fiberglass, stainless steel, or polypropylene, unless otherwise recommended by the manufacturer and approved by the Director.
 - The entire space between the sides of the plate pack and the vault wall shall be filled with a solid but light-weight removable material such as a plastic or polyethylene foam to reduce short-circuiting around the plate pack. Rubber flaps are not effective for this purpose.

Inlet and Outlet

The following inlet and outlet criteria apply to both types of oil/water separators:

- The separator inlet shall be submerged. A tee section may be used to submerge the incoming flow and shall be at least 2 feet from the bottom of the tank and extend above the water quality design water surface.
- The submerged inlet is to dissipate energy of the incoming flow. The distance from the bottom is to minimize resuspension of settled sediments. Extending the tee to the surface allows air to escape the flow, thus reducing turbulence. Alternative inlet designs that accomplish these objectives are acceptable.
- The vault outlet pipe shall be sized to pass the water quality design flow before overflow. The vault outlet pipe shall be back-sloped or have a tee extending 1 foot above and below the water quality design water surface to provide for secondary trapping of oils and floatables in the wet vault. Note: The invert of the outlet pipe sets the water quality design water surface elevation.

Access Requirements

Access requirements are the same as for wet vaults (*Section 5.8.7.5*).

The following access requirements also apply for CP separators:

- Access to the compartment containing the plate pack shall be a removable panel or other access able to be opened wide enough to remove the entire coalescing plate bundle from the cell for cleaning or replacement. Doors or panels shall have stainless steel lifting eyes, and panels shall weigh no more than 5 tons per panel.
- A parking area or access pad (25-foot by 15-foot minimum) shall be provided near the coalescing plate bundles to allow for their removal from the vault by a truck-mounted crane or backhoe, and to allow for extracting accumulated solids and oils from the vault using a Vactor truck.

5.8.10.6. BMP Sizing

For offline separators, the high flow bypass shall be designed so that all flows up to and including the water quality design flow rate are directed to the separator. Design guidelines for flow splitters are provided in *Appendix E*. The water quality design flow rate is calculated by multiplying the design flow rate determined using an approved continuous simulation model by the offline ratio of 3.0. For on-line separators, the water quality design flow rate is calculated by multiplying the flow rate determined using an approved continuous simulation model by the on-line ratio of 1.65. Separators shall be designed as offline facilities wherever possible.

The API and CP sizing method is based on the horizontal velocity of the bulk fluid (V_h), the oil rise rate (V_t), the residence time (t_m), width, depth, and length considerations as follows:

1. Determine the oil rise rate, V_t , ~~in cm/sec,~~ using Stokes' Law (Water Pollution Control Federation 1985) or empirical determination. Stokes Law assumes that flow is laminar and that oil droplets are spherical shaped. Stokes Law equation for rise rate, V_t (ft/min):

$$V_t = [1.97 * g * (\sigma_w - \sigma_o) * D^2] / (18 * \eta_w)$$

Where:

$$V_t = \text{oil rise rate (cm/sec)}$$

1.97 = conversion factor (cm/sec to ft/min)
 g = gravitational constant (981 cm/sec²)
 D = diameter of the oil particle (cm)
 σ_w = water density in grams per cubic centimeter (gm/cc) at 32°F
 σ_o = oil density
 η_w = dynamic viscosity of water (gm/cm-sec) at water temperature of 32°F, (Refer to American Petroleum Institute 1990)

Use:

$$g = 981 \text{ cm/sec}^2$$

$$\begin{aligned}
 D &= 60 \text{ microns (0.006 cm)} \\
 \sigma_w &= 0.999 \text{ gm/cc at } 32^\circ\text{F} \\
 \sigma_o &= \text{Select conservatively high oil density. For example, if} \\
 &\text{diesel oil @ } \sigma_o = 0.85 \text{ gm/cc and motor oil @ } \sigma_o = 0.90 \text{ gm/cc can be} \\
 &\text{present then use } \sigma_o = 0.90 \text{ gm/cc} \\
 \eta_w &= 0.017921 \text{ gm/cm-sec}
 \end{aligned}$$

2. Determine Q:

Q = the 15-minute Water Quality design flow rate in ft³/min multiplied by the offline facility ratio of 3.0. Note that some continuous hydrologic models give the water quality design flow rate in ft³/sec. Multiply this flow rate by 60 to obtain the flow rate in ft³/min.

3. Calculate horizontal velocity of the bulk fluid, V_h (in ft/min) and water depth in separator (d) in feet.

$$\begin{aligned}
 V_h &= 15V_t \\
 d &= (Q/2V_h)^{0.51/2}
 \end{aligned}$$

Note: Separator water depth (d) shall be: $3 \leq d \leq 8$ feet to minimize turbulence (American Petroleum Institute 1990; US Army Corps of Engineers 1994). If the calculated depth is less than 3 feet, an API separator is not appropriate for the site. If the calculated depth exceeds 8 feet, consider using two separators.

4. Calculate the minimum residence time (t_m), in minutes, of the separator at depth d:

$$t_m = d/V_t$$

5. Calculate the minimum length of the separator section, l(s):

$$l(s) = (F * Q * t_m) / (w * d) = F * (V_h/V_t) * d$$

Where:

$$F = 1.65$$

Use depth/width (d/w) ratio of 0.5 (American Petroleum Institute 1990)

For other dimensions, including the length of the forebay, the length of the afterbay, and the overall length, L; refer to Figure 5.345-29.

6. Calculate $V = l(s) * w * d = F * Q * t_m$, and $A_h = w * l(s)$

$$\begin{aligned}
 V &= \text{minimum hydraulic design volume (cubic feet)} \\
 A_h &= \text{minimum horizontal area of the separator (square feet)}.
 \end{aligned}$$

CP separators follow the same sizing method as API separators. Calculate the projected (horizontal) surface area of plates needed using the following equation:

$$A_p = Q/V_t = Q/[0.00386 * (\sigma_w - \sigma_o/\eta_w)]$$

$$A_p = A_a(\cosine b)$$

Where:

- A_p = projected surface area of the plate in (ft²); 0.00386 is unit conversion constant
- Q = the on-line (1.65) or offline (3.0) adjustment factor x the 15-minute water quality design flow rate, (ft³/min)
- V_t = Rise rate of 0.033 ft/min, or empirical determination, or Stokes Law based
- σ_w = density of water at 32°F
- σ_o = density of oil at 32°F
- A_a = actual plate area in (ft²) (one side only)
- b = angle of the plates with the horizontal in degrees (usually varies from 45 to 60 degrees)
- η_w = viscosity of water at 32°F.

5.8.10.7. Minimum Construction Requirements

The following are construction requirements associated with the construction of an oil/water separator:

- Follow the manufacturer's recommended construction procedures and installation instructions, as well as any applicable City requirements.
- Upon completion of installation, thoroughly clean and flush the oil/water separator prior to operation.
- Specify appropriate performance tests after installation and shakedown, and/or provide certification by a licensed engineer that the separator is functioning in accordance with design objectives.

5.8.10.8. Operations and Maintenance Requirements

Oil/water separator O&M requirements are provided in *Appendix G (BMP No. 18 and 19)*.

5.8.11. Proprietary and Emerging Water Quality Treatment Technologies

This section describes how the City will evaluate the use of proprietary and emerging water quality treatment technologies.

5.8.11.1. Description

To receive Ecology approval for use in stormwater applications in Washington, new technologies shall be evaluated following Ecology's technology assessment protocols (TAPE and CTAPE), which establish guidelines for evaluating the performance of water quality treatment technologies in achieving different levels of performance (i.e., pretreatment, basic, enhanced, phosphorus, oil). The evaluation process requires manufacturers to field test the performance of new water quality treatment technologies. After the successful completion of field testing, the ~~vendor~~ [manufacturer](#) submits a technology evaluation report (TER) to Ecology for review and approval. Information about Ecology's evaluation process can be found at the following website (<https://ecology.wa.gov/Regulations-Permits/Guidance-technical-assistance/Stormwater-permittee-guidance-resources/Emerging-stormwater-treatment-technologies>~~www.ecy.wa.gov/programs/wq/stormwater/newtech/index.html~~).

Under the technology assessment process, Ecology assigns "Use Level Designations" to emerging technologies based on the results of the TAPE and CTAPE evaluation. Ecology establishes the use level for each technology and its associated performance level based on the relevance, amount, and quality of performance data available as defined below:

- **GULD – General Use Level Designation:** A General Use Level Designation (GULD) is assigned to technologies for which the performance monitoring demonstrates with a sufficient degree of confidence, that the technology is expected to achieve Ecology's performance goals. Use is subject to conditions, including design restrictions and sizing, documented in a use level designation letter prepared by Ecology.
- **CULD – Conditional Use Level Designation:** A Conditional Use Level Designation (CULD) is assigned to technologies that have considerable performance data not collected per the TAPE protocol. Ecology will allow the use of technologies that receive a CULD for a specified time, during which performance monitoring shall be conducted and a TER submitted to Ecology. Units that are in place do not have to be removed after the specified time period. Use is subject to conditions, including design restrictions and sizing, documented in a use level designation letter prepared by Ecology.
- **PULD – Pilot Use Level Designation:** A Pilot Use Level Designation (PULD) is assigned to new technologies that have limited performance monitoring data or that only have laboratory performance data. The PULD allows limited use of the technology to allow performance monitoring to be conducted. PULD technologies may be installed provided that the ~~vendor~~ [manufacturer](#) and/or developer agree to conduct performance monitoring per the TAPE protocol at all installations. Use is subject to conditions, including design restrictions and sizing, documented in a use level designation letter prepared by Ecology.

5.8.11.2. Performance Mechanisms

Ecology (2018~~2011~~) has established different performance goals for water quality treatment technologies based on the types of pollutants that they are effective in removing and their applicable use for water quality treatment. Proprietary technologies use a wide variety of mechanisms to achieve these performance goals. This section has further information on a small sub-set of proprietary technologies that have achieved a GULD designation using primarily filtration and adsorption.

5.8.11.3. Applicability and Restrictions

The following subset of ~~four~~ TAPE approved proprietary technologies have been evaluated by the City and sized for annual maintenance and can be applied to meet or partially meet the requirements listed below. [Note: Some manufacturers have multiple media blends available, not all of which have received GULD approval.](#) Other proprietary technologies may be applicable, refer to ~~the~~ Ecology's TAPE web [page](#)site.

BMP	On-site		Flow Control			Water Quality				Conveyance
	List	Standard	Forest	Pasture	Peak	Basic	Enhanced	Oil Control	Phosphorus	
BayFilter® (Silica sand, perlite, activated alumina media)						✓				
Filterra®						✓	✓	✓	✓	
FloGard Perk Filter® (Zeolite, perlite, carbon media)						✓			✓	
Stormwater Management StormFilter (StormFilter)® (Zeolite, perlite, granular activated carbon media)						✓				
MWS-Linear Modular Wetland®						✓	✓		✓	
BioPod®						✓	✓		✓	
Kraken®						✓			✓	

Note: Hydraulic conductivity differs from sizing for basic treatment, Use the lowest applicable hydraulic conductivity when sizing.

The Director will accept technologies approved by Ecology as described below:

- GULD technologies for use on parcels will be accepted subject to the conditions of use established by in the use level designation established by Ecology and sized for mass loading targeting annual maintenance. Use in the right-of-way is subject to approval by SPU and early consultation is encouraged. Not all GULD approved BMPs will be acceptable.
- CULD technologies will be accepted on a limited basis provided that the project owner signs an agreement with the City stating that the owner will modify/upgrade the

system in accordance with any conditions that Ecology may require as part of the final GULD designation and sized for mass loading targeting annual maintenance. The owner shall also file annual reports as outlined by the City.

- PULD technologies will be accepted on a limited basis to enable manufacturers to obtain data to help fulfill the requirements of the TAPE protocol. These projects shall be approved in advance by the Director of SPU, be sized for mass loading targeting annual maintenance and have an approved monitoring plan reviewed by Ecology, and provide a financial bond to provide clean-up and replacement in the event of failure.

5.8.11.4. Site Considerations

Site considerations for the Filterra® system installation are primarily regarding grading and landscaping. For grading, both the flow entrance to the Filterra® and bypass to a catch basin are important considerations and need to be analyzed together. Landscaping within the Filterra® system shall be from the approved list. Either the box or Filterra Bioscape® systems may be used.

[Site considerations for the MWS-Linear Modular Wetland® are dependent on grading, hydraulics, and landscaping. Landscaping within the MWS-Linear Modular Wetland® system shall be from the approved list. The pretreatment chamber access shall be accessible for replacement of the pretreatment filters.](#)

Site considerations for the filter cartridge systems ([e.g., BayFilter®, FloGard Perk Filter®, StormFilter®](#)) are primarily hydraulic and how to select cartridges, group cartridges and in which kind of structure. Multiple cartridges in a maintenance hole or vault will most likely be easier to remove and replace. Vaults, maintenance hole and catch basin installations and stacked or unstacked cartridges may be allowed. Within the right-of-way, maintenance hole and vault installation are preferred. Multiple heights of cartridge systems and required heads for filter function are available. Backwater conditions may restrict the use of these technologies and both the structure elevations and anticipated water surface elevations of the surrounding drainage system shall be considered.

No specific setbacks or restrictions apply to closed bottom facilities. The following setbacks and restrictions apply to open bottom facilities.

- All open bottom facilities shall be a minimum of 50 feet from the top of any steep (greater than 40 percent) slope. A geotechnical analysis and report shall be prepared addressing the potential impact of the open bottom facility on a slope steeper than 15 percent.
- The water surface at the outlet invert elevation shall be set back 100 feet from existing septic system drain fields. This setback may be reduced with written approval of Public Health – Seattle & King County.

5.8.11.5. Design Criteria

In addition to the manufacturer's design criteria and the conditions of use in Western Washington required by Ecology, Seattle has adopted design criteria on piping and access and manufacturer review.

Piping

Inlet, outlet and interior piping shall have a minimum size of 6 inches. To the extent feasible, piping should be straight with as few bends and turns as possible to reduce headloss and minimize the potential for sediment to accumulate in the piping system.

Access

Access for lifting equipment to remove and replace filter cartridges is required. For filter cartridge systems in a vault or maintenance hole configuration where individual cartridges are not directly below the lid or cover of the structure, a plan for the safe removal and replacement is required.

Manufacturer Review

Design review with the manufacturer of the proprietary technology is required to check grading and variables that are specific to the proposed installation. Sizing requirements in *Section 5.8.11.6* are in addition to the manufacturer's requirements.

5.8.11.6. BMP Sizing

The City has developed sizing criteria for a subset of the proprietary treatment systems that are most commonly used in Seattle. The sizing criteria are based on a target level of once-a-year maintenance to ensure meeting the operations and maintenance requirements established in the Ecology use level designations for each technology. Facilities would not be inspected multiple times during the first year as required by TAPE, but would be designed to perform for 1 year under normal circumstances before maintenance is required.

The sizing criteria were developed using information from each manufacturer regarding how much solid material can be removed before the hydraulic capacity of their system is reduced to the point where it can no longer treat the required design storm without bypassing flow. Solids loading capacity information is fairly limited and each [vendor-manufacturer](#) uses different methods to evaluate. In the absence of standardized testing protocols, the City has used data currently available from the [vendors/manufacturers](#). TSS loading was as shown in Table 3.5. It is anticipated that sizing criteria may be modified as more [vendor-manufacturer](#) testing information becomes available in the future.

For the subset of proprietary technologies in *Section 5.8.11.3*, application of the mass loading ratios will satisfy these requirements for basic treatment. For requirements other than basic treatment, or for other proprietary technologies, separate calculations demonstrating that they meet the annual maintenance goal for mass loading typical for the land use in Seattle are required.

Step 1: Determine the water quality design flow rate

Use an approved continuous model to determine the on-line water quality design flow rate using the following assumptions.

Variable	Assumption
Precipitation Series	Seattle 158-year, 5-minute series
Computational Time Step	15 minutes
HSPF Parameters	LSUR, SLSUR, NSUR shall be adjusted per Appendix F
Inflows to Facility	Surface flow from total drainage area (including impervious and pervious contributing areas) routed to facilities.

Step 2: Adjust the water quality design flow rate

For basic treatment requirements for the subset of proprietary technologies in *Section 5.8.11.3*, adjust the water quality design flow rate using the mass loading ratios below. Multiply the flow rate determined in Step 1 by the mass loading ratio.

Zoning Categories	Mass Loading Ratios ^{a,b}				
	Filter Cartridge Systems^c	Vertical Flow Media Filter Systems^d			
<ul style="list-style-type: none"> Parcels zoned as SFR or MFR Non-arterial streets adjacent to properties zoned as SFR or MFR 	2.54-0	1.64-0	2-0	3-0	4-0
<ul style="list-style-type: none"> Parcels zoned as neighborhood/commercial, downtown, major institutions, master planned community, or residential/commercial Arterial streets with adjacent property zoned as neighborhood/commercial, downtown, major institutions, master planned community, or residential/commercial 	2.64-0	1.64-0	2-0	3-5	4-0
<ul style="list-style-type: none"> Parcels zoned as manufacturing/industrial Non-arterial or arterial streets with adjacent property zoned as manufacturing/industrial 	3.76-0	2.34-0	3-0	4-5	4-5

^a Mass loading ratios were developed for this limited set of proprietary technologies using a mean total suspended solids concentration ([Refer to See Table 3.5](#)) and assumed use of an [on-line/offline](#) water quality design flow rate. Use of this table is restricted to uses that match those assumptions. For other proprietary technologies, or other assumptions, [refer to see Section 3.5-BMP Selection for Water Quality Treatment](#).

^b [When applicable, designer shall round up to the nearest whole cartridge or next largest vault size.](#)

^c [Filter cartridge systems approved for use in the City of Seattle include:](#)

- [BayFilter® \(BaySaver\)](#)
- [FloGard PerkFilter® \(Oldcastle\)](#)
- [Kraken® \(Bio Clean Forterra\)](#)
- [MWS-Linear Modular Wetland® \(Bio Clean Forterra\)](#)
- [StormFilter® \(Contech\)](#)

^d [Vertical flow media filter systems approved for use in the City of Seattle include:](#)

[BioPod® \(Oldcastle\)](#)

[Filtterra® \(Contech\)](#)

Step 3: Determine the allowable water quality design flow rate

Determine the allowable flow rate for the specific proprietary technology, specific configuration and size proposed to meet the requirements as described in the Ecology GULD table conditions of use.

Step 4: Select the size of facility or number of cartridges

Use the modified design flow rate from Step 2 to select the size of facility or number of cartridges needed. Round up as necessary.

5.8.11.7. Minimum Construction Requirements

The following are construction requirements with the construction of proprietary technologies:

- Follow the manufacturer's recommended construction procedures and installation instructions as well as any applicable City requirements.
- Follow the manufacturer's requirements for flow rate restrictions (orifice).
- Protect the media filter systems from construction flows. Thoroughly clean structures and replace media or media cartridges if impacted from construction flows.

5.8.11.8. Operations and Maintenance Requirements

Refer to Ecology's website and the manufacturer's website for facility-specific maintenance requirements (<https://ecology.wa.gov/Regulations-Permits/Guidance-technical-assistance/Stormwater-permittee-guidance-resources/Emerging-stormwater-treatment-technologies>www.ecy.wa.gov/programs/WQ/stormwater/newtech/technologies.html).

O&M requirements for proprietary technology ~~filter~~ cartridge ~~type filter~~ systems (e.g., Bay Filter®, FloGard Perk Filter®, and ~~Stormwater Management StormFilter~~ [StormFilter]®), and the ~~proprietary technology~~ Filtterra® system, and MWS-Linear Modular Wetland® are included in *Appendix G (BMP No. 17, and 21, and 22)*. BMPs sized using the mass loading ratios as required in *Section 5.8.11.6* are not required to inspect the facility multiple times during the first year of operation or develop a site-specific inspection/maintenance schedule as indicated in the Ecology GULD approval. Annual maintenance, including filter cartridge replacement as needed is required.

CHAPTER 6 – REFERENCES

[DeOreo, B., and P. Mayer. 2012. Residential End Uses of Water: Progress Report and Interim Results. Drinking Water Research. July-September 2012.](#)

[Ecology. 2006. Guidance for UIC Wells that Manage Stormwater. Publication No. 05-10-067. Prepared by the Washington State Department of Ecology, Olympia, Washington. December 2006.](#)

Ecology. [20182014](#). Technical Guidance Manual for Evaluating Emerging Stormwater Treatment Technologies: Technology Assessment Protocol – Ecology (TAPE). Publication No. [18-10-03811-10-061](#). Prepared by the Washington State Department of Ecology, Olympia, Washington. [September 2018August 2014](#).

Ecology. [20192012](#). Stormwater Management Manual for Western Washington. [5 vols.](#) Publication No. [19-10-02114-10-055 \(a revision of Publication No. 12-10-030\)](#). Prepared by the Washington State Department of Ecology, Olympia, Washington. [July 2019August 2012, revised in December 2014](#).

Public Health – Seattle & King County. 2011. Rainwater Harvesting and Connection to Plumbing Fixtures. Document Code No. Product/Method #10-004 (replaces #07-001). January 25, 2011.

Seattle. [20172012](#). [Seattle Streets Illustrated, the](#) Right-of-Way Improvements Manual. [SDOT/SDCI Director’s Rules 04-2017/31-2017](#).

SPU. 2015. City of Seattle. Protecting Seattle’s Waterways. Volume 3 – Final Integrated Plan. Appendix F: Pollutant Reduction Estimation Method – Candidate Stormwater Projects. May 29, 2015.

Stenn, H., et al. [20182012](#). Building Soil: Guidelines and Resources for Implementing Soil Quality and Depth BMP T5.13 [in WDOE Stormwater Management Manual for Western Washington](#). [5th edition](#). Available online at www.buildingsoil.org.

[WRF. 2016. Residential End Uses of Water Executive Report, Version 2. Water Research Foundation. April 2016.](#)

WSDOT. [20202014](#). Washington State Department of Transportation Standard Specifications for Road, Bridge, and Municipal Construction, [20202014](#). Publication No. M 41-10. Prepared by Washington State Department of Transportation. [September 2020January 2014](#).

WSU. 2012. Low Impact Development Technical Guidance Manual for Puget Sound.

WSU. 2013. Rain Garden Handbook for Western Washington Homeowners. Prepared by the Pierce County Extension of Washington State University, Puyallup, Washington.

This page intentionally left blank.

**THIS COVER TO BE REPLACED
WITH SPU-PROVIDED COVER**

**VOLUME 4 —
SOURCE CONTROL**

**CITY OF SEATTLE
SEATTLE PUBLIC UTILITIES
DEPARTMENT OF CONSTRUCTION AND INSPECTIONS**

July 2021

Note:

Some pages in this document have been purposely skipped or blank pages inserted so that this document will copy correctly when duplexed.

Table of Contents

CHAPTER 1 - Introduction.....	1-1
1.1. What Is the Purpose of This Volume?	1-1
1.2. How Does this Volume Apply to Businesses and Properties?.....	1-1
1.3. Which Pollutants Are Targeted in This Volume?.....	1-2
1.3.1. pH.....	1-2
1.3.2. Total Suspended Solids	1-2
1.3.3. Chemical and Biological Oxygen Demanding Substances.....	1-2
1.3.4. Metals	1-2
1.3.5. Bacteria and Viruses	1-3
1.3.6. Nutrients.....	1-3
1.3.7. Toxic Organic Compounds.....	1-3
1.3.8. Other Chemicals and Substances	1-3
1.3.9. Oils and Greases.....	1-3
1.3.10. Soaps and Detergents.....	1-3
1.4. What Are BMPs?.....	1-4
1.4.1. Source Control BMPs	1-4
1.4.2. Treatment BMPs	1-4
1.5. Already Implementing Best Management Practices?.....	1-5
1.6. Getting Started	1-5
CHAPTER 2 - Best Management Practices for All Real Property	2-1
2.1. Required Best Management Practices.....	2-1
2.1.1. BMP 1: Eliminate Illicit Connections and Illicit Discharges	2-2
2.1.2. BMP 2: Perform Routine Maintenance.....	2-3
2.1.3. BMP 3: Dispose of Fluids and Wastes Properly	2-4
2.1.4. BMP 4: Proper Storage of Solid Wastes	2-5
2.1.5. BMP 5: Spill Prevention and Cleanup.....	2-7
2.1.6. BMP 6: Provide Oversight and Training for Staff	2-10
2.1.7. BMP 7: Property Maintenance	2-11
2.1.8. BMP 8: Rooftop Dog Runs	2-12
2.2. Required Best Management Practices for Specific Activities.....	2-13
2.2.1. BMP 9: Fueling at Dedicated Stations	2-14
2.2.2. BMP 10: Mobile Fueling of Vehicles and Heavy Equipment	2-20
2.2.3. BMP 11: In-Water and Over-Water Fueling.....	2-22
2.2.4. BMP 12: Maintenance and Repair of Vehicles and Equipment.....	2-23
2.2.5. BMP 13: Concrete and Asphalt Mixing and Production	2-25
2.2.6. BMP 14: Concrete Pouring, Concrete/Asphalt Cutting, and Asphalt Application	2-28
2.2.7. BMP 15: Recycling, Wrecking Yard, and Scrap Yard Operations	2-30
2.2.8. BMP 16: Storage of Liquids in Aboveground Tanks.....	2-33

CHAPTER 3 – Business and Public Entity Best Management Practices for Specific Activities	3-1
3.1. Cleaning or Washing	3-2
3.1.1. BMP 17: Cleaning or Washing	3-3
3.2. Transfer of Liquid or Solid Materials	3-7
3.2.1. BMP 18: Loading and Unloading of Liquid or Solid Material	3-8
3.3. Production and Application	3-13
3.3.1. BMP 19: Manufacturing and Post-Processing of Metal Products	3-16
3.3.2. BMP 20: Processing of Treated Wood	3-18
3.3.3. BMP 21: Commercial Composting	3-20
3.3.4. BMP 22: Landscaping and Vegetation Management	3-22
3.3.5. BMP 23: Painting, Finishing, and Coating Activities	3-26
3.3.6. BMP 24: Commercial Printing Operations	3-28
3.3.7. BMP 25: Manufacturing Activities	3-29
3.4. Storage and Stockpiling	3-31
3.4.1. BMP 26: Storage of Leachable or Erodible Materials	3-32
3.4.2. BMP 27: Temporary Storage or Processing of Fruits, Vegetables, or Grains	3-36
3.4.3. BMP 28: Portable Container Storage	3-38
3.5. Dust, Soil Erosion, and Sediment Control	3-42
3.5.1. BMP 29: Dust Control in Disturbed Land Areas and on Unpaved Roadways and Parking Lots	3-43
3.5.2. BMP 30: Dust Control at Manufacturing Sites	3-44
3.5.3. BMP 31: Soil Erosion and Sediment Control at Industrial Facilities	3-45
3.6. Other Activities	3-46
3.6.1. BMP 32: Commercial Animal Care and Handling	3-47
3.6.2. BMP 33: Log Sorting and Handling	3-48
3.6.3. BMP 34: Boat Building, Maintenance, and Repair	3-49
3.6.4. BMP 35: Cleaning and Maintenance of Pools, Spas, Hot Tubs, and Fountains	3-51
3.6.5. BMP 36: Deicing and Anti-icing Operations for Airports and Streets	3-52
3.6.6. BMP 37: Maintenance and Management of Roof and Building Drains at Industrial and Commercial Buildings	3-54
3.6.7. BMP 38: Maintenance and Operation of Railroad Yards	3-55
3.6.8. BMP 39: Maintenance of Public and Private Utility Corridors and Facilities	3-57
3.6.9. BMP 40: Maintenance of Roadside Ditches	3-59
3.6.10. BMP 41: Potable Water Line Flushing, Water Tank Maintenance, and Hydrant Testing	3-61
3.6.11. BMP 42: Urban Streets	3-62
3.6.12. BMP 43: Nurseries and Greenhouses	3-63
3.6.13. BMP 44: Color Events	3-64
3.6.14. BMP 45: Pet Waste	3-65
3.6.15. BMP 46: Labeling Storm Drain Inlets on Your Property	3-66
3.6.16. BMP 47: Well, Utility, Directional, and Geotechnical Drilling	3-67

3.6.17. BMP 48: Goose Waste3-68
3.6.18. BMP 49: Pesticides and an Integrated Pest Management Program3-69
3.6.19. BMP 50: Storage of Dry Pesticides and Fertilizers3-70
3.6.20. BMP 51: Irrigation3-71
3.6.21. BMP 52: Dock Washing3-72
3.6.22. BMP 53: Roof Vents3-73
3.6.23. BMP 54: Streets and Highways3-74
3.6.24. BMP 55: Fertilizer Application.....3-75
CHAPTER 4 - References 4-1

Tables

Table 1.	Worksheet for Identifying Applicable BMPs.....	1-7
----------	--	-----

Figures

Figure 1.	Covered Outdoor Storage of Solid Wastes.	2-5
Figure 2.	Waste Storage Area with Spill Kit and Posted Spill Plan.....	2-8
Figure 3.	Fueling Island Schematic.	2-15
Figure 4.	Roof at Fueling Island to Prevent Stormwater Run-On.	2-17
Figure 5.	Commercially Available Catch Basin Filter Sock.	2-26
Figure 6.	Car Wash Building with Drain to the Sanitary Sewer.....	3-4
Figure 7.	Schematic of Wash Pad with Sump.....	3-5
Figure 8.	Temporary Containment Device Placed Under a Hose Connection.	3-9
Figure 9.	Loading Docks with an Overhang to Prevent Material Contact with Stormwater.	3-11
Figure 10.	Structure Used To Cover Manufacturing Activities.	3-30
Figure 11.	Covered and Secured Storage Area for Bulk Solids.	3-33
Figure 12.	Covered Storage Area for Erodible Material (gravel).....	3-34
Figure 13.	Covered and Secured Storage Area for Containers.	3-39
Figure 14.	Containers Surrounded by a Berm in an Enclosed Area.	3-39

CHAPTER 1 – INTRODUCTION

1.1. What Is the Purpose of This Volume?

This volume is designed to help businesses, individuals, responsible parties, and public agencies in Seattle implement best management practices (BMPs) for source control to prevent pollutants from contaminating stormwater runoff and entering receiving waters, such as rivers, lakes, streams and Puget Sound. Polluted stormwater can pose risks to the health, safety, and welfare of humans and the environment. Source control is the practice of preventing pollution at its source.

This chapter provides a worksheet for use in determining which BMPs are required for specific activities, including activities planned for proposed development sites. As required by the Seattle Municipal Code (SMC), Chapters 22.800 through 22.808 (Stormwater Code), BMPs from this volume must be implemented to minimize contamination and discharge of stormwater from pollution generating activities.

[See-Refer to Appendix A](#) for definitions of technical terms used in this [volumemanual](#).

1.2. How Does this Volume Apply to Businesses and Properties?

Some BMPs are required for all real property in Seattle (refer to *Chapter 2*). The implementation of additional BMPs for specific pollution generating activities applies to all businesses and public agencies in Seattle except those that drain to the public combined sewer (refer to *Chapter 3*).

The BMPs in this volume have been integrated from many documents, programs and regulations, including the following:

- Federal Clean Water Act
- Federal Coastal Zone Management Act
- Phase I National Pollutant Discharge Elimination System (NPDES) Municipal Stormwater General Permit
- Washington State Department of Ecology (Ecology) Stormwater Management Manual for Western Washington (SWMMWW)
- Puget Sound Action Agenda
- The City's Stormwater Code (SMC, Chapters 22.800 through 22.808)

Owners, operators, and occupants of property, and anyone causing or contributing to a violation of the City Code are each considered a “responsible party” for purposes of a Code violation (SMC, [Section 22.801.190](#)).

If a commercial property is owned, leased, or rented to tenants, the owner is also responsible for any pollution from the property and can be held responsible for water quality problems caused by tenants. Make sure tenants are informed of their responsibilities.

1.3. Which Pollutants Are Targeted in This Volume?

The following provides descriptions of typical pollutants targeted by the source control BMPs outlined in this manual, including explanations of why the pollutants can be harmful and some of the common sources of these pollutants.

1.3.1. pH

The pH value of a substance is a measurement of its acidity or alkalinity. The pH of a body of water is vitally important because most aquatic life survives within a relatively narrow range of pH values (6.5 to 8.5). A pH that is lower than 6.5 can be too acidic to support aquatic life. A pH that is higher than 8.5 can be too alkaline to support aquatic life. Some sources that can contribute to a change in the pH of stormwater and receiving waters are:

- Cement in poured concrete
- Cement dust
- Materials used in paving and recycling operations
- Solutions used in metal plating operations
- Chemicals from printing and other industrial processes
- Common cleaners such as bleaches and deck cleaners
- Calcium chloride

1.3.2. Total Suspended Solids

Total suspended solids can include particles such as sand, silt, soil, iron precipitates, and biological solids, all of which can increase the turbidity in receiving waters (make the water cloudy) and can settle out in streams as sediment. This can destroy fish habitat and other aquatic life because excess sediment has the potential to smother aquatic organisms, including developing fish eggs, and also coat them with toxic substances such as petroleum and metals, which can adhere to the sediment in receiving waters.

1.3.3. Chemical and ~~Biological~~ Biochemical Oxygen Demanding Substances

Chemical wastes and degradable organic matter (such as landscaping waste and food waste) can drastically affect water quality if allowed to enter stormwater. As these substances are broken down by bacteria, the oxygen in the water is depleted. The resulting decrease in oxygen supply can stress or eventually kill fish and other aquatic species. Chemical oxygen demand (COD) and biological oxygen demand (BOD) are two parameters that indicate the amount of oxygen that is used up by various pollutants.

1.3.4. Metals

Metals are used in many products and include copper, lead, zinc and arsenic. Certain metals wear off vehicle brakes, tires, and galvanized surfaces, and are released from paint, scrap metal, and protective coatings used on buildings. Metals such as zinc can also be a component

in products such as moss killers. These metals can be carried by stormwater runoff into receiving waters where they have been linked to severe health and reproductive problems in fish and other aquatic animals.

1.3.5. Bacteria and Viruses

Bacteria and viruses from animal wastes, wildlife, illicit connections, and leaking sewer lines can contaminate receiving waters and result in the closure of swimming and shellfish areas. Concentrations of bacteria called fecal coliform, —enterococci in marine water, and *Escherichia coli* in fresh water—are typically used as indicators of pollution.

1.3.6. Nutrients

In the context of water quality, the nutrients of concern are primarily compounds that contain nitrogen and phosphorus. Excess nutrients allowed to enter receiving waters can lead to overgrowth of algae, depletion of oxygen in the water, and channel clogging due to the overgrowth of vegetation. The water can also become unattractive for recreational use and unsuitable for fish and wildlife. Sources of nutrients include fertilizers, leaking trash containers, leaking sewer lines, yard waste, and animal waste.

1.3.7. Toxic Organic Compounds

A number of organic compounds are toxic to the aquatic environment. Many pesticides, herbicides, rodenticides, and fungicides contain organic compounds that can be deadly to aquatic life. The same is true of organic compounds included in antifreeze, wood preservatives, cleansers, and a host of other more exotic organic compounds that result from industrial operations or past industrial practices (such as phthalates, polychlorinated biphenyls [PCBs], dioxins, and chlordane). These toxic organic compounds can remain in the sediment for a long time.

1.3.8. Other Chemicals and Substances

There are many other chemicals and substances that can cause problems if they are allowed to enter the aquatic environment. Even compounds classified as “biodegradable” or “environmentally friendly” can have devastating effects on aquatic life. Some of the most common chemicals and substances that pollute stormwater are oils, greases, soaps, and detergents.

1.3.9. Oils and Greases

Oil and grease can be generated from either petroleum-based or food-based sources. Oils and greases conveyed in stormwater can accumulate in receiving waters and contaminate soil. Petroleum-based oils and greases can be immediately toxic to fish and wildlife. Food-based oils and greases can coat insects and fish gills, leading to suffocation.

1.3.10. Soaps and Detergents

Vehicles and structures are commonly washed with soaps and other detergents mixed with water. If not managed properly, the resulting washwater can flow to an inlet/catch basin or

ditch, which discharges the polluted water directly to the nearest stream or lake, or to Puget Sound. Soaps and detergents, even the biodegradable ones, can have immediate and long-term effects on aquatic life. Sediment and oil released when vehicles and structures are washed with soaps and detergents can also collect in the washwater, causing further harm to fish and other aquatic wildlife. Soaps used on roofs to treat moss can also result in soaps being discharged via roof drains to receiving waters.

The term “biodegradable” on a product label does not mean that the product is safe or environmentally friendly. The product may degrade faster than alternative products but can still be harmful to the environment.

1.4. What Are BMPs?

BMPs for managing stormwater are divided into two broad categories: source control BMPs and treatment BMPs.

1.4.1. Source Control BMPs

Source control BMPs prevent contaminants from entering stormwater runoff by controlling them at their source. Source control can include operational changes (such as sweeping or process changes) or structural changes (such as extending a roof or installing a treatment facility).

Source control requirements are based on the following goals:

1. Prevent stormwater pollution by eliminating pathways that may introduce pollutants into stormwater.
2. Protect soil, groundwater, and receiving waters by capturing acute releases, such as spills, to reduce chronic contamination of the environment.
3. Segregate stormwater and wastewater flows.
4. Direct wastewater discharges and areas with the potential for wastewater discharge (such as vehicle washing facilities) to the sanitary or combined sewer system.
5. Provide an approved method of containment and discharge for areas that have the potential for spills, and are not expected to regularly receive stormwater flow or require water use (such as covered fuel islands or covered containment areas).
6. Create a combination of structural controls and operational procedures to ensure sustainability of the BMPs.

1.4.2. Treatment BMPs

This volume also identifies specific treatment BMPs that apply to particular pollutant sources such as fueling stations, railroad yards, and the outdoor storage and transfer of materials, byproducts, or finished products. Examples of treatment BMPs are oil/water separators, wet vaults, and biofilters. After identifying the required treatment BMPs, refer to *Volume 3 – Project Stormwater Control* for additional information about treatment BMPs.

1.5. Already Implementing Best Management Practices?

Property owners and operators may already be implementing BMPs in accordance with other federal, state, or local requirements (e.g., businesses that have a National Pollutant Discharge Elimination System [NPDES] permit from Ecology). In some cases, the City's requirements may be in addition to, or more stringent than other applicable requirements. Anyone with questions about how to meet all of the source control requirements for stormwater should contact the City of Seattle Stormwater Source Control Unit via the Water Quality Hotline at (206) 684-7587. City inspectors will work with responsible parties to determine the applicable BMPs.

If it is determined that the BMPs being implemented are not effectively addressing the discharge of contaminants, additional BMPs may be required, including treatment and structural BMPs.

Entities that conduct specific industrial activities are required to obtain an Industrial NPDES Permit for their stormwater discharges. For more information about whether an entity needs an NPDES permit, refer to Ecology's website (<https://ecology.wa.gov/Water-Shorelines/Water-quality/Runoff-pollution/Stormwater>www.ecy.wa.gov/programs/wq/stormwater/index.html) or call Ecology at (360) 407-6000.

1.6. Getting Started

To understand the source control requirements addressed by this volume, the first step is to determine if the property discharges to the combined sewer, drainage system, or receiving water. If the answer is not clear, call the Water Quality Hotline at (206) 684-7587 Option 3 and request assistance.

All real property in Seattle must implement ~~the citywide~~ [BMPs 1 through BMP 8 for all real property](#) outlined in [Section 2.1](#) ~~Chapter 2~~. [BMP 9 through BMP 16 also apply to all real property but are related to specific activities that may occur at a property.](#)

In addition, businesses and public agencies, except those that discharge only to the public combined sewer, must implement the additional BMPs pertinent to site-specific activities outlined in *Chapter 3*.

The worksheet provided below (Table 1) is designed to help identify the appropriate BMPs required. The worksheet contains BMPs organized by the different activities that businesses and public agencies perform. If the listed activity is performed indoors and all discharges (e.g., process water, washwater, lubricants, solvents, fugitive dust, granular material, and blowdown waste) are controlled such that there is no exposure of stormwater to pollutants, then additional BMPs do not have to be implemented for that activity.

1. Complete all sections of the worksheet, checking the appropriate boxes for all activities that occur at the work place.
2. If any of the activities were checked as being performed outdoors (or inside in areas that might spill or flow outside), additional BMPs are required for that activity. Refer

to the subsection of this volume identified in the first column of the worksheet for a description of the required BMPs.

Questions can be answered by leaving a message on the [SPU Water Quality Hotline](tel:2066847587) at (206) 684-7587 or contacting the SPU Green Business Program at (206) 343-8505 or on the [City's website at: \(www.seattle.gov/util/ForBusinesses/GreenYourBusiness/index.htm\)](http://www.seattle.gov/util/ForBusinesses/GreenYourBusiness/index.htm).

Table 1. Worksheet for Identifying Applicable BMPs.

Section Reference	BMP Number and Name	
<u>SECTION 2.1 – REQUIRED CITYWIDE BEST MANAGEMENT PRACTICES FOR ALL REAL PROPERTY</u>		
2.1.1	BMP 1: Eliminate Illicit Connections <u>and Illicit Discharges</u>	
2.1.2	BMP 2: Perform Routine Maintenance	
2.1.3	BMP 3: Dispose of Fluids and Wastes Properly	
2.1.4	BMP 4: Proper Storage of Solid Wastes	
2.1.5	BMP 5: Spill Prevention and Cleanup	
2.1.6	BMP 6: Provide Oversight and Training for Staff	
2.1.7	BMP 7: <u>Site-Property</u> Maintenance	
<u>2.1.8</u>	<u>BMP 8: Rooftop Dog Runs</u>	
Section Reference	BMP Number and Name	Is Activity Conducted on the Site?
<u>BUSINESS AND PUBLIC ENTITY BEST MANAGEMENT PRACTICES FOR SPECIFIC ACTIVITIES^a</u>		
<u>2.2.1</u>	BMP 9: Fueling at Dedicated Stations <ul style="list-style-type: none"> • <u>Applies to gas stations, pumps at fleet vehicle yards or shops, and other privately owned pumps, including construction sites</u> 	
<u>2.2.2</u>	BMP 10: Mobile Fueling of Vehicles and Heavy Equipment <ul style="list-style-type: none"> • <u>Applies to fleet fueling, wet fueling, and wet hosing</u> 	
<u>2.2.3</u>	BMP 11: In-Water and Over-Water Fueling	
<u>2.2.4</u>	BMP 12: Maintenance and Repair of Vehicles and Equipment <ul style="list-style-type: none"> • <u>Applies to vehicle maintenance operations and activities where fluids from vehicles and equipment are removed and replaced at permanent or temporary sites</u> 	
<u>2.2.5</u>	BMP 13: Concrete and Asphalt Mixing and Production <ul style="list-style-type: none"> • <u>Applies to the mixing of raw materials on the site to produce concrete or asphalt or the making of concrete or asphalt products</u> 	
<u>2.2.6</u>	BMP 14: Concrete Pouring, Concrete/Asphalt Cutting, and Asphalt Application <ul style="list-style-type: none"> • <u>Applies to construction sites, driveway, and parking lot resurfacing, and cutting</u> 	
<u>2.2.7</u>	BMP 15: Recycling, Wrecking Yard, and Scrap Yard Operations <ul style="list-style-type: none"> • <u>Applies to scrapped equipment, vehicles, construction materials, and assorted recyclables</u> 	
<u>2.2.8</u>	BMP 16: Storage of Liquids in Aboveground Tanks <ul style="list-style-type: none"> • <u>Applies to all liquids in aboveground tanks</u> 	
<p>^a <u>BMP 9 through BMP 16 apply to All Real Property, but are related to specific activities that may occur at a businesses or be performed by public agencies.</u></p> <p>Does site drain only to the public combined sewer?</p> <ul style="list-style-type: none"> • If yes, only <i>Chapter 2</i> BMPs are required. • If no, fill out the remainder of the worksheet to determine applicable BMPs for site activities per SMC₁ <u>Section 22.803.040.</u> <p>If unsure where the site discharges to, call the Water Quality Hotline at (206) 684-7587 for assistance.</p>		

Table 1 (continued). Worksheet for Identifying Applicable BMPs.

Section Reference	BMP Number and Name	Is Activity Conducted in an Area That Could Impact the Drainage System or Receiving Waters?
SECTION 3.1 – CLEANING OR WASHING		
3.1.1	BMP 178 : Cleaning or Washing <ul style="list-style-type: none"> ● Applies to all outdoor washing activities, including the following: ● Cleaning or washing of tools, engines, manufacturing equipment, vents, filters, pots and pans, grills, and floor mats ● Fleet vehicle yards, car dealerships, car washes, and maintenance facilities ● Mobile washing, including carpet cleaning, pressure washing, truck washing, etc. 	
SECTION 3.2 – TRANSFER OF LIQUID OR SOLID MATERIALS		
3.2.1	BMP 189 : Loading and Unloading of Liquid or Solid Material <ul style="list-style-type: none"> ● Applies to loading and unloading of liquid or solid materials 	
3.2.2	BMP 10: Fueling at Dedicated Stations <ul style="list-style-type: none"> ● Applies to gas stations, pumps at fleet vehicle yards or shops, and other privately owned pumps, including construction sites 	
3.2.3	BMP 11: Maintenance and Repair of Vehicles and Equipment <ul style="list-style-type: none"> ● Applies to vehicle maintenance operations and activities where fluids from vehicles and equipment are removed and replaced at permanent or temporary sites 	
3.2.4	BMP 12: Mobile Fueling of Vehicles and Heavy Equipment <ul style="list-style-type: none"> ● Applies to fleet fueling, wet fueling, and wet hosing 	
SECTION 3.3 – PRODUCTION AND APPLICATION ACTIVITIES		
3.3.1	BMP 13: Concrete and Asphalt Mixing and Production <ul style="list-style-type: none"> ● Applies to mixing of raw materials on the site to produce concrete or asphalt or making concrete or asphalt products 	
3.3.2	BMP 14: Concrete Pouring, Concrete/Asphalt Cutting, and Asphalt Application <ul style="list-style-type: none"> ● Applies to construction sites, driveway and parking lot resurfacing, and cutting 	
3.3.13.3.3	BMP 1945 : Manufacturing and Post-processing of Metal Products <ul style="list-style-type: none"> ● Applies to machining, grinding, soldering, cutting, welding, quenching, rinsing, etc. 	
3.3.23.3.4	BMP 2046 : Processing and Storage of Treated Wood <ul style="list-style-type: none"> ● Applies to chemical preservative treatment of wood, as well as outdoor storage 	
3.3.33.3.5	BMP 2147 : Commercial Composting <ul style="list-style-type: none"> ● Applies to commercial composting facilities that operate outside without cover 	

Table 1 (continued). Worksheet for Identifying Applicable BMPs.

Section Reference	BMP Number and Name	Is Activity Conducted in an Area That Could Impact the Drainage System or Receiving Waters?
3.3.43.3.6	BMP 2248 : Landscaping and Vegetation Management <ul style="list-style-type: none"> Applies to grading, storage of landscape materials, soil transfer, vegetation removal, pesticide and fertilizer applications, and watering 	
3.3.53.3.7	BMP 2349 : Painting, Finishing, and Coating Activities <ul style="list-style-type: none"> Applies to surface preparation and the application of paints, finishes, and/or coatings 	
3.3.63.3.8	BMP 2420 : Commercial Printing Operations <ul style="list-style-type: none"> Applies to materials used in the printing process 	
3.3.73.3.9	BMP 2524 : Manufacturing Activities <ul style="list-style-type: none"> Applies to manufacturing activities in outdoor areas 	
SECTION 3.4 – STORAGE AND STOCKPILING ACTIVITIES		
3.4.1	BMP 2622 : Storage or Transfer of Leachable or Erodible Materials <ul style="list-style-type: none"> Includes sand, topsoil, lumber, and other products 	
3.4.2	BMP 2723 : Temporary Storage or Processing of Fruits, Vegetables, or Grains <ul style="list-style-type: none"> Applies to storage of fruits, vegetables, or grains; and processing activities at: wineries; breweries; fresh and frozen juice makers; and other food and beverage processing operations 	
3.4.3	BMP 24: Recycling, Wrecking Yard, and Scrap Yard Operations <ul style="list-style-type: none"> Applies to scrapped equipment, vehicles, construction materials, and assorted recyclables 	
SECTION 3.4 (continued) – STORAGE AND STOCKPILING ACTIVITIES		
3.4.33.4.4	BMP 2825 : Portable Container Storage <ul style="list-style-type: none"> Applies to containers used for temporary and permanent storage 	
3.4.5	BMP 26: Storage of Liquids in Aboveground Tanks <ul style="list-style-type: none"> Applies to all liquids in aboveground tanks 	
3.4.6	BMP 27: Lot Maintenance and Storage <ul style="list-style-type: none"> Applies to public and commercial parking areas Applies to storage of automobile parts, vehicles, or equipment 	
SECTION 3.5 – DUST, SOIL EROSION, AND SEDIMENT CONTROL		
3.5.1	BMP 2928 : Dust Control in Disturbed Land Areas and on Unpaved Roadways and Parking Lots <ul style="list-style-type: none"> Applies to dust control measures in disturbed land areas or on unpaved roadways and parking lots 	
3.5.2	BMP 3029 : Dust Control at Manufacturing Sites <ul style="list-style-type: none"> Applies to grain dust, sawdust, coal, gravel, crushed rock, cement, boiler fly ash, and other airborne polluting materials 	

Table 1 (continued). Worksheet for Identifying Applicable BMPs.

Section Reference	BMP Number and Name	Is Activity Conducted in an Area That Could Impact the Drainage System or Receiving Waters?
3.5.3	BMP 3130 : Soil Erosion and Sediment Control at Industrial Sites <ul style="list-style-type: none"> Applies to industrial activities that take place on soil 	
SECTION 3.6 – OTHER ACTIVITIES		
3.6.1	BMP 3234 : Commercial Animal Care and Handling <ul style="list-style-type: none"> Applies to operations at kennels, fenced pens, veterinary clinics, and businesses and public agencies that board animals 	
3.6.2 and Ecology Pub. 04-10-034	BMP 3332 : Log Sorting and Handling <ul style="list-style-type: none"> Applies to log yards 	
3.6.3	BMP 3433 : Boat Building, Mooring, Maintenance, and Repair <ul style="list-style-type: none"> Applies to all types of maintenance, repair, and building operations at shipyards, ports, and marinas 	
3.6.4	BMP 3534 : Cleaning and Maintenance of Pools, Spas, Hot Tubs, and Fountains <ul style="list-style-type: none"> Applies to cleaning and maintenance of pools, spas, hot tubs, and fountains, including all commercial pool cleaners 	
3.6.5	BMP 3635 : Deicing and Anti-icing Operations for Airports and Streets <ul style="list-style-type: none"> Applies to highways, aircraft, runways and taxiways, and streets 	
SECTION 3.6 (continued) – OTHER ACTIVITIES		
3.6.6	BMP 3736 : Maintenance and Management of Roof and Building Drains at Manufacturing and Commercial Buildings <ul style="list-style-type: none"> Applies to maintenance and management of roofs and sides of manufacturing and commercial buildings 	
3.6.7	BMP 3837 : Maintenance and Operation of Railroad Yards <ul style="list-style-type: none"> Applies to cleaning, maintenance, and repair of equipment and engines; fueling; waste disposal; and all other yard maintenance activities 	
3.6.8	BMP 3938 : Maintenance of Public and Private Utility Corridors and Facilities <ul style="list-style-type: none"> Applies to maintenance activities related to public and private utilities, including pipelines, pump stations, rights-of-way, and transmission corridors 	
3.6.9	BMP 4039 : Maintenance of Roadside Ditches <ul style="list-style-type: none"> Applies to activities related to the maintenance of roadside ditches 	
3.6.10	BMP 41: Potable Water Line Flushing, Water Tank Maintenance, and Hydrant Testing	
3.6.11	BMP 42: Urban Streets	
3.6.12	BMP 43: Nurseries and Greenhouses	

Table 1 (continued). Worksheet for Identifying Applicable BMPs.

Section Reference	BMP Number and Name	Is Activity Conducted in an Area That Could Impact the Drainage System or Receiving Waters?
3.6.13	BMP 44: Color Events	
3.6.14	BMP 45: Pet Waste	
3.6.15	BMP 46: Labeling Storm Drain Inlets on Your Property	
3.6.16	BMP 47: Well, Utility, Directional, and Geotechnical Drilling	
3.6.17	BMP 48: Goose Waste	
3.6.18	BMP 49: Pesticides and an Integrated Pest Management Program	
3.6.19	BMP 50: Storage of Dry Pesticides and Fertilizers	
3.6.20	BMP 51: Irrigation	
3.6.21	BMP 52: Dock Washing	
3.6.22	BMP 53: Roof Vents	
3.6.23	BMP 54: Streets and Highways	
3.6.24	BMP 55: Fertilizer Application	

Notes:

^a—If this activity could impact stormwater or receiving waters, refer to the corresponding section of this volume (identified in the first column) for BMP descriptions.

CHAPTER 2 – ~~CITYWIDE~~ BEST MANAGEMENT PRACTICES FOR ALL REAL PROPERTY

2.1. Required ~~Citywide~~ Best Management Practices

All real property must implement and maintain the following source control [best management practices](#) (BMPs) to prevent or minimize pollutants from leaving a site or property ([Seattle Municipal Code \[SMC\]](#), Section 22.803.030):-

- [BMP 1: Eliminate Illicit Connections and Illicit Discharges](#)
- [BMP 2: Perform Routine Maintenance](#)
- [BMP 3: Dispose of Fluids and Wastes Properly](#)
- [BMP 4: Proper Storage of Solid Wastes](#)
- [BMP 5: Spill Prevention and Cleanup](#)
- [BMP 6: Provide Oversight and Training for Staff](#)
- [BMP 7: Property Maintenance](#)
- [BMP 8: Rooftop Dog Runs](#)

~~Owners, operators, and occupants of property, and anyone causing or contributing to a violation of the Stormwater Code (Code) are each considered a “responsible party” relative to a Code violation (SMC, Section 22.801.190).~~

Stormwater Code Language	References
SMC, Section 22.803.030 – <i>For all discharges, responsible parties shall implement and maintain source controls to prevent or minimize pollutants from leaving a site or property.</i>	<ul style="list-style-type: none"> ● None provided
SMC, Section 22.801.090 – “Responsible party” means all of the following persons: 1. Owners, operators, and occupants of property; and 2. Any person causing or contributing to a violation of the provisions of this subtitle.	<ul style="list-style-type: none"> ● None provided

2.1.1. [BMP 1: Eliminate Illicit Connections and Illicit Discharges](#)

Illicit connections [and discharges](#) include sanitary or process wastewater connections [and unpermitted discharges of pollutants](#) that are improperly discharging to a drainage system or receiving water. These improper connections [and discharges](#) allow a variety of pollutants to flow directly to receiving waters instead of the sanitary sewer or septic system. Frequently, such connections [and discharges](#) are not intentional, but can be very harmful to the environment and must be eliminated. Refer to *Volume 1, Section 3.11* for the minimum requirements to comply with the Seattle Side Sewer Code (SMC, Chapter 21.16).

Required elements of this BMP include:

- For all real properties, responsible parties must examine their plumbing systems to identify any potential illicit connections. A good place to start is with an examination of the site plans. Remodeling and tenant improvement projects are particularly susceptible to inadvertent illicit connections. If an illicit connection is suspected, [perform a trace the source using](#) closed-circuit television inspection (CCTV) ~~or~~ dye test with a nontoxic dye, [smoke testing, flow test, or visual reconnaissance](#). These tests are typically best performed by qualified personnel such as a plumbing contractor. Notify [the Washington State Department of Ecology \(Ecology\)](#)'s Northwest Regional Office at (425) 649-7000 and [Seattle Public Utilities \(SPU\)](#) at (206) 386-1800 prior to performing a dye test that may result in a discharge to a receiving water.
- If illicit connections are found, permanently plug or disconnect the connections.
- Obtain all necessary permits for altering or repairing side sewers and plumbing fixtures. Restrictions on certain types of discharges, particularly industrial process waters, may require pretreatment of discharges before they enter the sanitary sewer. It is the responsibility of the property owner or business operator to obtain the necessary permits and to replace the connection.
- The Stormwater Code allows the Director to require that a responsible party provide or create site drainage and sewer system maps with verified discharge points to aid in identifying illicit connections and/or to verify that illicit connections are eliminated.
- [Eliminate illicit discharges to drainage systems and receiving waters.](#)

2.1.2. *BMP 2: Perform Routine Maintenance*

Sediment and pollutants can accumulate over time in various components of drainage collection, conveyance, and treatment systems, such as catch basins, ditches, storm drains, and oil/water separators. When a storm event occurs, the excessive sediment and pollutants can become mobilized and carried into receiving waters, [the public drainage system, or a public combined sewer](#). Performing routine maintenance is required and helps prevent sediment and pollutants from discharging downstream.

Required elements of this BMP include:

- Inspect all conveyance, detention and treatment systems at least annually and clean or repair structures whenever the condition thresholds described in *Appendix G* are triggered. Systems in industrial areas or areas that receive excessive sediment, foliage or debris may require more frequent inspection and maintenance. If leaves or woody debris accumulate on catch basins and inlets, clean as needed to prevent flooding.
- Clean catch basins when they are greater than 60 percent full of sediment, within 6 inches of the bottom of the lowest pipe, or there are obvious signs of pollution visible. At 60 percent capacity, there is not enough settling space to remove sediment from stormwater and they cease to function as designed.
- All catch basins are required to have outlet traps (downturned elbow) ~~similar to City of Seattle Standard Plan No. 267~~. Outlet traps help to keep oil and other floatables from discharging to the public drainage system, [public combined sewer](#), or receiving waters. Replace or repair outlet traps when missing or damaged. When catch basins lack sufficient depth or room to install an outlet trap, evaluate the drainage system to determine if there is an appropriate downstream location and install an outlet trap at that location.
- Properly dispose of all solids, polluted material, and stagnant water collected through system cleaning. ~~Do not decant water back to the system. Do not decant untreated, treated, or filtered water back into drainage system~~. Do not jet material downstream into the system. In all systems, known or suspected contaminated material may need to be tested for additional disposal requirements.

Consider posting “Dump No Waste” or other warning signs adjacent to inlets/catch basins where possible.

Several contractors offer cleaning services for drainage systems. A list of contractors can be found on the SPU website, online, or in the Yellow Pages under entries such as “Sewer Contractors.”

2.1.3. *BMP 3: Dispose of Fluids and Wastes Properly*

For all real properties, responsible parties must properly dispose of solid and liquid wastes and contaminated stormwater and ~~sediment~~street waste solids. There are generally ~~four~~five options for disposal, depending on the type of waste:

1. Recycling facilities
- ~~1-2.~~ Permitted centralized waste treatment facilities
- ~~2-3.~~ Municipal solid waste disposal facilities
- ~~3-4.~~ Hazardous waste treatment, storage, and disposal facilities
- ~~4-5.~~ Sanitary sewer or combined sewer

Some liquid wastes and contaminated stormwater (depending on the pollutants and associated concentrations) may be discharged to the sanitary sewer system, but are subject to approval by the City and King County. Restrictions on certain types of discharges may require pretreatment of discharges before they enter the sanitary sewer.

If wastes cannot be legally discharged to a sanitary sewer, one of the other three disposal options must be used. Sumps or holding tanks may be useful for storing liquid wastes temporarily. The contents must be disposed of properly.

Contaminated ~~sediment~~street waste solids ~~must~~must be handled by following either the guidance in Management of Street Waste Solids and Liquids in Appendix IV-B of the Stormwater Management Manual for Western Washington (SWMMWW) (Ecology 2019) or the Dangerous Waste Regulations (Washington Administrative Code [WAC], Chapter 173-303), if applicable. ~~If testing determines materials are not dangerous waste but contaminants are present, consult with Public Health—Seattle & King County for disposal options.~~

For assistance with finding recycling facilities, refer to the King County Green Tools web page (<https://kingcounty.gov/depts/dnrp/solid-waste/programs/green-building.aspx>).

For assistance in determining where to take motor oil, pesticides, smoke alarms, fluorescent bulbs, and other hazardous materials, refer to the Local Hazardous Waste Management Program website (www.hazwastehelp.com).

Required elements of this BMP include:

- Dispose of wastes in accordance with applicable solid waste, dangerous waste, industrial waste, and other regulations.

2.1.4. *BMP 4: Proper Storage of Solid Wastes*

This BMP applies to properties that store solid wastes, including garbage, recyclables, compostable materials, and cooking grease containers outdoors. If improperly stored, these wastes can contribute a variety of pollutants to stormwater.

Required elements of this BMP include:

- Store all solid wastes in suitable containers (Figure 1). Check storage containers [and trash compactors](#) for damage and replace them if they are leaking, corroded, or otherwise deteriorating.



Figure 1. Covered Outdoor Storage of Solid Wastes.

- Ensure that storage containers have leak-proof lids or are covered by some other means, and that lids are closed at all times.
- Sweep the waste storage area or clean frequently to collect all loose solids for proper disposal in a storage container. ~~When washing the area, contain and properly dispose of washwater.~~
- ~~Connect trash compactors equipped with a drain hose to the sanitary sewer. Drain dumpsters, dumpster pads, and trash compactors to the sanitary sewer.~~
- ~~Connect areas containing dumpsters and trash compactors to the sanitary sewer, unless equipped with a drain hose.~~
- ~~Contain and properly dispose of washwater pursuant to BMP 17 (Cleaning or Washing) when washing dumpsters and used cooking oil containers.~~

- Clean up leaks and spills as they occur. Keep the area around ~~used cooking oil~~grease storage containers clean and free of ~~spilled grease, oils, food waste, and~~ debris.
- Storage Container Requirements for Used Cooking Oil:
 - Store used cooking oil containers indoors or on private property. When authorized by the Seattle Department of Transportation (SDOT) and SPU Solid Waste, containers can be stored in the right-of-way.
 - Owners of used cooking oil containers must implement the following:
 - Label each used cooking oil container with the following:
 - The name and phone number of container owner
 - Contains used cooking oil
 - Report spills by calling SPU at (206) 386-1800
 - Record all authorized users specific to each container.
 - Place and maintain lids on used cooking oil storage containers to prevent rainwater intrusion.
 - Do not fill storage containers beyond ~~allow accumulated waste to exceed 90 percent of their capacity of the storage container.~~ If this occurs accumulated used cooking oil exceeds 90 percent of the capacity of the storage container, obtain and use another suitable storage container. ~~Do not overfill containers.~~
 - Ensure that screens are kept clean and clear of debris.
 - Used cooking oil containers must be located to prevent tipping, spillage, vandalism, and vehicle impact. Spills resulting from damage, tipping, vandalism, and leaks are the responsibility of the owner of the container. Recommended approaches include:
 - Store used cooking oil in containers inherently resistant to tipping. Barrels are not tip resistant.
 - Locate used cooking oil containers on a level surface or secure them to prevent tipping.
 - Store used cooking oil in containers with a tight-fitting leak-resistant lid.
 - Store used cooking oil containers within a building or in a locked and secure area to prevent unauthorized use or vandalism.
 - Protect used cooking oil containers from vehicle impact by fenced enclosures, bollards, or other physical barriers.
 - Do not attempt to transfer used cooking oil from the kitchen to the used cooking oil container using overfilled small containers.
- For containers stored in the right-of-way, label with owner information and contents

2.1.5. BMP 5: Spill Prevention and Cleanup

Leaks and spills can damage public infrastructure, interfere with sewage treatment and cause a threat to human health or the environment. Spills are often preventable if appropriate chemical and waste handling techniques are practiced effectively and the spill response plan is immediately implemented. Additional spill control requirements may be required based on the specific activity occurring on site.

A spill can be a one-time event, a continuous leak, or frequent small spills. All types must be addressed. [Spills resulting from vandalism or inadequate waste management are the responsibility of the waste owner.](#)

Businesses and real properties that load, unload, store, and manage liquids or other erodible materials must implement this BMP.

2.1.5.1. Spill Prevention

Implement the following practices and provide spill cleanup kits (*Section 2.1.5.3*) at activity locations where spills may occur:

- Clearly [mark or](#) label all containers that contain potential pollutants.
- Store and transport liquid materials in appropriate containers with tight-fitting lids.
- Place drip pans underneath all containers, fittings, valves, and where materials are likely to spill or leak. [Check drip pans periodically to prevent overflow during rain events.](#)
- Use tarpaulins, ground cloths, or drip pans in areas where materials are mixed, carried, and applied to capture any spilled materials.
- Train employees on the safe techniques for handling materials used on the site and to check for leaks and spills.

2.1.5.2. Spill Plan

- Develop and implement a spill plan and update it annually or whenever there is a change in activities or staff responsible for spill cleanup. Post a written summary of the plan at areas with a high potential for spills, such as loading docks, product storage areas, waste storage areas, and near a phone (Figure 2). The spill plan may need to be posted at multiple locations. Describe the facility, including the owner's name, address, and telephone number; the nature of the facility activity; and the general types of chemicals used at the facility.
- Designate spill response employees to be on the site during business activities. Provide a current list of the names, and telephone numbers (office and home) of designated spill response employee(s) who are responsible for implementing the spill plan.
- Provide a site plan showing the locations of storage areas for chemicals, inlets/catch basins, spill kits and other relevant infrastructure or materials information.
- Describe the emergency cleanup and disposal procedures. Note the location of the spill kit in the spill plan.
- List the names and telephone numbers of public agencies to contact in the event of a spill. Refer to *Section 2.1.5.4* for more information.



Figure 2. Waste Storage Area with Spill Kit and Posted Spill Plan.

2.1.5.3. *Spill Cleanup Kit*

Store spill cleanup kits near areas with a high potential for spills so that they are easily accessible in the event of a spill. The contents of the spill kit must be appropriate to the types and quantities of materials stored or otherwise used at the facility, and refilled when the materials are used. A spill kit may include the following items:

- Absorbent pads
- Sorbent booms or socks
- Absorbent granular material (such as kitty litter)
- Protective clothing (such as latex gloves and safety goggles)
- Thick plastic garbage bags
- Drain cover

2.1.5.4. *Spill Cleanup and Proper Disposal of Material*

In the event of a spill, implement the following procedures:

- Implement the spill plan immediately.
- Contact the designated spill response employee(s).
- Block off and seal nearby inlets/catch basins to prevent materials from entering the drainage system or combined sewer.
- ~~Use an appropriate material to clean up spills. Do not use emulsifiers or dispersants such as liquid detergents or degreasers.~~
- At the earliest possible time, but in any case within 24 hours, report all spills, discharges, or releases that have impacted or could impact a drainage system, a combined sewer, a sanitary sewer, or a receiving water to the SPU Operations Response Center at (206) 386-1800. This reporting requirement is in addition to, and not instead of, any other reporting requirements under federal, state, or local laws. Other agencies may include Seattle Fire Department (206) 386-1400, Department of Ecology (425) 649-7000 and the National Response Center (800) 424-8802. Spill reporting should take priority over the collection of supporting information. In case of emergency, dial 911.
- Use an appropriate material to clean up spills. Do not use emulsifiers or dispersants such as liquid detergents or degreasers unless they are cleaned up afterwards.
- ~~Do not wash absorbent material into interior floor drains or inlets/catch basins. Do not wash absorbent materials into interior floor drains or inlets/catch basins. Pick up all absorbent materials for proper disposal after application. Spill cleanup is incomplete until all absorbent materials have been recovered.~~
- Dispose of used spill control materials in accordance with the Seattle Solid Waste Collection Code (SMC, Chapter 21.36), Dangerous Waste Regulations (WAC, Chapter 173-303), and applicable laws.

The SPU Green Business Program is a free conservation program funded by SPU. The program offers free technical assistance, free spill kits, and assistance in developing a spill plan. They can be reached by calling (206) 343-8505 or on the [City's website at: \(www.seattle.gov/util/ForBusinesses/GreenYourBusiness\)](http://www.seattle.gov/util/ForBusinesses/GreenYourBusiness).

2.1.6. BMP 6: Provide Oversight and Training for Staff

The key to sustaining BMPs is to ensure that staff are properly trained in their purpose and maintenance requirements. Assign source control maintenance as a job responsibility for staff.

For all businesses and public entities, required elements of this BMP include:

- Train all team members annually in the operation, maintenance, and inspection of BMPs. Keep training records on file.
- Train all team members annually in spill cleanup.
- Assign an employee to oversee implementation and management of stormwater source control ~~BMPs~~best management practices.

The SPU Green Business Program is a free conservation program funded by SPU. The program offers free technical assistance and can assist with employee training. They can be reached by calling (206) 343-8505 or on the City's website at: (www.seattle.gov/util/ForBusinesses/GreenYourBusiness).

2.1.7. *BMP 7: Site-Property Maintenance*

Good site-property maintenance reduces the potential for stormwater to come into contact with pollutants and can reduce maintenance intervals for the drainage system and combined sewer.

Public and commercial parking lots such as those for retail stores, fleet vehicles (including rent-a-car lots and car dealerships), and equipment sale and rental businesses; equipment storage yards; parking lot driveways; and restaurant drive-throughs can be sources of toxic hydrocarbons and other organic compounds, including oils and greases, metals, and suspended solids. Even sidewalks may need occasional cleaning and could generate pollutants.

For all businesses and public entities, required elements of this BMP include:

- ~~Where feasible, l~~ocate pollution generating activities away from stormwater pathways, such as inlets/catch basins, conveyance pipes, and ditches.
- Sweep or vacuum paved areas used for loading and unloading of materials, outdoor production and manufacturing, driveways, parking lots, sidewalks, and storage areas as needed to prevent pollutant transport off site or to the drainage system. Mechanical or hand sweeping may be necessary for areas that a vacuum sweeper cannot reach.
- Do not hose down or otherwise transport pollutants from any area to the ground, drainage system, combined sewer, or receiving water except where permissible pursuant to SMC, Section 22.802.030.
- Discharges of street and sidewalk washwater may be permitted when surfaces are swept prior to washing, detergents are not used, and water use is minimized.
- Promptly contain and clean up solid and liquid leaks and spills (refer to BMP 5 for specific information on spill prevention and cleanup).
- Inspect areas used for loading and unloading, material/waste storage, and vehicle parking as needed to prevent pollutant transport off site or to the drainage system.
- ~~Do not hose down or otherwise transport pollutants from any area to the ground, drainage system, combined sewer, or receiving water.~~Place drip pans, absorbent pads, or other containment vessels below leaking vehicles (including inoperable vehicles and equipment) in a manner that catches leaks or spills. Drip pans or other containment measures must be managed to prevent overflowing and the contents disposed of properly. Absorbent pads must be weighted down so they do not blow away and must be inspected and changed out and disposed of properly before becoming fully saturated.
- For properties other than those that drain only to the combined sewer, an oil removal system such as an American Petroleum Institute (API) oil/water separator, coalescing plate oil/water separator, catch basin filter sock, or equivalent BMP that is approved by SPU is required for parking lots that meet the threshold for vehicle traffic intensity of a “high-use site.” Refer to SMC, Section 22.801.090 for the definition of “high-use site.”

2.1.8. BMP 8: Rooftop Dog Runs

Rooftop dog runs are sometimes provided as an amenity at large residential and commercial properties. Dog runs are typically constructed with artificial turf and other dog-friendly amenities that can accumulate pet waste. They often have automatic sprinklers to wash down the area.

Pet waste that washes into lakes, streams, or Puget Sound begins to decay, depleting oxygen and releasing ammonia. Low oxygen concentrations and ammonia combined with warm water can kill fish. Pet waste also contains nutrients that encourage the growth of weeds and algae and contribute to low oxygen concentrations and high pH in waters we use for swimming, boating, and fishing. Most importantly, pet waste can carry viruses and bacteria that could cause disease and lead to beach closures or bans on shellfish harvesting.

The following required elements of this BMP apply to all dog runs located on rooftops or above-grade plazas:

- Prevent stormwater discharge from the dog run from flowing directly or indirectly to a public drainage system, private drainage system, drainage control facility, or receiving water body.
- Drainage from dog runs, including overflow drainage, must be plumbed to the building sanitary sewer.
- No more than 200 square feet of uncovered dog run area may discharge to the sanitary sewer. This is to prevent excess stormwater from entering the public sanitary sewer system. The portion of a dog run area that is greater than 200 square feet must be covered. The cover must be a roof or canopy that prevents stormwater from coming in contact with the dog run area and directs uncontaminated stormwater runoff to the building drainage system per the requirements of the Seattle Plumbing Code.
- In combined sewer areas, dog runs greater than 200 square feet do not require a cover, but all drainage from the dog run area must be directed to the building sanitary sewer system. This contaminated stormwater runoff must not be connected to a combined side sewer until downstream of the entire building drainage system, including all drainage collection and control facilities such as detention vaults. (Note: If the dog run is part of a construction project that requires flow control (refer to Volume 1), the uncovered dog run area must be modeled as an uncontrolled bypass area that connects to the point of compliance and the flow control BMPs must be oversized to account for this bypass area.)

2.2. Required Best Management Practices for Specific Activities

For business and public entities with specific pollution-generating activities, the following BMPs must be implemented to prevent or minimize pollutants from leaving a site or property:

- [BMP 9: Fueling at Dedicated Stations](#)
- [BMP 10: Mobile Fueling of Vehicles and Heavy Equipment](#)
- [BMP 11: In-Water and Over-Water Fueling](#)
- [BMP 12: Maintenance and Repair of Vehicles and Equipment](#)
- [BMP 13: Concrete and Asphalt Mixing and Production](#)
- [BMP 14: Concrete Pouring, Concrete/Asphalt Cutting, and Asphalt Application](#)
- [BMP 15: Recycling, Wrecking Yard, and Scrap Yard Operations](#)
- [BMP 16: Storage of Liquids in Aboveground Tanks](#)

<u>Stormwater Code Language</u>	<u>References</u>
<p><i>SMC, Section 22.803.040 – For all discharges, source controls shall be implemented, to extent allowed by law, by businesses and public entities for the following specific pollution-generating activities as specified in the joint SPU/DPD Directors’ Rule titled “Seattle Stormwater Manual” at “Volume 4 – Source Control,” to the extent necessary to prevent prohibited discharges as described in subsection 22.802.020.A through subsection 22.802.020.D, and to prevent contaminants from coming in contact with drainage water or being discharged to the drainage system, public combined sewer, or directly into receiving waters:</i></p> <ol style="list-style-type: none"> <i>1. <u>Fueling at dedicated stations, for new or substantially altered fueling stations.</u></i> <i>2. <u>Mobile fueling of vehicles and heavy equipment.</u></i> <i>3. <u>In-water and over-water fueling.</u></i> <i>4. <u>Maintenance and repair of vehicles and equipment.</u></i> <i>5. <u>Concrete and asphalt mixing and production.</u></i> <i>6. <u>Concrete pouring, concrete/asphalt cutting, and asphalt application.</u></i> <i>7. <u>Recycling, wrecking yard, and scrap yard operations.</u></i> <i>8. <u>Storage of liquids in aboveground tanks.</u></i> 	<ul style="list-style-type: none"> ● <u>None provided</u>

2.2.1. BMP 910: Fueling at Dedicated Stations

This BMP applies to businesses and public agencies that operate a facility used exclusively for the transfer of fuels from a stationary pumping station to vehicles or equipment. This type of fueling station includes aboveground or underground fuel storage facilities, which may be permanent or temporary. Fueling stations include facilities such as, but not limited to, commercial gasoline stations, 24-hour convenience stores, car washes, warehouses, manufacturing establishments, maintenance yards, port facilities, marinas and boatyards, construction sites, and private fleet fueling stations.

Description of Pollutants

Typically, stormwater contamination at fueling stations is caused by leaks or spills of fuels, lubrication oils, radiator coolants, fuel additives, and vehicle washwater. These materials contain organic compounds, oils and greases, and metals that can be harmful to humans and aquatic life. These pollutants must not be discharged to the drainage system or directly into receiving water.

A spill can be a one-time event, a continuous leak, or frequent small spills. All types must be addressed.

Required BMP Elements

All BMPs related to fueling at dedicated stations must be consistent with the requirements of the Seattle Fire Code (SMC, Chapter 22.600). The water quality requirements presented in this manual are separate from, and in addition to, the requirements of the Seattle Fire Code. These water quality requirements relate to fuel storage tanks, fuel dispensing equipment, area lighting, spill control and secondary containment, signage, maintenance, and operations. For current requirements, refer to the Seattle Fire Code.

New or substantially altered stations* require the following (refer to Figure [37](#)):

*Substantial alteration of fueling stations includes replacing the canopy or relocating, replacing, or adding one or more fuel dispensers in such a way that the Portland cement concrete (or equivalent) paving in the fueling area is modified. Addition of fuel tanks to a site also triggers implementation of source control BMPs. ~~For further guidance on determining the actions considered substantial remodeling, contact the Department of Planning and Development (DPD).~~

- Construct fueling stations on an impervious concrete pad under a roof to keep out rainfall and to prevent stormwater run-on. Pave the fueling island and containment pad with Portland cement concrete or equivalent. Asphalt is not considered an equivalent material.
- ~~Use an oil control treatment BMP for contaminated stormwater and wastewater in the fueling containment area with discharge to the sanitary sewer. Alternatively, discharge to a dead-end sump.~~

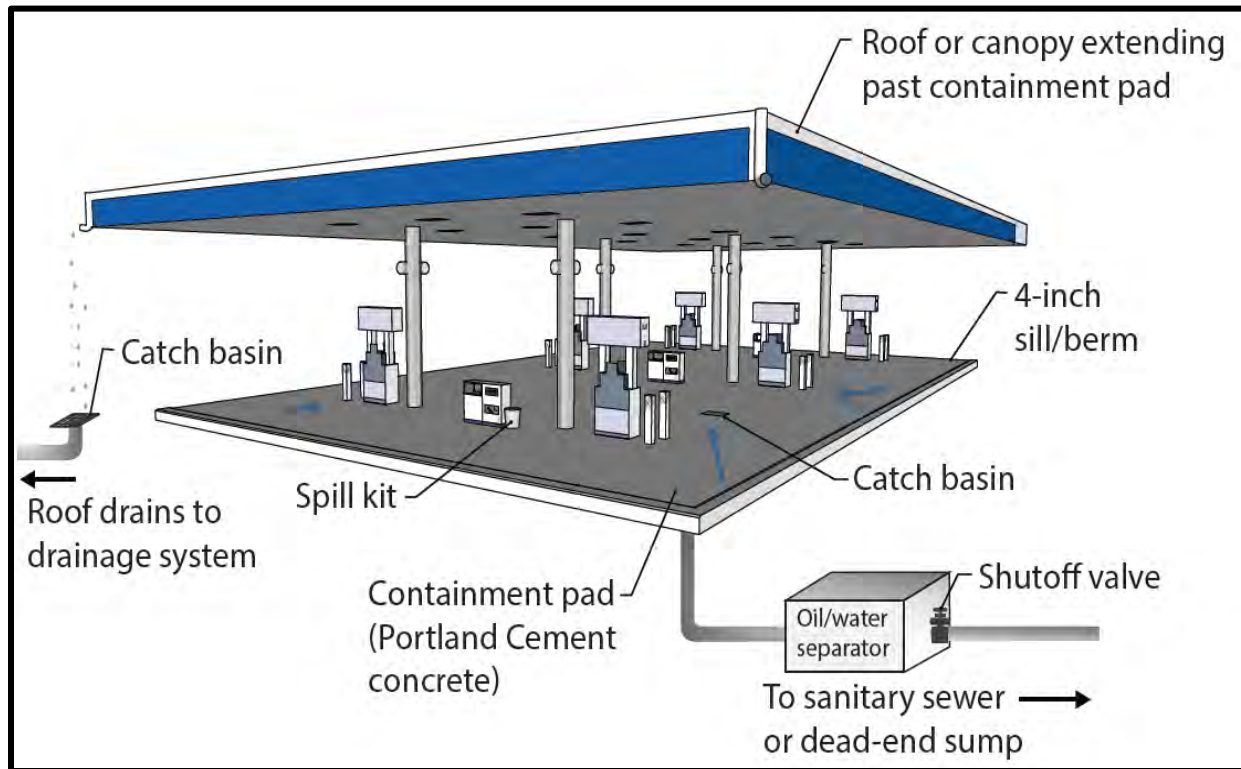

Figure 37. Fueling Island Schematic.

- Design the fueling island (Figure 48) to minimize stormwater contamination, to control spills, and to collect and direct contaminated stormwater and/or wastewater to a pretreatment facility that will achieve the performance goal per [Section 3.5.2.1- \(Oil Control Treatment\) in Volume 3 – Project Stormwater Control](#) ~~required level of treatment~~. The fueling island must be designed in compliance with all applicable codes.
- ~~Drains from the fueling island must discharge to the sanitary sewer or to a dead-end sump.~~
- The fueling island spill containment pad must be designed with the following:
 - A sill/berm (or equivalent control) raised to a minimum of 4 inches to contain spilled liquids and to prevent the run-on of stormwater from the surrounding area. Raised sills are not required at open-grate trenches that connect to an approved drainage control system.
 - A concrete containment pad ~~sloped~~ around the fueling island [that is sloped](#) toward the fuel [containment](#) pad drains. The slope of the drains must not be less than 1 percent.
 - [Drains from the fueling island containment pad must discharge to the sanitary sewer, combined sewer, or a dead-end sump. Provide drainage using trench drains and/or catch basins to collect spilled liquids and any contaminated stormwater runoff from the fuel island containment pad and convey it to either \(1\) the sanitary sewer—if approved by SPU and King County—through an approved pretreatment system such as an oil/water separator, or \(2\) a dead-end sump so that it can be held for proper off-site disposal.](#)

- ~~Collect runoff from the fuel island containment pad and convey it to either (1) the sanitary sewer if approved by SPU and/or King County using an oil/water separator or (2) hold for proper offsite disposal.~~
 - For discharges to the sanitary sewer, a catch basin must shall be installed upstream of the oil/water separator.
 - ~~The~~ If a dead-end sump is used, it must be easily inspected.
 - Collected runoff from the fuel island containment pad discharged to the sanitary sewer must comply with Seattle Municipal Code SMC, Section 21.16.300 – Prohibited discharge of certain substances. Comply with pretreatment regulations prohibiting discharges that could cause a fire or explosion (WAC, Section 173-216-060).
 - The minimum spill retention volume of the oil/water separator or dead-end sump (i.e., volume of spilled fuel contained before the structure overflows) shall must be sized as follows:
 - ~~(1) For a covered fuel pad:~~ 15 minutes for the flow rate of the dispensing mechanism with the highest through-put rate, ~~or~~
 - ~~(2) For if the an uncovered area is uncovered, or an area that receives run-on from an uncovered area:~~ the 15-minute peak flow rate of the 6-month, 24-hour storm event (or 91 percent of the total runoff volume for the simulation period if using continuous runoff modeling) over the surface of the containment pad, ~~–~~ whichever is greater plus the volume required for a covered fuel pad.

The minimum volume of the spill containment sump ~~must should~~ be ~~a minimum of~~ 50 gallons with an adequate grit sedimentation volume. The spill retention/containment volume of the oil/water separator must retain the required spill volume when the oil/water separator is full of water. Dead-end sumps must not be used when the fuel containment area is uncovered or will receive run-on from other areas unless approved by the Director of SPU.

Note: To calculate the fuel containment capacity, determine the volume of fuel retention on the basis of the retained water volume in the bottom of the oil/water separator bottom and the density of fuel. Fuel containment will be above the static water level into the normal headspace of the oil/water separator (i.e., floating on top of the retained water volume) when the automatic shutoff valve is closed. Subtract the retained water volume in the oil/water separator from the overall volume of the oil/water separator to determine the spill retention volume.

 - For further requirements and guidance related to the storage of fuel-contaminated stormwater, refer to BMP 1626 in Section 2.1.163.4.5.
 - ~~For discharges to the sanitary sewer or combined sewer, an automatic shutoff valve is required at the discharge point of the oil/water separator. The valve at the discharge point must be closed in the event of a spill. For discharges to the sanitary sewer, an automatic shutoff valve is required at the discharge point of the oil water separator. The valve must be closed in the event of a spill. The spill control sump must be sized in compliance with the Seattle Fire Code and the International Fire Code. For more information, contact the Seattle Fire Department (206) 386-1400.~~

- When an oil-stop valve or resin plug valve is ~~utilized~~^{used}, it must be engineered to be at least as protective as an automatic ~~shutoff~~^{shut-off} valve ~~above~~.
- Construct a roof or canopy over the fueling island to prevent precipitation from falling directly onto the spill containment pad (Figure 48). The roof or canopy must:
 - At a minimum, cover the spill containment pad (within the grade break or fuel dispensing area) and preferably extend several additional feet to reduce the introduction of windblown rain.
 - Roofs and canopies 10 feet or less in height must have a minimum overhang of 3 feet on each side. The overhang must be measured relative to the berm or other hydraulic grade break.
 - Roofs or canopies greater than 10 feet in height must have a minimum overhang of 5 feet on each side.



Figure 48. Roof at Fueling Island to Prevent Stormwater Run-On.

- Convey runoff collected in roof or canopy drains to a drainage system or receiving water outside the fueling containment area. This will prevent the mixing of uncontaminated runoff from the roof with contaminated runoff from the fueling island.
- A roof or canopy may not be practical at fueling stations that regularly fuel vehicles 10 feet in height or more, particularly at industrial or transportation sites. Additional BMPs or equivalent measures are required. At these types of fueling facilities, the following BMPs apply, as well as all of the other required BMPs and fire prevention requirements (Seattle Fire Code and Uniform Fire Code):

- The concrete fueling pad must be equipped with an emergency spill control device that includes a shutoff valve for drainage from the fueling area.
- The shutoff valve must be closed in the event of a spill. An automatic shutoff valve is preferred required to minimize the time lapse between spill and containment.

Obtain all necessary permits for installing, altering, or repairing side sewers. Restrictions on certain types of discharges may require pretreatment before they enter the sanitary sewer.

The following BMPs or equivalent measures are required for all fueling stations:

- Implement ~~all citywide~~ BMPs 1 through BMP 8 for all real property (refer to Section 2.1 ~~Chapter 2~~).
- Train employees on the proper use of fuel dispensers.
- Do not use dispersants to clean up spills or sheens.
- Post signs related to the operation of fuel dispensers in accordance with the Seattle Fire Code. For example, post “No Topping Off” signs near fuel dispensers (topping off gasoline tanks results in spillage and vents gasoline fumes to the air).
- Ensure that the person conducting the fuel transfer is present at the fueling dispenser/fueling pump during fuel transfer, particularly at unattended or self-service stations. Post “Stay with Vehicle during Fueling” signage near fuel dispensers.
- Ensure that the automatic shutoff on the fuel nozzle is functioning properly.
- Ensure that at least one designated trained person is available either on site or on call at all times to promptly and properly implement spill prevention and cleanup. If the fueling station is unattended, the spill plan must be visible to all customers using the station, and the spill kit must also be accessible and fully stocked at all times.
- Keep suitable cleanup materials, such as dry adsorbent materials, on site to enable employees to promptly clean up spills.
- Transfer the fuel from the delivery tank trucks to the fuel storage tank in impervious contained areas and ensure that appropriate overflow protection is used. Alternatively, cover Cover nearby inlets/catch basins during the filling process and use drip pans under all hose connections.

~~The following additional BMPs or equivalent measures are required for fueling over open water, such as at marinas or boatyards:~~

- ~~• Have an employee supervise the fuel dock.~~
- ~~• Use automatic shut-off nozzles and promote the use of “whistles” and fuel/air separators on air vents or tank stems of inboard fuel tanks to reduce the amount of fuel spilled into receiving waters during fueling of boats.~~
- ~~• During fueling operations, visually monitor the liquid level indicator to prevent the tank from being overfilled.~~
- ~~• The maximum amount of product received must not exceed 95 percent capacity of the receiving tank.~~
- ~~• Spilled fuel and contaminated stormwater must be conveyed either to the sanitary sewer if approved by SPU and/or King County or to an oil removal treatment facility.~~

~~such as an American Petroleum Institute (API) oil/water separator, coalescing plate oil/water separator, or equivalent treatment and then to a basic treatment facility (refer to Volume 3—Project Stormwater Control).~~

~~Facilities and procedures for the loading or unloading of petroleum products must comply with U.S. Coast Guard requirements. Refer to specifications in the Stormwater Management Manual for Western Washington (SWMMWW), Volume IV-D (Ecology 2014).~~

Recommended BMPs

- ~~● Provide information to all appropriate parties on collection and recycling programs for oil, oil absorbing pads, and oil filters.~~
- ~~● Direct all appropriate parties to the proper disposal of all used hydrocarbon products through the use of signs, mailings, and other means.~~

2.1.8.2.2.2. BMP 1012: Mobile Fueling of Vehicles and Heavy Equipment

This BMP applies to businesses and public agencies that fill fuel tanks of vehicles and equipment by means of tank trucks driven to sites where the vehicles are located (also known as mobile fueling, fleet fueling, wet fueling, or wet hosing).

Description of Pollutants

Typically, stormwater contamination at mobile fueling locations is caused by leaks or spills of fuels and automotive fluids. These materials contain organic compounds, oils and greases, and metals that can be harmful to humans and to the aquatic environment. These pollutants must not be discharged to the drainage system or directly into receiving waters.

Required BMP Elements

The following BMPs or equivalent measures are required of all businesses (organizations or individuals) and public agencies that conduct mobile fueling of vehicles and heavy equipment:

- Implement ~~all citywide~~ BMPs 1 through BMP 8 for all real property (refer to Section 2.1 Chapter 2).
- Mobile fueling operations must be permitted by the Seattle Fire Department ~~and comply with both the Seattle Fire Code and Washington State Fire Code~~.
- In fueling locations near sensitive aquifers, designated wetlands, wetland buffers, or other receiving water, compliance with additional local requirements may be required.
- ~~Ensure compliance with all 49 CFR 178 requirements for Department of Transportation (DOT) 406 cargo tankers. Documentation from a DOT Registered Inspector is required to provide proof of compliance.~~
- Train the driver/operator annually in spill prevention and cleanup. Make all employees aware of the significant liability associated with fuel spills. New employees must be trained upon hiring. Document and keep all training records.
- Develop and follow a written fuel operation plan that is:
 - Properly signed and dated by the responsible manager
 - Retained at headquarters and distributed to all operators, along with the spill plan
 - Made available in the event that an authorized government agency requests a review
- Ensure that the driver/operator is present and constantly observing and monitoring the fuel transfer location during fuel transfer. Implement the following procedures at fuel transfer locations:
 - To the extent practical, locate the point of fueling at least 25 feet from the nearest inlet/catch basin or inside an impervious containment area with a volumetric holding capacity equal to or greater than 110 percent of the fueling tank volume, or cover the inlet/catch basin to ensure there is no inflow of spilled or leaked fuel. Before removing drain cover, check for sheen. Do not remove if sheen is present and properly dispose of contaminated material.

- Place a drip pan or an absorbent pad under each fueling location prior to and during all dispensing operations. The pan must be watertight and must have a [minimum](#) capacity of 5 gallons.
- Handle and operate fuel transfer hoses and nozzles, drip pan(s), and absorbent pads to prevent fuel spills and leaks from reaching the ground, receiving water, and inlets/catch basins.
- Avoid extending the fueling hoses across a traffic lane without a cone barrier and do not allow vehicles to drive over fuel hoses.
- Do not “top off” fuel tanks.
- Use automatic shutoff nozzles for dispensing the fuel. Replace automatic shutoff nozzles as recommended by the manufacturer.
- Inspect, maintain, and replace equipment on fueling vehicles, particularly hoses and nozzles, at established intervals to prevent failures. Document and keep all inspection records on file.
- Use an adequate lighting system at the filling point.
- At a minimum, maintain the following spill cleanup materials in a readily accessible location in all fueling vehicles:
 - Non-water-absorbent materials capable of absorbing 15 gallons of diesel fuel
 - An inlet/catch basin plug or cover
 - A non-water-absorbent containment boom at least 10 feet long with a 12-gallon absorbent capacity
 - A non-spark-generating shovel
 - [Adequate means to hold spent absorbents generated by a 15-gallon spill for disposal.](#)
 - ~~Two 5-gallon buckets with lids~~
- Immediately remove and properly dispose of [fuel-contaminated](#) soils with visible surface contamination to prevent the spread of chemicals to groundwater or receiving water via stormwater runoff.
- Immediately notify the Seattle Fire Department (911), the Ecology Northwest Regional Office (425) 649-7000, and SPU (206) 386-1800 in the event of a spill. Establish a “call down list” to ensure the rapid and proper notification of management and government officials if any significant amount of product is discharged from the site. Keep the list in a protected but readily accessible location in the mobile fueling truck. The “call down list” should also identify spill response contractors available in the area to ensure the rapid removal of significant product spills into the environment. [Include this bullet item in the fuel operation plan.](#)
- Do not use dispersants to clean up spills or sheens [unless they will be picked up for proper disposal.](#)

2.2.3. BMP 11: In-Water and Over-Water Fueling

This BMP apply to businesses and public agencies that operate a facility used for the transfer of fuels from a stationary station to vehicles or equipment in water.

Description of Pollutants

In-water and over-water fueling can result in leaks or spills of fuels and associated petroleum products that can be harmful to humans and aquatic life.

Required BMP Elements

Required BMP elements are contained in S439 – *BMPs In-Water and Over-Water Fueling* in Volume IV of the SWMMWW (Ecology 2019).

2.1.9.2.2.4. *BMP 1211: Maintenance and Repair of Vehicles and Equipment*

This BMP applies to businesses and public agencies on whose premises oil, fuel, engine oil, and other fluids such as battery acid, coolants, and transmission and brake fluids are removed and replaced in vehicles and equipment. It also applies to mobile vehicle maintenance operations.

Description of Pollutants

Pollutants of concern are total petroleum hydrocarbons, toxic organic compounds, oils and greases, pH, and metals. These pollutants must not be discharged to the drainage system or directly into receiving waters.

Required BMP Elements

The following BMPs or equivalent measures are required of all businesses and public agencies engaged in vehicle and equipment repair and maintenance activities:

- Implement ~~all citywide BMPs~~ BMP 1 through BMP 8 for all real property (refer to Section 2.1 ~~Chapter 2~~).
- Inspect all incoming vehicles and equipment for leaks and spills. Clean up all leaks and spills as they occur. Drain all fluids that have the potential to leak from wrecked vehicles and from equipment when they arrive. Store and dispose of fluids properly.

A spill can be a one-time event, a continuous leak, or frequent small spills. All types must be addressed as prescribed in BMP 5 (Spill Prevention and Cleanup).

- ~~Ensure that spill control materials that are appropriate to the type and quantity of materials being stored are kept readily accessible and stocked for ease of use. Soiled rags and other cleanup material must be properly disposed of or professionally cleaned and reused.~~
- Maintenance and repair activities must be conducted inside a building or other covered impervious containment area that is sloped to prevent run-on of uncontaminated stormwater and runoff of contaminated water. If an emergency situation requires immediate repair outside, containment devices must be used.
- ~~Do not use dispersants to clean up spills or sheens.~~
- ~~Use drip pans or other containment devices beneath the vehicle or equipment to capture all spills and drips.~~
- Make sure all outside materials that have the potential to leach or spill to the drainage system are covered and contained, or moved to an indoor location.
- Maintenance and repair areas cannot be hosed down. Instead, they must be swept weekly or more often as needed to collect dirt. ~~Spills must be wiped up with rags and other absorbent materials. If pressure washing is necessary, the wastewater must be collected and disposed of properly. It cannot be discharged to the drainage system.~~

- Wastes, such as washwater, may not be discharged to the stormwater system or receiving waters except as conditionally allowed in SMC, Section 22.802.030. Do not discharge vehicle fluids to the drainage system, sanitary sewer, or receiving waters. Do not pour or convey washwater, liquid waste, or other pollutants into the drainage system.
- Maintenance and repair shop floor drains must discharge to the sanitary sewer. Do not allow drains inside maintenance buildings to connect to the sanitary sewer without prior approval by SPU, ~~and/or~~ King County, or both.
- If extensive staining and oily sheen ~~is~~are present, absorbent pillows or booms must be used in or around catch basins and properly maintained to prevent oil from entering the drainage system. If operational BMPs are insufficient to prevent and manage recurrent oily discharges, then structural source control measures may be required.

2.1.10-2.2.5. *BMP 13: Concrete and Asphalt Mixing and Production*

This BMP applies to businesses and public agencies that mix raw materials onsite to produce concrete or asphalt.

Description of Pollutants

Pollutants of concern include petroleum hydrocarbons, toxic organic compounds, oils and greases, metals, and pH. Not only can concrete pouring activities severely alter the pH of stormwater runoff, but slurry from aggregate washing can harden in drainage infrastructure, thereby reducing capacity, which can result in flooding. These pollutants must not be discharged to the drainage system or directly into receiving waters.

Required BMP Elements

Activities associated with concrete and asphalt mixing and production may require an NPDES permit from Ecology. Refer to Ecology's website (<https://ecology.wa.gov/Regulations-Permits/Permits-certifications/Stormwater-general-permits> www.ecy.wa.gov/programs/wq/stormwater/index.html) or call Ecology at (360) 407-6000 to determine if the site activities trigger permit coverage.

The following BMPs or equivalent measures are required of all businesses and public agencies engaged in activities related to concrete and asphalt mixing and production at stationary sites:

- Implement ~~all citywide BMPs~~ [BMP 1 through BMP 8 for all real property](#) (refer to [Section 2.1](#)~~Chapter 2~~).
- ~~Cover production areas and pouring areas~~ to protect them from contact with stormwater.
- Recycle all process water from production, pouring, and equipment cleaning or discharge it to a dead-end sump, process water treatment system, or the sanitary sewer. Obtain all necessary permits for discharge to the sanitary sewer.
- Never discharge washout from fresh concrete or concrete mixing into streets, sidewalks, drainage systems, or receiving waters.
- Segregate production areas from stormwater inputs. Any stormwater that mixes with production areas is considered process water and cannot be discharged to the drainage system or receiving waters. Obtain all necessary permits for discharge to the sanitary sewer.
- Establish a BMP maintenance schedule and educate employees annually about the need to prevent stormwater contamination through regular BMP maintenance. Document and keep all maintenance training records on hand.
- Use absorbent materials or catch basin filter socks (Figure 5) in and around inlets/catch basins to help filter out solids. If catch basin filter socks are used, maintain the filters regularly (weekly or as needed) to prevent plugging. Stormwater contaminated with concrete or asphalt must not enter the drainage system.

Catch basin filter socks only remove solids and do not provide treatment for other pollutants associated with concrete and asphalt mixing and production.

- Sweep the production and pouring area, driveways, gutters, and all other outdoor areas daily or more often as necessary to collect fine particles and aggregate for recycling or proper disposal.



Figure 5. Commercially Available Catch Basin Filter Sock.

- Do not wash or hose down areas that flow to the drainage system.
- Make sure all outside materials that have the potential to leach or spill to the drainage system are covered, contained, or moved to an indoor location.
- [Collect, treat, and properly dispose of runoff that comes in contact with release agents.](#)
- If operational controls do not prevent stormwater contamination, treatment BMPs may be necessary.

For information about water quality treatment BMPs for activities related to concrete and asphalt mixing and production at stationary sites, refer to *Volume 3 – Project Stormwater Control*. For a current list of proprietary and emerging water quality treatment technologies, refer to Ecology's website (<https://ecology.wa.gov/Regulations-Permits/Guidance-technical-assistance/Stormwater-permittee-guidance-resources/Emerging-stormwater-treatment-technologies> www.ecy.wa.gov/programs/wq/stormwater/newtech/index.html).

Recommended BMPs

Although not required, the following BMPs are recommended to further prevent and minimize the contamination of stormwater resulting from concrete and asphalt mixing and production activities:

- Pave the mixing ~~and,~~ production, ~~and pouring~~ areas. A sump drain in these areas is not advisable due to potential clogging problems, ~~but could be used in a curing area.~~ Sweep these areas to remove loose aggregate and recycle or properly dispose of the aggregate ~~properly.~~
- Use catch basin covers or similarly effective containment devices to prevent runoff from entering the drainage system.

~~2.1.11.2.2.6.~~ ***BMP 14: Concrete Pouring, Concrete/Asphalt Cutting, and Asphalt Application***

This BMP applies to businesses and public agencies that apply asphalt or pour or cut concrete or asphalt for building construction and remodeling; road construction; repair and construction of sidewalks, curbs, and gutters; sealing of driveways and roofs; and other applications.

Description of Pollutants

Pollutants of concern include petroleum hydrocarbons, toxic organic compounds, oils and greases, metals, suspended solids, and pH. Not only can concrete pouring activities severely alter the pH of stormwater runoff, but slurry from aggregate washing can harden in stormwater pipes, thereby, reducing their capacity and resulting in flooding. These pollutants must not be discharged to the drainage system or directly into receiving waters.

Required BMP Elements

The following BMPs or equivalent measures are required of all businesses and public agencies engaged in activities related to concrete pouring and cutting and asphalt application:

- Implement ~~all citywide BMPs~~ [BMP 1 through BMP 8 for all real property](#) (refer to [Section 2.1](#) ~~Chapter 2~~).
- Sweep or shovel and collect loose aggregate chunks and dust for recycling or proper disposal at the end of each workday or as needed, especially at work sites such as streets, driveways, parking lots, sidewalks, curbs, and gutters where rain can readily pick up the loose material and carry it to the nearest stormwater conveyance system. Never hose down concrete or asphalt waste materials to an inlet/catch basin, ditch or receiving water.
- Place catch basin covers or similarly effective containment devices over all nearby drains at the beginning of each workday.
- Shovel and/or vacuum all slurry and remove from the site. All accumulated runoff and solids must be collected and properly disposed of at the end of each workday, or more often if necessary.
- Make sure all outside materials that have the potential to leach or spill to the drainage system are covered, contained, or moved to an indoor location.
- Use a mechanism for containment and collection of the discarded concrete slurry when performing exposed aggregate washing, where the top layer of unhardened concrete is hosed or scraped off to leave a rough finish. Dispose of the slurry properly.
- Use a catch basin filter sock to remove solid materials from inlets/catch basins. Maintain the filter regularly to prevent plugging. Stormwater contaminated with concrete or asphalt must not enter the drainage system.
- Perform cleaning of concrete application and mixing equipment or concrete delivery vehicles in a designated area where the rinse water can be controlled and properly disposed of.

- Collect, treat, and properly dispose of runoff that comes in contact with diesel or coatings used in asphalt applications, [cleanup, or transportation](#).
- [Collect, treat, and properly dispose of runoff from cutting activities.](#)

~~For information about water quality treatment BMPs related to concrete and asphalt mixing and production activities, refer to Volume 3— Project Stormwater Control. For a current list of proprietary and emerging water quality treatment technologies, refer to Ecology’s website (www.ecy.wa.gov/programs/wq/stormwater/newtech/index.html).~~

Recommended BMPs

Although not required, the following BMPs are recommended to further prevent and minimize the contamination of stormwater resulting from concrete pouring and cutting and asphalt application at temporary sites:

- Avoid the activity when rain is falling or expected.
- If possible, portable asphalt mixing equipment should be covered by an awning, a lean-to, or other simple structure to avoid contact with rain.
- Recycle broken concrete and asphalt. Search for “Recycling Services” online ~~or in the Yellow Pages of the telephone book~~ to find a local recycler.

2.1.12-2.2.7. BMP 1524: Recycling, Wrecking Yard, and Scrap Yard Operations

This BMP applies to businesses and public agencies that reclaim various materials for resale or for scrap, such as vehicles, parts of vehicles, equipment, construction materials, metals, beverage containers, electronic waste and papers. Activities that can generate pollutants include the following: transfer, dismantling, and crushing of vehicles and scrap metal; transfer and removal of fluids; maintenance and cleaning of vehicles, parts, and equipment; and storage of fluids, parts for resale, solid wastes, scrap parts, materials that are contaminated or contain fluids, equipment, and vehicles that contain fluids.

Description of Pollutants

Potential sources of pollutants include paper, plastic, metal scrap debris, engines, transmissions, radiators, batteries, and other materials that contain fluids or are contaminated with fluids. Other pollutant sources include leachate from metal components, contaminated soil, and eroded soil.

Potential pollutants typically found at vehicle recycling and scrap yards include oils and greases, ethylene glycol, propylene glycol, suspended solids, [polychlorinated biphenyls \(PCBs\)](#), phthalates, substances that increase biological oxygen demand (BOD), metals (including mercury), and low (acidic) pH. [PCB sources can include lamp ballasts, capacitors from white goods, transformers, or other electrical equipment.](#)

Required BMP Elements

Recycling, wrecking yard or scrap yard activities may require an NPDES permit from Ecology. Refer to Ecology's website (<https://ecology.wa.gov/Water-Shorelines/Water-quality/Runoff-pollution/Stormwater> <http://www.ecy.wa.gov/programs/wq/stormwater/index.html>) or call Ecology at (360) 407-6000 to determine if the site activities trigger permit coverage. If the permit is required, refer to Publication 94-146, Vehicle and Metal Recyclers: A Guide for Implementing the Industrial Stormwater General National Pollutant Discharge Elimination System Permit Requirements (Ecology 2011), for the selection of BMPs.

At a minimum, the following BMPs or equivalent measures are required for activities related to recycling, wrecking yard, and scrap yard operations. Additional BMPs may be required for businesses and public agencies subject to Ecology's Industrial Stormwater General Permit.

- Implement ~~all citywide BMPs~~ [BMP 1 through BMP 8 for all real property](#) (refer to [Section 2.1](#) ~~Chapter 2~~).
- Drain all fluids upon arrival, prior to storage or disposal.
- Inspect all items for leakage or potential leaks. Use drip pans or other containment where necessary to prevent leaks from reaching the ground or drainage systems. Do not hose pollutants from any area to the ground or into drainage systems.
- Make sure all outside materials that have the potential to leach or spill to the drainage system are covered, contained, or moved to an indoor location.

- Keep all containers, including dumpsters and scrap collection bins, under cover or fit them with a lid that must be kept closed when the container is not in use. Empty bins may have residual pollutants from previous contents and must be covered when stored outside.
- Areas used for processing material to be recycled or for draining/transferring fluid should be designed to stop run-on and to contain all fluids that may be spilled or released. Use cover and containment options such as an enclosed building or roof, and berms or dikes. If there is a sump, dispose of waste properly or recycle accordingly.
- For fluids stored in containers, the containers must be rigid, durable, resistant to corrosion due to the weather and fluid contents, water-tight, and equipped with a tight-fitting lid able to retain the contents in the event of tipping. Place containers/drums in covered impervious secondary containment areas. Store fluids in steel or plastic drums that are rigid and durable, resistant to corrosion from the weather and fluid content, water tight and equipped with a tight fitting lid. Store batteries properly.
- Label all containers/tanks with their contents and identify the hazard they pose. Handle all dangerous and/or hazardous materials and waste in accordance with SPU, King County, and Ecology's requirements.
- Prevent track out from the site onto the adjacent roadway.
- If operational BMPs are not sufficient to prevent stormwater contamination, structural controls must be implemented, including treatment or structural containment. Structural controls must be implemented for new or redeveloped facilities to prevent prohibited discharges to the public drainage system, the private drainage system, receiving waters (refer to SMC, Section 22.802.020), or the public sewer system (refer to SMC, Section 21.16.300).
- For facilities subject to Ecology's Industrial Stormwater General Permit, refer to Vehicle and Metal Recyclers: A Guide for Implementing the Industrial Stormwater General National Pollutant Discharge Elimination System Permit Requirements (Ecology 2011). Apply the BMPs in that guidance document to scrap material recycling facilities, depending on the pollutant sources at those facilities.
- Check incoming scrap materials, vehicles, and equipment for potential fluid contents and batteries.
- Remove batteries and store them in a leak-proof container and under cover.
- Cover and raise above the ground surface any materials that may contaminate stormwater. A tarpaulin and pallet are acceptable.
- Storage of flammable and combustible materials must comply with the appropriate fire codes.
- Develop and implement a BMP inspection log to be used daily. Keep all records on file.
- Inspect storage areas regularly and promptly clean up any leaks, spills, or contamination.
- Sweep paved storage areas daily or more often as needed to remove accumulated dust and pollutants. Inspect storage areas often and maintain good housekeeping.

- Keep spill cleanup materials in a central location. Ensure that employees are familiar with the site's spill control plan and/or proper spill cleanup procedures. Restock spill cleanup supplies after each use.

2.2.8. BMP 1626: Storage of Liquids in Aboveground ~~Above-ground~~ Tanks

This BMP applies to businesses and public agencies that have on their premises ~~aboveground~~~~above-ground~~ tanks that contain liquids (excluding uncontaminated water). These tanks may be equipped with a valved drain, vent, pump, and bottom hose connection. These include, but are not limited to, commercial aboveground heating oil tanks; gasoline and diesel tanks; food products; or process water.

Description of Pollutants

Pollutant sources include leaks and spills that can occur at connections and during liquid transfer. Oils and greases, organic compounds, acids, alkalis, and metals in tank water and condensate drainage can also result in stormwater contamination.

Required BMP Elements

The following BMPs or equivalent measures are required for activities related to the storage of liquids in aboveground tanks:

- ~~Implement all citywide~~ BMPs 1 through BMP 8 for all real property (refer to Section 2.1~~Chapter 2~~).
- Provide secondary containment or use a double-~~walled~~ tank.
- Do not discharge contaminated stormwater within the secondary containment area to the drainage system. Evidence of contamination can include the presence of visible sheen, smell, color or turbidity in the runoff, or existing or historical operational problems at the facility. Check for acceptable pH ranges for areas subject to acid or alkaline contamination. Develop appropriate screening techniques for water-miscible contaminants such as test strips or laboratory testing.
- Implement the following maintenance activities to prevent and minimize stormwater contamination:
 - Inspect tank containment areas regularly to identify problems (e.g., cracks, corrosion, leaks) with components such as fittings, pipe connections, and valves.
 - Replace or repair tanks that are leaking, corroded, or otherwise deteriorating. Document and keep all inspection records. A soundness evaluation by a Professional Engineer may be requested to confirm tank stability.
 - Sweep and clean the tank storage area regularly.
- For new and redeveloped sites, locate and design tanks to prevent and minimize stormwater contamination:
 - Locate permanent tanks ~~on~~~~in~~ an impervious (Portland cement concrete or equivalent) ~~spill~~~~secondary~~ containment ~~pad~~~~area~~. All exposed containment surfaces within the containment area must be impervious to all material in the tanks.
 - Surround the ~~spill~~ containment ~~pad~~~~area~~ with dikes or walls ~~(as illustrated in Figure 15)~~ or provide double-~~walled~~ tanks approved by the Underwriters Laboratory (UL). Design the dike to be of sufficient height to provide a containment volume of either 10 percent of the total volume of the enclosed tanks

or 110 percent of the volume of the largest tank, whichever is greater. If a single tank, the dike must be able to hold 110 percent of the volume of that tank.

- ~~Slope covered secondary containment pads so they will ~~to~~ drain to a dead-end sump or equivalent for the collection of small spills.~~
- If the tank containment area is not covered, equip the outlet from the spill-containment sump with a shutoff valve. The valve should only be opened to convey contaminated stormwater to an approved treatment system or disposal facility or to convey uncontaminated stormwater to the drainage system.
- ~~Evidence of contamination can include the presence of visible sheen, color or turbidity in the runoff, or existing or historical operational problems at the facility. Check for acceptable pH ranges for areas subject to acid or alkaline contamination. If contamination is present, discharge to the treatment system.~~
- Place adequately sized drip pans beneath all mounted taps and locations where drips and spills might occur during the filling and draining/unloading of tanks.
- Include a tank overfill protection system to minimize the risk of spillage during loading.
- In areas with multiple ~~At~~ petroleum product storage tanks ~~farms~~, convey stormwater through an American Petroleum Institute (API) oil/water separator, coalescing plate oil/water separator, or other approved treatment system with an automatic shutoff valve or oil stop valve prior to discharge to the sanitary sewer. Oil stop valves must be selected on the basis of the type of petroleum product stored in the tank(s).

CHAPTER 3 – ~~COMMERCIAL AND~~ INDUSTRIAL BUSINESS AND PUBLIC ENTITY ~~ACTIVITY~~ BEST MANAGEMENT PRACTICES FOR SPECIFIC ACTIVITIES

In addition to ~~the citywide~~ BMPs 1 through BMP 8 for all real property (Section 2.1) and BMP 9 through BMP 16 for specific activities for all real property (Section 2.2)~~in Chapter 2~~, there are many additional source control BMPs that may be required depending on the specific ~~commercial and industrial~~ activities that occur or will occur on a site at a business or a public entity, except those ~~the that~~ drain only to the combined sewer. Source control requirements are outlined in Seattle Municipal Code (SMC), Section 22.803.040 (Minimum Requirements for Source Controls for All Businesses and Public Entities) and SMC, Section 22.805.020.K (Install Source Control BMPs).

Before reading this chapter, fill out the worksheet in *Section 1.6* to identify which site-specific activities require BMPs.

3.1. Cleaning or Washing

The cleaning or washing of vehicles, aircraft, vessels, engines, tools, cooking equipment, manufacturing equipment, and buildings are pollution generating activities when not conducted properly. When these activities are performed, the resulting washwater usually contains soap or detergents, and can contain a variety of pollutants that contaminate stormwater. The specific BMPs that apply to cleaning and washing are presented in this section.

The discharge from some maintenance activities may be allowed, provided they meet the conditions outlined in the Stormwater Code. Those maintenance activities include street and sidewalk washing and routine external building washdown. [Refer to](#) [See](#) the required provisions and conditions outlined in the Stormwater Code [\(SMC, Chapters 22.800 through 22.808\)](#).

Remember to also implement [all required citywide](#) BMPs [1 through BMP 8 for all real property](#) from [Section 2.1](#) [Chapter 2](#).

3.1.1. *BMP 178: Cleaning or Washing*

This BMP applies to cleaning, washing, and rinsing activities, including pressure washing and steam cleaning. The purpose of cleaning and washing activities is to remove pollutants from equipment, vehicles, boats and buildings; these pollutants should not be discharged to the public drainage system.

Description of Pollutants

Source pollutants include surfactants₇; petroleum hydrocarbons₇; toxic organic compounds₇; fats, oils₇ and greases₇; soaps₇; detergents₇; nutrients₇; metals₇; polychlorinated biphenyls (PCBs)₇; pH₇; suspended solids₇; substances that increase biological oxygen demand (BOD)₇; and substances that increase chemical oxygen demand (COD).

Required BMP Elements

The following BMPs or equivalent measures are required of all businesses and public agencies engaged in cleaning or washing activities:

- Implement all ~~citywide~~ BMPs 1 through BMP 8 for all real property (refer to Section 2.1 Chapter 2).
- Provide training to employees regarding proper disposal of wastewater. This training must be documented.
- Outside drains discharge to the combined sewer, directly to local waters, or to the public drainage system, depending on the location within Seattle. Directing washwater/washing activities in to drains that discharge to the drainage system or local waters is not allowed unless specifically identified as conditionally permitted. Identify the type of system on your property and train employees about required BMPs accordingly.
- ~~The following are conditionally permissible washing practices: (1) Discharges of street and sidewalk washwater when the surfaces have been swept prior to washing, detergents are not used, and water use is minimized; and (2) Discharges of water from routine external building washdown when detergents are not used and water use is minimized. These conditions must be met or the washing activity is prohibited. For cleaning related to food service establishment equipment, wipe the equipment before cleaning/washing to remove excess pollutants.~~
- Sweep surfaces before cleaning/washing to remove excess sediment and other pollutants.
- Discharge wastewater from cleaning or washing activities into the sanitary or combined sewer at a site that is if properly approved for discharge, into a process treatment system, or into a holding tank. It is illegal to discharge the dirty solution/washwater to the drainage system or local waters. A permit/Authorization for discharge to the sanitary or combined sewer may be required₇ and pretreatment may be necessary. If using a holding tank, ensure that it is properly sized and does not overflow.
- Cover and/or contain the washing activity or wash conduct the activity inside a building having a floor drain that discharges to the sanitary sewer.

- If roof equipment or hood vents are cleaned, ensure that no wastewater or [prohibited substance \(refer to SMC, Chapter 22.802\)](#) ~~process water~~ is discharged to the roof drains or drainage system.
- Label all mobile cleaning equipment as follows: “Properly dispose of all wastewater. Do not discharge to an inlet/catch basin, ditch, stream, or on the ground.”

Ecology Publication WQ-R-95-056, *Vehicle and Equipment Washwater Discharges: Best Management Practices Manual* (Ecology 2012) can be used for guidance on sumps, holding tanks, and the prevention of runoff.

For wash pads discharging directly to the sanitary sewer:

- The uncovered portion of the wash pad must be no larger than 200 square feet or must have an overhanging roof (refer to Figure 6). This is to prevent excess stormwater from entering the sanitary sewer. Covering may be required in many situations.



Figure 6. Car Wash Building with Drain to the Sanitary Sewer.

- If the uncovered wash pad cannot be less than 200 square feet, a shut off valve may be installed which will direct washwater to the sanitary sewer when the wash pad is in use, and stormwater to the drainage system when the wash pad is not in use (refer to Figure 7). The valve on the outlet may be manually operated; however, a pneumatic or electrical valve system is preferable. The valve may be on a timer circuit, where it

is opened upon completion of a wash cycle. The timer would then close the valve after the sump or separator is drained.

- [The wash pad must be clearly signed as to the operation and location of the valve.](#)
- [Conduct and annual training is required on operation of for this the valve system.](#)
- If adjacent to a building or constructed over hazardous material storage areas, other regulations, including the Seattle Fire Code, may apply.
- Obtain all necessary permits for installing, altering or repairing onsite drainage and side sewers. Restrictions on certain types of discharges may require pretreatment before they enter the sanitary sewer.

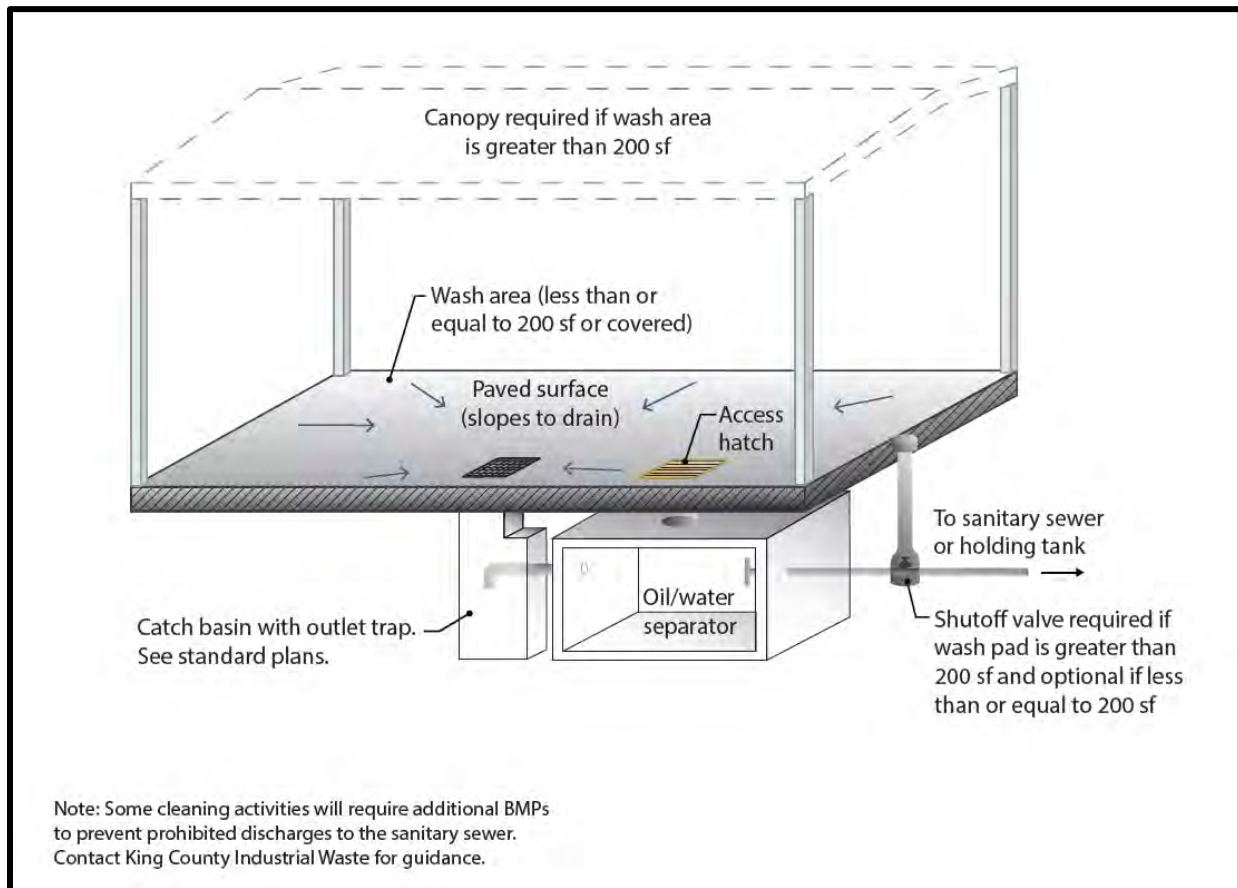

Figure 7. Schematic of Wash Pad with Sump.

Recommended BMPs

Although not required, the following BMPs can provide additional pollution control for washing activities that drain to the sanitary sewer. To reduce the potential overall pollution load to the sanitary sewer from washing operations for tools, vehicles, engines, and manufacturing equipment:

- Minimize water and detergent use in all washing operations.
- Use phosphate-free detergents when practical.
- Consider recycling the washwater by installing a closed-loop water recycling system.

- Use the least hazardous cleaning products available.
- For intermittent washing of vehicles, use a car wash that recycles washwater and discharges to the sanitary sewer.

3.2. Transfer of Liquid or Solid Materials

The transfer of liquid or solid materials, including the loading and unloading of such material, fueling of vehicles or equipment at mobile or designated locations, and vehicle and equipment repair and maintenance are activities that have a high risk for spills or leaks of toxic material. Both required and recommended BMPs can help prevent, minimize, and manage the effects of accidental spills or leaks. The specific BMPs that apply to the transfer of particular types of liquid and solid materials are presented in this section.

Remember to also implement ~~all required citywide~~ [BMPs 1 through BMP 8 for all real property](#) from [Section 2.1Chapter 2](#).

3.2.1. *BMP 189: Loading and Unloading of Liquid or Solid Material*

This BMP applies to businesses and public agencies engaged in the loading and unloading of liquid or solid materials or the transfer of non-containerized bulk materials. Sources of pollution include loading docks, vehicles, and equipment involved in material handling. These activities are typically conducted at shipping and receiving areas, outside storage areas, and fueling areas.

Description of Pollutants

Leaks and spills of fuels, oils, powders, organic compounds, nutrients, metals, food products, salts, acids, and alkalis during transfer are potential sources of stormwater contamination. Spills from breaks in hydraulic lines and leaking forklifts are common problems at loading docks. Many inlets/catch basins in Seattle discharge directly to local streams and waterways and therefore spilled or leaked products can adversely affect water quality and harm both people and aquatic organisms that come in contact with the contaminated water. These pollutants must not be discharged to the drainage system or directly into receiving waters.

Required BMP Elements

The following BMPs or equivalent measures are required in all loading and unloading areas:

- Implement ~~all citywide~~ [BMPs 1 through BMP 8 for all real property](#) (refer to [Section 2.1](#)~~Chapter 2~~).
- Sweep as often as necessary to prevent material contact with stormwater and to remove accumulated debris and other material that could otherwise be washed off by stormwater. Do not sweep this debris into drainage infrastructure.
- Place drip pans or other appropriate temporary containment devices in locations where leaks or spills may occur, such as hose connections, hose reels, and filler nozzles (Figure 8).
- Always use drip pans when making and breaking connections. Clean drip pans after each use to remove any residual material. Dispose of any residual material in accordance with the Seattle Solid Waste Collection Code (SMC, Chapter 21.36) and the state Dangerous Waste Regulations (WAC, Chapter 173-303).
- Inspect loading and unloading areas after each delivery for leaks and spills and clean up immediately.
- Check material handling equipment such as valves, hoses, pumps, flanges, and connections regularly for leaks, and repair as needed. Document and keep all inspection records. Store contaminated equipment inside or under cover to prevent residual material from coming into contact with stormwater.
- [Provide impervious containment with berms, dikes, etc., and/or cover the loading/unloading area to prevent run-on and runoff of contaminated stormwater. Maintain drainage areas in and around storage areas for solid materials with a minimum slope of 1.5 percent to prevent pooling and minimize leachate formation. Areas should be sloped to drain stormwater to the perimeter for collection or to internal "alleyways" where no stockpiled material is kept. Place curbs along the edge or slope the edge of the loading and unloading area such that stormwater can flow to an](#)

~~internal drainage system that leads to an approved treatment BMP. This will prevent contaminated stormwater from passing directly over paved surfaces and into the drainage system.~~

- ~~● Pave and slope loading and unloading areas to prevent the pooling of water. The use of catch basins and drain lines in the interior of the paved area should be minimized as they frequently become covered by material. Catch basins are preferred in designated “alleyways” that will not be covered by material, containers, or equipment.~~



Figure 8. Temporary Containment Device Placed Under a Hose Connection.

~~Consistent with the requirements of this volume of the Seattle Stormwater Manual and the Seattle Fire Code (SMC, Chapter 22.600) and to the extent practical, unload and load solids and liquids in a manufacturing building or under a roof, lean to, or other appropriate cover.~~

The following BMPs or equivalent measures are required in areas of transfer from tanker trucks and railcars to aboveground or underground storage tanks:

- To minimize the risk of accidental spillage, prepare and follow an “Operations Plan” that describes procedures for loading/unloading. Train employees on the plan.
- For rail facilities, install and maintain a drip pan system within the rails to collect spills and leaks from tank cars, hose connections, hose reels, and filler nozzles.

The following BMPs or equivalent measures are required in areas of loading and unloading from or to marine vessels:

- Facilities and procedures for the loading or unloading of petroleum products must comply with U.S. Coast Guard requirements; ~~refer to specifications in the (Stormwater Management Manual for Western Washington (SWMMWW), Volume IV, Appendix IV-D R.5 (Ecology 2014).~~
- For requirements related to the transfer of small quantities from tanks and containers:
- Refer to BMP [2825](#) for storage of portable containers of liquid or dangerous waste containers (*Section 3.4.33-4.4*) and BMP [1626](#) for storage of liquids in aboveground tanks (*Section 2.1.163-4.5*).

Recommended BMPs

Although not required, the following BMPs can provide additional pollution protection:

- Whenever possible, conduct the activity indoors or under cover to minimize exposure to stormwater.
- ~~Choose less toxic materials for use in facility operations.~~
- For the transfer of liquids in areas that cannot contain a catastrophic spill, install an automatic shutoff system in case of an unanticipated interruption in off-loading (e.g., a coupling break, hose rupture, or overfill).
- Install and maintain overhangs (Figure 9) or door skirts that enclose the trailer end to prevent contact with stormwater.



Figure 9. Loading Docks with an Overhang to Prevent Material Contact with Stormwater.

[Mobile Fueling of Vehicles and Heavy Equipment \(BMP 10-1210\)](#) (Section [2.1.1023-2.2](#)) is recommended in areas of transfer from tanker trucks to aboveground or underground storage tanks; [and it](#) includes:

- Pave the area on which the transfer takes place. If any transferred liquid, such as gasoline, is reactive with asphalt, pave the area with Portland cement concrete or equivalent.
- Construct a slope, berm, or dike to direct runoff from the transfer area to a dead-end sump, spill containment sump, [a](#)-spill control oil/water separator, or other spill control device. The minimum spill retention time should be 15 minutes for the flow rate of the dispensing mechanism with the highest through-put rate, or at the peak flow rate of the 6-month, 24-hour storm event ([or 91 percent of the total runoff volume for the simulation period if using continuous runoff modeling](#)) over the surface of the containment pad, whichever is greater. The volume of the spill containment sump should be a minimum of 50 gallons with an adequate grit sedimentation volume.

~~3.2.2. ***BMP 11: Maintenance and Repair of Vehicles and Equipment***~~

[\[This BMP was moved to Chapter 2 – tracked changes from the 2016 Stormwater Manual are shown in Chapter 2.\]](#)

3.3. Production and Application

Production and application activities are associated with a high risk for spills or leaks of toxic material. Required and recommended BMPs can help to prevent, minimize, and manage accidental spills or leaks so that there are minimal environmental impacts. The specific BMPs that apply to particular types of production and application activities are presented in this section.

Remember to also implement ~~all required citywide~~ BMPs 1 through BMP 8 for all real property from Section 2.1Chapter 2.

~~3.3.1. ***BMP 13: Concrete and Asphalt Mixing and Production***~~

[\[This BMP was moved to Chapter 2 – tracked changes from the 2016 Stormwater Manual are shown in Chapter 2.\]](#)

~~***BMP 14: Concrete Pouring, Concrete/Asphalt Cutting, and Asphalt Application***~~

[This BMP was moved to Chapter 2 – tracked changes from the 2016 Stormwater Manual are shown in Chapter 2.]

3.3.2.3.3.1. BMP 1915: Manufacturing and Post-Processing of Metal Products

This BMP applies to businesses and public agencies such as mills, foundries, and fabricators that manufacture or process metal products. A variety of activities such as machining, grinding, soldering, cutting, welding, quenching, etching, bending, coating, cooling, and rinsing may take place.

Description of Pollutants

Pollutants of concern include toxic organic compounds, metals, oils and greases, pH, suspended solids, and substances that increase COD. These pollutants must not be discharged to the drainage system or directly into receiving waters.

Required BMP Elements

Activities associated with metal manufacturing and processing may require an NPDES permit from Ecology. Refer to Ecology's website (<https://ecology.wa.gov/Water-Shorelines/Water-quality/Runoff-pollution/Stormwater>www.ecy.wa.gov/programs/wq/stormwater/index.html) or call Ecology at (360) 407-6000 to determine if the site activities trigger permit coverage.

The following BMPs or equivalent measures are required of all businesses and public agencies engaged in activities related to manufacturing and processing of metal products:

- Implement ~~all citywide~~ [BMPs 1 through BMP 8 for all real property](#) (refer to [Section 2.1](#)~~Chapter 2~~).
- Process wastewater (including contact cooling water, filter backwash, or cooling tower blowdown) from this activity and stormwater runoff from processing or production areas must be discharged to the sanitary sewer ~~or, a holding tank, or process treatment system~~. If a holding tank is used for the storage of wastewater, the contents must be pumped out before the tank is full and disposed of appropriately to the sanitary sewer or ~~process treatment system~~ [hauled off site](#). Obtain all necessary permits for discharge to the sanitary sewer.
- Cover the activity area to prevent rain from contacting the process and to reduce the amount of runoff that may require treatment.
- Make sure all outside materials that have the potential to leach or spill to the drainage system are covered, contained, or moved to an indoor location.
- Sweep the activity area at the end of each workday or more often as needed to collect and properly dispose of metal fragments and product residues. Do not allow metal fragments, residues, or dust to accumulate in areas exposed to stormwater.
- Educate employees about controlling their work with metal products to minimize stormwater pollution. Document and keep all training records on hand.

Recommended BMPs

Although not required, the following BMPs are recommended to further prevent and minimize the contamination of stormwater resulting from the manufacturing and processing of metal products:

- Limit the amount of water used in quenching and rinsing. Recycle used water where possible.
- Use a catch basin filter to capture stray metal particles. Maintain the filter regularly (weekly or as needed) to prevent plugging.

For information about water quality treatment BMPs related to concrete and asphalt mixing and production activities, refer to *Volume 3 – Project Stormwater Control*. For a current list of proprietary and emerging water quality treatment technologies, refer to Ecology’s website (<https://ecology.wa.gov/Regulations-Permits/Guidance-technical-assistance/Stormwater-permittee-guidance-resources/Emerging-stormwater-treatment-technologies>www.ecy.wa.gov/programs/wq/stormwater/newtech/index.html).

~~3.3.3.3.2.~~ ***BMP 2016: Processing and Storage of Treated Wood***

This BMP applies to businesses and public agencies that perform wood treatment including both anti-staining and preserving using pressure processes, dipping, or spraying. It also applies to businesses and public agencies ~~whothat store or~~ cut treated wood [outside](#).

Description of Pollutants

Pollutant sources include drips of condensate or preservative after pressurized treatment, product washwater (in the treatment or storage areas), spills and leaks from process equipment and preservative tanks, fugitive emissions from vapors in the process, blowouts and emergency pressure releases, and kick-back from lumber (leakage of preservative as it returns to normal pressure).

Potential pollutants typically include wood treating chemicals, substances that increase biological oxygen demand (BOD), suspended solids, oils and greases, benzene, toluene, ethylbenzene, phenol, chlorophenols, nitrophenols, metals such as chromium and zinc, and polycyclic aromatic hydrocarbons (PAHs). Potential pollutants depend on the chemical additive used. Wood preservatives and antistaining chemical additives include creosote, creosote/coal tar, pentachlorophenol, copper naphthenate, arsenic trioxide, and inorganic arsenicals. These pollutants must not be discharged to the drainage system or directly into receiving waters.

Required BMP Elements

Activities associated with processing treated wood may require an NPDES permit from Ecology. Refer to Ecology's website (<https://ecology.wa.gov/Water-Shorelines/Water-quality/Runoff-pollution/Stormwater> www.ecy.wa.gov/programs/wq/stormwater/index.html) or call Ecology at (360) 407-6000 to determine if the site activities trigger permit coverage.

The following BMPs or equivalent measures are required of all businesses and public agencies engaged in activities related to wood treatment ~~and storage~~:

- Implement ~~all citywide~~ [BMPs 1 through BMP 8 for all real property](#) (refer to [Section 2.1](#) ~~Chapter 2~~).

Production Areas:

- Cover and/or enclose the following and contain with impervious surfaces:
 - All wood treatment areas
 - All treated wood
 - All associated wastes
- Segregate clean stormwater from process water. Convey all process water to an approved treatment system and discharge to the sanitary sewer [or haul off site](#). Obtain all necessary permits for discharge to the sanitary sewer.
- Dedicate equipment that is used for treatment activities to prevent the tracking of treatment chemicals to other areas on site.

- For areas around dip tanks, spray booths, and retorts:
 - Eliminate non-process traffic on the drip pad.
 - Scrub down non-dedicated lift trucks on the drip pad.
 - Construct a slope and direct the drainage in a manner that allows treatment chemicals to flow back to the wood treatment process.
 - Seal any holes or cracks in the asphalt areas subject to contamination with wood treatment chemicals.

Storage Areas:

- Cover and/or enclose storage areas for treated wood and contain with impervious surfaces. [Alternatively, dry lumber stacks may be thoroughly wrapped in plastic to prevent contact with stormwater, elevated, and stored in uncovered areas.](#)
- Immediately remove and properly dispose of soils with visible surface contamination to prevent the spread of chemicals to groundwater or another receiving water from stormwater runoff.

For Treated Wood Products:

- Elevate treated wood products to prevent contact with stormwater run-on and runoff.
- Place treated wood products over the dip tank or on an inclined ramp for a minimum of 30 minutes to allow excess chemicals to drip back to the dip tank.
- ~~Place in a covered paved storage area for at least 24 hours before placement in outside storage. Use a longer storage period during cold weather unless the temporary storage building is heated. See storage requirements above for outdoor storage.~~ [Bulk storage of treated wood is permitted outside only when the units are protected from contact with stormwater by tarpaulins or wraps.](#)
- ~~Ensure that the wood is drip free and dry on the surface before it is moved.~~
- [When cutting treated wood, collect all dust and debris for proper disposal.](#)
- ~~If any wood is observed to be contributing chemicals to the environment in the treated wood storage area, relocate it on a concrete chemical containment structure until the surface is clean and the wood is drip free and dry on the surface.~~

3.3.4.3.3. BMP 2117: Commercial Composting

This BMP applies to commercial composting facilities that operate outside without cover. These facilities require large areas for the decomposition of waste and other feedstock.

Description of Pollutants

When stormwater is allowed to seep through active composting areas—including waste receiving and processing areas—it becomes leachate. Pollutants in leachate include nutrients, substances that increase biological oxygen demand (BOD), organic compounds, coliform bacteria, low (acidic) pH, color, and suspended solids. Runoff from areas at the facility that is not associated with active processing and curing, such as product storage areas, vehicle maintenance areas, and access roads, can also contain contaminants. These pollutants must not be discharged to the drainage system or directly into receiving waters.

Required BMP Elements

Activities associated with commercial composting may require an NPDES permit from Ecology [as well as other permits](#). Refer to Ecology's website (<https://ecology.wa.gov/Water-Shorelines/Water-quality/Runoff-pollution/Stormwater>) www.ecy.wa.gov/programs/wq/stormwater/index.html or call Ecology at (360) 407-6000 to determine if the site activities trigger permit coverage. For state regulations related to composting facilities, refer to WAC, Section 173-350-220.

The following BMPs or equivalent measures are required of all businesses and public agencies engaged in commercial composting activities:

- Implement ~~all citywide~~ [BMPs 1 through BMP 8 for all real property](#) (refer to [Section 2.1 Chapter 2](#)).
- ~~Ensure that compost feedstock does not contain dangerous wastes regulated under WAC, Chapter 173-303, or hazardous products of a similar nature.~~
- ~~Train employees to screen incoming wastes for undesirable materials. Document and keep all training records.~~
- [Screen incoming wastes for dangerous materials and solid wastes. These materials will not be accepted for composting and must be properly disposed of.](#)
- Clean up and sweep debris from yard areas daily and more often as needed.
- Store finished compost [on an impervious surface and](#) in a manner to prevent contamination of stormwater.
- [Convey all leachate to the sanitary sewer, a holding tank, or a permitted onsite treatment system that is designed to treat the leachate and remove suspended solids. If a holding tank is used for the storage of leachate, the contents must be pumped out before the tank is full and disposed of appropriately to a sanitary sewer or wastewater treatment system.](#)

- For new and redeveloped facilities, prevent and minimize stormwater contamination by storing finished compost on a concrete pad that is:
 - Curbed to separate leachate from uncontaminated stormwater
 - Sloped sufficiently to direct leachate to the collection device
 - Designed with one or more sumps or catch basins capable of collecting all leachate generated by the design storm and conveying it to the leachate holding structure
- Ponds used to collect, store, or treat leachate and other contaminated waters associated with the composting process must be lined to prevent groundwater contamination. Apply All Known Available and Reasonable Methods of Prevention, Control, and Treatment (AKART) technologies to all pond liners, regardless of the construction materials.

Recommended BMPs

Although not required, the following BMPs are recommended to further prevent and minimize the contamination of stormwater resulting from commercial composting activities:

- Locate stored residues in areas designed to collect leachate and limit storage times to prevent degradation and generation of leachate.

~~3.3.5.~~ **3.3.4. BMP 22-18: Landscaping and Vegetation Management**

This BMP applies to businesses and public agencies that perform landscaping, including grading, storage of landscape materials, soil transfer, vegetation removal, pesticide and fertilizer applications, and watering. Landscaping and vegetation management can include control of objectionable weeds, insects, mold, bacteria, and other pests by means of chemical pesticides and is conducted commercially at commercial, industrial, and residential sites. Examples of landscaping and lawn and vegetation management include weed control on golf courses, access roads, and utility corridors; treatment or removal of moss from rooftops, sidewalks, or driveways; killing of nuisance rodents; application of fungicides on patio decks; and residential lawn and plant care.

Description of Pollutants

Stormwater contaminants from landscaping and vegetation management activities include toxic organic compounds, metals, oils, suspended solids, pH, coliform bacteria, fertilizers, pesticides, and detergents.

Pesticides such as pentachlorophenol, carbamates, and organometallics can be released to the environment as a result of leaching and dripping from treated plants, container leaks, product misuse, and outside storage of pesticide-contaminated materials and equipment. Inappropriate management of vegetation and improper application of pesticides or fertilizers can result in stormwater contamination. These pollutants must not be discharged to the drainage system or directly into receiving waters, except as permitted by Ecology.

The Washington State Department of Agriculture regulates pesticide use and application.

Required BMP Elements

The following BMPs or equivalent measures are required of all businesses and public agencies engaged in landscaping and vegetation management activities:

- Implement ~~all citywide~~ [BMPs 1 through BMP 8 for all real property](#) (refer to [Section 2.1](#) ~~Chapter 2~~).

Landscaping:

- Do not dispose ~~of or store of~~ collected vegetation in drainage systems, waterways, receiving waters, or ~~greenbelt areas~~ [public spaces](#). Take care to avoid contamination or site disturbance.
- Use mulch or other erosion control measures when soils or erodible materials are exposed for more than 1 week during the dry season (May 1 to September 30) or 2 days during the rainy season (October 1 to April 30).
- [Comply with Appendix I of this manual and S435 – BMPs for Pesticides and an Integrated Pest Management Program in Volume IV of the SWMMWW \(Ecology 2019\) \(referenced in BMP 49 and BMP 50\) for more information.](#)
- [Implement the landscaping principles in Volume 1, Section 7.8, when planning, constructing, and maintaining landscaped areas.](#)

- Comply with all landscape management plans that apply to the site (refer to Appendix I of this manual).

Pesticides:

- Develop and implement an Integrated Pest Management (IPM) plan (refer to Appendix I). If pesticides or herbicides are used, they must be carefully applied in accordance with label instructions and the Federal Insecticide, Rodenticide and Fungicide Act (FIFRA) and applicable state laws.
 - Choose the least toxic pesticide that is capable of reducing the infestation to acceptable levels.
 - Conduct any pest control during the life stage when the pest is most vulnerable. For example, if it is necessary to use a *Bacillus thuringiensis* application to control tent caterpillars, it must be applied before the caterpillars form their cocoons or it will be ineffective. The pest control method should be site specific rather than using generic methods.
-
- When necessary to use, apply pesticides according to the directions on the label and use the following BMPs:
 - Conduct spray applications according to specific label directions and the applicable local and state regulations.
 - Do not apply pesticides if it is raining or immediately before expected rain (unless the label directs such timing).
 - Ensure that the pesticide application equipment is capable of immediate shutoff in the event of an emergency.
 - Do not apply pesticides within 100 feet of receiving waters, including wetlands, ponds, streams, sloughs, or any ditch or channel conveyance that leads to receiving water, except when approved by Ecology or SPU. All critical areas including streams and wetlands must be flagged prior to spraying. Take care to avoid contamination or site disturbance during applications.
 - Never apply pesticides in quantities that exceed the manufacturer's instructions.
 - Mix pesticides and clean the application equipment under cover in an area where accidental spills will not enter groundwater or other receiving waters and will not contaminate the soil.
 - For roof moss control, ensure that runoff does not enter downspouts or otherwise contaminate stormwater.

The Environmentally Critical Area (ECA) Ordinance (SMC, Chapter 25.09) also restricts certain described pesticide use within buffer zones of certain critical areas.

- Storage:
 - Store pesticides in enclosed or covered impervious containment areas.
 - Do not hose down the paved areas to an inlet/catch basin or ditch.
 - Keep pesticide contaminated waste materials in designated covered and contained areas, and dispose of properly.

- ~~Reuse rinsate generated from equipment cleaning and/or triple rinse pesticide containers and reuse as product or recycle into product.~~

Vegetation Management:

- Fertilizer:
 - Apply all fertilizers using properly trained personnel. Document and keep all training records.
 - For commercial and industrial facilities, do not apply fertilizers to grass swales, filter strips, or buffer areas that drain to receiving waters.
 - [Refer to S443 – BMPs for Fertilizer Application in Volume IV of the SWMMWW \(Ecology 2019\) for additional information \(referenced in BMP 55\).](#)

Recommended BMPs

~~For more details on landscaping and vegetation management, refer to the Stormwater Management Manual for Western Washington (SWMMWW), Volume IV, Source Control, BMPs for Landscaping and Lawn/Vegetation Management (Ecology 2014).~~

Although not required, the following BMPs are recommended to further prevent and minimize the contamination of stormwater resulting from landscaping and lawn and vegetation management activities:

- If adjacent to a building or constructed over hazardous material storage areas, other regulations, including the Seattle Fire Code, may apply.
- Install engineered soil and landscape systems to improve the infiltration and regulation of stormwater in landscaped areas.
- Mulch and mow whenever practical.
- Dispose of grass clippings, leaves, sticks, and other collected vegetation by composting, where feasible.
- Till fertilizers into the soil where practical rather than dumping or broadcasting them onto the surface. Determine the proper fertilizer application for the types of soil and vegetation encountered.
- Till a topsoil mix or composted organic material into the soil to create a well-mixed transition layer that encourages deeper root systems and greater drought-tolerance.
- Use manual and/or mechanical methods of vegetation removal rather than applying herbicides, where practical.

Pesticides:

- ~~Consider alternatives to the use of pesticides, such as covering or harvesting weeds, substituting other species, and manual weed control and moss removal.~~
- ~~Consider the use of soil amendments, such as compost, that are known to control some common diseases in plants, such as root rot (caused by the pathogen *Pythium* spp.), ashy stem blight, and parasitic nematodes. The following are possible mechanisms for disease control by compost addition (U.S. EPA 1997):~~
 - ~~Successful competition for nutrients by antibiotic production~~

- ~~Successful predation against pathogens by beneficial microorganisms~~
- ~~Activation of disease resistant genes in plants by composts~~

An amended soil and landscape system can preserve both the plant system and the soil system more effectively. This type of approach can provide a soil and landscape system with adequate depth, permeability, and organic matter to sustain itself and continue working to effectively infiltrate stormwater and provide a sustainable nutrient cycle.

Vegetation Management:

- Material:
 - Use topsoil layer that is at least 8 inches thick and consists of at least 8 percent organic matter to provide a sufficient growing medium for the vegetation.
 - Select the appropriate turfgrass mixture for the applicable climate and soil type.
- Fertilizer:
 - Use slow-release fertilizer and organic materials for the best availability for turf grass.
 - Time the fertilizer application to periods of maximum plant uptake. Fertilizers should be applied in amounts appropriate for the target vegetation and at the time of year that minimizes loss to surface water and groundwater.
 - Do not fertilize during a drought or when the soil is dry.
 - [Refer to the S443 – BMPs for Fertilizer Application in the SWMMWW \(Ecology 2019\) for additional information \(referenced in BMP 55\).](#)

~~3.3.6.~~ **3.3.5. BMP 2319: Painting, Finishing, and Coating Activities**

This BMP applies to businesses and public agencies that perform outdoor surface preparation and application of paints, finishes, and coatings to vehicles, boats, buildings, and equipment.

Description of Pollutants

Potential pollutants include organic compounds, oils and greases, metals, and suspended solids. These pollutants must not be discharged to the drainage system or directly into receiving waters.

Required BMP Elements

Activities associated with boatyard and shipyard operations may require an NPDES permit from Ecology. Refer to Ecology's website (<https://ecology.wa.gov/Water-Shorelines/Water-quality/Runoff-pollution/Stormwater>www.ecy.wa.gov/programs/wq/stormwater/index.html) or call Ecology at (360) 407-6000 to determine if the site activities trigger permit coverage.

The following BMPs or equivalent measures are required of all businesses and public agencies engaged in activities related to the painting, finishing, and coating of vehicles, boats, buildings, and equipment outside.

- Implement ~~all citywide~~ [BMPs 1 through BMP 8 for all real property](#) (refer to [Section 2.1](#) ~~Chapter 2~~).

Preparation and Application:

- Train employees in the application and cleanup of paints, finishes, and coatings to reduce misuse and overspray. Document and keep all training records.
- Use ground cloths or drop cloths underneath outdoor painting, scraping, sandblasting work, and properly clean and temporarily store collected debris after each use.
- Use a catch basin cover, filter sock, or similarly effective runoff control device if dust, sediment or other pollutants may escape the work area. If catch basin filter socks are used onsite, maintain the filter regularly to prevent plugging. Stormwater contaminated with pollutants must not enter the drainage system.

Catch basin filter socks only remove solids and do not provide treatment for other pollutants associated with painting, finishing, and coating activities.

- Do not conduct spraying, blasting, or sanding activities over open water or where wind may blow paint into water. If windy conditions are present, use a curtain to contain the activity.
- While using a spray gun or conducting sand blasting, enclose and/or contain all work in compliance with applicable air pollution control requirements and those of the Occupational Safety and Health Administration (OSHA), the Washington Industrial Safety and Health Act, and the Puget Sound Clean Air Agency.

Cleanup:

- Wipe up spills with rags and other absorbent materials immediately. Do not hose down the area.
- On marine dock areas, sweep to collect debris. Do not hose down debris.
- Use a ground cloth, pail, drum, drip pan, tarpaulin, or other protective device for activities such as paint mixing and tool cleaning outside or where spills can contaminate stormwater. Whenever possible, conduct these activities inside or in an enclosed area.
- Clean paintbrushes and tools covered with water-based paints into drains connected to the sanitary sewer. Verify the discharge point before discharging.
- Collect solvents used to clean brushes and tools covered with non-water-based paints, finishes, or other materials. Safely and properly recycle or dispose of used solvents (e.g., paint thinner, turpentine, and xylol).

Material Storage and Disposal:

- Dispose of all waste properly and prevent all uncontrolled releases to the air, ground, or water.
- Store all paints, finishes, or solvents inside a building or in covered secondary containment.
- All containers must have tight-fitting lids [able to retain the contents in the event of tipping](#).

Recommended BMPs

Although not required, the following BMPs are recommended to further prevent and minimize the contamination of stormwater resulting from activities related to the painting, finishing, and coating of vehicles, boats, buildings, and equipment:

- Recycle paints, paint thinner, solvents, washwater from pressure washers, and any other recyclable materials.
- Use efficient spray equipment such as electrostatic, air-atomized, high-volume/low-pressure, or gravity-feed spray equipment.
- Purchase recycled paints, paint thinner, solvents, and other products where feasible.
- Dispose of unused paint promptly.

3.3.7.3.3.6. BMP 2420: Commercial Printing Operations

This BMP applies to businesses and public agencies that perform commercial printing. Materials used in the printing process include inorganic and organic acids, resins, solvents, polyester film, developers, alcohol, vinyl lacquer, dyes, acetates, and polymers.

Description of Pollutants

Waste products from commercial printing processes may include waste inks and ink sludge, resins, photographic chemicals, solvents, acid and alkaline solutions, chlorides, chromium, zinc, lead, formaldehyde, silver, plasticizers, paper, dust, and used lubricating oils. These pollutants must not be discharged to the drainage system or directly into receiving waters.

Printing operations are conducted indoors; therefore, the likely points of potential contact with stormwater are outside storage areas and the external loading bays where chemicals are offloaded.

Required BMP Elements

The following BMPs or equivalent measures are required of all businesses and public agencies engaged in commercial printing activities:

- Implement ~~all citywide~~ [BMPs 1 through BMP 8 for all real property](#) (refer to [Section 2.1](#)~~Chapter 2~~).
- Sweep outdoor areas as necessary to prevent accumulation of dust and debris.
- Discharge process wastewater to the sanitary sewer if approved by SPU and/or King County, or to an approved process wastewater treatment system.
- Determine whether any generated wastes are dangerous wastes and accumulate and dispose of them accordingly.
- Store materials inside a building or in covered secondary containment.

~~3.3.8.~~3.3.7. BMP 2521: Manufacturing Activities

This BMP applies to businesses and public agencies that perform any type of outdoor processing, fabrication, mixing, milling, or refining. This also includes areas where historical contamination may currently be contaminating stormwater.

Description of Pollutants

Pollutant sources from outside manufacturing operations include outside process areas, air pollution control equipment, and areas of historical manufacturing activity. Pollutants can include suspended solids, pH, metals, oils and greases, a variety of organic compounds, and substances that increase chemical oxygen demand (COD). These pollutants must not be discharged to the drainage system or directly into receiving waters.

Required BMP Elements

Outdoor activities associated with industrial manufacturing may require an NPDES permit from Ecology. Refer to Ecology's website (<https://ecology.wa.gov/Water-Shorelines/Water-quality/Runoff-pollution/Stormwater>www.ecy.wa.gov/programs/wq/stormwater/index.html) or call Ecology at (360) 407-6000 to determine if the site activities trigger permit coverage.

The following BMPs or equivalent measures are required of all businesses and public agencies engaged in outdoor manufacturing activities:

- Implement ~~all citywide~~ [BMPs 1 through BMP 8 for all real property](#) (refer to [Section 2.1](#) ~~Chapter 2~~).
- Move all or parts of the manufacturing activity into a building or cover (Figure 10), contain the activity, and connect floor drains to the sanitary sewer. Obtain all necessary permits for installing, altering, or repairing side sewers. Restrictions on certain types of discharges may require pretreatment of discharges before they enter the sanitary sewer. Construct a berm or a sloped floor as needed to prevent drainage of pollutants to outside areas and to prevent run-on of uncontaminated stormwater.
- Make sure all outside materials that have the potential to leach or spill to the drainage system are covered, contained, or moved to an indoor location. The cover must not contribute pollutants to the drainage system.
- Sweep paved areas daily or more often as needed to prevent contamination of stormwater.
- ~~Consider modifying the activity to eliminate or minimize the contamination of stormwater.~~
- Isolate and segregate pollutants where feasible. Convey the segregated pollutants to a sanitary sewer, process treatment, or dead-end sump, depending on the available methods and applicable permit requirements.
- If operational BMPs are not sufficient to prevent stormwater contamination, structural controls must be implemented, including treatment or structural containment.

[Recommended BMPs](#)

[Although not required, the following BMPs are recommended to further prevent and minimize the contamination of stormwater resulting from manufacturing activities:](#)

- [Consider modifying the activity to eliminate or minimize the contamination of stormwater.](#)



Figure 10. Structure Used To Cover Manufacturing Activities.

3.4. Storage and Stockpiling

Activities related to the storage and stockpiling of liquid or solid materials are potentially associated with a high risk for spillage, leakage, erosion, or leaching of pollutants. Both required and recommended BMPs can help to prevent, minimize, and manage the effects of accidental spills and leaks. The specific BMPs that apply to various types of storage and stockpiling activities are presented below.

Remember to also implement ~~all required citywide~~ [BMPs 1 through BMP 8 for all real property](#) from [Section 2.1](#) ~~Chapter 2~~.

3.4.1. *BMP ~~2622~~: Storage ~~or Transfer~~ of Leachable or Erodible Materials*

This BMP applies to businesses and public agencies on whose premises there will be storage ~~and transfer~~ of leachable and erodible materials, including, but not limited to: gravel, sand, salts, topsoil, compost, logs, sawdust, wood chips, lumber and other building materials, concrete, and non-coated galvanized metal or other leachable metal.

Description of Pollutants

If stormwater comes in contact with stockpiled materials, pollutants may be leached or erosion of the stored materials may occur. [Though these materials are typically destined to be used outside, storage of large quantities of these materials awaiting sale or use can contribute high levels of localized pollutant loading.](#) Potential pollutants include suspended solids, substances that increase biological oxygen demand (BOD), organic compounds, dissolved salts (e.g., sodium chloride, calcium chloride, and magnesium chloride), metals, and oils that may be attached to metal parts. These pollutants must not be discharged to the drainage system or directly into receiving waters. Even low levels of metals such as copper and zinc can have detrimental effects on aquatic life.

Required BMP Elements

The following BMPs or equivalent measures are required of all businesses and public agencies engaged in the storage ~~or transfer~~ of leachable or erodible materials:

- Implement ~~all citywide~~ [BMPs 1 through BMP 8 for all real property](#) (refer to [Section 2.1 Chapter 2](#)).
- Store the material inside or cover and contain the material. The cover must fully prevent wind and weather contact with the polluting material. The cover must not contribute pollutants to the drainage system.
- Do not hose down the contained stockpile area to an inlet/catch basin, ditch, or to receiving waters.
- Sweep paved storage areas daily or more often as necessary to collect and dispose of loose solid materials.
- For stockpiles ~~larger than 5 cubic yards~~, implement the following:
 - Store in a covered, paved area, preferably surrounded by a berm, as shown in Figure 11. The cover must fully prevent wind and weather contact with the polluting material. The cover must not contribute pollutants to the drainage system.
 - Place temporary plastic sheeting (polyethylene, polypropylene, Hypalon, or equivalent material) over the material as illustrated in Figure 12. Anchor sheeting to prevent contact with rainfall.
 - [For new or modified areas, pPave the area](#) and install a drainage system:
 - Place curbs or berms along the perimeter of the area to prevent the run-on of uncontaminated stormwater and to collect and convey runoff to a treatment system.

- Slope the paved area in a manner that minimizes the contact between stormwater (e.g., pooling) and leachable materials.



Figure 11. Covered and Secured Storage Area for Bulk Solids.



Figure 12. Covered Storage Area for Erodible Material (gravel).

- For large stockpiles that cannot be covered:
 - Install containment devices such as a berm or a low wall around the perimeter of the site and at any catch basins as needed to prevent erosion of the stockpiled material, and to prevent discharge of leachate from the stockpiled material off site or to an inlet/catch basin.
 - Ensure that contaminated stormwater is not discharged directly to [the drainage system catch basins](#) without being conveyed through a treatment BMP. [Volume 3 – Project Stormwater Control presents approved methods, requirements, criteria, details, and general guidance for analysis and design of on-site stormwater management, flow control, and water quality treatment pursuant to SMC, Chapter 22.800 through 22.808 \(Stormwater Code\).](#)
 - Inspect and maintain catch basins on a regular basis (weekly or more often as needed). ~~Use catch basin filter socks to catch solids.~~ Stormwater contaminated with pollutants must not enter the drainage system.
- ~~Convey stormwater contaminated with solids from the stockpile area to a wet pond, wet vault, settling basin, media filter, catch basin filter sock, or other appropriate settling system. Maintain all settling systems regularly (weekly or as needed) to prevent plugging.~~
- [Maintain drainage areas in and around storage areas for solid materials with a minimum slope of 1.5 percent to prevent pooling and minimize leachate formation. Slope storage areas to drain stormwater to a collection area at the perimeter of the storage area or to internal drainage “alleyways” between storage areas, where material is not stockpiled.](#)

- Make cleanup materials, such as brooms, dustpans, and vacuum sweepers, accessible for use near the storage area.

Recommended BMPs

The following BMPs are recommended to further prevent and minimize the contamination of stormwater resulting from activities related to the storage or transfer of leachable and erodible materials:

- ~~Maintain drainage areas in and around storage areas of solid materials with a minimum slope of 2 percent to prevent pooling and minimize leachate formation. Slope storage areas to drain stormwater to a collection area at the perimeter of the storage area, or to internal drainage “alleyways” between storage areas, where material is not stockpiled.~~
- If and when feasible, collect and recycle materials and leachate to the stockpile.
- ~~Stock cleanup materials, such as brooms, dustpans, and vacuum sweepers, near the storage area.~~
- Keep the minimum amount of stockpiled materials on site. Smaller piles minimize the loss of materials due to wind and rain and will make the piles more manageable to cover.
- ~~Use waterproof liners to prevent leaks from the solid waste container.~~
- ~~Whenever possible, store solid wastes inside.~~

3.4.2. *BMP ~~27-23~~: Temporary Storage or Processing of Fruits, Vegetables, or Grains*

This BMP applies to businesses and public agencies that temporarily store fruits, vegetables, and grains outdoors before processing or sale, or that crush, cut, or shred for wines, beer, frozen juices, or other food and beverage products.

Description of Pollutants

Activities involving the storage or processing of fruits, vegetables, and grains can potentially result in the delivery of pollutants to stormwater. Potential pollutants of concern from all fruit and vegetable storage and processing activities include nutrients, suspended solids, substances that increase biological oxygen demand (BOD), and color. These pollutants must not be discharged to the drainage system or directly into receiving waters.

Required BMP Elements

[Outdoor activities associated with food processing \(examples include brewing activities, grape crushing at wineries, and fresh fruit packing\) may require an NPDES permit from Ecology. Refer to Ecology's website \(<https://ecology.wa.gov/Water-Shorelines/Water-quality/Runoff-pollution/Stormwater>\) or call Ecology at \(360\) 407-6000 to determine if the site activities trigger permit coverage.](#)

The following BMPs or equivalent measures are required of all businesses and public agencies engaged in the temporary storage or processing of fruits, vegetables, and grains:

- Implement ~~all citywide~~ [BMPs 1 through BMP 8 for all real property](#) (refer to [Section 2.1](#) ~~Chapter 2~~).
- Do not allow water used to clean produce to enter the drainage system.
- Sweep paved storage areas daily or more often as needed. Inspect storage areas often and maintain good housekeeping.
- Make sure all outside materials that have the potential to leach or spill to the drainage system are covered, contained, or moved to an indoor location.
- Enclose the processing area in a building or shed, or cover the area with provisions for stormwater run-on prevention. [If less than 200 square feet, a](#) alternatively, pave and slope the area to drain to the sanitary sewer, [a](#) holding tank, or [a](#) process treatment system collection drain. ~~Provide-Prevent~~ stormwater run-on [from entering](#) ~~protection for~~ the processing area. If a holding tank is used for the storage of wastewater, pump out the contents before the tank is full ~~and dispose of wastewater to a sanitary sewer or approved wastewater treatment system~~ and [dispose of it properly](#).
- [Keep cleanup materials, such as brooms and dustpans, near the storage area.](#)

~~3.4.3. BMP 24: Recycling, Wrecking Yard, and Scrap Yard Operations~~

~~[This BMP was moved to Chapter 2 – tracked changes from the 2016 Stormwater Manual are shown in Chapter 2.]~~

3.4.4.3.4.3. BMP 2825: Portable Container Storage

The BMPs specified below apply to businesses and public agencies that keep containers [outside](#) on [their](#) premises that may include, but are not limited to, used automotive fluids, liquid feedstock, cleaning compounds, chemicals, dangerous wastes (liquid or solid), and contaminated stormwater. For outside storage of [used](#) cooking [grease-oil](#) containers, [see-refer to](#) BMP 4.

Description of Pollutants

Leaks and spills during handling and storage of portable containers are the primary sources of pollutants. Potential pollutant constituents are oils and greases, low (acid) or high (alkaline) pH, surfactants, substances that increase biological oxygen demand (BOD), substances that increase chemical oxygen demand (COD), and toxic organic compounds.

Required BMP Elements

The following required BMPs apply to all portable containers:

- Implement ~~all citywide~~ [BMPs 1 through BMP 8 for all real property](#) (refer to [Section 2.1Chapter 2](#)).
- ~~Wherever possible, store containers on a paved surface under a roof or other appropriate cover or in a building.~~
- Store materials in a leak-proof container with a tight-fitting lid [able to contain the material in the event of tipping](#).
- Label all containers to identify their contents. Position containers so [that labels/markings](#) are clearly visible. ~~If the material is hazardous waste it should have a hazardous waste label.~~
- ~~Ensure that spill kits are located near container storage areas.~~
- Place drip pans beneath all taps on mounted containers and at all potential drip and spill locations during the filling and [unloading-draining](#) of containers.
- Inspect container storage areas regularly for corrosion, structural failure, spills, leaks, [and](#) overfills, ~~and failure of piping systems~~. Check containers daily for leaks and spills. Replace containers and replace and tighten bungs in drums as needed.
- Secure [drums-containers](#) in a manner that prevents accidental spillage, pilferage, or any unauthorized use (Figure 13 and Figure 14).
- ~~Place containers mounted for direct removal of a liquid chemical inside a containment area as described above. Use a drip pan during liquid transfer.~~
- ~~For containers (such as drums) stored in the right-of-way, label with owner information and contents.~~

Recommended BMP Elements

- [Wherever possible, store containers on a paved surface under a roof or other appropriate cover or in a building.](#)



Figure 13. Covered and Secured Storage Area for Containers.



Figure 14. Containers Surrounded by a Berm in an Enclosed Area.

The following BMPs or equivalent measures are required for activities related to [outside storage of containers of hazardous or dangerous material](#) ~~or wastes and liquids except potable water or waste containers located outside~~:

- Store containers in a designated area. Provide covered secondary containment that is capable of holding a volume of either 10 percent of the total volume of the enclosed containers or 110 percent of the volume of the largest container, whichever is greater. Provide a portable secondary containment unit or cover and pave the storage area with an impervious surface and install a berm or dike to surround the area. Slope the area to drain into a dead-end sump for the collection of leaks and small spills.
- Store containers that do not contain free liquids in a designated sloped area with the containers elevated or otherwise protected from stormwater run-on.
- Elevate metal drums to prevent corrosion and leakage.
- Ensure that the storage of reactive, ignitable, or flammable liquids complies with the Seattle Fire Code and Washington State Fire Code.

Recommended BMPs

~~The following BMPs are recommended to further prevent and reduce the contamination of stormwater resulting from the storage of all liquid, containers:~~

- ~~● Provide secondary containment.~~
- ~~● Minimize inventory and accumulation to prevent excess storage of materials.~~

~~3.4.5. BMP 26: Storage of Liquids in Above-ground Tanks~~

[This BMP was moved to Chapter 2 through tracked changes from the 2016 Stormwater Manual are shown in Chapter 2.]

~~3.4.6. BMP 27: Lot Maintenance and Storage~~

This BMP applies to businesses and public agencies that own or operate public and commercial parking lots and sidewalks, such as those associated with retail stores, apartment buildings, fleet vehicles (including car rental lots and car dealerships), and equipment sale and rental facilities. It also includes properties where vehicles or equipment are stored outside.

Description of Pollutants

Potential pollutants produced by the parking and storage of vehicles and equipment include petroleum hydrocarbons and other organic compounds, oils and greases, metals, and suspended solids.

Required BMP Elements

The following BMPs or equivalent measures are required for activities related to the parking and storage of vehicles and equipment:

- ~~Implement all citywide BMPs (refer to Chapter 2).~~
- ~~Sweep or vacuum parking lots, storage areas, sidewalks, and driveways regularly to collect dirt, waste, and debris and dispose as solid waste.~~
- ~~When washing a parking lot, follow guidelines for washing found in BMP 8.~~
- ~~When storing materials other than vehicles, refer to applicable BMPs in this volume.~~
- ~~Inspect the lot routinely for leaks and spills. Employ spill cleanup procedures (refer to BMP 5) when necessary. Pick up absorbents and properly dispose of them after use.~~
- ~~An oil removal system such as an API oil/water separator, coalescing plate oil/water separator, catch basin filter sock, or equivalent BMP that is approved by SPU is required for parking lots that meet the threshold for vehicle traffic intensity of a high-use site. Refer to Volume 3 – Project Stormwater Control for information on traffic intensity thresholds. If a catch basin filter sock is used, maintain the filter regularly to prevent plugging.~~

3.5. Dust, Soil Erosion, and Sediment Control

Construction, manufacturing, and industrial activities have the potential to generate significant amounts of dust, soil, and sediment, which can pollute both air and stormwater. Control measures for dust, soil, and sediment are necessary to prevent pollution, but BMPs that are not properly implemented can be harmful to stormwater and the environment.

The required and recommended BMPs for these activities are presented below. First, prevent the production of dust, soil, and sediment. Then, implement BMPs to minimize their production. Finally, manage dust, soil, and sediment so that contaminated stormwater is not conveyed to the drainage system or receiving waters.

Remember to also implement ~~all required citywide~~ [BMPs 1 through BMP 8 for all real property](#) from [Section 2.1](#) ~~Chapter 2~~.

3.5.1. *BMP ~~2928~~: Dust Control in Disturbed Land Areas and on Unpaved Roadways and Parking Lots*

This BMP applies to businesses and public agencies that pursue dust control measures in disturbed land areas or on unpaved roadways and parking lots. All land-disturbing activity must comply with the erosion and sediment controls described in the Stormwater Code (SMC, [Chapters 22.800 through 22.808](#)).

Description of Pollutants

Dust can result in air and water pollution, particularly at demolition sites, in disturbed land areas, and on unpaved roadways and parking lots. Chemicals applied to dust-prone areas to minimize dust production also have the potential to pollute stormwater and receiving waters if they are not properly selected or applied.

Required BMP Elements

The following BMPs or equivalent measures are required of all businesses and public agencies engaged in activities that generate dust:

- Implement ~~all citywide~~ [BMPs 1 through BMP 8 for all real property](#) (refer to [Section 2.1Chapter 2](#)).
- Protect inlets/catch basins during application of dust suppressants. [Prevent liquid dust suppressants from flowing into the drainage system during application.](#)
- Sprinkle or wet down soil or dust with water as long as it does not result in a discharge to inlets/catch basins or receiving waters.
- Only use local and/or state government approved dust suppressant chemicals, such as those listed in Publication [No. 96-433, Methods for Dust Control Techniques for Dust Prevention and Suppression](#) (Ecology [2016a2003](#)).
- Avoid excessive and repeated application of dust suppression chemicals. Time the application of dust suppressants to avoid or minimize their wash off by rainfall or human activity (such as irrigation).
- Street gutters, sidewalks, driveways, and other paved surfaces in the immediate area of the activity must be swept regularly to collect and properly dispose of [dust, dirt, loose debris,](#) and garbage.
- Install catch basin filter socks on site and in surrounding catch basins to collect sediment and debris. Maintain the filters regularly to prevent plugging.

BMPs required for [construction](#) dust control, such as dust suppression by water spray, are provided in *Volume 2 – Construction Stormwater Control*.

3.5.2. *BMP 3029: Dust Control at Manufacturing Sites*

This BMP applies to all businesses and public agencies, but particularly industrial and manufacturing facilities that have the potential to generate dust, including gravel, crushed rock, cement, fly ash, and other airborne pollutants.

Description of Pollutants

Industrial material handling activities can generate a considerable amount of dust, which is typically removed by means of exhaust systems. The exhaust systems can generate air emissions and can contaminate stormwater. Dust can be generated by mixing cement and concrete products and handling powdered materials. Particulate materials that can cause air pollution are sawdust, coal, boiler fly ash, and dust from grain, coal, gravel, crushed rock, and cement. Air emissions can contaminate stormwater if not properly managed and controlled.

Required BMP Elements

The following BMPs or equivalent measures are required of all businesses and public agencies engaged in activities that can generate dust:

- Implement ~~all citywide~~ [BMPs 1 through BMP 8 for all real property](#) (refer to [Section 2.1 Chapter 2](#)).
- Clean accumulated dust and residue from powdered material handling equipment and vehicles as needed.
- Maintain onsite controls so that no vehicle track-out occurs.
- Regularly sweep areas of accumulated dust that can contaminate stormwater. Sweeping should be conducted with vacuum-filter equipment to minimize dust generation and ensure optimal dust removal.
- Maintain dust collection devices on a regular basis.
- Where feasible, periodically wash surfaces, such as roofs and yards, to prevent buildup. Discharge washwater to the sanitary sewer, [if authorized](#), or recover for proper off-site [treatment or disposal](#).
- If operational BMPs are not sufficient to prevent stormwater contamination, structural controls must be implemented, including treatment or structural containment.

Facility operations that create or have the potential to create air pollution are regulated by the Puget Sound Clean Air Agency. For more information on necessary permits, contact the Puget Sound Clean Air Agency at (800) 552-3565.

3.5.3. *BMP ~~3130~~: Soil Erosion and Sediment Control at Industrial Sites/Facilities*

This BMP applies to business and public agency industrial facilities that operate in ~~or near~~ areas with exposed or disturbed soils, areas with steep grades, or as deemed necessary to prevent sediment transport. For information on construction related soil erosion and sediment control, refer to *Volume 2 – Construction Stormwater Control*.

Description of Pollutants

Industrial activities in areas with exposed or disturbed soils or areas with steep grades can be sources of sediment that can contaminate stormwater runoff. Pollutants include suspended solids, oils and greases, metals, and other industrial contaminants ~~leaching~~ from onsite activities.

Required BMP Elements

The following BMPs or equivalent measures are required of all businesses and public agencies to deal with soil erosion and sediment control:

- Implement ~~all citywide~~ BMPs 1 through BMP 8 for all real property (refer to Section 2.1~~Chapter 2~~).
- Limit the exposure of erodible soil.
- Stabilize or cover erodible soil to prevent erosion.
- Stabilize entrances/exits to prevent track-out.
- Install one or more of the following cover practices:
 - Vegetative cover, such as grass, trees, or shrubs, in erodible soil areas
 - Covering with mats, such as clear plastic, jute, or synthetic fiber
 - Preservation of natural vegetation, including grass, trees, shrubs, and vines
- If operational BMPs are not sufficient to prevent stormwater contamination, structural controls must be implemented, including treatment or structural containment, which may include paving.

Washington State Water Quality Standards have specific limits on turbidity discharges. For specific information, reference WAC, Chapter 173-201A.

3.6. Other Activities

Several activities that do not fall into the previously described categories have a high risk for generating pollutants and contaminating stormwater and receiving waters. The required and recommended BMPs for these activities are presented as follows, according to the type of activity and the potential pollutants. Regardless of the activity, an overall approach to pollutant control should first emphasize pollution prevention, then the minimization of pollution, followed by pollution management.

Remember to also implement ~~all required citywide~~ [BMPs 1 through BMP 8 for all real property](#) from [Section 2.1Chapter 2](#).

3.6.1. ~~BMP 3231~~: *Commercial Animal Care and Handling*

This BMP applies to businesses and public agencies that perform animal care and handling including the management of animals at racetracks, kennels, day kennels, fenced pens, and veterinary offices and hospitals. It encompasses businesses or public agencies that provide boarding services for horses, dogs, cats, and other animals.

Description of Pollutants

Examples of animal handling activities that can generate pollutants are the cleanup of manure deposits and animal washing. Potential pollutants include fecal coliform bacteria, nutrients, soap, substances that increase biological oxygen demand (BOD) and suspended solids.

Required BMP Elements

The following source control BMPs or equivalent measures are required for all commercial animal handling activities:

- Implement ~~all citywide~~ [BMPs 1 through BMP 8 for all real property](#) (refer to [Section 2.1](#) ~~Chapter 2~~).
- Regularly sweep and clean animal-keeping areas to collect and properly dispose of droppings, uneaten food, and other potential stormwater contaminants. Do not discharge pollutants associated with these activities to the drainage system.
- If inlets/catch basins are in areas where animals are concentrated, close these drains and redirect stormwater to an appropriate treatment area, or cover area to prevent contact with stormwater.
- Do not hose down areas that contain potential stormwater contaminants if the water will drain to inlets/catch basins or receiving waters. Do not allow washwater to be discharged to inlets/catch basins or receiving waters without proper treatment.
- If animals are not leashed or in cages, the animal-keeping area must be surrounded by a fence or other means of preventing animals from moving out of the controlled area where BMPs are used.
- For outside surface areas that must be disinfected, use an unsaturated mop to spot clean the area. Do not allow wastewater runoff to enter the drainage system.

Recommended BMPs

Areas where animals are kept or exercised should be located where runoff will infiltrate and ~~not where it will not flow~~ [to drainage systems or receiving waters](#). ~~to catch basins or street drains.~~

3.6.2. *BMP 3332: Log Sorting and Handling*

This BMP applies to businesses and public agencies with paved or unpaved areas where logs are transferred, sorted, debarked, cut, and stored to prepare them for shipment; or for the production of dimensional lumber, plywood, chips, poles, or other products. Log yards are generally maintained at sawmills, shipping ports, and pulp mills.

Log sorting and handling activities may require an NPDES permit from Ecology. Refer to Ecology's website (<https://ecology.wa.gov/Water-Shorelines/Water-quality/Runoff-pollution/Stormwater> www.ecy.wa.gov/programs/wq/stormwater/index.html) or call Ecology at (360) 407-6000 to determine if the site activities trigger permit coverage. Required and recommended source control and treatment BMPs are described in detail in Publication [No. 04-10-031](#), *Industrial Stormwater General Permit Implementation Manual for Log Yards* (Ecology [2016b2004](#); [currently under revision](#)).

Refer to *S413 – BMPs for Log Sorting and Handling* in [Volume IV of the SWMMWW](#), ~~Volume IV~~ (Ecology [20192014](#)) for a description of the pollutants associated with this activity and the required BMP elements.

3.6.3. *BMP ~~3433~~: Boat Building, ~~Mooring~~, Maintenance, and Repair*

This BMP applies to businesses and public agencies that perform activities related to boat and shipbuilding and their repair and maintenance at boatyards, shipyards, ports, and marinas. Activities that can generate pollutants include pressure washing, surface preparation, paint removal, sanding, painting, engine maintenance and repairs, and material handling and storage. If conducted outdoors, all of these activities are associated with a high risk for contaminating receiving water.

Description of Pollutants

Potential pollutants include spent abrasive grits, solvents, oils, ethylene glycol, washwater, paint overspray, cleaners and detergents, anticorrosion compounds, paint chips, scrap metal, welding rods, resins, glass fibers, dust, and miscellaneous trash. Pollutant constituents include suspended solids, oils and greases, organic compounds, copper, lead, tin, and zinc.

Required BMP Elements

Activities associated with boatyard and shipyard operations may require an NPDES permit from Ecology. Refer to Ecology's website (<https://ecology.wa.gov/Water-Shorelines/Water-quality/Runoff-pollution/Stormwater>www.ecy.wa.gov/programs/wq/stormwater/index.html) or call Ecology at (360) 407-6000 to determine if the site activities trigger permit coverage.

The following BMPs or equivalent measures are required for boat and ship building, maintenance, and repair activities:

- Implement ~~all citywide~~ [BMPs 1 through BMP 8 for all real property](#) (refer to [Section 2.1](#) ~~Chapter 2~~).
- In addition to the ~~citywide~~ [BMP 5](#) spill control requirements, include a marine containment boom in spill kits for shipyards, boatyards, and marinas.
- Locate spill kits on all piers or docks.
- Immediately clean up any spills on dock, boat, or ship deck areas and dispose of the wastes properly.
- Immediately repair or replace leaking connections, valves, pipes, hoses, and equipment that can result in the contamination of stormwater.
- Relocate maintenance and repair activities onshore if feasible to reduce the potential for direct pollution of receiving waters.
- Perform paint and solvent mixing, fuel mixing, and similar handling of liquids onshore or in a location with proper containment so that nothing can spill directly into receiving waters.
- All liquids stored over water or on docks must have covered secondary containment.
- Store all batteries and oily parts in a covered container with a tight-fitting lid.
- Store materials such as paints, tools, and ground cloths indoors or in a covered area when not in use.
- Collect spent abrasives regularly and contain or store them under cover until they can be disposed of properly.

- Sweep and clean yard areas, docks, and boat ramps at least once each week or more often as needed. Do not hose them down. Properly dispose of the collected materials. Sweep dry docks before flooding.
- When washing, do not allow any pollutants, including soap, to enter the drainage system or receiving water.
- Use fixed platforms with appropriate plastic or tarpaulin barriers as work surfaces and for containment when work is performed on a vessel in the water to prevent material or overspray from contacting stormwater or receiving water. Use of the platform approach should be kept to a minimum. Only work that is done in compliance with NPDES requirements should be done over water.

The following BMPs or equivalent measures are required for boat and ship blasting and spray painting activities:

- Move the activity indoors or enclose, cover, and contain the activity. Prohibit outside spray painting, blasting, or sanding activities during windy conditions that render containment ineffective.
- Store materials such as paints, tools, and ground cloths indoors or in a covered area when not in use.
- Contain blasting and spray painting activities by hanging tarpaulins to block the wind and prevent dust and overspray from escaping. Do not perform uncontained spray painting, blasting, or sanding activities over open water without proper protection (e.g., overspray collection, drop clothes, booms).
- Use plywood and/or plastic sheeting to cover open areas between decks when sandblasting.
- Use ground cloths to collect drips and spills during painting and finishing operations, paint chips, and used blasting sand during sand blasting.
- Do not paint or use spray guns on or above the deck.

In the event of an accidental discharge of oil or hazardous material into receiving water or onto land if there is a potential for entry into receiving water, the responsible party must meet all notification requirements including, but not limited to, notifying the yard, port, or marina owner or manager; Ecology's Northwest Regional Office at (425) 649-7000; and the National Response Center at (800) 424-8802 (24-hour). If the spill can reach or has reached marine water, call the U.S. Coast Guard at (206) 217-6232.

Recommended BMPs

Although not required, the following BMPs are encouraged to further reduce the potential for stormwater contamination:

- Select the least toxic antifouling paint available.
- Routinely clean boat interiors and properly dispose of collected materials so that accumulated water, which must be drained from the boat, does not become contaminated.

3.6.4. *BMP ~~3534~~: Cleaning and Maintenance of Pools, Spas, Hot Tubs, and Fountains*

This BMP applies to all public and commercial swimming pools and spas, hot tubs, and fountains that use chemicals and/or are heated. Pools and spas at hotels, motels, apartments, and condominium complexes are also covered.

Description of Pollutants

Pollutants of concern include nutrients, suspended solids, chlorine, pH, and substances that increase chemical oxygen demand (COD).

Required BMP Elements

The following BMPs or equivalent measures are required for all pool, spa, hot tub, and fountain cleaning and maintenance activities:

- Implement ~~all citywide~~ [BMPs 1 through BMP 8 for all real property](#) (refer to [Section 2.1](#)~~Chapter 2~~).
- Discharge wastewater from backwashing and other maintenance activities related to cleaning to the sanitary sewer. Obtain all necessary permits for discharge to the sanitary sewer.
- For pool, spa, hot tub, and fountain draining, discharge to the sanitary sewer is the preferred method. Obtain all necessary permits for discharge to the sanitary sewer.
- If discharging to the ground, the discharge must comply with Ecology’s Groundwater Quality Standards (WAC, Chapter 173-200). Discharge must be moderated to allow infiltration of all water into the ground and not produce surface runoff.
- If discharge to the sanitary sewer or ground is not possible for draining a pool, spa, hot tub, or fountain, water may be discharged to a ditch or drainage system, provided that the following conditions have been met:
 - Dechlorinated/debrominated to 0.1 part per million (ppm) or less
 - Adjusted to a pH between 6.5 and 8.5
 - Adjusted to a temperature and dissolved oxygen concentration that will prevent an increase in temperature or a decrease in dissolved oxygen concentration in the downstream receiving water
 - Released at a controlled flow rate to prevent erosion and high flow impacts in the drainage ditch or downstream receiving water
 - Free of any coloration, dirt, [cleaning chemicals](#)~~suds~~, algae, filter media, or [acid cleaning](#)~~otherwise prohibited~~ wastes

Guidance on dechlorination is provided in the Department of Health’s Water System Design Manual, Publication 331-123 (DOH 2009). The Department of Health manual further references the American Water Works Association (AWWA) Standard for Disinfecting Water Mains (C651) and Standard for Disinfecting Water Storage Facilities (C652). Contact AWWA for more information. Contact a pool chemical supplier to obtain the neutralizing chemicals needed.

3.6.5. *BMP ~~3635~~: Deicing and Anti-icing Operations for Airports and Streets*

This BMP applies to businesses and public agencies that perform deicing and anti-icing operations used on highways, streets, airport runways, and aircraft to control ice and snow.

Description of Pollutants

Typically, ethylene glycol and propylene glycol are used on aircraft as deicers. The deicers commonly used on highways and streets include calcium magnesium acetate, calcium chloride, magnesium chloride, sodium chloride, urea, and potassium acetate.

Deicing and anti-icing chemicals become pollutants when they are conveyed to inlets/catch basins or to receiving water after application. Leaks and spills of these chemicals can also occur during their handling and storage.

Discharges of spent glycol in aircraft application areas are process wastewaters regulated under the Ecology NPDES permit. (Contact Ecology at (360) 407-6000 for details.) BMPs for aircraft deicers and anti-icers must be consistent with aviation safety requirements and the operational needs of the aircraft operator.

Required BMP Elements

The following BMPs or equivalent measures are required for deicing and anti-icing activities related to aircraft:

- Implement ~~all citywide~~ [BMPs 1 through BMP 8 for all real property](#) (refer to [Section 2.1](#) ~~Chapter 2~~).
- Conduct aircraft deicing and anti-icing applications in impervious containment areas. Collect spent deicing liquids (e.g., ethylene glycol) and anti-icing chemicals (e.g., urea) that drain from aircraft in deicing or anti-icing application areas and convey them to a sanitary sewer, treatment facility, or other approved disposal or recovery method. Divert runoff of deicing chemicals from paved gate areas to appropriate collection areas or conveyances for proper treatment or disposal.
- Do not allow spent deicing and anti-icing chemicals or contaminated stormwater to be discharged directly or indirectly from application areas, including gate areas, to a receiving water or groundwater.
- Transfer deicing and anti-icing chemicals on an impervious containment pad, or an equivalent spill/leak containment area, and store them in secondary containment areas.

The following BMPs or equivalent measures are required for deicing and anti-icing activities related to runways and taxiways:

- Avoid excessive application of de/anti-icing chemicals, which could contaminate stormwater.
- Store and transfer de/anti-icing materials on an impervious containment pad or an equivalent containment area.

The following BMPs or equivalent measures are required for deicing and anti-icing activities related to streets and highways:

- Select deicers and anti-icers that result in the least adverse environmental impact. Apply only as needed using minimum quantities.
- Where feasible and practical, use roadway deicers, such as calcium magnesium acetate, potassium acetate, or similar materials that cause less adverse environmental impact than urea and sodium chloride.
- Store and transfer deicing and anti-icing materials on an impervious containment pad.
- Sweep or clean up accumulated deicing and anti-icing materials and grit from roads as soon as possible after the road surface clears.
- Increase maintenance of stormwater structures as necessary.

Recommended BMPs

Although not required, the following BMPs are recommended to further reduce the potential for the contamination of stormwater and receiving waters:

Aircraft:

- Establish a centralized aircraft deicing and anti-icing facility, if feasible and practical, or conduct deicing and anti-icing in designated areas of the tarmac equipped with separate collection drains for the spent deicing liquids.
- Consider installing a recovery system for aircraft deicing and anti-icing chemicals, or contract with a chemical recycler, if practical.

Airport Runways and Taxiways:

- Include limits on toxic materials and phosphorus in the specifications for deicers and anti-icers, where applicable.
- Consider using anti-icing materials rather than deicers if they will result in less adverse environmental impact.
- Select cost-effective deicers and anti-icers that cause the least adverse environmental impact.

Streets and Highways:

- Intensify roadway cleaning in early spring to help remove particulates from road surfaces.
- Include limits on toxic metals in the specifications for deicers and anti-icers.

3.6.6. *BMP ~~3736~~: Maintenance and Management of Roof and Building Drains at ~~Manufacturing~~ Industrial and Commercial Buildings*

This BMP applies to businesses and public agencies where the roofs and sides of [manufacturing industrial or](#) ~~and~~ commercial buildings can be sources of pollutants when stormwater runoff results in the leaching of roofing materials, materials from building vents, air emissions, flashing, cleaning agents, and applied moss killers. Flaking paint and caulking can also be sources of pollutants.

Description of Pollutants

Vapors and entrained liquid and solid droplets and particles have been identified as potential pollutants in roof and building runoff. The pollutants identified include metals, solvents, low (acidic) and high (alkaline) pH, substances that increase biological oxygen demand (BOD), and organic compounds. Flaking paint or caulking may be a source of metals and organic compounds. [PCBs may leach out of old paint coatings and caulking materials from buildings, such as those built or renovated between 1950 and 1980.](#)

[Entities that conduct specific industrial activities are required to obtain an Industrial NPDES Permit for their stormwater discharges. For more information about whether an entity needs an NPDES permit, refer to Ecology's website \(<https://ecology.wa.gov/Water-Shorelines/Water-quality/Runoff-pollution/Stormwater>\) or call Ecology at \(360\) 407-6000.](#)

Required BMP Elements

The following BMPs or equivalent measures are required for all commercial and [manufacturing industrial](#) buildings to prevent and reduce stormwater pollution:

- Implement ~~all citywide~~ [BMPs 1 through BMP 8 for all real property](#) (refer to [Section 2.1](#) ~~Chapter 2~~).
- If leachates or emissions from buildings are suspected sources of stormwater pollutants, sample and analyze the stormwater draining from the building ~~or~~ [and](#) sediment from nearby catch basins.
- If a roof or building is identified as a source of stormwater pollutants, implement appropriate [operational](#) source control measures, such as air pollution control equipment, selection of [alternative](#) materials, operational changes, material recycling, ~~or~~ [process changes, remediation,](#) or treatment.
- Sweep areas routinely to remove pollutant residues.
- If operational methods do not prevent or reduce [zinc pollution from galvanized roofing or siding](#), paint/coat the galvanized surfaces as described in Publication 08-10-025, *Suggested Practices to Reduce Zinc Concentrations in Industrial Stormwater Discharges* (Ecology 2008) or treat the stormwater runoff.
- If operational BMPs are not sufficient to prevent stormwater contamination, structural controls must be implemented, including treatment or [structural](#) containment.

3.6.7. *BMP 3837: Maintenance and Operation of Railroad Yards*

This BMP applies to businesses and public agencies that perform activities at railroad yards not otherwise covered in this manual, including cleaning, maintenance, and repair of equipment and engines; fueling; waste disposal (including human waste); and all other yard maintenance activities (including vegetation management).

Description of Pollutants

Pollutant sources include litter; cleaning areas for locomotives, rail cars, and equipment; fueling areas; rail cargo; human waste disposal; outside material storage areas; erosion and loss of soil particles from the railroad bed; maintenance and repair activities at railroad terminals, switching yards, and maintenance yards; and herbicides used for vegetation management. Potential pollutants include oils and greases, suspended solids, substances that increase biological oxygen demand (BOD), fecal coliform, organic compounds, pesticides, and metals.

Required BMP Elements

The following BMPs or equivalent measures are required for railroad yards:

- Implement ~~all citywide~~ [BMPs 1 through BMP 8 for all real property](#) (refer to [Section 2.1 Chapter 2](#)).
- Implement the applicable BMPs in this volume specific to the activity that is occurring.
- Do not allow discharge from toilets to outside areas. Pump-out facilities should be used to service these units.
- Use drip pans at hose and pipe connections during liquid transfer and other leak-prone areas.
- During maintenance, do not discard debris or waste liquids along the tracks or in railroad yards.
- In areas subject to leaks or spills of oils or other chemicals, convey the contaminated stormwater to an appropriate treatment system such as the sanitary sewer, if approved by SPU and/or King County, or to an [American Petroleum Institute \(API\)](#) oil/water separator, coalescing plate oil/water separator for floating oils, or an appropriate treatment [BMP facility](#) (refer to [see Volume 3 – Project Stormwater Control](#)).
- [Place drip pans, absorbent pads/mats, or other containment measures below leaking vehicles \(including inoperable vehicles and equipment\) in a manner that catches leaks or spills. Drip pans or other containment measures must be managed to prevent overflowing or pass-through, and the contents must be disposed of properly. Absorbent pads or mats must be weighted down or secured so as not to be blown away by the wind, and changed out prior to becoming fully saturated.](#)
- [During routine maintenance, discharge locomotive cooling systems only after the locomotive has stopped and at a location where the coolant can be collected, managed, and then disposed of properly.](#)

- Handle wastes generated from large-scale equipment cleaning, such as locomotive, track equipment, or axle--cleaning operations, properly to avoid harming the environment and to comply with state and federal environmental regulations.
- Store any metal scrap generated from metal punching or other mechanical operations where it will not come in contact with stormwater.
- Place track mats under each rail/flange lubricator that is in service where track mats can be safely installed and maintained without danger to rolling stock or personnel.
- Install track mats at designated engine tie-up and/or outdoor locomotive parking locations (e.g., service tracks) in SWPPP-permitted areas and locomotives are unattended and idle for extended periods of time.
- Inspect and replace track mats, as necessary. Routinely inspect all track mats for tears or saturation and replace as necessary.
- Install spill containment pans/trays or track mats at designated locomotive and railcar maintenance facilities and fixed fueling areas to reduce environmental impacts due to potential spills under locomotives and other track equipment. Direct spill containment pans/trays to an oil/water separator where feasible for treatment or collect spilled chemicals for proper disposal.
- During locomotive fueling operations use drip pans or secondary containment to capture any fuel or oil seepage.
- Select cost-effective rail/flange lubricant that provides safe and effective rail operation while considering adverse environmental impacts. Consider both the chemical composition of the lubricant and the likelihood of off-rail transfer during rain events.
- Do not conduct heavy/major locomotive engine repairs on the rail line. Conduct heavy/major engine repairs at an established railroad maintenance facility.
- Store creosote-treated railroad ties in locations that reduce the potential to impact stormwater runoff.

3.6.8. *BMP 3938: Maintenance of Public and Private Utility Corridors and Facilities*

This BMP applies to businesses and public agencies that maintain utility corridors and associated equipment at petroleum product pipelines, natural gas pipelines, water pipelines, pump stations, electrical power transmission corridors, and rights-of-way.

Description of Pollutants

Corridors and facilities can be sources of pollutants, such as herbicides used for vegetation management and eroded soil particles generated from unpaved access roads. At pump stations, waste materials generated during maintenance activities are often temporarily stored outside, and thus can be a source of pollution into inlets/catch basins and receiving waters.

Additional potential pollutant sources include the leaching of preservatives from wood utility poles, polychlorinated biphenyls (PCBs) in older transformers, water that is removed from underground transformer vaults, and leaks or spills from petroleum pipelines. Potential pollutants are oils and greases, suspended solids, substances that increase biological oxygen demand (BOD), organic compounds, polychlorinated biphenyls, pesticides, and metals.

Required BMP Elements

The following BMPs or equivalent measures are required for activities related to the maintenance of public and utility corridors and facilities:

- Implement ~~all citywide~~ [BMPs 1 through BMP 8 for all real property](#) (refer to [Section 2.1](#) ~~Chapter 2~~).
- Implement ~~BMPs 22~~ [for](#) [\(Landscaping and Vegetation Management \(BMP 18\), including and integrated pest management \(IPM\). Implement S435 – BMPs for Pesticides and an Integrated Pest Management Program in Volume IV of the SWMMWW \(Ecology 2019\) \(referenced in BMP 49\). Appendix I of this manual contains information on developing an integrated pest management plan.](#)
- When water or sediments are removed from electric transformer vaults, determine whether contaminants are present before disposing of the water and sediments.
 - This includes inspecting for the presence of oil or oil sheen and determining from records or testing whether the transformers contain or contained polychlorinated biphenyls (PCBs).
 - If records or tests indicate that the sediment or water could contain PCBs ~~at concentrations greater than the allowable levels~~, manage the sediment or water in accordance with applicable federal and state regulations, including the federal rules for polychlorinated biphenyls (Code of Federal Regulations, Title 40, Part 761) and the state Model Toxics Control Act cleanup regulations (WAC, Chapter 173-340).
 - Water removed from the vaults can be discharged in accordance with the Code of Federal Regulations, Title 40, Section 761.79, and state regulations (Washington

Administrative Code, Chapters 173-201A and 173-200), or via the sanitary sewer if the requirements, including applicable permits, for such a discharge are met.

- Provide maintenance practices to prevent stormwater from accumulating and draining across and/or onto roadways. Stormwater should be conveyed through roadside ditches and culverts. The road should be crowned, outsloped, water barred, or otherwise left in a condition that is not conducive to erosion.
- Maintain ditches and culverts at an appropriate frequency to prevent plugging and flooding across the roadbed, with resulting overflow erosion.
- Apply the appropriate BMPs in this volume for the storage of waste materials that can contaminate stormwater.
- Within utility corridors, prepare maintenance procedures to minimize the erosion of soil. An implementation schedule may provide for a vegetative, gravel, or equivalent cover that minimizes thinly vegetated ground surfaces within the corridor.

Recommended BMPs

Although not required, the following BMPs can further prevent and minimize stormwater contamination:

- Maintain vegetation in roadside ditches that discharge to receiving waters to remove some pollutants associated with sediments carried by stormwater.
- When selecting utility poles for a specific location, consideration should be given to the potential environmental effects of the pole or poles during their storage, handling, and end use.
- If a wood product treated with chemical preservatives is used, it should be made in accordance with generally accepted industry standards such as the American Wood Preservers Association Standards.
- If the pole or poles will be placed in or near a drinking water well or a critical area, consider alternative materials or technologies. These include poles made of material(s) other than wood, such as fiberglass composites, metal, or concrete.
- Consider the use of other technologies and materials, such as sleeves or caissons for wood poles, when they are determined to be practical and available.
- As soon as practical, remove all litter from wire cutting and replacement operations.

3.6.9. *BMP 4039: Maintenance of Roadside Ditches*

This BMP applies to businesses and public agencies that perform activities related to the maintenance of roadside ditches, which can present a high risk of polluting stormwater because the ditches in which work is performed flow into the drainage system.

Description of Pollutants

Common road debris including particles from tire wear, dripped oil and other fluids; chemicals used in deicing; pesticides; herbicides; eroded or contaminated soil; and metals can be sources of stormwater pollutants.

Required BMP Elements

The following BMPs or equivalent measures are required for activities related to the maintenance of roadside ditches:

- Implement ~~all citywide~~ [BMPs 1 through BMP 8 for all real property](#) (refer to [Section 2.1 Chapter 2](#)).
- Implement BMPs for Landscaping and Vegetation Management (BMP [2218](#)), ~~including~~ [and integrated pest management \(IPM\). Implement S435 – BMPs for Pesticides and an Integrated Pest Management Program in Volume IV of the SWMMWW \(Ecology 2019\) \(referenced in BMP 49\).](#)
- Inspect roadside ditches regularly, as needed to identify sediment accumulations and areas of localized erosion.
- Clean ditches on a regular basis, as needed:
 - Keep ditches free of rubbish and debris.
 - Conduct ditch maintenance (seeding, fertilizer application, and harvesting) when most effective, usually in late spring and/or early fall and avoid maintenance during heavy rainfall.
 - Do not apply fertilizer unless needed to maintain vegetative growth.
 - Do not leave material from the ditch cleaning on roadway surfaces.
 - Sweep and remove dirt and debris that remains on the pavement at the completion of ditch cleaning operations.
 - Segregate clean materials from suspect or contaminated materials. Non-contaminated soils may be handled as “clean soils” and non-contaminated vegetative matter can be composted or disposed of in a municipal waste landfill, if permitted. Suspected contaminated or contaminated material removed from ditches must be tested and handled according to the Dangerous Waste Regulations (WAC, Chapter 173-303) unless testing indicates that it is not dangerous waste.
- Vegetation in ditches often prevents erosion and cleanses runoff:
 - Remove vegetation only when flow is blocked or excess sediments have accumulated.
 - Use grass vegetation, unless specified otherwise by SPU.
 - Establish vegetation from the edge of the pavement if possible or at least from the top of the slope of the ditch.

- Use temporary erosion and sediment control measures or re-vegetate as necessary to prevent erosion during ditch reshaping.
- Diversion ditches on top of cut slopes that are constructed to prevent slope erosion by intercepting surface drainage must be maintained to retain their diversion shape and capability.
- Inspect culverts on a regular basis for scour or sedimentation at the inlet and outlet, and repair as necessary. Give priority to culverts that are conveying perennial or salmon-bearing streams and to culverts near streams in areas of high sediment load, such as those near subdivisions during construction. Maintain trash racks to avoid damage, blockage or erosion of culverts.
- Waste generated from ditch maintenance, i.e., spoils and debris, may be contaminated and require specialized disposal. Refer to BMP 3 for waste disposal guidelines.
- Note: ~~that~~ Work in wet areas may be regulated by local, state, or federal laws ~~which~~ that impose obligations on the responsible party.

3.6.10. BMP 41: Potable Water Line Flushing, Water Tank Maintenance, and Hydrant Testing

This BMP applies to businesses and public agencies that perform activities related to potable water line flushing, water tank maintenance, and hydrant testing.

Description of Pollutants

Improper water line flushing, water tank maintenance, and hydrant testing may result in the discharge of sediments and materials to water bodies. Chemicals associated with water line flushing and water tank maintenance may be harmful to aquatic organisms and have an adverse effect on receiving water bodies.

Required BMP Elements

Required BMP elements are contained in S441 – BMPs for Potable Water Line Flushing, Water Tank Maintenance and Hydrant Testing in Volume IV of the SWMMWW (Ecology 2019).

3.6.11. BMP 42: Urban Streets

This BMP applies to businesses and public agencies that perform activities on urban streets.

Description of Pollutants

Urban streets can be a source of pollutants such as soil, fine dust, vegetation, nutrients, trash, oil and grease, vehicle combustion products, ice control salts, and pollutants that wash onto roadways from other areas.

Required BMP Elements

Required BMP elements are contained in S430 – [BMPs for Urban Streets in Volume IV of the SWMMWW \(Ecology 2019\)](#).

3.6.12. BMP 43: Nurseries and Greenhouses

This BMP applies to businesses and public agencies that operate nurseries and greenhouses.

Description of Pollutants

Nurseries and greenhouses can be a source of nutrients (phosphorus, nitrogen, etc.), sediment, bacteria, and organic matter that can degrade water quality.

Required BMP Elements

Required BMP elements are contained in *S449 – BMPs for Nurseries and Greenhouses* in Volume IV of the SWMMWW (Ecology 2019).

3.6.13. BMP 44: Color Events

This BMP applies to the general public, businesses, and religious and commercial entities that participate in, host, or sponsor color events.

Description of Pollutants

The dye materials used in color events can degrade water quality and impact aquatic life. Even if the dye is labeled “biodegradable” or “nontoxic,” it is not allowed to be discharged into storm drains or water bodies.

The term “biodegradable” on a product label does not mean that the product is safe or environmentally friendly. The product may degrade faster than alternative products but can still be harmful to the environment.

Required BMP Elements

Required BMP elements are contained in *S436 – BMPs for Color Events* in Volume IV of the SWMMWW (Ecology 2019).

3.6.14. BMP 45: Pet Waste

This BMP applies to the general public, businesses, and public agencies.

Description of Pollutants

Pet waste can carry viruses and bacteria that could cause disease and lead to beach closures or bans on shellfish harvesting.

Required BMP Elements

Required BMP elements are contained in *S440 – BMPs for Pet Waste* in Volume IV of the SWMMWW (Ecology 2019).

[3.6.15. BMP 46: Labeling Storm Drain Inlets on Your Property](#)

[This BMP applies to businesses and public agencies.](#)

[Description of Pollutants](#)

[Storm drain inlets themselves are not a source of pollutants; however, they can be used to discharge pollutants. Labels on storm drains can educate the public about prohibitions against dumping materials in storm drains.](#)

[Required BMP Elements](#)

[Required BMP elements are contained in *S442 – BMPs for Labeling Storm Drain Inlets on Your Property* in Volume IV of the SWMMWW \(Ecology 2019\).](#)

3.6.16. BMP 47: Well, Utility, Directional, and Geotechnical Drilling

This BMP applies to businesses and public agencies that are involved with drilling activities.

Description of Pollutants

Drilling activities can allow exposed soil and contaminated soil to wash into the drainage system.

Required BMP Elements

Required BMP elements are contained in *S446 – BMPs for Well, Utility, Directional and Geotechnical Drilling* in Volume IV of the SWMMWW (Ecology 2019).

3.6.17. BMP 48: Goose Waste

This BMP applies to the general public, businesses, and public agencies.

Description of Pollutants

Goose waste can contribute to algae growth in water due to its high nutrient content. Goose feces may contain pathogens that can affect people who use the water bodies.

Required BMP Elements

Required BMP elements are contained in *S452 – BMPs for Goose Waste* in Volume IV of the SWMMWW (Ecology 2019).

3.6.18. BMP 49: Pesticides and an Integrated Pest Management Program

This BMP applies to businesses and public agencies that use pesticides.

Description of Pollutants

Inadequate management of pesticides can allow them to enter stormwater and receiving water bodies, resulting in impacts on non-targeted organisms.

Required BMP Elements

Required BMP elements are contained in *Appendix I* of this manual and *S435 – BMPs for Pesticides and an Integrated Pest Management Program* in Volume *IV* of the *SWMMWW* (Ecology 2019).

[3.6.19. BMP 50: Storage of Dry Pesticides and Fertilizers](#)

[This BMP applies to businesses and public agencies that store dry pesticides and fertilizers.](#)

[Description of Pollutants](#)

[Inappropriate management of pesticides and fertilizers results in contamination of stormwater and receiving water bodies, which can degrade water quality and adversely affect fish and other aquatic life.](#)

[Required BMP Elements](#)

[Required BMP elements are contained in *S435 – BMPs for Pesticides and an Integrated Pest Management Program* in Volume IV of the SWMMWW \(Ecology 2019\).](#)

~~3.6.10~~ 3.6.20. *BMP 51: Irrigation*

This BMP applies to businesses and public agencies that have irrigation systems.

Description of Pollutants

Improper irrigation can encourage pest problems, leach nutrients, and make a lawn completely dependent on artificial watering.

Required BMP Elements

Required BMP elements are contained in *S450 – BMPs for Irrigation* in Volume IV of the *SWMMWW* (Ecology 2019).

3.6.21. BMP 52: Dock Washing

This BMP applies to the general public, businesses, and public agencies that are involved in dock washing.

Description of Pollutants

Washing docks can result in the discharge of dirt and other pollutants that may be toxic to aquatic life.

Required BMP Elements

Required BMP elements are contained in *S434 – BMPs for Dock Washing* in Volume IV of the SWMMWW (Ecology 2019).

3.6.22. BMP 53: Roof Vents

This BMP applies to businesses and public agencies that have roof vents.

Description of Pollutants

This BMP applies to processes that vent emissions to the roof, result in the accumulation of pollutants on roofs, or both. Pollutants from these processes may build up on roofs and may pollute stormwater runoff.

Required BMP Elements

Required BMP elements are contained in *S447 – BMPs for Roof Vents* in Volume IV of the *SWMMWW* (Ecology 2019).

3.6.23. BMP 54: Streets and Highways

This BMP applies to businesses and public agencies that maintain and apply deicers/anti-icers to streets and highways.

Description of Pollutants

This BMP applies to maintenance and deicing/anti-icing of streets and highways. Chemicals used for deicing/anti-icing may be harmful to aquatic organisms.

Required BMP Elements

Required BMP elements are contained in *S406 – BMPs for Streets and Highways* in Volume IV of the SWMMWW (Ecology 2019).

3.6.24. BMP 55: Fertilizer Application

[This BMP applies to businesses and public agencies that use fertilizers.](#)

Description of Pollutants

[Improper application of fertilizer can be a source of nutrients \(phosphorus, nitrogen, etc.\) that can degrade water quality.](#)

Required BMP Elements

[Required BMP elements are contained in *S443 – BMPs for Fertilizer Application* in Volume IV of the SWMMWW \(Ecology 2019\).](#)

CHAPTER 4 – REFERENCES

DOH. 2009. *Water System Design Manual*. Publication 331-123. Washington Department of Health, Olympia, Washington. December 2009.

Ecology. ~~2016a~~2003. ~~*Methods for Dust Control*~~~~*Techniques for Dust Prevention and Suppression*~~. Publication No. 96-433. Washington State Department of Ecology, Olympia, Washington. <https://fortress.wa.gov/ecy/publications/summarypages/96433.html>. Revised in ~~July 2016~~March 2003.

Ecology. ~~2016b~~2004. *Industrial Stormwater General Permit Implementation Manual for Log Yards*. Publication No. ~~umber~~ 04-10-031. Washington State Department of Ecology, Olympia, Washington. <https://fortress.wa.gov/ecy/publications/summarypages/0410031.html>. Revised in December 2016.

Ecology. 2008. *Suggested Practices to Reduce Zinc Concentrations in Industrial Stormwater Discharges*. Publication No. 08-10-025. Washington State Department of Ecology, Olympia, Washington. <https://fortress.wa.gov/ecy/publications/summarypages/0810025.html>.

Ecology. 2011. *Vehicle and Metal Recyclers: A Guide for Implementing the Industrial Stormwater General National Pollutant Discharge Elimination System Permit Requirements*. Publication No. 94-146. Washington State Department of Ecology, Olympia, Washington. <https://fortress.wa.gov/ecy/publications/summarypages/94146.html>. Revised in March 2011.

Ecology. 2012. *Vehicle and Equipment Washwater Discharges: Best Management Practices Manual*. Publication No. WQ-R-95-56. Washington State Department of Ecology, Olympia, Washington. <https://fortress.wa.gov/ecy/publications/SummaryPages/95056.html>. Revised in November 2012.

Ecology. ~~2019~~2014. *Stormwater Management Manual for Western Washington*. 5 vols. Publication No. ~~19-10-021~~14-10-055, a revision of Publication No. ~~12-10-030~~. Washington State Department of Ecology, Olympia, Washington. ~~July 2019~~Modified in December 2014. <https://ecology.wa.gov/Regulations-Permits/Guidance-technical-assistance/Stormwater-permittee-guidance-resources/Stormwater-manuals>.<https://fortress.wa.gov/ecy/publications/SummaryPages/1410055.html>

U.S. EPA. 1997. *Innovative Uses of Compost: Disease Control for Plants and Animals*. Publication EPA-530-F-97-044. U.S. Environmental Protection Agency.

This page intentionally left blank.

**THIS COVER TO BE REPLACED
WITH SPU-PROVIDED COVER**
VOLUME 5 —
ENFORCEMENT

CITY OF SEATTLE
SEATTLE PUBLIC UTILITIES
DEPARTMENT OF CONSTRUCTION AND INSPECTIONS

July 2021

Note:

Some pages in this document have been purposely skipped or blank pages inserted so that this document will copy correctly when duplexed.

Table of Contents

CHAPTER 1 - Introduction..... 1-1

CHAPTER 2 - Penalty Assessment Matrix 2-1

 2.1. Enforcement Penalty Matrix..... 2-1

 2.2. Application of Penalty Criteria..... 2-2

Tables

Table 1. Enforcement Penalty Matrix. 2-1

Table 2. Penalty Points Rating and Corresponding Penalty Amount..... 2-1

CHAPTER 1 – INTRODUCTION

The City of Seattle Department of Construction and Inspection (SDCI) and Seattle Public Utilities (SPU) produced this document as a joint Directors' Rule (DR) to interpret the enforcement provisions that are described in the Seattle Municipal Code (SMC) 22.800 through 22.808 (Stormwater Code). This volume is designed to help clarify the application of enforcement in Seattle.

If the Director finds a violation of the Stormwater Code has occurred or is occurring, a Notice of Violation (NOV) or an Order is given to the responsible party of that violation. The civil penalty attached with the NOV or Order is determined using the enforcement penalty matrix described below.

CHAPTER 2 – PENALTY ASSESSMENT MATRIX

2.1. Enforcement Penalty Matrix

The enforcement penalty matrix (Table 1) is composed of a set of criteria formulated as questions for the Director to evaluate and answer. The Director uses the guidelines of *Section 1.3* to determine the total points to be assessed according to the violation. Once the total amount of penalty points is determined, a rating and a corresponding penalty amount is established (Table 2).

Table 1. Enforcement Penalty Matrix.

Enforcement Evaluation Criterion	No (0 points)	Possibly (1 point)	Probably (2 points)	Definitely (3 points)
Public Health Risk?				
Environmental Damage or Adverse Impacts to Infrastructure?				
Willful or Knowing Violation?				
Unresponsive in Correcting Action?				
Improper or Inadequate Operation or Maintenance?				
Failure to Obtain and Comply with Necessary Permits, Certifications, and Approvals?				
Economic Benefit to Non-Compliance?				
Repeat Violation?				

Table 2. Penalty Points Rating and Corresponding Penalty Amount.

Rating	1–2	3–4	5–8	9–11	12–14	15
Penalty	\$250	\$500	\$1,000	\$1,500	\$2,000	\$2,500
Rating	16	17	18	19	20+	
Penalty	\$3,000	\$3,500	\$4,000	\$4,500	\$5,000	

2.2. Application of Penalty Criteria

The framework below provides guidance on how to rate each criterion of the enforcement penalty matrix. The civil penalty is determined by the total score of the matrix.

1. Did the violation pose a public health risk¹?
 - a. Answer “no” if there is no evidence to support a claim of public health risk or adverse health effects.
 - b. Answer “possibly” if evidence supports a claim of public health risk and there is a plausible connection between this violation and health effect.
 - c. Answer “probably” if evidence supports a claim of public health risk and there is a likely connection between this violation and health effect.
 - d. Answer “definitely” if there is direct evidence linking public health risk or adverse effects with the violation.
2. Did the violation result in environmental damage or adverse impacts to infrastructure²?
 - a. Answer “no” if there is no evidence to support a claim of environmental or infrastructure damage.
 - b. Answer “possibly” if environmental or infrastructure damage can be inferred from evidence or knowledge of the effects of the violation.
 - c. Answer “probably” if there is evidence to support a claim of environmental or infrastructure damage and there is a likely connection between the violation and the damage/impairment.
 - d. Answer “definitely” if there is direct evidence linking environmental or infrastructure damage with the violation.
3. Was the action a willful and knowing violation?
 - a. Answer “no” if the violator obviously did not know that the action or inaction constituted a violation.
 - b. Answer “possibly” if the violator should have known.
 - c. Answer “probably” if it is likely the violator knew.
 - d. Answer “definitely” if the violator clearly knew or was previously informed by inspectors.

¹ Risk involving the physical or social well-being of a community or environment.

² Results in damage to publicly owned infrastructure that contributes to its impairment.

4. Was the responsible party³ unresponsive in correcting the violation?
 - a. Answer “no” if the violation was corrected as soon as the responsible party learned of it.
 - b. Answer “possibly” if the violation was corrected in a less timely and cooperative fashion.
 - c. Answer “probably” if the responsible person made some attempt to correct the problem, but did not correct it.
 - d. Answer “definitely” if the responsible party made no attempt to correct the violation.
5. Was the violation a result of improper operation, inadequate maintenance, or inadequate implementation of a required plan that addresses stormwater management (e.g., O&M⁴ manual, DCP⁵, SWPPP⁶, or TESC⁷ plan)?
 - a. Answer “no” if the violation was not the result of improper operation or inadequate maintenance.
 - b. Answer “possibly” if the facility has an O&M manual, DCP, SWPPP, or TESC plan, but it is out of date or inadequate.
 - c. Answer “probably” if there is no O&M manual, DCP, SWPPP, or TESC plan and the violation would have been less severe if the plan were developed and followed.
 - d. Answer “definitely” if the facility has no O&M manual, DCP, SWPPP, or TESC plan or did not follow its plan AND the violation was clearly the result of improper operation or maintenance.
6. Did the responsible party fail to obtain and comply with relevant permits, certifications, and approvals that require or would have required the responsible party to manage stormwater in a manner that could have prevented or mitigated the Code violation?
 - a. Answer “no” if the paperwork was complete and appropriate for the job or task that caused the violation.
 - b. Answer “possibly” if the responsible party obtained and received approval for some but not all of the required permit(s).

³ Owners, operators, and occupants of property, and any person causing or contributing to a violation of the City Code are considered a “responsible party” for purposes of a Code violation (SMC, Section 22.801.190).

⁴ Operations and maintenance

⁵ Drainage Control Plan

⁶ Stormwater Pollution Prevention Plan

⁷ Temporary Erosion and Sediment Control

- c. Answer “probably” if the responsible party obtained some but not all of the required permit(s) and did not receive approvals for the job or task that caused the violation.
 - d. Answer “definitely” if the responsible party either did not obtain the necessary permits or did obtain permits but did not comply with their conditions.
7. Did anyone benefit economically⁸ from non-compliance?
- a. Answer “no” if it is clear that no one gained an economic benefit.
 - b. Answer “possibly” if someone might have benefited.
 - c. Answer “probably” if anyone benefited, but the benefit is not quantifiable.
 - d. Answer “definitely” if the economic benefit is quantifiable.
8. Is this violation a repeat violation⁹?
- a. Answer “no” to indicate that there have been no prior violations.
 - b. Answer “possibly” to indicate that there has been one prior violation.
 - c. Answer “probably” to indicate that there have been two prior violations.
 - d. Answer “definitely” to indicate that there have been three or more prior violations.

⁸ Gain and/or no loss in resources.

⁹ From Stormwater Code (SMC, Section 22.801.190): “Repeat violation” means a prior violation of this subtitle within the preceding 5 years that became a final order or decision of the Director or a court. The violation does not need to be the same nor occur on one site to be considered repeat.

APPENDIX A

Definitions

This Cover to be Replaced in PDF
with SPU-Provided Cover

Note:

Some pages in this document have been purposely skipped or blank pages inserted so that this document will copy correctly when duplexed.

- “Agency” means any governmental entity or its subdivision.
- “Agency, City” means “City agency” as defined in Section 25.09.520.
- “Approved” means approved by the Director.
- “Aquatic life use” means “aquatic life use” as defined in WAC 173-201A-200. For the purposes of this subtitle, at minimum the following water bodies are designated for aquatic life use: small lakes, creeks, and ~~freshwater~~ fresh designated receiving waters.
- “Arterial” means “arterial” as defined in Section 11.14.035.
- “Basic treatment facility” means a drainage control facility designed to reduce concentrations of total suspended solids in drainage water.
- “Basic treatment receiving water” means:
 - All marine waters, including Puget Sound;
 - Lake Union;
 - Lake Washington;
 - Ship Canal and bays between Lake Washington and Puget Sound; and
 - Duwamish River.
- “Best management practice” (BMP) means a schedule of activities, prohibitions of practices, operational and maintenance procedures, structural facilities, or managerial practice or device that, when used singly or in combination, prevents, reduces, or treats contamination of drainage water, prevents or reduces soil erosion, or prevents or reduces other adverse effects of drainage water. When the Directors develop rules and/or manuals prescribing BMPs for particular purposes, whether or not those rules and/or manuals are adopted by ordinance, BMPs ~~prescribed~~ specified in the rules and/or manuals shall be the BMPs required for compliance with this subtitle.
- “Building permit” means a document issued by ~~SDC~~ the Seattle Department of Construction and Inspections authorizing construction or other specified activity in accordance with the Seattle Building Code (~~Chapter 22.100~~) or the Seattle Residential Code (~~Chapter 22.150~~).
- “Capacity-constrained system” means a drainage system or public combined sewer that the Director of SPU has determined to have inadequate capacity to carry existing and anticipated loads, or a drainage system that includes ditches or culverts.
- “Certified Erosion and Sediment Control Lead” (CESCL) means an individual who has current certification through an approved erosion and sediment control training program that meets the minimum training standards established by Ecology.
- “Civil engineer, licensed” means a person who is licensed by the State of Washington to practice civil engineering.
- “City agency” means “City agency” as defined in Section 25.09.520.
- “Combined sewer.” See “public combined sewer.”
- “Combined sewer basin” or “public combined sewer basin” means the area tributary to a public combined sewer feature, including, but not limited to, a combined sewer overflow outfall, trunk line connection, pump station, or regulator.

- “Compaction” means the densification, settlement, or packing of earth material or fill in such a way that permeability is reduced by mechanical means.
- “Construction Stormwater Control Plan” means a document that explains and illustrates the measures to be taken on the construction site to control, prevent erosion and discharge of sediment and other pollutants on a construction project.
- “Containment area” means the area designated for conducting pollution-generating activities for the purposes of implementing source controls or designing and installing source controls or treatment facilities.
- “Contaminate” means the addition of sediment, any other pollutant or waste, or any illicit or prohibited discharge.
- “Creek” means a Type 2-5S, F, Np or Ns water as defined in WAC 222-16-031, or as defined in WAC 222-16-030 after state water type maps are adopted, and is used synonymously with “stream.”
- “Damages” means monetary compensation for harm, loss, costs, or expenses incurred by the City, including, but not limited, to the following: costs of abating or correcting violations of this subtitle; fines or penalties the City incurs as a result of a violation of this subtitle; and costs to repair or clean the public drainage system or public combined sewer as a result of a violation. For the purposes of this subtitle, damages do not include compensation to any person other than the City.
- “Designated receiving waters” means the Duwamish River, Puget Sound, Lake Washington, Lake Union, Elliott Bay, Portage Bay, Union Bay, the Lake Washington Ship Canal, and other receiving waters determined by the Director of SPU and approved by Ecology as having sufficient capacity to receive discharges of drainage water such that a site discharging to the designated receiving water is not required to implement flow control.
- “Detention” means temporary storage of drainage water for the purpose of controlling the drainage discharge rate.
- “Development” means the following activities:
 1. Class IV-general forest practices that are conversions from timberland to other uses;
 - ~~1-2.~~ Land disturbing activity ~~or;~~
 3. The addition or replacement of hard surfaces~~surfaces;~~
 4. Expansion of a building footprint or addition or replacement of a structure;
 5. Structural development, including construction, installation, or expansion of a building or other structure;
 6. Seeking approval of a building permit, other construction permit, grading permit, or master use permit that involves any of the foregoing activities; and
 - ~~2-7.~~ Seeking approval of subdivision, short plat, unit lot subdivision, or binding site plans, as defined and applied in Chapter 58.17 RCW, or other master use permit.

Development is a type of project.

- “Director” means the Director of the Department authorized to take a particular action, and the Director’s designees, who may be employees of that department or another City department.
- “Director of SDCI” means the Director of the [Seattle Department of Construction and Inspections of The City of Seattle and/](#) or the designee of [Planning and Developmentthe Director of the Seattle Department of Construction and Inspections](#), who may be employees of that department or another City department.
- “Director of SDOT” means the Director of Seattle Department of Transportation of The City of Seattle [and/](#)or the designee of the Director of Seattle Department of Transportation, who may be employees of that department or another City department.
- “Director of SPU” means the [Director-General Manager and Chief Executive Officer](#) of Seattle Public Utilities of The City of Seattle [and/](#)or the designee of the [Director General Manager and Chief Executive Officer](#) of Seattle Public Utilities, who may be employees of that department or another City department.
- “Discharge point” means the location from which drainage water from a site is released.
- “Discharge rate” means the rate at which drainage water is released from a site. The discharge rate is expressed as volume per unit of time, such as cubic feet per second.
- ~~“DPD” means the Department of Planning and Development.~~
- “Drainage basin” means the geographic and hydrologic tributary area or subunit of a watershed through which drainage water is collected, regulated, transported, and discharged to receiving waters.
- “Drainage basin plan” means a plan to manage the quality and quantity of drainage water in a watershed or a drainage basin, including watershed action plans.
- “Drainage control” means the management of drainage water. Drainage control is accomplished through one or more of the following: collecting, conveying, and discharging drainage water; controlling the discharge rate from a site; controlling the flow duration from a site; controlling the quantity from a site; and separating, treating or preventing the introduction of pollutants.
- “Drainage control facility” means any facility, including best management practices, installed or constructed for the purpose of controlling the discharge rate, flow duration, quantity, and/or quality of drainage water.
- “Drainage control plan” means a plan for collecting, controlling, transporting and disposing of drainage water falling upon, entering, flowing within, and exiting the site, including designs for drainage control facilities.
- “Drainage system” means a system intended to collect, convey and control release of only drainage water. The system may be either publicly or privately owned or operated, and the system may serve public or private property. It includes components such as pipes, ditches, culverts, [curbs, gutters](#), and drainage control facilities. Drainage systems are not receiving waters.
- “Drainage water” means stormwater and all other discharges that are permissible pursuant to subsection 22.802.030.A.

- “Earth material” means any rock, gravel, natural soil, fill, or re-sedimented soil, or any combination thereof, but does not include any solid waste as defined by RCW 70.95.
- “Ecology” means the Washington State Department of Ecology.
- “Effective [impervioushard](#) surface” means those [impervious hard](#) surfaces that are connected via sheet flow or discrete conveyance to a drainage system.
- “Enhanced treatment facility” means a drainage control facility designed to reduce concentrations of dissolved metals in drainage water.
- “Environmentally critical area” (ECA) means an area designated in Section 25.09.[020-012](#).
- “EPA” means the United States Environmental Protection Agency.
- “Erodible or leachable materials” means wastes, chemicals, or other substances which, when exposed to rainfall, measurably alter the physical or chemical characteristics of the drainage water. Examples include: erodible soils that are stockpiled; leachable materials that are stockpiled; uncovered process wastes; manure; fertilizers; oily substances; ashes, kiln dust; and garbage dumpster leakage.
- “Erosion” means the wearing away of the ground surface as a result of mass wasting or of the movement of wind, water, ice, or other geological agents, including such processes as gravitational creep. Erosion also means the detachment and movement of soil or rock fragments by water, wind, ice, or gravity.
- “Excavation” means the mechanical removal of earth material.
- “Exception” means relief from a requirement of this subtitle to a specific project.
- “Existing grade” means “existing grade” as defined in Section 22.170.050.
- “Fill” means a deposit of earth material placed by artificial means.
- “Flow control” means controlling the discharge rate, flow duration, or both of drainage water from the site through means such as infiltration or detention.
- “Flow control facility” means a drainage control facility for controlling the discharge rate, flow duration, or both of drainage water from a site.
- “Flow duration” means the aggregate time that peak flows are at or above a particular flow rate of interest.
- “Garbage” means putrescible waste.
- “Geotechnical engineer” or “Geotechnical/civil engineer” means a person licensed by The State of Washington as a professional civil engineer who has expertise in geotechnical engineering.
- “Grading” means excavation, filling, in-place ground modification, removal of roots or stumps that includes ground disturbance, stockpiling of earth materials, or any combination thereof, including the establishment of a grade following demolition of a structure.
- “Green stormwater infrastructure” means distributed BMPs, integrated into a project design, that use infiltration, filtration, storage, or evapotranspiration, or provide stormwater reuse.

- “Groundwater” means water in a saturated zone or stratum beneath the surface of land or below a surface water body. Refer to Ground Water Quality Standards, Chapter 173-200 WAC.
- “Hard surface” means an impervious surface, a permeable pavement, or a vegetated roof.
- “High-use sites” means sites that typically generate high concentrations of oil due to high traffic turnover or the frequent transfer of oil. High-use sites include:
 - An area of a commercial or industrial site subject to an expected average daily traffic (ADT) count equal to or greater than 100 vehicles per 1,000 square feet of gross building area;
 - An area of a commercial or industrial site subject to petroleum storage and transfer in excess of 1,500 gallons per year, not including routinely delivered heating oil;
 - An area of a commercial or industrial site subject to parking, storage or maintenance of 25 or more vehicles that are over 10 tons gross weight (trucks, buses, trains, heavy equipment, etc.);
 - A road intersection with a measured ADT count of 25,000 vehicles or more on the main roadway and 15,000 vehicles or more on any intersecting roadway, excluding projects proposing primarily pedestrian or bicycle use improvements.
- “Illicit connection” means any direct or indirect infrastructure connection to the public drainage system or receiving water that is not intended, not permitted, or not used for collecting drainage water.
- “Impervious surface” means any surface exposed to rainwater from which most water runs off. Impervious surfaces include, but are not limited to, roof tops, walkways, patios, driveways, formal planters, parking lots or storage areas, concrete or asphalt paving, areas with underdrains designed to remove stormwater from subgrade (e.g., playfields, athletic fields, rail yards), gravel surfaces subjected to vehicular traffic, compact gravel, packed earthen materials, and oiled macadam or other surfaces which similarly impede the natural infiltration of stormwater. Open, uncovered retention/detention facilities shall not be considered as impervious surfaces for the purposes of determining whether the thresholds for application of minimum requirements are exceeded. Open, uncovered retention/detention facilities shall be considered impervious surfaces for purposes of stormwater modeling.
- “Industrial activities” means material handling, transportation, or storage; manufacturing; maintenance; treatment; or disposal. Areas with industrial activities include plant yards, access roads and rail lines used by carriers of raw materials, manufactured products, waste material, or by-products; material handling sites; refuse sites; sites used for the application or disposal of process waste waters; sites used for the storage and maintenance of material handling equipment; sites used for residual treatment, storage, or disposal; shipping and receiving areas; manufacturing buildings; storage areas for raw materials, and intermediate and finished products; and areas where industrial activity has taken place in the past and significant materials remain and are exposed to stormwater.
- “Infiltration” means the downward movement of water from the surface to the subsoil. “Infiltration facility” means a drainage control facility that temporarily stores, and then percolates, drainage water into the underlying soil.

- “Integrated Drainage Plan” means a plan developed, reviewed, and approved pursuant to subsection 22.800.080.E.
- “Interflow” means that portion of rainfall and other precipitation that infiltrates into the soil and moves laterally through the upper soil horizons until intercepted by a stream channel or until it returns to the surface.
- “Inspector” means a City inspector, their designee, or licensed civil engineer performing the inspection work required by this subtitle.
- “Land disturbing activity” means any activity that results in a change in the existing soil cover, both vegetative and nonvegetative, or the existing topography. Land disturbing activities include, but are not limited to, clearing, grading, filling, excavation, or addition of new or the replacement of hard surface. Compaction, excluding hot asphalt mix, that is associated with stabilization of structures and road construction is also considered a land disturbing activity. Vegetation maintenance practices, including landscape maintenance and gardening, are not considered land disturbing activities. Stormwater facility maintenance is not considered land disturbing activity if conducted according to established standards and procedures.
- “Large project” means a project including:
 1. ~~5,000~~ Five thousand square feet or more of new plus replaced hard surface;
 2. ~~o~~ One acre or more of land disturbing activity;
 3. ~~e~~ Conversion of 3/4 acres or more of vegetation to lawn or landscaped area; or
 4. ~~e~~ Conversion of 2.5 acres or more of native vegetation to pasture.
- “Listed creeks” means Blue Ridge Creek, Broadview Creek, Discovery Park Creek, Durham Creek, Frink Creek, Golden Gardens Creek, Kiwanis Ravine/Wolfe Creek, Licton Springs Creek, Madrona Park Creek, Mee-Kwa-Mooks Creek, Mount Baker Park Creek, Puget Creek, Riverview Creek, Schmitz Creek, Taylor Creek, and Washington Park Creek.
- “Master use permit” means a ~~document issued by SDCI giving permission for development or~~ “master use of land or street right-of-way permit” as defined in accordance with Chapter subsection 23.76-84A.025.
- “Maximum extent feasible” means the requirement is to be fully implemented, constrained only by the physical limitations of the site, practical considerations of engineering design, and reasonable considerations of financial costs.
- “Municipal stormwater NPDES permit” means the permit issued to the City under the federal Clean Water Act for public drainage systems within the City limits.
- “Native vegetation” means “native vegetation” as defined in Section 25.09.520.
- “New hard surface” means a surface that is: changed from a pervious surface to a hard surface (e.g., converting lawn to permeable pavement, resurfacing by upgrading from dirt to gravel, a bituminous surface treatment (“chip seal”), asphalt, concrete, or a hard surface structure); or upgraded from gravel to chip seal, asphalt, concrete, or a hard surface structure; or from a hard surface to a hard surface structure. Note that if asphalt or concrete has been overlaid by a chip seal, the existing condition should be considered as asphalt or concrete.

- “New impervious surface” means a surface that is: changed from a pervious surface to an impervious surface (e.g., resurfacing by upgrading from dirt to gravel, a bituminous surface treatment (“chip seal”), asphalt, concrete, or an impervious structure); or upgraded from gravel to chip seal, asphalt, concrete, or an impervious structure; or from a pervious surface to an impervious structure. Note that if asphalt or concrete has been overlaid by a chip seal, the existing condition should be considered as asphalt or concrete.
- “Non-listed creeks” means any creek not identified in the definition of “Listed creeks” in Section 22.801.130.
- “NPDES” means National Pollutant Discharge Elimination System, the national program for controlling discharges under the federal Clean Water Act.
- “NPDES permit” means an authorization, license or equivalent control document issued by the EPA or Ecology to implement the requirements of the NPDES program.
- “Nutrient-critical receiving water” means a surface water or water segment that is determined to be impaired due to phosphorus contributed by stormwater, as prescribed specified in rules promulgated by the Director of SPU which shall be based on consideration of water bodies reported by Ecology, and approved by EPA, under Category 5 (impaired) under Section 303(d) of the Clean Water Act for total phosphorus through Ecology’s Water Quality Assessment.
- “Oil control treatment facility” means a drainage control facility designed to reduce concentrations of oil in drainage water.
- “On-site BMP” means a best management practice identified in subsection 22.805.070.D.
- “Owner” means any person having title to and/or responsibility for, a building or property, including a lessee, guardian, receiver or trustee, and the owner’s duly authorized agent.
- “Parcel-based project” means any project that is not a roadway project, single-family residential project, sidewalk project, or trail project. The boundary of the public right-of-way shall form the boundary between the parcel and roadway portions of a project.
- “Person” means an individual, receiver, administrator, executor, assignee, trustee in bankruptcy, trust estate, firm, partnership, joint venture, club, company, joint stock company, business trust, municipal corporation, the State of Washington, political subdivision or agency of the State of Washington, public authority or other public body, corporation, limited liability company, association, society or any group of individuals acting as a unit, whether mutual, cooperative, fraternal, nonprofit or otherwise, and the United States or any instrumentality thereof.
- “Pervious surface” means a surface that is not impervious. See also “impervious surface.”
- “Phosphorus treatment facility” means a drainage control facility designed to reduce concentrations of phosphorus in drainage water.
- “Plan” means a graphic or schematic representation, with accompanying notes, schedules, specifications and other related documents, or a document consisting of checklists, steps, actions, schedules, or other contents that has been prepared pursuant to this subtitle, such as a site plan, drainage control plan, construction

stormwater control plan, stormwater pollution prevention plan, or integrated drainage plan.

- “Pollution-generating activity” means any activity that is regulated by the joint SPU/SDCI Directors’ Rule titled “Seattle Stormwater Manual” at “Volume 4 - Source Control” or any activity with similar impacts on drainage water. These activities include, but are not limited to: cleaning and washing activities; transfer of liquid or solid material; production and application activities; dust, soil, and sediment control; commercial animal care and handling; log sorting and handling; boat building, mooring, maintenance, and repair; logging and tree removal; mining and quarrying of sand, gravel, rock, peat, clay, and other materials; cleaning and maintenance of swimming pool and spas; deicing and anti-icing operations for airports and streets; maintenance and management of roof and building drains at manufacturing and commercial buildings; maintenance and operation of railroad yards; maintenance of public and utility corridors and facilities; and maintenance of roadside ditches.
- “Pollution-generating hard surface” means those hard surfaces considered to be a significant source of pollutants in drainage water. See definition of pollution-generating impervious surface in this Section 22.801.170 for surfaces that are considered significant sources of pollutants in drainage water. In addition, permeable pavement subject to vehicular use or other pollutants as described in the definition for pollution-generating impervious surfaces is a pollution-generating hard surface.
- “Pollution-generating impervious surface” means those impervious surfaces considered to be a significant source of pollutants in drainage water. Such surfaces include those that are subject to any of the following: vehicular use; ~~certain~~ industrial activities; ~~or~~ storage of erodible or leachable materials, wastes, or chemicals, and ~~which that~~ receive direct rainfall or the run-on or blow-in of rainfall; Such surfaces also include roofs subject to venting of significant sources of pollutants; and metal roofs unless coated with an inert, non-leachable material (e.g., baked-on enamel coating).
 - A surface, whether paved or not, shall be considered subject to vehicular use if it is regularly used by motor vehicles. The following are considered regularly used surfaces: roads; unvegetated road shoulders; bike lanes within the traveled lane of a roadway; driveways; parking lots; unfenced fire lanes; vehicular equipment storage yards; rail lines and railways; and airport runways.
 - The following are not considered regularly used by motor vehicles: sidewalks and trails not subject to drainage from roads for motor vehicles; paved bicycle pathways separated from and not subject to drainage from roads for motor vehicles; fenced fire lanes; and infrequently used maintenance access roads with a recurring routine vehicle use of no more than once per day.
- “Pollution-generating pervious surface” means any ~~non-impervious pervious~~ surface subject to any of the following: vehicular use; industrial activities; ~~or~~ storage of erodible or leachable materials, wastes, or chemicals, and that ~~receives~~ receive direct rainfall or run-on or blow-in of rainfall; use of pesticides and fertilizers; ~~or~~ loss of soil. Typical pollution-generating pervious surfaces include lawns, landscaped areas, golf courses, parks, cemeteries, and sports fields (natural and artificial turf).
- “Pre-developed condition” means the vegetation and soil conditions that are used to determine the allowable post-development discharge peak flow rates and flow durations, such as pasture or forest.

- “Private drainage system” means a drainage system that is not a public drainage system.
- “Project” means ~~the addition~~ any proposed action to alter or replacement of hard surface or the undertaking of land disturbing activity on ~~develop~~ a site. Development is a type of project.
- “Project site” means that portion of a property, properties, or ~~right~~ rights-of-way subject to ~~addition or replacement of land-disturbing activities, new hard surfaces, or replaced~~ hard surfaces or the undertaking of land disturbing activity.
- “Public combined sewer” means a publicly owned and maintained system which carries drainage water and wastewater and flows to a publicly owned treatment works.
- “Public drainage system” means a drainage system owned or operated by ~~the~~ The City of Seattle.
- “Public place” means and includes streets, avenues, ways, boulevards, drives, places, alleys, sidewalks, and planting (parking) strips, squares, triangles and right-of-way for public use and the space above or beneath its surface, whether or not opened or improved.
- “Public sanitary sewer” means the sanitary sewer that is owned or operated by ~~the~~ The City of Seattle.
- “Public storm drain” means the part of a public drainage system that is wholly or partially piped, owned or operated by a City agency and designed to carry only drainage water.
- “Real property” means “real property” as defined in Chapter 3.110.
- “Receiving water” means the surface water, such as a creek, stream, river, lake, wetland or marine water, or groundwater, receiving drainage water. Drainage systems and public combined sewers are not receiving waters.
- “Repeat violation” means a prior violation of this subtitle within the preceding 5 years that became a final order or decision of the Director or a court. The violation does not need to be the same nor occur on one site to be considered repeat.
- “Replaced hard surface” or “replacement of hard surface” means, for structures, the removal down to the foundation and replacement; ~~of hard surfaces down to the foundation~~ and, for other hard surfaces, the removal down to existing subgrade or base course and replacement.
- “Replaced impervious surface” or “replacement of impervious surface” means, for structures, the removal down to the foundation and replacement; ~~of impervious surfaces down to the foundation~~ and, for other impervious surfaces, the removal down to existing subgrade or base course and replacement.
- “Responsible party” means all of the following persons:
 1. Owners, operators, and occupants of property; and
 2. Any person causing or contributing to a violation of the provisions of this subtitle.
- “Right-of-way” means “right-of-way” as defined in Section 23.84A.032.
- “Roadway” means “roadway” as defined in Section 23.84A.032.

- “Roadway project” means a project located in the public right-of-way that involves the creation of a new or replacement of an existing roadway or alley. The boundary of the public right-of-way shall form the boundary between the parcel and roadway portions of a project.
- “Runoff” means the portion of rainfall or other precipitation that becomes surface flow and interflow.
- “Sanitary sewer” means a system that conveys wastewater and is not designed to convey drainage water.
- “SDCI” means the [Seattle Department of Construction and Inspections](#).
- “SDOT” means the Seattle Department of Transportation.
- “Service drain” means “service drain” as defined in Section 21.16.030.
- “Side sewer” means “side sewer” as defined in Section 21.16.030.
- “Sidewalk” means “sidewalk” as defined in Section 23.84A.036.
- “Sidewalk project” means a project for the creation of a new sidewalk or replacement of an existing sidewalk, including any associated planting strip, apron, curb ramp, curb, or gutter, and necessary roadway grading and repair. If the total new plus replaced hard surface in the roadway exceeds 10,000 square feet, the entire project is a roadway project.
- “Single-family residential project” means a project that constructs one Single-family Dwelling Unit [pursuant to Sections as defined in subsection 23.44.006.A84A.032, and any associated accessory dwelling unit](#) located in land classified as being Single-family Residential 9,600 (SF 9600), Single-family Residential 7,200 (SF 7200), or Single-family Residential 5,000 (SF 5000) pursuant to Section 23.30.010, and the total new plus replaced hard surface is less than ~~5,000~~10,000 square feet, ~~and the total new plus replaced pollution generating hard surface is less than 5,000 square feet.~~
- “Site” means the ~~lot or parcel, or portion of street, highway or other right of way, or contiguous combination thereof, where development is proposed or performed~~ [area defined by the legal boundaries of a parcel or parcels of land subject to development](#). For roadway projects, the length of the project site and the right-of-way boundaries define the site.
- “Slope” means an inclined ground surface.
- “Small lakes” means Bitter Lake, Green Lake and Haller Lake.
- “Small project” means a project with:
 1. Less than 5,000 square feet of new and replaced hard surface; and
 2. Less than ~~1~~[one](#) acre of land disturbing activities.
- “SMC” means the Seattle Municipal Code.
- “Soil” means naturally deposited non-rock earth materials.
- “Solid waste” means “solid waste” as defined in Section 21.36.016.
- “Source controls” means structures or operations that prevent contaminants from coming in contact with drainage water through physical separation or careful management of activities that are known sources of pollution.

- “SPU” means Seattle Public Utilities.
- “Standard design” is a design pre-approved by the Director for drainage and erosion control available for use at a site with pre-defined characteristics.
- [“Standard Plans and Specifications” means the City of Seattle Standard Plans and Specifications for Road, Bridge, and Municipal Construction in effect on the date of permit application.](#)
- “Storm drain” means both public storm drain and service drain.
- “Stormwater” means runoff during and following precipitation and snowmelt events, including surface runoff, drainage and interflow.
- “Stream” means a Type [2-5S, F, Np or Ns](#) water as defined in WAC 222-16-031, [or as defined in WAC 222-16-030 after state water type maps are adopted](#), and is used synonymously with “creek.”
- “Topsoil” means the weathered surface soil, including the organic layer, in which plants have most of their roots.
- “Trail” means a path of travel for recreation and/or transportation within a park, natural environment, or corridor.
- “Trail project” means a project for the creation of a new trail or replacement of an existing trail, and which does not contain pollution-generating hard surfaces.
- “Treatment facility” means a drainage control facility designed to remove pollutants from drainage water.
- “Wastewater” means “wastewater” as defined in Section 21.16.030.
- “Water Quality Standards” means Surface Water Quality Standards, Chapter 173-201A WAC, Ground Water Quality Standards, Chapter 173-200 WAC, and Sediment Management Standards, Chapter 173-204 WAC.
- “Watercourse” means the route, constructed or formed by humans or by natural processes, generally consisting of a channel with bed, banks or sides, in which surface waters flow. Watercourse includes small lakes, bogs, streams, creeks, and other receiving waters but does not include designated receiving waters.
- “Watershed” means a geographic region within which water drains into a particular river, stream, or other body of water.
- “Wetland” means a wetland designated under Section 25.09.020.
- “Wetland function” means the physical, biological, chemical, and geologic interactions among different components of the environment that occur within a wetland. Wetland functions can be grouped into three categories: functions that improve water quality; functions that change the water regime in a watershed, such as flood storage; and functions that provide habitat for plants and animals.
- “Wetland values” means wetland processes, characteristics, or attributes that are considered to benefit society.

This page intentionally left blank.

APPENDIX B

Additional Submittal Requirements

This Cover to be Replaced in PDF
with SPU-Provided Cover

Note:

Some pages in this document have been purposely skipped or blank pages inserted so that this document will copy correctly when duplexed.

Table of Contents

B-1. Preliminary Drainage Control Review Submittal Requirements for Master Use Permits	1
B-1.1. Subdivisions and Short Plats	1
B-1.1.1. Subdivisions	1
B-1.1.2. Short Plats	1
B-1.1.3. Shared Drainage Control Facilities and Systems for Subdivisions and Short Plats	2
B-1.1.4. Typical Drainage Conditions for Subdivisions and Short Plats	3
B-1.1.5. Easements for Subdivisions and Short Plats	4
B-1.1.6. Determining Minimum Requirements for Subdivisions and Short Plats	4
B-1.2. Unit Lot Subdivisions	5
B-1.3. Lot Boundary Adjustments	5
B-2. Drainage Report Format/Content Requirements	7

B-1. [Preliminary Drainage Control Review Submittal Requirements for Master Use Permits](#)

[Preliminary Drainage Control Review](#) is required for certain Master Use Permit (MUP) applications per [SMC 22.807.020.A](#) (refer to [Volume 1, Section 8.1](#)). The general submittal requirements are described in [Volume 1, Section 8.1](#). However, different types of MUPs require different levels of drainage review and detail.

[The following describes the specific submittal requirements and drainage review process for the most common types of MUP that will typically require drainage review.](#)

B-1.1. [Subdivisions and Short Plats](#)

B-1.1.1. [Subdivisions](#)

[“Full” Subdivisions per SMC 23.22 require a high level of detail for approval of Preliminary Drainage Control Review. Prior to Preliminary Plat Approval, a Preliminary Drainage Control Plan, Preliminary Drainage Report \(Report\), and all supporting documents as described in Volume 1, Section 8.1 must be submitted and approved. The Preliminary Drainage Control Plan and Report shall identify all BMPs necessary to meet the minimum requirements \(e.g., on-site stormwater management, flow control, water quality treatment, etc.\) including size and location. The level of detail required is the same as required for Standard and Comprehensive Drainage Control Review.](#)

[The Preliminary Drainage Control Plan approval does not constitute approval for construction. A Standard or Comprehensive Drainage Control Plan and Report must be submitted with a construction permit. Depending on the scope and location, required construction permit will be a Grading Permit, Building Permit, or a Seattle Department of Transportation \(SDOT\) Street Improvement Plan \(SIP\) Permit.](#)

[Subsequent construction permits in the subdivision must demonstrate with Standard or Comprehensive Drainage Control Plans that they are compliant with the intent of the approved Preliminary Drainage Control Plan.](#)

[Note: Additional requirements apply to permitting and construction of drainage control facilities and drainage systems that will be shared by multiple parcels, lots, tracts, etc., within the Subdivision. Refer to \[Section B-1.1.3\]\(#\).](#)

B-1.1.2. [Short Plats](#)

[Short Plats \(a.k.a. Short Subdivisions\) per SMC 23.24 require a similar level of detail as Full Subdivisions for approval of Preliminary Drainage Control Review.](#)

[Deferred Drainage Plans for Some Projects: The requirement for a Preliminary Drainage Control Plan and Report may be deferred until the construction permit by the Director if all of the following conditions are met:](#)

1. [The full development potential in the Short Plat, including all lots, parcels, and tracts, does not exceed the thresholds established for flow control or water quality treatment or require a mainline extension,](#)
2. [The project has an approved offsite discharge point for drainage \(e.g., public storm drain\),](#)
3. [The downstream drainage system has adequate capacity,](#)
4. [Drainage Condition #1 in *Section B-1.1.4* is placed on the first sheet of the recorded plat.](#)

[Otherwise, a Preliminary Drainage Control Plan and Report, and all supporting documents as described in *Volume 1, Section 8.1* must be submitted and approved prior to approval of the Short Plat. Depending on the scope and location, this will require a Grading Permit, Building Permit, or an SDOT SIP Permit.](#)

[Subsequent construction permits in the short subdivision must demonstrate with Standard or Comprehensive Drainage Control Plans that they are compliant with the intent of the approved Preliminary Drainage Control Plan.](#)

[Note: Additional requirements apply to permitting and construction of drainage control facilities and drainage systems that will be shared by multiple parcels, lots, tracts, etc., in the Subdivision. Refer to *Section B-1.1.3*.](#)

[B-1.1.3. Shared Drainage Control Facilities and Systems for Subdivisions and Short Plats](#)

[Drainage control facilities and systems proposed on Preliminary Drainage Control Plans that will serve multiple parcels, lots, tracts, etc., in a Subdivision or Short Plat are subject to the following code requirement.](#)

Stormwater Code Language	References
<p>SMC 22.805.010.E. Construction of drainage control facilities and drainage systems for plats.</p> <p>1. In the case of a subdivision under Chapter 23.22, drainage control facilities or drainage systems that are identified on the associated preliminary drainage control plan or the approved preliminary plat and will serve multiple proposed lots, parcels, tracts, or rights-of-way shall be constructed prior to approval of the final plat unless a bond is provided according to subsection 23.22.070.C. If a bond is provided in lieu of construction prior to approval of the final plat, the construction permit for the facilities or systems must be issued prior to issuance of any building permit for any other construction within the subdivision and construction of the facilities or systems shall be completed and final inspection approved prior to final inspection approval of any building permit for any other construction within the subdivision and prior to occupancy of any buildings, but in no event later than two years after final plat approval.</p> <p>2. In the case of a short plat under Chapter 23.24 with shared drainage control facilities or drainage systems that are identified on the preliminary drainage control plan and will serve multiple proposed lots, parcels, tracts, or rights-of-way, the following shall occur:</p>	<ul style="list-style-type: none"> • Volume 1, Section 8.1 – Preliminary Drainage Control Review • SMC 22.807.020.A – Thresholds for Drainage Control Review • SMC, Chapter 23.22 – Subdivisions • SMC, Chapter 23.24 – Short Plats

<p><u>a. The construction permit for the shared facilities or systems shall be issued prior to issuance of any building permit for any other construction within the lots, parcels, tracts, or rights-of-way served by the shared facilities or systems; and</u></p> <p><u>b. Construction of the shared facilities or systems shall be completed and final inspection approved prior to final inspection approval of any building permit for any other construction within the lots, parcels, tracts, or rights-of-way served by the shared facilities, and prior to occupancy of any buildings on these lots, parcels, or tracts.</u></p>	
---	--

In addition, shared drainage control facilities and shared service drains require a joint use and maintenance agreement (JUMA) between the parcels, lots, tracts, etc. that are served by the shared feature per the requirements of the Side Sewer Code (SMC, Section 21.16.250.C).

B-1.1.4. Typical Drainage Conditions for Subdivisions and Short Plats

Subdivisions and Short Plats will require one or more drainage conditions. The applicable drainage conditions must be placed on the first sheet of the plat that will be recorded. The following are some of the typical drainage conditions that may apply. The conditions may require modifications per the reviewer and additional drainage conditions may apply as required by the Director.

Typical Drainage Condition #1. (Required on all Subdivisions and Short Plats): The subdivision of the property will not reduce the requirements of the Seattle Stormwater Code and the Seattle Side Sewer Code. The proposed parcels within this [Subdivision/Short Plat] will meet the standards required by the higher area threshold of the entire property being subdivided rather than the standards required for each of the proposed parcels individually.

Typical Drainage Condition #2. (Required for all Subdivisions or Short Plats that require submittal of Preliminary Drainage Control Plans): Approval of the Preliminary Drainage Control Plans and Report reviewed with this Subdivision/Short Subdivision is preliminary. A Standard or Comprehensive Drainage and Wastewater Control Plan, a Construction Stormwater Control and Soil Management Plan, a Drainage Report (if triggered), and all supporting documents will be required for all future construction permits within this Subdivision/Short Subdivision to demonstrate compliance with the approved Preliminary Drainage Control Plan.

Typical Drainage Condition #3 (Required if the Preliminary Drainage Control Plan shows drainage control facilities that will serve multiple lots, parcels, or tracts within the Subdivision/Short Subdivision): The construction permit for the shared facilities or systems shown on the preliminary drainage plan shall be issued prior to issuance of the any building permit for any other construction within the lots, parcels, tracts, or rights-of-way served by the shared facilities or systems; and construction of the shared facilities or systems shall be completed and final inspection approved prior to final inspection approval of any building permit for any other construction within the lots, parcels, tracts, or rights-of-way served by the shared facilities, and prior to occupancy of any buildings of these lots, parcels, or tracts. [for full subdivisions: but in no event later than two years after final plat approval.]

Typical Drainage Condition #4 (Required if a Public Storm Drain mainline extension is required.): The public storm drain shall be extended across the full street frontage of the Subdivision/Short Plat per SMC 22.805.020.L-N unless an adjustment or exception is approved by the Director of Seattle Public Utilities per SMC 22.800.040.B or C. The permits for the public storm drain extension must be issued prior to issuance of the first building permit in the subdivision, and construction of the public storm drain must be completed before final approval of any building permit within the subdivision.

B-1.1.5. Easements for Subdivisions and Short Plats

All lots, parcels, tracts must be demonstrated to have access through easements for the proposed drainage features or conveyance systems that must cross the other lots, parcels, tracts within the subdivision or short plat and for all shared drainage facilities. Easements must be either established in the plat; or the previously recorded easement shall be shown and called out on the plat, including the King County recording number.

Note: Per SPU Policy DWW-160 "The City does not allow the use of an easement in lieu of an extension of the public storm or sewer system (i.e., public sanitary sewer [PSS], public combined sewer [PS], public storm drain [PSD]). Any adjustments or exceptions to this restriction must be authorized by the SPU General Manager/CEO or a designee." A mainline extension may be required if there are any proposed lots that abut a public street right-of-way where there is no existing public piped storm drain. Refer to the Public Drainage System Requirements Director's Rule (SPU Director's Rule DWW-210).

B-1.1.1-B-1.1.6. Determining Minimum Requirements for Subdivisions and Short Plats

The steps to determine the minimum requirements that apply to Subdivisions and Short Plats are described in *Volume 1, Chapter 2*. The project type for Subdivisions and Short Plats is parcel-based, regardless of the land use zoning; and the boundaries of the project site include the full area of the Subdivision or Short Plat. The following code section includes requirements for calculating the new plus replaced hard surface for a Subdivision or Short Plat.

<u>Stormwater Code Language</u>	<u>References</u>
<p><u>SMC 22.805.010.D</u> <u><i>In the case of a subdivision under Chapter 23.22 and short plat under Chapter 23.24, unless an adjustment pursuant to subsection 22.800.040.B is approved by the Director, for the purposes of applying the thresholds in Chapter 22.805, the hard surface coverage is the maximum lot coverage allowed per Subtitle III of Title 23, Land Use Code, plus required and proposed pedestrian and vehicular access and amenities, including driveways, walkways, plazas, and patios identified on the preliminary drainage control plan and associated preliminary site plan.</i></u></p>	<ul style="list-style-type: none"> ● <u>Volume 1, Section 2.5 – Step 5 – Calculate Land-Disturbing Activity and New Plus Replaced Hard Surface</u> ● <u>Volume 1, Section 2.6 – Calculate New Plus Replaced Pollution Generating Surface</u> ● <u>SMC 22.800.040.B – Adjustments</u> ● <u>SMC, Chapter 23.22 – Subdivisions</u> ● <u>SMC, Chapter 23.24 – Short Plats</u>

[B-1.2. Unit Lot Subdivisions](#)

[Unit Lot Subdivisions per SMC 23.22.062 and 23.24.045 typically have a building permit that is already issued or is being reviewed simultaneously with the Unit Lot Subdivision. If Standard or Comprehensive Drainage Review is already completed or in process for a Building Permit that includes all proposed development in the Unit Lot Subdivision, then the Drainage Control Plan and Drainage Report are not required to be submitted with the Unit Lot Subdivision submittal.](#)

[In the case where an application for a Building Permit that covers all development in the Unit Lot Subdivision has not been made, a Preliminary Drainage Plan and Drainage Report \(if required\), and all supporting documents must be submitted with the Unit Lot Subdivision application \(similar to Short Plats and Subdivisions\).](#)

[Easements](#)

[All unit lots must be demonstrated to have access through easements for the proposed drainage features or conveyance systems that must cross the other unit lots within the subdivision and for all shared drainage facilities. Easements must be either established in the Unit Lot Subdivision or the previously recorded easement shall be shown and called out on the Unit Lot Subdivision plat, including the King County recording number.](#)

[B-1.3. Lot Boundary Adjustments](#)

[Preliminary Drainage Review for Lot Boundary Adjustments \(LBA\) per SMC 23.28 is required. A separate Preliminary Drainage Control Plan is not required with the Master Use Permit \(MUP\) submittal if:](#)

- [1. Drainage infrastructure is accessible to each adjusted lot, and](#)
- [2. All lots that abut the public place \(i.e., street right-of-way\) have a public drainage system in their street frontage -or access directly to a receiving water.](#)

[If the adjusted lots that abut the public place \(i.e., street right-of-way\) do not have a public piped storm drain \(PSD\) in their street frontage or access directly to a receiving water, then the following LBA Drainage Adequacy Note #1 must be added to the first page of the recorded LBA plat.](#)

[LBA Drainage Adequacy Note #1](#)

[There is no available public piped storm drain \(PSD\) in the street frontage of one or more of the adjusted lots. An extension of the public storm drain may be required across the full street frontage of the adjusted lot/s if required per SMC 22.805.020.L unless an alternative is allowed by the SPU Public Drainage System Requirements Director's Rule DWW-210 \(e.g., use of a ditch, culvert, public piped combined main; curb weep or on-site infiltration for small projects\). Note: the thresholds for determining requirements include all "Closely Related Projects" as described in the SMC 22.805.010.B/Seattle Stormwater Manual Volume 1, Section 2.1.2.](#)

If an extension of a public drainage system is infeasible as determined by the Director, a Preliminary Drainage Control Plan and associated documents must be submitted to demonstrate that the potential development on each lot can be constructed with infiltration or dispersion BMPs to meet the requirements of *Volume 1, Section 4.3.2*. In this scenario, LBA Drainage Adequacy Note #2 must be added to the first page of the recorded LBA plat.

LBA Drainage Adequacy Note #2

A Preliminary Drainage Control Plan was submitted to demonstrate adequacy of drainage for potential development on the adjusted lots using [_____] (onsite infiltration or dispersion BMPs). Approval of this plan is preliminary. A Drainage and Wastewater Control Plan, a Construction Stormwater Control and Soil Management Plan, a Drainage Report, and all supporting documents will be required for all future construction permits within each of the lots and must comply with the provisions of the Preliminary Drainage Control Plan.

The level of detail required on the Preliminary Drainage Control Plan must include a Site Plan showing the proposed or potential development and the sizes and possible locations of stormwater BMPs that will manage the runoff fully on site.

Easements

All adjusted lots must be demonstrated to have legal access for the proposed drainage features or conveyance systems that must cross the other lots to reach street frontage where drainage infrastructure is located or will be extended or have access to a receiving water. Easements must be either established in the LBA; or the previously recorded easement shall be shown and called out on the LBA plat, including the King County recording number.

Note: Per SPU Policy DWW-160, "The City does not allow the use of an easement in lieu of an extension of the public storm or sewer system (i.e., public sanitary sewer [PSS], public combined sewer [PS], public storm drain [PSD]). Any adjustments or exceptions to this restriction must be authorized by the SPU General Manager/CEO or a designee." A mainline extension may be required if there are any adjusted lots that abut a public street right-of-way where there is no existing public piped storm drain (PSD). Refer to the Public Drainage System Requirements Director's Rule (SPU Director's Rule [DWW-210](#)).

B-2. [Drainage Report Format/Content Requirements](#)

Drainage Reports are a required part of many Drainage Control Plans as indicated in [Volume 1, Chapter 8](#). The following table describes the typical, required elements and recommended format for Drainage Reports. Elements that are not applicable to a particular project may be indicated as “not applicable” in the Drainage Report. Additional information that is not included in this table may be as described in [Volume 1, Section 8.4](#).

Drainage Report Section		Stormwater Manual Reference	Submittal Notes (if applicable)
1. Introduction	1.1. Project overview	Volume 1, Chapter 8	Narrative describing the project.
	1.2. Existing and Proposed Conditions		Describe the existing and proposed conditions including a summary of existing hard surface area.
2. Determining minimum requirements	2.1. Define the boundaries of the project site	Volume 1, Section 2.1	Include a vicinity map highlighting the project area
			Include a description of the drainage basin(s) where the project is located and a map highlighting the areas in the project that are in different drainage basins (if applicable).
			If there are multiple basins, include a table with area calculations and identification of drainage basins.
	2.2. Identify the type of project	Volume 1, Section 2.2	The project will be classified as a specific project type; this will determine the minimum requirements.
	2.3. Identify the receiving water and downstream conveyance	Volume 1, Section 2.3	Include at least one map that shows the existing drainage infrastructure per basin.
			Include a table or narrative describing the type of receiving water/s and types downstream conveyance systems per basin.
	2.4. Perform site assessment and planning	Volume 1, Section 2.4	The Drainage Report shall contain, at a minimum, the evaluation and conclusion of each of these items (Section 2.4.1 through 2.4.11) when applicable.
	2.4.1. Project boundaries	Volume 1, Section 7.2	
2.4.2. Setbacks			
2.4.3. Location of buildings			
2.4.4. Foundation and footing drains			
2.4.5. Soil condition assessment and infiltration feasibility analysis	Volume 1, Section 7.3; Volume 3, Section 3.2		

Drainage Report Section		Stormwater Manual Reference	Submittal Notes (if applicable)
2. Determining minimum requirements (continued)	2.4.6. Environmentally critical areas (ECAs)	Volume 1, Section 7.4	
	2.4.7. Dewatering (Temporary and Permanent)	Volume 1, Section 7.5	Identify any temporary or permanent groundwater that the project will discharge and include estimates of the discharge rates from a licensed professional.
	2.4.8. Topography	Volume 1, Section 7.6	
	2.4.9. Site Assessment	Volume 1, Section 7.7	
	2.4.10. Landscaping principles	Volume 1, Section 7.8	
	2.4.11. Site design considerations and dispersion feasibility	Volume 1, Section 7.9 Volume 3, Section 3.2	
	2.5. Calculate land disturbing activity and new plus replaced hard surface	Volume 1, Section 2.5	Provide a map highlighting the project's new plus replaced hard surface and limits of disturbance per basin. Provide a color map that identifies different types of surfaces (i.e., hard vs. pervious) and area calculations.
	2.6. Calculate new plus replace pollution generating surface	Volume 1, Section 2.6	If water quality treatment is required, provide a map highlighting the pollution generating hard and pervious areas per basin and delineate the areas tributary to each Water Quality BMP.
2.7. Determine which minimum requirements apply	Volume 1, Section 2.7	Include a summary of all minimum requirements that apply.	
3. Minimum requirements for all projects	3.1. Maintaining natural drainage patterns	Volume 1, Section 3.1	The Drainage Report shall contain, at a minimum, an evaluation and conclusion of each of these items (Section 3.1 through 3.12) when applicable.
	3.2. Discharge point	Volume 1, Section 3.2	
	3.3. Flood-prone areas	Volume 1, Section 3.3	

Drainage Report Section		Stormwater Manual Reference	Submittal Notes (if applicable)
3. Minimum requirements for all projects (continued)	3.4. Construction site stormwater pollution prevention control	Volume 1, Section 3.4; Volume 1, Chapter 8; Volume 2, Chapter 2	Include small- or large-project CSC checklist and CSC plan. A narrative is also required and a short narrative describing the selected BMPs and the results of any required calculations.
	3.5. Protect wetlands	Volume 1, Section 3.5	
	3.6. Protect streams and creeks	Volume 1, Section 3.6	
	3.7. Protect shorelines	Volume 1, Section 3.7	
	3.8. Ensure sufficient capacity	Volume 1, Section 3.8	
	3.9. Install source control BMPs	Volume 1, Section 3.9; Volume 4, Section 1.6	Include the Worksheet for Identifying Applicable Source Control BMPs (Volume 4, Table 1)
	3.10. Do not obstruct watercourses	Volume 1, Section 3.10	
	3.11. Comply with side sewer code	Volume 1, Section 3.11	Side sewers in ROW shall be shown on SIP plans but require a separate permit.
	3.12. Extension of public drainage system	Volume 1, Section 3.12	
	3.13. Public drainage system requirements	Volume 1, Section 3.13	
	3.14. Maintenance and inspection	Volume 1, Section 3.14	

Drainage Report Section		Stormwater Manual Reference	Submittal Notes (if applicable)	
4. Minimum requirements based on project type	4.1. Soil amendment	Volume 1, Section 5.1	Include site plans highlighting the area requiring soil amendment (disturbed area)	
	4.2. On-site Stormwater management	Volume 1, Section 5.2; Volume 3, Chapter 3	Include a narrative with a summary of the BMPs selected and describe any modeling required for the sizing of the BMPs or special considerations such as presettling. Describe in the infeasibility criteria for On-site Stormwater Management BMPs that were not selected. Reference the appropriate Appendix of the Report for the On-site Stormwater Management Calculator and any other required infeasibility documentation.	
	4.3. Flow control	5.3.1. Wetland protection standards	Volume 1, Section 5.3; Volume 3, Sections 3.4 and 4.1	When using hydrologic modeling software, provide conclusions for each simulation to explain how the proposed flow control BMP complied with SMC, Section 22.805.080. Include a map identifying the tributary area connected to the flow control BMP that specifies the amount of area been collected.
		5.3.2. Pre-developed forest standard		
		5.3.3. Pre-developed pasture standard		
		5.3.4. Existing condition standard		
		5.3.5. Peak control standard		
	4.4. Water quality treatment	5.4.1. Basic treatment	Volume 1, Section 5.4; Volume 3, Section 3.5	
		5.4.2. Oil treatment		
		5.4.3. Phosphorus treatment		
5.4.4. Enhanced treatment				
5. Conclusion			Describe the project and how each of the requirements were met, giving a summary of the problems and solutions proposed for this project.	

Drainage Report Section		<u>Stormwater Manual Reference</u>	<u>Submittal Notes (if applicable)</u>
Appendix A	Figures and Maps		
Appendix B	Construction Stormwater Control and Temporary Dewatering Calculations		
Appendix C	On-site Stormwater Management Workbook and any related documentation or calculations		Include the full workbook and any required documentation to justify infeasibility criteria selected (e.g., financial infeasibility criteria, rainwater demand analysis for rainwater harvesting, Geotechnical Engineering analysis and recommendations, etc.).
Appendix D	Flow Control Calculations (if required)		
Appendix E	Water Quality Calculations (if required)		
Appendix F	Landscape Management Plan (if required)		
Appendix G	Source Control Calculations (if required)		
Appendix H	Infiltration Checklist and Documentation		
Appendix I	Soil and Infiltration Investigation Documentation		Infiltration checklists and documentation. Groundwater investigation and estimated flowrate documentation. Geotechnical Report
Appendix J	Inspections and Operations and Maintenance (O&M) Requirements and schedule		

This page intentionally left blank.

APPENDIX C

On-site Stormwater List BMP Infeasibility Criteria

This Cover to be Replaced in PDF
with SPU-Provided Cover

Note:

Some pages in this document have been purposely skipped or blank pages inserted so that this document will copy correctly when duplexed.

This appendix provides infeasibility criteria for use in evaluating BMPs to meet the On-site Stormwater Management Requirement using the On-Site List approach (SMC, Section 22.805.070.D.2) to manage new and replaced hard surfaces. Refer to *Volume 1, Section 5.2.2* to determine which On-site BMPs require evaluation for a project. Evaluation is based on project type, discharge location, and other criteria. Step-by-step instructions for using the On-site List Approach are provided in *Volume 3, Section 3.3.1*.

Prior to evaluating On-site BMPs, review the site design consideration in *Volume 1, Chapter 7 – Site Assessment and Planning* to conserve natural areas, retain native vegetation, reduce impervious surfaces, and integrate stormwater controls into the existing site layout to the maximum extent feasible. The infeasibility criteria provided [in this appendix below](#) apply to BMPs if the area proposed for the BMP is the only available area for the BMP, after all reasonable efforts to regrade the site and allow for alternative placement of the BMP have been made.

When using the On-site List approach, an on-site BMP is considered infeasible if an infeasibility [criterion/criteria](#) in Tables C.1 through [C.6G.4](#) is met.

Table C.1. On-site List Infeasibility Criteria: All Dispersion and Infiltration BMPs.

BMP	On-site List Infeasibility Criteria	Additional Information from Applicant
All BMPs	<ul style="list-style-type: none"> ● Installation requires removal of an existing tree. To use this infeasibility criterion, the tree must be in good health and meet minimum size requirements: deciduous trees must have trunks at least 1.5 inches in diameter measured 6 inches above the ground, and evergreen trees must be at least 4 feet tall. In addition, the existing tree must be in an area that will be protected throughout construction. ● Where BMP installation is prohibited per Regulations for Environmentally Critical Areas (SMC Chapter 25.09). ● Where BMP installation would require pumping to a designated point of discharge, but failure of the pump may destabilize a steep slope. ● Where unable to maintain a desired access of 36 inches in a required building setback from a property line, except when using the Soil Amendment BMP (Volume 3, Section 5.1). ● Where unable to maintain clearance for required ingress, egress, or ADA pathways. ● Where BMP installation would require a pump when a pump is not already required to provide site storm drainage. Requiring a pump as the result of using the Rainwater Harvesting BMP does not make this BMP infeasible. 	

Table C.1 (continued). On-site List Infeasibility Criteria: All Dispersion and Infiltration BMPs.

BMP	On-site List Infeasibility Criteria	Additional Information from Applicant
All Dispersion BMPs	<ul style="list-style-type: none"> ● A licensed professional (as defined in <i>Appendix D, Section D-1</i>) recommends dispersion not be used anywhere within project site due to reasonable concerns of erosion, slope failure, or flooding (requires a signed and stamped written determination based on site-specific conditions from a licensed professional). ● The dispersion flow path area does not provide positive drainage. ● The dispersion flowpath area is within a landslide-prone area (SMC, Section 25.09.080). ● The dispersion flowpath area is within 100 feet of a contaminated site or landfill (active or closed). ● The dispersion flowpath area is in a steep slope area (SMC, Section 25.09.020) or within a setback to a steep slope area (calculated as 10 times the height of the steep slope to a 500-foot maximum setback). ● The dispersion flowpath area is within 10 feet of a proposed or existing septic system or drainfield. 	
All Infiltration BMPs	<p>The following criteria each establish that the BMP is infeasible but only if based on an evaluation of site-specific conditions and documented within a signed and stamped written determination from a licensed professional (as defined in <i>Appendix D, Section D-1</i>):</p> <ul style="list-style-type: none"> ● Infiltration is not recommended due to reasonable concerns about erosion, slope failure, or flooding. ● The area available for siting would threaten the safety or reliability of pre-existing underground utilities, pre-existing underground storage tanks, pre-existing structures, or pre-existing road or parking lot surfaces or subgrades. ● The area available for siting would threaten shoreline structures such as bulkheads. <p>The following criteria each establish that the BMP is infeasible, without further justification, though some criteria evaluation require professional services:</p> <ul style="list-style-type: none"> ● Evaluation of infiltration is not required per the “Infiltration Investigation Map”. ● The area available for siting does not allow for overflow conveyance to an approved point of discharge per Volume 3, Section 4.3.2. ● The area available for siting is within a steep slope area or land-slide prone area (or setback) (refer to <i>Volume 3, Section 3.2</i>). ● The area available for siting does not meet the minimum horizontal setback requirements (refer to <i>Volume 3, Section 3.2</i>). ● The area available for siting does not meet the minimum vertical setback requirements (refer to <i>Volume 3, Section 3.2</i>, and <i>Appendix D</i>). ● Infiltration is restricted due to contaminated soil or groundwater (refer to <i>Volume 3, Section 3.2</i>). 	

Table C.2. On-site List Infeasibility [Criteria](#): Category 1 BMPs.

BMP	On-site List Infeasibility Criteria	Additional Information from Applicant
Full Dispersion	<ul style="list-style-type: none"> ● One or more of the infeasibility criteria for “All BMPs” or “All Dispersion BMPs” (Table C.1) apply. ● The site has less than a 65 to 10 ratio of the native vegetation area to the impervious area. ● The minimum native vegetation flowpath length is less than 100 feet. 	
Infiltration Trenches	<ul style="list-style-type: none"> ● One or more of the infeasibility criteria for “All BMPs” or “All Infiltration BMPs” (Table C.1) apply. ● Field testing indicates potential infiltration trench site(s) have a measured underlying soil infiltration rate less than 5 inches per hour (<i>Volume 3, Section 5.4.2</i>). ● Where the site cannot be reasonably designed to locate a catch basin between the infiltration trench and point of connection to the public system. 	
Drywells	<ul style="list-style-type: none"> ● One or more of the infeasibility criteria for “All BMPs” or “All Infiltration BMPs” (Table C.1) apply. ● Field testing indicates potential drywell site(s) have a measured underlying soil infiltration rate less than 5 inches per hour (<i>Volume 3, Section 5.4.3</i>). ● Where the site cannot be reasonably designed to locate a catch basin between the drywell and point of connection to the public system. 	

Table C.3. On-site List Infeasibility Criteria: Category 2 BMPs.^a

BMP	On-site List Infeasibility Criteria	Additional Information from Applicant
Rain Gardens	<ul style="list-style-type: none"> ● One or more of the infeasibility criteria for “All BMPs” or “All Infiltration BMPs” (Table C.1) apply. ● In the right-of-way, the longitudinal road slope exceeds 4 percent. ● The rain garden would have a linear geometry with a longitudinal slope greater than 8 percent. ● The minimum bottom width of the rain garden (12-inch average) cannot be met due to, but not limited to: encroachment within the critical root zone of an existing tree(s) or minimum setbacks to structures, utilities, or property lines. ● The infiltration area is within the minimum vertical or horizontal clearance from utilities, according to clearances required by the utility owner. ● Field testing indicates soils have a measured underlying soil infiltration rate less than 0.3 inches per hour. 	
Infiltrating Bioretention Facilities	<ul style="list-style-type: none"> ● One or more of the infeasibility criteria for “All BMPs” or “All Infiltration BMPs” (Table C.1) apply. ● The infiltrating bioretention facility would have a linear geometry with a longitudinal slope greater than 8 percent. ● The minimum bottom width of the infiltrating bioretention facility (2 feet for facilities with vertical sides and 18 inch average for facilities with sloped sides) cannot be met due to, but not limited to: encroachment within the critical root zone of an existing tree(s) or minimum setbacks to structures, utilities, or property lines. ● The infiltration area is within the minimum vertical and horizontal clearance from utilities, according to clearances required by the utility owner. ● Field testing indicates soils have a measured underlying soil infiltration rate less than 0.3 inches per hour. ● Field testing indicates soils have a measured underlying soil infiltration rate less than 0.6 inches per hour and an underdrain cannot be installed per the design criteria. ● The facility with an underdrain would route underdrained water to a nutrient-critical receiving water. ● In the right-of-way, installation requires a vertical walled facility. 	
Rainwater Harvesting	<ul style="list-style-type: none"> ● One or more of the infeasibility criteria for “All BMPs” (Table C.1) apply. ● Project lacks non-pollution-generating roof from which to harvest rainwater. ● Non-potable water demand is insufficient to meet the On-site Performance Standard per modeling conducted in accordance with <i>Volume 3, Section 5.5.1.6</i>. ● Installation is not economically feasible based on reasonable consideration of financial cost (e.g., roof area is less than 20,000 sf or the ratio of roof area to average daily rainwater demand is less than 10,000 square feet/gpm) (refer to <i>Appendix H</i>). Documentation is required. 	

Table C.3 (continued). On-site List Infeasibility Criteria: Category 2 BMPs.^a

BMP	On-site List Infeasibility Criteria	Additional Information from Applicant
Permeable Pavement Facilities	<ul style="list-style-type: none"> ● One or more of the infeasibility criteria for “All BMPs” or “All Infiltration BMPs” (Table C.1) apply. <p>The following criteria each establish that the BMP is infeasible but only if based on an evaluation of site-specific conditions and a written recommendation from a licensed professional (as defined in <i>Appendix D, Section D-1</i>):</p> <ul style="list-style-type: none"> ● Infiltrating or ponding water below pavement area would compromise adjacent pavements. ● Fill soils are used that can become unstable when saturated. ● The permeable pavement design does not provide sufficient strength to support heavy loads in areas with “industrial activity” as identified in 40 CFR 122.26(b)(14). <p>The following criteria each establish that the BMP is infeasible, without further justification, though some criteria require professional services:</p> <ul style="list-style-type: none"> ● The subgrade slope exceeds 6 percent after reasonable efforts to grade. ● The permeable pavement wearing course slope exceeds 6 percent after reasonable efforts to grade. ● For projects in the right-of-way, the permeable pavement surface area would be less than 2,000 square feet of contiguous pavement and the project discharges to: <ul style="list-style-type: none"> ○ A designated receiving water body, or ○ A combined system, or ○ A capacity constrained system which does not drain to a creek wetland or small lake. ● The anticipated mature tree spread (based on tree species) would overhang more than 50 percent of permeable pavement area. ● The pavement is over a structure, such as, but not limited to: parking garages, box culverts, and bridges. ● The pavement is subject to long-term excessive sediment deposition (e.g., construction and landscaping material yards). ● Underlying soils are unsuitable for supporting traffic loads when saturated (e.g., a residential access road has a California Bearing Ratio of 5 percent or less). ● Field testing indicates soils have a measured underlying soil infiltration rate less than 0.3 inches per hour. ● Pavement is replacing an existing pollution-generating hard surface in the right-of-way. ● The street type is classified as arterial or collector rather than local access. Refer to RCW 35.78.010, RCW 36.86.070, and RCW 47.05.021. Note: This infeasibility criterion does not extend to sidewalks and other non-traffic bearing surfaces associated with the collector or arterial. 	

Table C.3 (continued). On-site List Infeasibility Criteria: Category 2 BMPs.^a

BMP	On-site List Infeasibility Criteria	Additional Information from Applicant
Permeable Pavement Facilities (continued)	<ul style="list-style-type: none"> ● Streets that receive more than very low traffic volumes, and areas having more than very low truck traffic. Streets with a projected average daily traffic volume of 400 vehicles or less are very low volume roads (AASHTO, 2001) (U.S. Dept. of Transportation, 2013). Areas with very low truck traffic volumes are streets and other areas not subject to through truck traffic but may receive up to weekly use by utility trucks (e.g., garbage, recycling), daily school bus use, and multiple daily use by pick-up trucks, mail/parcel delivery trucks, and maintenance vehicles. Note: This infeasibility criterion does not extend to sidewalks and other non-traffic bearing surfaces. ● The pavement area is defined as a “high use site” in SMC, Section 22.801.090. ● In areas with “industrial activity” as identified in 40 CFR 122.26(b)(14). ● Where the risk of concentrated pollutant spills is more likely, including, but not limited to, gas stations, truck stops, and industrial chemical storage sites. ● In areas where routine, heavy roadway applications of sand occur in frequent snow zones to maintain traction during weeks of snow and ice accumulation, including sidewalks within 7 feet of driving lanes with sand application. ● Where runoff from unstabilized erodible areas would occur without presettling. ● The areas contributing runoff to the permeable pavement facilities exceed the maximum run-on limits: <ul style="list-style-type: none"> ○ Pollution-generating impervious surfaces (e.g., roadways, parking lots) exceed the maximum run-on area ratio of 2:1 ○ Non-pollution generating impervious surfaces (e.g., roofs, sidewalks) and stabilized pervious surfaces exceed the maximum run-on area ratio of 5:1 ● Where the Director has determined that permeable pavement in active zones of a skate park, bike park, or sport court violates safety standards 	

Table C.3 (continued). On-site List Infeasibility Criteria: Category 2 BMPs.^a

BMP	On-site List Infeasibility Criteria	Additional Information from Applicant																		
Permeable Pavement Surfaces	<ul style="list-style-type: none"> ● One or more of the infeasibility criteria provided for permeable pavement facilities apply. (Note, however, that for permeable pavement surfaces, the infeasibility criteria for “All Infiltration BMPs” are not applicable). ● Field testing indicates soils have a measured underlying soil infiltration rate less than 0.3 inches per hour (Note: field infiltration tests are not required for permeable pavement surfaces, but must be used to demonstrate infeasibility). ● The site is a contaminated site or abandoned landfill. ● Installation is within 10 feet of an underground petroleum, chemical, or liquid hazardous waste storage tank or connecting underground pipes. (Applicable to tanks used to store petroleum products, chemicals, or liquid hazardous wastes). ● Run-on from an adjacent impervious area is greater than 10 percent of the permeable pavement surface area. ● A licensed professional (as defined in <i>Appendix D, Section D-1</i>) recommends permeable pavement not be used anywhere within the project site due to reasonable concerns of erosion, slope failure, or flooding (requires a signed and stamped written determination based on site-specific conditions from a licensed professional). ● Where the Director has determined that permeable pavement in active zones of a skate park, bike park, or sport court violates safety standards. ● Based on subsurface investigation,^a groundwater or hydraulically-restrictive layer is too shallow per the following Minimum Vertical Separation table. <table border="1" data-bbox="381 1234 1187 1608" style="width: 100%; border-collapse: collapse; text-align: center;"> <thead> <tr> <th colspan="4" style="padding: 5px;">Permeable Pavement Surfaces</th> </tr> <tr> <th rowspan="2" style="padding: 5px;">Season</th> <th rowspan="2" style="padding: 5px;">Minimum Investigation Depth (ft)^b</th> <th colspan="2" style="padding: 5px;">Minimum Vertical Separation, ft^a</th> </tr> <tr> <th style="padding: 5px;">Ground-water</th> <th style="padding: 5px;">Hydraulically -Restrictive Layer</th> </tr> </thead> <tbody> <tr> <td style="padding: 5px;">Wet Season (November – March)</td> <td style="padding: 5px;">2</td> <td style="padding: 5px;">1</td> <td style="padding: 5px;">1</td> </tr> <tr> <td style="padding: 5px;">Dry Season (April – October)</td> <td style="padding: 5px;">3</td> <td style="padding: 5px;">2</td> <td style="padding: 5px;">1</td> </tr> </tbody> </table> <p style="font-size: small; margin-top: 10px;"> ^a Subsurface investigation is not required for permeable pavement surfaces, but subsurface investigation must be performed to demonstrate infeasibility due to lack of vertical separation. ^b The minimum investigation depth and vertical separation shall be measured from the bottom of the BMP. The bottom of the BMP is defined as the deepest portion of proposed BMP where water is expected to move into the underlying soil (i.e., at the aggregate subbase or Water Quality Treatment Course [if required]). </p>	Permeable Pavement Surfaces				Season	Minimum Investigation Depth (ft)^b	Minimum Vertical Separation, ft^a		Ground-water	Hydraulically -Restrictive Layer	Wet Season (November – March)	2	1	1	Dry Season (April – October)	3	2	1	
Permeable Pavement Surfaces																				
Season	Minimum Investigation Depth (ft)^b	Minimum Vertical Separation, ft^a																		
		Ground-water	Hydraulically -Restrictive Layer																	
Wet Season (November – March)	2	1	1																	
Dry Season (April – October)	3	2	1																	

Table C.3 (continued). On-site List Infeasibility Criteria: Category 2 BMPs.^a

BMP	On-site List Infeasibility Criteria	Additional Information from Applicant
Sidewalk/Trail Compost-Amended Strip	<ul style="list-style-type: none"> ● One or more of the infeasibility criteria for “All BMPs,” “All Dispersion BMPs,” or “All Infiltration BMPs” (Table C.1) apply. ● The flowpath downstream of the Sidewalk/Trail Compost-Amended Strip is within 10 feet of a proposed or existing septic system or drainfield, as measured from the toe of the Sidewalk/Trail Compost-Amended Strip slope. ● The sidewalk or trail to be dispersed exceeds a lateral slope of 5 percent or a longitudinal slope of 8 percent. ● The sidewalk or trail to be dispersed has a lateral slope of less than 1 percent. ● Field testing indicates underlying soils have a design soil infiltration rate less than 0.15 inch per hour. Note that field infiltration tests are not required for the Sidewalk/Trail Compost-Amended Strip, but must be used to demonstrate infeasibility. ● The minimum Sidewalk/Trail Compost-Amended Strip design criteria cannot be met. 	

^a [Category references Parcel-based Project list. Refer to SMC, Section 22.805.070.D and Volume 1 Section 5.2.2 for categories relevant to other types of projects.](#)

Table C.4. On-site List Infeasibility Criteria: Category 3 BMPs.^a

BMP	On-site List Infeasibility Criteria	Additional Information from Applicant
Sheet Flow Dispersion	<ul style="list-style-type: none"> ● One or more of the infeasibility criteria for “All BMPs” or “All Dispersion BMPs” (Table C.1) apply. ● The area to be dispersed (e.g., driveway, patio) exceeds a slope of 15 percent. ● The minimum vegetated flow path for sheet flow dispersion cannot be met. Note: A 10-foot flowpath is required to disperse runoff from a contributing flow length of up to 20 feet. An additional 10 feet of flow path is required for each additional 20 feet of contributing flow path or fraction thereof. Refer to <i>Volume 3, Figure 5.5</i>. ● The flowpath does not meet the minimum horizontal setback requirements to property lines, structures and other flowpaths (refer to <i>Volume 3, Section 5.3.5</i>). 	
Concentrated Flow Dispersion	<ul style="list-style-type: none"> ● One or more of the infeasibility criteria for “All BMPs” or “All Dispersion BMPs” (Table C.1) apply. ● There are no concentrated flows to disperse. ● The minimum dispersion trench length of 10 feet cannot be met. ● The vegetated flow path for the dispersion trench is less than 25 feet ● The vegetated flow path for a rock pad is less than 50 feet. ● Greater than 700 square feet of surface area drains to the BMP. ● The flowpath does not meet the minimum horizontal setback requirements to property lines, structures and other flowpaths (refer to <i>Volume 3, Section 5.3.6</i>). 	
Splashblock Downspout Dispersion	<ul style="list-style-type: none"> ● One or more of the infeasibility criteria for “All BMPs” or “All Dispersion BMPs” (Table C.1) apply. ● There are no downspouts. ● The vegetated flowpath is less than 50 feet. ● Greater than 700 square feet of surface area drains to the BMP. ● The flowpath does not meet the minimum horizontal setback requirements to property lines, structures and other flowpaths (refer to <i>Volume 3, Section 5.3.3</i>). 	
Trench Downspout Dispersion	<ul style="list-style-type: none"> ● One or more of the infeasibility criteria for “All BMPs”-or “All Dispersion BMPs” (Table C.1) apply. ● There are no downspouts. ● The minimum dispersion trench length of 10 feet for every 700 square feet of drainage area cannot be met. ● The vegetated flowpath is less than 25 feet. ● The flowpath is within the setbacks to property lines, structures and other flowpaths (refer to <i>Volume 3, Section 5.3.4</i>). 	

^a [Category references Single Family Residential-based Project list. Refer to SMC, Section 22.805.070.D and Volume 1 Section 5.2.2 for categories relevant to other types of projects.](#)

Table C.5. On-site List Infeasibility Criteria: Category 43 BMPs.^a

BMP	On-site List Infeasibility Criteria	Additional Information from Applicant
Non-Infiltrating Bioretention	<ul style="list-style-type: none"> ● One or more of the infeasibility criteria for “All BMPs” (Table C.1) apply. ● The minimum bottom width of the non-infiltrating bioretention facility (2 feet) cannot be met due to, but not limited to: encroachment within the critical root zone of an existing tree(s), minimum setbacks to structures/utilities, or project limits/planting strip too small. ● Minimum vertical and horizontal clearances from utilities are unachievable as required by utility owner. ● The facility would route underdrained water to a nutrient-critical receiving water. ● The area available for siting is within a setback equal to the height of the slope to a maximum of 50 feet from the top of steep slope and known landslide area. ● The BMP would be located on a structure or roof that cannot provide sufficient structural support for the BMP without reasonable effort to increase the strength of the roof design. ● Less than 1 foot between the liner and seasonal high groundwater elevation. 	
Rainwater Harvesting	See On-site List Infeasibility Criteria in Table C.3.	
Vegetated Roof Systems	<ul style="list-style-type: none"> ● One or more of the infeasibility criteria for “All BMPs” (Table C.1) apply. ● Project does not include a roof. ● Roof design has a slope less than 1 degree (0.2:12) or greater than 10 degrees (2:12). ● Installation is not economically feasible based on reasonable consideration of financial cost (refer to <i>Appendix H</i>). Documentation is required. ● The portion of the roof is an amenity area subject to pedestrian use (e.g., balcony, patio, walkway, pet runs, etc.). ● The portion of the roof is required for HVAC equipment and/or maintenance access ways (e.g., window washing, HVAC maintenance, etc.). ● The portion of the roof is completely covered with solar panels. 	
Single Family Residential (SFR) Cistern	<ul style="list-style-type: none"> ● Project does not include non-pollution generating surfaces. ● The SFR cistern would be within restricted setbacks 	

^a [Category references Single Family Residential-based Project list. Refer to SMC, Section 22.805.070.D and Volume 1 Section 5.2.2 for categories relevant to other types of projects.](#)

Table ~~C.6C.5~~ C.6C.5. On-site List Infeasibility Criteria: Category ~~4-5~~ 4-5 BMPs.^a

BMP	On-site List Infeasibility Criteria	Additional Information from Applicant
Perforated Stub-out Connections	<ul style="list-style-type: none"> ● One or more of the infeasibility criteria for “All BMPs” or “All Infiltration BMPs” (Table C.1) apply. ● The location for the perforated pipe portion of the system is under impervious or heavily compacted (e.g., driveways and parking areas) surfaces. ● The minimum perforated stub-out length of 10 feet per 5,000 square feet of contributing roof area cannot be met. ● Where the site cannot be reasonably designed to locate a catch basin between the perforated stub-out and point of connection to the public system. 	
Newly Planted Trees	<ul style="list-style-type: none"> ● The mature height, size, and/or rooting depth is not compatible with Medium and Large trees listed in the reference materials posted on SDCI’s websitecurrent Seattle Master Tree List. 	
Single Family Residential (SFR) Cistern	<ul style="list-style-type: none"> ● One or more of the infeasibility criteria for “All BMPs” (Table C.1) apply. ● Project does not include non-pollution generating surfaces. ● The SFR cistern would be within restricted setbacks. 	

^a [Category references Single Family Residential-based Project list. Refer to SMC, Section 22.805.070.D and Volume 1 Section 5.2.2 for categories relevant to other types of projects.](#)

This page intentionally left blank.

APPENDIX D

Subsurface Investigation and Infiltration Testing for Infiltration BMPs

This Cover to be Replaced in PDF
with SPU-Provided Cover

Note:

Some pages in this document have been purposely skipped or blank pages inserted so that this document will copy correctly when duplexed.

Table of Contents

- D-1. Roles and Responsibilities of Licensed Professionals 1
- D-2. Subsurface Investigation 2
 - D-2.1. Description 2
 - D-2.2. General Subsurface Investigation Requirements 2
 - D-2.2.1. Subsurface Investigation Locations 2
 - D-2.2.2. Subsurface Investigation Timing 2
 - D-2.2.3. Alternatives to Subsurface Investigation 2
 - D-2.2.4. Investigation Depth and Vertical Separation Requirements 3
 - D-2.2.5. Subsurface Report 3
 - D-2.3. Simple Subsurface Investigation 3
 - D-2.4. Standard Subsurface Investigation 4
 - D-2.5. Comprehensive Subsurface Investigation 5
 - D-2.6. Deep Infiltration Subsurface Investigation 7
- D-3. Infiltration Tests 7
 - D-3.1. Description 7
 - D-3.2. Simple Infiltration Test 8
 - D-3.3. Small Pilot Infiltration Test (Small PIT) 9
 - D-3.4. Large Pilot Infiltration Test (Large PIT) 10
 - D-3.5. Deep Infiltration Test 11
- D-4. Infiltration Rate Correction Factor 12
 - D-4.1. Simple Infiltration Test 12
 - D-4.2. Small and Large PITs 12
- D-5. Groundwater Monitoring 13
- D-6. Characterization of Infiltration Receptor 14
- D-7. Groundwater Mounding and Seepage Analysis 14
 - D-7.1. Data Requirements 15
 - D-7.2. Analysis Procedures 16
- D-8. Acceptance Testing 17
 - D-8.1. Acceptance Criteria Definitions 17
 - D-8.2. Acceptance Testing Requirements 18
 - D-8.3. Acceptance Testing Plan 19
 - D-8.4. Acceptance Testing Submittal 20

D-1. Roles and Responsibilities of Licensed Professionals

This appendix provides the minimum investigation requirements for infiltration best management practices (BMPs). This information does not preclude the use of professional judgment to evaluate and manage risk associated with design, construction, and operation of infiltration BMPs.

When a licensed professional is required to perform a subsurface investigations and/or infiltration testing, that professional shall be an engineer, engineering geologist, geologist, hydrogeologist, or soil scientist licensed by the State of Washington who has experience in infiltration and or groundwater testing and infiltration BMP design, except in the following cases:

- The licensed professional shall be either a geotechnical engineer or hydrogeologist licensed by the State of Washington when:
 - A Comprehensive Subsurface Investigation is required.
 - A correction factor for a Comprehensive Subsurface Investigation is required to be determined.
 - Infiltration is proposed in an Environmentally Critical Area (ECA) steep slope or landslide-prone areas or within a setback of 10 times the height of the steep slope area to a maximum of 500 feet above a steep slope area.
- The licensed professional shall be a hydrogeologist licensed in the State of Washington when:
 - Runoff from 5,000 square feet or more of impervious surface area will be infiltrated within 500 feet up-gradient or 100 feet down-gradient of a contaminated site or landfill (active or closed).
 - Groundwater mounding and/or seepage analysis is required.
 - A deep subsurface infiltration test is required.

Acceptance testing shall be performed by a licensed professional from the same category as was required for the design investigations.

Recommendations that deviate from the minimum investigation requirements specified in this appendix shall be contained in a stamped and signed letter from a State of Washington licensed professional engineer, engineering geologist, geologist, or hydrogeologist, herein referred to as licensed professional, who has experience in infiltration and groundwater testing and infiltration facility design, and must provide rationale and specific data supporting their professional judgment. For more information on the role of the geotechnical engineer or hydrogeologist licensed professional, refer to City of Seattle Director's Rule 5-201618-2011, *General Duties and Responsibilities of Geotechnical Engineers*.

D-2. Subsurface Investigation

D-2.1. Description

Subsurface investigations consist of any type of excavation that allows for the collection of soil samples and the observation of subsurface materials and groundwater conditions, including hand-auger holes, test pits, and drilled boreholes.

This section includes general subsurface investigation requirements followed by specific information regarding four types of subsurface investigations:

- Simple subsurface investigation
- Standard subsurface investigation
- Comprehensive subsurface investigation
- Deep infiltration subsurface investigation

D-2.2. General Subsurface Investigation Requirements

This section includes requirements for subsurface investigation locations, timing, alternatives, investigation depth and vertical separation requirements, and subsurface reports.

D-2.2.1. Subsurface Investigation Locations

For Single-Family Residential (SFR) and Parcel-based projects, the site is defined as the project area. For Trail, Sidewalk, or Roadway projects, the site is defined by one intersection to the other and blocks may vary in length. In many cases, subsurface investigations should be performed at the site of the infiltration [facility-BMP](#) or as close as possible, but no more than 50 feet away, to obtain relevant subsurface information. Subsurface investigations can be conducted at the same location as the infiltration tests ([refer to Section D-3](#)).

D-2.2.2. Subsurface Investigation Timing

Subsurface investigations should be performed in the wet season (November through March) if possible, when soils may contain a higher water content and groundwater levels are typically higher. Refer to *Sections D-2.3 through D-2.5* for wet season and dry season requirements for the different types of subsurface investigations.

D-2.2.3. Alternatives to Subsurface Investigation

In some cases, available data and the licensed professional's interpretation of subsurface material characteristics can be used to demonstrate that infiltration is infeasible on a site and precludes the need for all of the subsurface investigation or infiltration testing. Examples of these instances include, but are not limited to:

- Groundwater monitoring data that meets the requirements of the groundwater monitoring section ([refer to Section D-5](#)), at the site of the proposed [facility-BMP](#) showing groundwater elevations not meeting the vertical separation requirements ([refer to Section D-2.2.4](#)).

- Identification by the licensed professional of hydraulically-restrictive materials beneath the proposed [facility-BMP](#) and within the vertical separation requirements ([refer to Section D-2.2.4](#)).
- To support these instances, the licensed professional must submit a stamped and signed letter that provides rationale and specific data supporting their professional judgment for each area deemed infeasible for infiltration.

D-2.2.4. Investigation Depth and Vertical Separation Requirements

Investigation depth is measured below the bottom of the proposed infiltration BMP. The bottom of the infiltration [facility-BMP](#) is defined as the deepest portion of proposed [facility BMP](#) where infiltrating water is expected to move into the underlying soil.

The vertical separation requirements depend upon the type of subsurface investigation required and the seasonal timing of the geotechnical exploration conducted to evaluate clearance and are typically one foot less than the minimum investigation depths summarized in *Sections D-2.3 through D-2.5*. If groundwater or a hydraulically-restrictive material is encountered within the vertical separation depth, then no further investigation is required.

Examples of materials that may be interpreted as hydraulically-restrictive include:

- Glacially consolidated soils that have greater than 50 percent fines
- Glacially unconsolidated soils that have greater than 70 percent fines
- Bedrock

D-2.2.5. Subsurface Report

Projects that are required to perform subsurface investigations per *Volume 3, Section 3.2*, shall prepare a report documenting results of the subsurface investigations described in *Sections D-2.3 through D-2.6* and infiltration tests described in *Section D-3*.

D-2.3. Simple Subsurface Investigation

This section summarizes the minimum requirements of a Simple Subsurface Investigation. Refer to Table 3.1 in *Volume 3, Section 3.2* to determine the minimum subsurface investigation requirements for a project. ~~The Simple Subsurface Investigation is conducted approximately 5 feet from the test hole.~~

A simple subsurface investigation report can be used to document the investigation and testing results. This report ~~shall~~[should](#) include the following, [as applicable](#):

- Map of investigation and testing location
- Soil characteristics
- Depth to groundwater (if encountered)
- Results of subsurface investigations as required in Table 3.1 of Volume 3, Section 3.2 and evaluation of vertical separation results.

Simple Subsurface Investigation Elements			
<u>Minimum Investigation Depth and Vertical Separation Requirements</u>			
All BMPs			
Season	Minimum Investigation Depth (ft)^a	Minimum Vertical Separation, ft ^a	
		Groundwater	Hydraulically-Restrictive Layer
Wet Season (November – March)	2	1	1
Dry Season (April – October)	3	2	1
<u>Soil Characteristics</u>			
Type and texture of soil			

^a ~~The minimum investigation depth and vertical separation shall be measured from the bottom of the facility.~~ The bottom of the facility-BMP is defined as the deepest portion of proposed facility-BMP where infiltrating water is expected to move into the underlying soil.

D-2.4. Standard Subsurface Investigation

This section summarizes the minimum requirements of a Standard Subsurface Investigation. Refer to Table 3.1 in *Volume 3, Section 3.2* to determine the minimum subsurface investigation requirements for a project.

A standard subsurface investigation report shall be used to document the investigation and testing results. This report shall include the following, as applicable:

- Map of investigation and testing location
- Soil characteristics for each soil and/or rock unit encountered
- Depth to groundwater (if encountered)
- Detailed logs for each investigation
- Results of subsurface investigations as required in Table 3.1 of *Volume 3, Section 3.2* and evaluation of vertical separation results.

If a small pilot infiltration test (PIT) is required, the report shall be signed and stamped by a licensed professional.

Standard Subsurface Investigation Elements			
<u>Minimum Investigation Depth and Vertical Separation Requirements</u>			
Season	Minimum Investigation Depth (ft) ^a	Minimum Vertical Separation (ft) ^a	
		Groundwater	Hydraulically-Restrictive Layer
Infiltration Basins			
Wet Season (November – March)	6	5	5
Dry Season (April – October)	7	6	5
All Other Infiltration BMPs			
Wet Season (November – March)	2	1	1
Dry Season (April – October)	4	3	1
<u>Characterization for each soil and/or rock unit (strata with the same texture, color/mottling, density, and type)</u>			
<ul style="list-style-type: none"> ● USCS classification or textural class ● Material texture, color/mottling, density and type ● Relative moisture content ● Grain size distribution, including fines content determination ● Presence of stratification or layering ● Presence of groundwater ● Iron oxide staining or mottling that may provide an indication of high water level ● Cation exchange capacity (refer to <i>Volume 3, Section 4.5.2</i>) 			
<u>Detailed logs for each investigation</u>			
<ul style="list-style-type: none"> ● Map showing the location of the test pits or borings ● Depth of investigations ● Investigation methods (hand augers, test pits, or drilled borings), material descriptions ● Depth to water (if present) ● Presence of stratification ● Existing boring or groundwater information 			
<p>The report shall document how the information collected relates to the infiltration feasibility of the site based on the setbacks provided in <i>Volume 3, Section 3.2</i> and this appendix. If more than 2,000 sf of the site infiltration will occur within a single facility-BMP, the Standard Subsurface Investigation report shall be prepared by a licensed professional.</p>			

^a ~~The minimum investigation depth and vertical separation shall be measured from the bottom of the facility.~~ The bottom of the [facility-BMP](#) is defined as the deepest portion of proposed [facility-BMP](#) where infiltrating water is expected to move into the underlying soil. For Small PITs, sampling of distinct materials below the bottom of the [facility-BMP](#) and within the vertical separation depth is required. Beyond this depth, samples should be collected every 2.5 feet.

D-2.5. Comprehensive Subsurface Investigation

This section summarizes the minimum requirements of a Comprehensive Subsurface Investigation. Refer to Table 3.1 in *Volume 3, Section 3.2* to determine the minimum subsurface investigation requirements for a project. The comprehensive subsurface investigation report shall be prepared, [signed and stamped](#) by a [licensed professional geotechnical engineer or hydrogeologist](#).

A comprehensive subsurface investigation report shall be used to document the investigation and testing results. This report shall include the following, as applicable:

- Map of investigation and testing location
- Soil characteristics for each soil and/or rock unit encountered
- Depth to groundwater (if encountered)
- Detailed logs for each investigation
- Results of subsurface investigations as required in Table 3.1 of Volume 3, Section 3.2 and evaluation of vertical separation results.

Comprehensive Subsurface Investigation Elements			
<u>Minimum Investigation Depth and Vertical Separation Requirements</u>			
Season	Minimum Investigation Depth (ft)^{a,b}	Minimum Vertical Separation (ft)	
		Groundwater	Hydraulically-Restrictive Layer
Infiltration Basins			
Wet Season (November – March)	6	5	5
Dry Season (April – October)	10	8	5
Permeable Pavement Facilities			
Wet Season (November – March)	2	1	1
Dry Season (April – October)	4	3	1
<u>Infiltrating Bioretention with Underdrain</u>			
<u>Wet Season (November – March)</u>	<u>2</u>	<u>1</u>	<u>1</u>
<u>Dry Season (April – October)</u>	<u>10</u>	<u>8</u>	<u>1</u>
<u>Infiltrating Bioretention without Underdrain and All Other Infiltration BMPs</u>			
Wet Season (November – March)	4	3	3
Dry Season (April – October)	10	8	3
<u>Characterization for each soil and/or rock unit (strata with the same texture, color/mottling, density, and type)</u>			
Same as Standard Subsurface Investigation (<i>Section D-2.4</i>)			
<u>Detailed logs for each investigation</u>			
Same as Standard Subsurface Investigation (<i>Section D-2.4</i>)			

^a The minimum investigation depth and vertical separation shall be measured from the bottom of the facility. The bottom of the facility BMP is defined as the deepest portion of proposed facility BMP where infiltrating water is expected to move into the underlying soil. For Small PITs, sampling of distinct materials below the bottom of the facility BMP and within the vertical separation depth is required. Beyond this depth, samples should be collected every 2.5 feet.

^b If the bottom of the facility BMP is not known, the minimum investigation depth shall be 16 feet below grade. Investigations that will also serve as groundwater monitoring wells shall not be less than 20 feet below the bottom of proposed facility BMP and the criteria for vertical separation to groundwater or hydraulically-restrictive materials listed above shall apply.

D-2.6. Deep Infiltration Subsurface Investigation

This section summarizes the minimum requirements of a Deep Infiltration Subsurface Investigation. Refer to Table 3.2 in *Volume 3, Section 3.2*, to determine the minimum subsurface investigation requirements for a project. The deep infiltration subsurface investigation report shall be prepared by a licensed [professional geotechnical engineer or hydrogeologist](#).

Deep Infiltration Subsurface Investigation Elements
<p><u>Minimum Investigation Depth</u> At least 10 feet below regional groundwater table or into aquitard underlying target soil</p>
<p><u>Characterization for each soil and/or rock unit (strata with the same texture, color/mottling, density, and type)</u> Same as Standard Subsurface Investigation (<i>Section D-2.4</i>)</p>
<p><u>Detailed logs for each investigation</u> Same as Standard Subsurface Investigation (<i>Section D-2.4</i>)</p>

D-3. Infiltration Tests

D-3.1. Description

Step 4 in *Volume 3, Section 3.2*, is Conduct Infiltration Testing. This section provides procedures for the following infiltration testing methods:

- Simple Infiltration Test (Small-scale infiltration test)
- Small Pilot Infiltration Test (PIT)
- Large PIT
- Deep infiltration test

To determine which infiltration test method is required for a project, refer to Table 3.1 and Table 3.2 in *Volume 3, Section 3.2*.

If possible, perform infiltration testing at the location of the proposed infiltration [facilityBMP](#). Infiltration testing results from a nearby location within 50 feet of the proposed infiltration [facilityBMP](#) may be approved at the discretion of the licensed professional. If ~~the infiltration testing is performed more than 50 feet from the final infiltration facility location due to existing site conditions (e.g., existing structure at location of proposed facility) and~~ greater than 5,000 sf is infiltrated on the site, then acceptance testing is required (refer to *Volume 3, Section 3.2*).

If variable soil conditions are observed at the site, multiple infiltration tests are recommended in the different soil types.

After the measured infiltration rates are determined using the procedures provided in this section, correction factors must be applied to calculate the design infiltration rate used for BMP sizing (refer to *Section D-4*).

The test method may be modified due to site conditions if recommended by the licensed professional and the reasoning is documented in the report. Any modifications to the proposed test method should be approved by the City.

D-3.2. Simple Infiltration Test

The Simple Infiltration Test is a small-scale infiltration test procedure adapted from the Washington State Department of Ecology (Ecology) Rain Garden Handbook for Western Washington (<https://fortress.wa.gov/ecy/publications/SummaryPages/1310027.html>).

The Simple Infiltration Test does not require a licensed professional.

The Simple Infiltration Test is not allowed for projects with no off-site point of discharge (*Volume 3, Section 4.3.2-4*). These projects shall use a Small PIT.

Procedure

If testing is performed during the wet season (November through March), only one test is required. If the test is performed during the dry season (April through October), two tests must be performed in same hole within 2 days, with the beginning of each test spaced 24 hours apart.

1. Dig a hole a minimum of 2 feet deep. Preferably, the depth of the hole should be measured from the bottom of the facility but at a minimum shall be measured from the proposed site finished grade. The hole shall be at least 2 feet in diameter.
2. Record the type and texture of the soil. If the soil is primarily fine-grained such as silt or clay, or is glacial till, infiltration may not be feasible.
3. At the same time that you dig your test hole, check for high groundwater by using a post hole digger to excavate a hole to the minimum subsurface investigation depth, as provided in *Section D-2.3*, approximately 5 feet from the test hole. If standing water or seeping water is observed in the hole, measure the depth to the standing water or seepage.
4. Pre-soak period: Add 12 inches of water to the hole. This can be measured using a ruler, scale, or tape measure. Be careful to avoid splashing, which could erode the sides of the hole or disturb the soil at the base of the hole.
5. Record the depth of water in the hole in inches.
6. Record the time water was added to the hole.
7. Check and record the time and depth of water in the hole on an hourly basis for up to two hours. Estimate the infiltration rate in inches per hour by calculating the drop in water level in inches for each hour. Based on the lowest of these measurements, determine which time interval to use for the infiltration test by following these guidelines:
 - >3 inch per hour fall, check at 15-minute intervals
 - 3 inch to 1 inch per hour fall, check at 30-minute intervals
 - <1 inch per hour fall, check at hourly intervals
8. Infiltration Test: Fill the hole back up to a depth of 12 inches. Check and record the time and depth of water in the hole at regular intervals based on the time interval

determined during the presoak period for a total of six measurements. If the hole empties prior to the six measurements, refill and continue recording until you have recorded six measurements.

9. Calculate measured infiltration rate. Refer to Table 3.3 in *Volume 3, Section 3.2*, for minimum infiltration rates for each type of infiltration BMP. Using the collected data, estimate the ~~measured~~-infiltration rate in inches per hour by calculating the drop in water level in inches for each hour data was collected during the infiltration test. There should be a total of six values. The lowest calculated value is the measured infiltration rate in inches per hour
10. Mark test locations on site map.

D-3.3. Small Pilot Infiltration Test (Small PIT)

The testing procedure and data analysis requirements for the Small PIT are provided below. The report for this test shall include documentation of the testing procedure, analysis and results to assess infiltration feasibility and an explanation of the correction factor used to determine the design infiltration rate.

The Small PIT report shall be prepared by a licensed professional. The test method may be modified due to site conditions if recommended by the licensed professional and the reasoning is documented in the report.

Procedure

1. Excavate the test pit to the depth of the bottom of the proposed infiltration ~~facility~~BMP. In the case of bioretention, excavate to the lowest estimated elevation at which the imported soil mix will contact the underlying soil. For permeable pavement, excavate to the elevation at which the imported subgrade materials, or the pavement itself, will contact the underlying soil. If the underlying soils (road subgrade) will be compacted, compact the underlying soils prior to testing. Note that the permeable pavement design guidance recommends compaction not exceed 90 to 92 percent.
2. Lay back the slopes sufficiently to avoid caving and erosion during the test. Alternatively, consider shoring the sides of the test pit.
3. The size of the bottom of the test pit shall be a minimum of 12 square feet (sf). ~~Accurately d~~Document the size and geometry of the test pit.
4. Install a device capable of measuring the water level in the pit during the test. This may be a pressure transducer (automatic measurements) or a vertical measuring rod (minimum 5 feet long) marked in half-inch increments in the center of the pit bottom (manual measurements).
5. Use a rigid pipe with a splash plate or some other device on the bottom to convey water to the bottom of the pit and reduce side-wall erosion and excessive disturbance of the pit bottom. Excessive erosion and bottom disturbance may result in clogging of the infiltration receptor and yield lower than actual infiltration rates.
6. Pre-soak period: Add water to the pit so that there is standing water for at least 6 hours. Maintain the pre-soak water level at least 12 inches above the bottom of the pit.

7. Steady state period:
 - a. At the end of the pre-soak period, add water to the pit at a rate that will maintain a depth of 12 inches above the bottom of the pit over a full hour.
 - b. Every 15 minutes during the steady state period, record the cumulative volume and instantaneous flow rate (in gallons per minute) necessary to maintain the water level at the same point (the design ponding depth) on the measuring rod or pressure transducer readout.
8. Falling head period: After 1 hour, turn off the water and record the rate of infiltration (the drop rate of the standing water) in inches per hour every 15 minutes using the pressure transducer or measuring rod data, for a minimum of 1 hour or until the pit is empty.
9. Within 24 hours after the falling head period~~At the conclusion of testing~~, over-excavate the pit to determine if the test water is mounded on shallow restrictive layers or if it has continued to flow deep into the subsurface. The investigation depth varies depending on the type of subsurface investigation required (refer to Table 3.1 in *Volume 3, Section 3.2*) and the seasonal timing of the geotechnical exploration conducted to evaluate clearance. Minimum investigation depths are provided in *Section D-2*.

Data Analysis

Using the established steady state flow rate, calculate and record the measured infiltration rate in inches per hour. Use the falling head data to confirm the measured infiltration rate calculated from the steady state data.

Adjust the measured infiltration rate using the correction factor (CF) described in *Section D-4* to estimate the design infiltration rate.

D-3.4. Large Pilot Infiltration Test (Large PIT)

A Large PIT will more closely simulate actual conditions for the infiltration [facilityBMP](#) than a Small PIT and may be preferred at the discretion of the licensed professional if not already required per Table 3.1 in *Volume 3, Section 3.2*. The testing procedure and data analysis requirements for the Large PIT are provided below. The report for this test shall include documentation of the testing procedure, analysis and results to assess infiltration feasibility and an explanation of the correction factor used to determine the design infiltration rate.

The Large PIT report shall be prepared by a licensed professional. The test method may be modified due to site conditions if recommended by the licensed professional and the reasoning is documented in the report.

Procedure

1. Excavate the test pit to the depth of the bottom of the proposed infiltration [facilityBMP](#). In the case of bioretention, excavate to the lowest estimated elevation at which the imported soil mix will contact the underlying soil. For permeable pavement, excavate to the elevation at which the imported subgrade materials will contact the underlying soil. If the underlying soils (road subgrade) will be compacted, compact the

[underlying soils prior to testing. Note that the permeable pavement design guidance recommends compaction not exceed 90 to 92 percent.](#)

2. Lay back the slopes sufficiently to avoid caving and erosion during the test. Alternatively, consider shoring the sides of the test pit.
3. The size of the bottom of the test pit should be as close to the size of the planned infiltration ~~facility~~[BMP](#) as possible, but not less than 32 square feet in area (100 square feet is recommended). Where water availability is an issue, smaller areas may be considered, as determined by the licensed professional. [Accurately D](#)document the size and geometry of the test pit.

Refer to Steps 4 through ~~9~~[40](#) as described in the Small PIT procedure above.

Data Analysis

Refer to the data analysis guidance for small PITs in *Section D-3.3*.

D-3.5. Deep Infiltration Test

The design infiltration ~~rate~~[capacity](#) for deep infiltration shall be determined by performing a constant-rate infiltration test followed by a falling-head infiltration test. The Deep Infiltration Test report shall include documentation of the testing procedure, analysis and results to assess infiltration feasibility and an explanation of the correction factor used to determine the design infiltration ~~rate~~[capacity of the proposed BMP](#).

The Deep Infiltration Test report shall be prepared by a licensed professional. The test method may be modified due to site conditions if recommended by the licensed [professional geotechnical engineer or hydrogeologist](#) and the reasoning is documented in the report.

Procedure

1. Perform the test by adding water (obtained from a potable water source) to the test well to maintain a [constant](#) hydraulic head in the well ~~equal to approximately half the thickness of the unsaturated infiltration receptor soil layer.~~ [The specific target hydraulic head will depend on the subsurface conditions, the design and construction of the test well, and the project goals. As a starting point, it is recommended to saturate the entire screened portion of the test well that is within the target soil zone.](#)
2. Monitor the flow rate with a flow meter or other method that is capable of measuring flow to within 5 percent of the total flow rate.
3. Monitor water levels in the test well with a pressure transducer and datalogger on a maximum of 5-minute intervals.
4. Add water until the rate of water added is constant, or for a minimum of 4 hours.
5. Once a constant rate is achieved, the test is complete. Begin the falling head portion of the test. Monitor water levels during the falling [head test](#) until the water level has fallen to a minimum of 5 percent of the total head targeted during the constant rate portion of the test.
6. In addition to the required wells, monitor groundwater elevations in nearby monitoring wells as available.

Data Analysis

The test data shall be evaluated by a licensed hydrogeologist experienced in the analysis of well hydraulics and well testing data. As a result of the likely variability in soil conditions, specific methods for analysis of the data are not provided. It is the responsibility of the professional analyzing the data to select the appropriate methodology.

D-4. Infiltration Rate Correction Factor

Measured infiltration rates described in *Section D-3* shall be reduced using correction factors to determine the design infiltration rates. The determination of a design infiltration rate from in-situ infiltration test data involves a considerable amount of engineering judgment. Therefore, when determining the final design infiltration rate, the licensed professional shall consider the results of both soil subsurface material conditions and in-situ infiltration tests results. In no case shall the design infiltration rate exceed 10 inches per hour.

$$\text{Design Infiltration Rate} = \text{Measured Infiltration Rate} \times \text{CF}$$

A correction factor (CF) is applied to the measured infiltration rate to calculate the design infiltration rate. The design infiltration rate shall be used when sizing infiltration BMPs using the design criteria outlined in *Volume 3, Section 5.4*.

D-4.1. Simple Infiltration Test

A CF of 0.5 shall be applied to the measured infiltration rate to calculate the design infiltration rate.

D-4.2. Small and Large PITs

A CF of 0.5 must be used for all projects unless a lower value is warranted by site conditions, as recommended and documented by a licensed professional, and shall not be less than 0.2. In determining an appropriate CF, the following criteria shall be considered and are described below:

- Site variability and number of locations tested
- Uncertainty of test method
- Degree of influent control to prevent siltation and bio-buildup

Site variability and number of locations tested – This criterion depends on the level of uncertainty that adverse subsurface conditions may exist. The number of locations tested must be sufficient to represent the conditions throughout the [facilityBMP](#) site. The following are examples of how site variability and number and locations of the tests may affect uncertainty:

- The subsurface conditions are known to be uniform based on previous exploration and site geological factors, one PIT may be adequate to justify that the uncertainty for that site is low.
- High variability may exist due to subsurface conditions (such as buried stream channels) identified on previous explorations and site geological factors. In these

cases, even with many explorations and several PITs, the level of uncertainty may still be high.

- High uncertainty could also be assigned where conditions have a more typical variability, but few explorations and only one PIT is conducted. That is, the number of explorations and tests conducted do not match the degree of site variability anticipated.

Uncertainty of test method – This criterion represents the accuracy of the infiltration test method used. Larger scale tests are assumed to produce more reliable results (i.e., the Large PIT is more certain than the Small PIT).

Degree of influent control to prevent siltation and bio-buildup – High uncertainty for this criterion may be justified under the following circumstances:

- If the infiltration [facilityBMP](#) is located in a shady area where moss buildup or litter fall buildup from the surrounding vegetation is likely and cannot be easily controlled through long-term maintenance.
- If there is minimal pre-treatment, and the influent is likely to contain moderately high total suspended solids (TSS) levels.

If influent into the [facilityBMP](#) can be well controlled such that the planned long-term maintenance can easily control siltation and biomass buildup, then low uncertainty may be justified for this criterion.

D-5. Groundwater Monitoring

Groundwater monitoring wells (including the minimum subsurface investigation depth) shall be installed as determined in *Sections D-2.3 through D-2.6* under the direct supervision of a licensed professional. The minimum number of groundwater monitoring wells, duration of monitoring, and frequency of monitoring are summarized in Table 3.1 and Table 3.2 in *Volume 3, Section 3.2*. A report shall be developed that is prepared by a licensed professional and includes a map detailing the locations of the monitoring wells relative to the project site and a description of the groundwater levels relative to the investigation depth and vertical separation requirements provided in *Section D-2*.

Groundwater monitoring is not required in the following situations [when using shallow infiltration BMPs](#):

- Elevation data measured at project monitoring wells shows groundwater levels within the investigation depth and vertical separation requirements summarized in *Section D-2*
- Available groundwater elevation data within 50 feet of the proposed infiltration [facilityBMP](#) shows the highest measured groundwater level to be at least 10 feet below the bottom of the proposed infiltration [facilityBMP](#) or if the initial groundwater measurement is more than 15 feet below the bottom of the proposed infiltration facility

In these situations, no further investigation is required to meet on-site, flow control, or water quality treatment requirements. These exceptions do not apply to deep infiltration BMPs.

D-6. Characterization of Infiltration Receptor

The infiltration receptor is the unsaturated and saturated soil receiving stormwater from an infiltration [facilityBMP](#). Thresholds for triggering characterization of the infiltration receptor are summarized in Table 3.1 and Table 3.2 in *Volume 3, Section 3.2*.

Assessment and documentation by a licensed hydrogeologist characterizing the infiltration receptor shall include the following elements:

- Depth to groundwater and to hydraulically-restrictive material
- Seasonal variation of groundwater table based on well water levels and observed mottling of soils
- Existing groundwater flow direction and gradient
- Approximation of the lateral extent of infiltration receptor
- Volumetric water holding capacity of the infiltration receptor soils. The volumetric water holding capacity is the storage volume in the soil layer directly below the infiltration [facilityBMP](#) and above the seasonal high groundwater mark, or hydraulically-restrictive material.
- Horizontal hydraulic conductivity of the saturated zone to assess the aquifer's ability to laterally transport the infiltrated water

Note: As part of the infiltration receptor characterization for deep infiltration wells, the pretreatment requirements shall be evaluated as in the UIC Guidance Manual (Ecology 2006).

D-7. Groundwater Mounding and Seepage Analysis

Infiltration of large volumes of water may result in a rise in the water table or development of a shallow water table on hydraulically-restrictive materials that slow the downward percolation of water. If this mounding of water is excessive, the infiltration [facilityBMP](#) may become less effective and/or adjacent structures or facilities may be impacted by the rising water table. In addition, if the infiltration [facilityBMP](#) is adjacent to a slope, slope stability may be decreased.

Thresholds for triggering groundwater mounding and seepage analysis are summarized in Table 3.1 and Table 3.2 in *Volume 3, Section 3.2*.

The mounding analysis shall evaluate the impact of the infiltration [facilityBMP](#) on local groundwater flow direction and water table elevations and determine whether there would be any adverse effects caused by seepage zones on nearby building foundations, basements, roads, parking lots or sloping sites. If the results of the mounding analysis indicate that adverse conditions could occur, as determined by a licensed professional, the infiltration [facilityBMP](#) shall not be built.

If infiltration on the site may result in shallow lateral flow (interflow), the conveyance and possible locations where that interflow may re-emerge ~~shall~~ be assessed by a licensed hydrogeologist.

For deep infiltration BMPs, the following shall also be evaluated:

- Extent of groundwater mounding under the design flow rate
- Potential impacts from the groundwater mounding to:

- Deep infiltration BMP performance
- Surrounding infrastructure, including, but not limited to, infiltration [facilitiesBMPs](#), drainage facilities, foundations, basements, utility corridors, or retaining walls
- Offsite slope stability
- Down-gradient existing contamination plumes

Several analytical tools are available to evaluate potential groundwater mounding beneath infiltration [facilitiesBMPs](#). These include both analytical and numerical groundwater flow software. In general, public domain software programs shall be used (such those initially authored by the United States Geological Survey (USGS) or the Environmental Protection Agency).

The software program MODRET is considered a standard tool for evaluating infiltration [facilitiesBMPs](#), and is recommended in Ecology’s Stormwater Management Manual for Western Washington. Although MODRET is a proprietary computer program, it is readily available for purchase and is based on USGS software. However, MODRET is limited to evaluation of a single [facilityBMP](#) at a time, and generally will not be suitable for evaluating clustered [facilitiesBMPs](#).

The preferred program for simulating groundwater mounding beneath infiltration [facilitiesBMPs](#) is the USGS-based program MODFLOW. MODFLOW can be used to simulate a wide range of aquifer conditions and geometries. The primary limitation with MODFLOW is that most versions of the program do not simulate the movement of water through the unsaturated zone, which would normally be expected to slow the downward movement of water and allow for lateral spreading of water before reaching the water table. Instead, infiltrating water is input directly to the water table. For a shallow water table or perching layer this limitation should not greatly influence the overall results of the mounding simulation and represents a more conservative approach to simulating mounding.

Licensed hydrogeologists with formal training and experience in developing groundwater flow models ~~shall~~ conduct these analyses. It should also be noted that groundwater models do not provide specific answers, but are tools to help understand the behavior of groundwater systems under a variety of conditions. The results of any model should be used in the context of the overall goal of the project and be applied as warranted by the risk tolerance of the owner.

D-7.1. Data Requirements

Data requirements for development of a groundwater mounding model include:

- Soil and groundwater conditions
- Aquifer parameters (e.g., hydraulic conductivity and specific yield)
- Aquifer geometry
- Pre-infiltration hydraulic gradient
- Flow rate from infiltration [facilitiesBMPs](#)

Many of the data inputs for the groundwater mounding model should be available in the vicinity of the infiltration [facilitiesBMPs](#) from the subsurface investigation and infiltration testing performed for design of the [facilitiesBMPs](#). Outside the area of the infiltration

[facilitiesBMPs](#), data may be sparse and may need to be interpolated from regional data. The extent of the modeled area should be such that the edges of the model do not influence the data unless an actual boundary exists, such as Elliott Bay or Lake Washington.

In the absence of local information regarding the groundwater gradient and/or the distribution of hydraulic restrictive layers, mounding analyses should consider the general slope of the site and surrounding sites, as the general slope is likely indicative of the direction of interflow originating from infiltration [facilitiesBMPs](#) and the regional hydraulic gradient.

Aquifer parameters shall be estimated based on knowledge of local soil types and from grain size distribution of the soil samples collected as part of the subsurface investigation and testing program. In general, groundwater flow models tend to be most sensitive to variations in hydraulic conductivity values. Obtain hydraulic conductivity values from field testing of the infiltration receptor soils using standard industry methods.

D-7.2. Analysis Procedures

The initial step for any groundwater modeling analysis is the development of a conceptual model of the groundwater system. The conceptual model should describe the anticipated groundwater flow system including the data requirements described above, direction and rate of groundwater flow, potential model boundaries, and approach for simulating infiltration. The conceptual model provides the basis for constructing the computer model.

Because of the limited available data necessary for model inputs, a parametric analysis shall be performed whereby model inputs, especially aquifer parameters, are varied over a range of values to evaluate the potential impact on the mounding results. The range values shall be based on known variability in the parameter and experience with similar soils in the area by the licensed professional developing the model.

The following ranges of aquifer parameters shall be used in the parametric analysis:

- Hydraulic conductivity: one order of magnitude (e.g., + and - a power of 10) for each receptor soil
- Aquifer thickness: plus or minus 50 percent of the known values
- Specific yield: minimum range of 0.05 to 0.2

If known field conditions warrant, increase the above ranges as necessary.

In general, multiple infiltration scenarios will need to be simulated to evaluate potential mounding below the infiltration [facilitiesBMPs](#). For example, both short-term peak storm events and long-term seasonal precipitation should be evaluated. Additional scenarios may include a series of short-term high precipitation events. Although the actual events that need to be simulated will depend on subsurface conditions, number and types of infiltration [facilitiesBMPs](#), and potential risk factors, as a minimum the following scenario is required:

- A typical wet season (November through April) based on average monthly precipitation followed by a single-event rainfall modeling of the back-loaded long-duration storm for the 100-year recurrence interval, using data from the closest rain gage.

The licensed hydrogeologist performing the mounding analysis should use professional judgment and experience to potentially modify the above scenario or add additional scenarios on a project specific basis, as needed.

As additional soil and groundwater information is collected during construction, testing, and operation of the infiltration [facilityBMP](#), the mounding analysis should be revised and refined to incorporate any new information. If groundwater monitoring indicates results inconsistent with the findings of the mounding analysis, in the opinion of a licensed hydrogeologist, the model should be re-evaluated. The re-evaluation should include simulation of the precipitation events prior to the observed groundwater monitoring data.

D-8. Acceptance Testing

Acceptance testing is required for shallow infiltration BMPs receiving runoff from greater than 5,000 square feet of impervious surface area, including:

- [Infiltration Trenches](#)
- [Drywells](#)
- [Infiltration Bioretention \(with and without underdrains\)](#)
- [Infiltration Basins](#)
- [Infiltration Chambers](#)

It may also be required for infiltration BMPs receiving runoff from a smaller contributing area, if required by the Director. Refer to *Volume 3, Section 3.2*.

All permeable pavement facilities and surfaces are required to perform acceptance testing per Wearing Course Subsection in *Volume 3, Section 5.4.6.5*. Acceptance testing of deep infiltration BMPs shall consist of the infiltration testing for deep infiltration wells described in *Section D-3.5* performed on the completed permanent wells.

D-8.1. Acceptance Criteria Definitions

The purpose of acceptance testing is to confirm the constructed infiltration BMP will perform in accordance with design. Infiltration acceptance criteria include:

1. **Subsurface Condition Observations:** The observed soil and groundwater conditions in the excavated BMP shall exhibit no adverse conditions that will result in:
 - a. The maximum pool drawdown time to be exceeded. Refer to Criterion 4 (Pool Drawdown Time).
 - b. For BMPs intended to provide flow control or onsite stormwater management, a long-term infiltration rate lower than the design rate.
 - c. For BMPs intended to provide water quality treatment, a long-term infiltration rate that is higher than the design rate.

Observation and confirmation of the subsurface conditions shall be conducted by a licensed professional who is familiar/experienced with the field infiltration testing performed during design.

2. **Underlying Soil Infiltration Rate:** For BMPs without underdrains which rely on soil infiltration, the underlying soil infiltration rate achieved after construction of the infiltration BMP and adjusted to determine a long-term rate using correction factors shall be:

- a. High enough to ensure that the maximum pool drawdown time is not exceeded. Refer to Criterion 4 (Pool Drawdown Time).
 - b. Equal to or greater than the design infiltration rate, where flow control or onsite stormwater management is intended.
 - d.c. Less than or equal to the design infiltration rate where water quality treatment is intended.
- 7-3. Bioretention Soil Infiltration Rate: When water is applied to the infiltration BMP, it shall readily infiltrate into the bioretention soil and drain downward. If water ponds and does not drain downward, compaction or otherwise compromised bioretention soil is indicated.
4. Pool Drawdown Time: The surface pool drawdown time for maximum ponding depth shall be less than 24 hours after water has ceased being added to the BMP.

D-8.2. Acceptance Testing Requirements

Acceptance testing is intended to evaluate the post-construction infiltration performance of the BMP; therefore, timing of the testing during construction is important and shall be performed after all construction activities that could impact the targeted infiltration soil are completed. Activities such as compaction and contamination by finer soil particles can reduce the infiltration rate of bioretention and underlying soil. Water that runs off into the BMP that is not clear and contains sediment can reduce the infiltration rate of the BMP.

Infiltration acceptance testing shall be performed up to three steps. Steps 1 and 2 are recommended but optional. Step 3 is required.

Step 1. Observation of the Subsurface Conditions (optional)

During construction of the BMP, it is recommended that a licensed professional who is familiar/experienced with the field infiltration testing performed during design be on site to observe subsurface soil conditions and confirm the underlying soil conditions are consistent with those observed during the design infiltration testing. Refer to Criterion 1 (Subsurface Condition Observations) in Section D-8.1. If the soil conditions are observed to be consistent with design observations and testing, proceed to Step 3. If soil conditions are not consistent with design observations and testing, it is recommended to proceed to Step 2.

Step 2. Infiltration Testing of Differing Soil Conditions (optional)

If the subsurface soil conditions are observed to be different than design observations and testing, and the BMP is designed to rely on infiltration into the underlying soil, infiltration testing is recommended immediately (prior to backfilling the BMP) to determine if the underlying soil meets the design infiltration rate. For BMPs with multiple cells, one test in a representative cell per soil type shall be required. Although it is preferred that acceptance testing be performed in a similar manner as the design infiltration testing, specific procedures can be based on the professional judgement of the licensed professional who performed the testing during design. If the infiltration rate adjusted to a long-term rate using correction factors meets Criterion 2 (Underlying Soil Infiltration Rate)

in Section D-8.1, proceed to Step 3. If the rate adjusted to a long-term rate does not meet Criterion 2 (Underlying Soil Infiltration Rate) in Section D-8.1, retesting or redesign and reconstruction of the BMP shall be required.

Step 3. Acceptance Testing of Backfilled BMP (required)

Testing in this step shall be performed once the BMP has been backfilled, but prior to planting, if applicable:

- For BMPs without underdrains which rely on underlying soil infiltration, the acceptance test shall consist of testing the drawdown time to confirm it is less than or equal to the design ponding criteria. Refer to Criterion 4 (Pool Drawdown Time) in Section D-8.1. For BMPs with multiple cells, one test in a representative cell per soil type shall be required. If the acceptance test fails and the BMP performance is not equal to or better than the performance required by the design (refer to Criteria 3 and 4 [Bioretention Soil Infiltration Rate and Pool Drawdown Time] in Section D-8.1), then retesting or redesign and reconstruction of the BMP shall be required.
- For BMPs with an underdrain, acceptance testing shall verify the surface pool drawdown time for the maximum ponding depth meets the ponding criteria of the design or better. Refer to Criteria 3 and 4 (Bioretention Soil Infiltration Rate and Pool Drawdown Time) in Section D-8.1. If the acceptance test fails and the BMP performance is not equal to or better than the performance required by the design, then retesting or redesign and reconstruction of the BMP shall be required.

A monitoring well or piezometer is needed for Step 3 to observe water levels within the BMP if the BMP does not have an underdrain. For drywells, infiltration trenches and bioretention with an underdrain, the cleanout or observation port may be used to observe water levels if it allows accurate measurement of underlying soil infiltration. Drilling rigs or other mechanical methods are prohibited within the BMP footprint during construction; therefore, wells or piezometers must be placed using hand methods. The base of the well or piezometer shall be placed at the bottom of the BMP directly on top of the infiltrating soil.

D-8.3. Acceptance Testing Plan

An acceptance testing plan shall be prepared and submitted to the City signed and stamped by a licensed professional. The acceptance testing plan shall include, but is not limited to:

- A site plan showing and listing the proposed infiltration BMPs requiring acceptance testing.
- Measured infiltration rates, correction factors and infiltration testing backup data relied on for design.
- Infiltration testing procedures and specifications including an estimate of the amount of water, duration, rate to apply water to the BMP required for conducting the test and potential source of water.
- Specifications for monitoring wells, piezometer, and/or observation ports to be install for testing and observation.
- Procedure for submittal and acceptance of results.

The acceptance testing plan shall be updated and resubmitted as required based on review by the City.

D-8.4. Acceptance Testing Submittal

The results of the acceptance testing shall be summarized in a memorandum signed and stamped by a licensed professional and submitted for final approval. The memorandum shall include:

- The infiltration rates, correction factors and infiltration testing backup data relied on for the design.
- The measured infiltration rates, correction factors and infiltration testing backup data resulting from the acceptance testing.
- A discussion of subsurface soil condition observations performed in Step 1. State why additional testing of subsurface conditions were or were not required.
- A discussion comparing the results of the Step 2 acceptance infiltration test (if performed) to the results of the design infiltration test. State whether the results of this test indicate the BMP will perform as intended during design.
- A discussion comparing the results of the Step 3 acceptance infiltration test to the results of the design infiltration test. State whether the results of this test indicate the BMP will perform as intended during design.
- If the acceptance testing is performed during the dry season, the licensed professional shall make a statement regarding the expected impact to the measured infiltration rate and how the BMP is expected to perform in the wet season.

APPENDIX E

Additional Design Requirements and Plant Lists

This Cover to be Replaced in PDF
with SPU-Provided Cover

Note:

Some pages in this document have been purposely skipped or blank pages inserted so that this document will copy correctly when duplexed.

Table of Contents

E-1.	Flow Control Structures	1
	General Requirements	3
	Access	4
	Design Criteria	4
	Multiple Orifice Restrictor	4
	Weir Restrictor	5
	Flow Control Device Sizing	5
	Orifices	5
	Riser Overflow	7
E-2.	Flow Splitters	9
	General Design Criteria	9
	Materials	9
E-3.	Flow Spreaders	13
	General Design Criteria	13
	Option A – Anchored Plate	13
	Option B – Concrete Sump Box	14
	Option C – Notched Curb Spreader	14
	Option D – Through-Curb Ports	14
	Option E – Interrupted Curb	15
E-4.	Level Spreaders	17
	Definition	17
	Purpose	17
	Condition Where Practice Applies	17
	Planning Considerations	17
	Design Criteria	17
	Maintenance	19
E-5.	Pipe Slope Drains	21
	Definition	21
	Purpose	21
	Conditions Where Practice Applies	21
	Planning Considerations	21
	Design Criteria	22
	Maintenance	23
E-6.	Outlet Protection	25
	Definition	25
	Purpose	25
	Condition Where Practice Applies	25

Planning Considerations.....	25
Design Criteria.....	25
Maintenance	26
E-7. Liners	27
Design Criteria for Treatment Liners	28
Design Criteria for Low Permeability Liners	29
Compacted Till Liners	29
Clay Liners.....	30
Concrete Liners.....	30
Design Criteria for Impermeable Liners	31
Geomembrane Liners	31
E-8. Geotextiles.....	33
E-9. Plant Lists for Bioretention, Biofiltration Swales, Sand Filters, and Wet Ponds.....	35
Bioretention.....	35
Biofiltration Swales	71
Sand Filters	74
Wet Ponds.....	75
E-10. Drywell Sizing Tables	76

Tables

Table E.1. Spreader Length Based on 10-Year, 24-Hour Storm.	19
Table E.2. Lining Types Required by BMP Type.	28
Table E.3. Compacted Till Liners.	30
Table E.4. Part Shade List.	37
Table E.5. Sun List.	40
Table E.6. Native List (Sun to Part Shade includes cultivars).	46
Table E.7. Intersection and View Restriction Palette (under 24 inches in height).	53
Table E.8. Vertical Shrubs and Accent Plants.	56
Table E.9. Groundcovers if Low Profile is Required.	59
Table E.10. Steppable Plants.	61
Table E.11. Conifers (deciduous and evergreen).	62
Table E.12. Medium/Large Broad-leaved Evergreen Trees.	62
Table E.13. Large Deciduous Columnar Trees.....	63
Table E.14. Large Deciduous Trees.	64
Table E.15. Medium/Large Deciduous Trees.	65

Table E.16.	Medium Columnar Deciduous Trees.	66
Table E.17.	Medium Deciduous Trees.	67
Table E.18.	Small Conifer/Broad-leaved Evergreen Trees.	68
Table E.19.	Small Deciduous Trees.	69
Table E.20.	Plants Tolerant of Frequent Saturated Soil Conditions or Standing Water.	71
Table E.21.	Plants Suitable for the Upper Side Slopes of a Biofiltration Swale.	72
Table E.22.	Recommended Plants for Wet Biofiltration Swales.	73
Table E.23.	Recommended Plants for Sand Filters.	74
Table E.24.	Plants for Wet Pond Peripheries.	75
Table E.25.	Drywell Sizing Downstream of Bioretention Sized for Water Quality Treatment Standard or Permeable Pavement Facility.	76
Table E.26.	Drywell Sizing Downstream of Bioretention Sized for the Pre-Developed Pasture Standard.	77
Table E.27.	Drywell Sizing Downstream of Bioretention Sized for the On-Site Stormwater Management Standard.	77
Table E.28.	Drywell Sizing Without Bioretention or Permeable Pavement Facility Upstream.	78

Figures

Figure E.1.	Simple Orifice.	1
Figure E.2.	V-Notch, Sharp-Crested Weir.	2
Figure E.3.	Rectangular Notch, Sharp-Crested Weir.	3
Figure E.4.	Riser Inflow Curves.	6
Figure E.5.	Flow Splitter Example A.	10
Figure E.6.	Flow Splitter Example B.	11
Figure E.7.	Level Spreader Prior to Backfill and Downstream Stabilization.	18
Figure E.8.	Pipe Slope Drain Details.	21

Appendix E includes additional design requirements for the following:

- Flow Control Structures (*Section E-1*)
- Flow Splitters (*Section E-2*)
- Flow Spreaders (*Section E-3*)
- Level Spreaders (*Section E-4*)
- Pipe Slope Drains (*Section E-5*)
- Outlet Protection (*Section E-6*)
- Facility Liners (*Section E-7*)
- Geotextiles (*Section E-8*)
- Plant Lists for Bioretention, Biofiltration Swales, Sand Filters, and Wet Ponds (*Section E-9*)
- Drywell Sizing Tables (*Section E-10*)

E-1. Flow Control Structures

Flow control structures are catch basins or maintenance holes with a restrictor device for controlling outflow from a [facility BMP](#) to meet the desired performance. [Riser type restrictor devices \("tees"\)](#) also provide some incidental oil/water separation to temporarily detain oil or other floatable pollutants in runoff due to accidental spill or illegal dumping.

The [flow control restrictor](#) device usually consists of two or more orifices and/or a weir section sized to meet performance requirements. Standard [flow control device structure](#) details are shown in Figures E.1, [and E.2](#), [and E.3](#) and in [City of Seattle Standard Plan 272a](#).

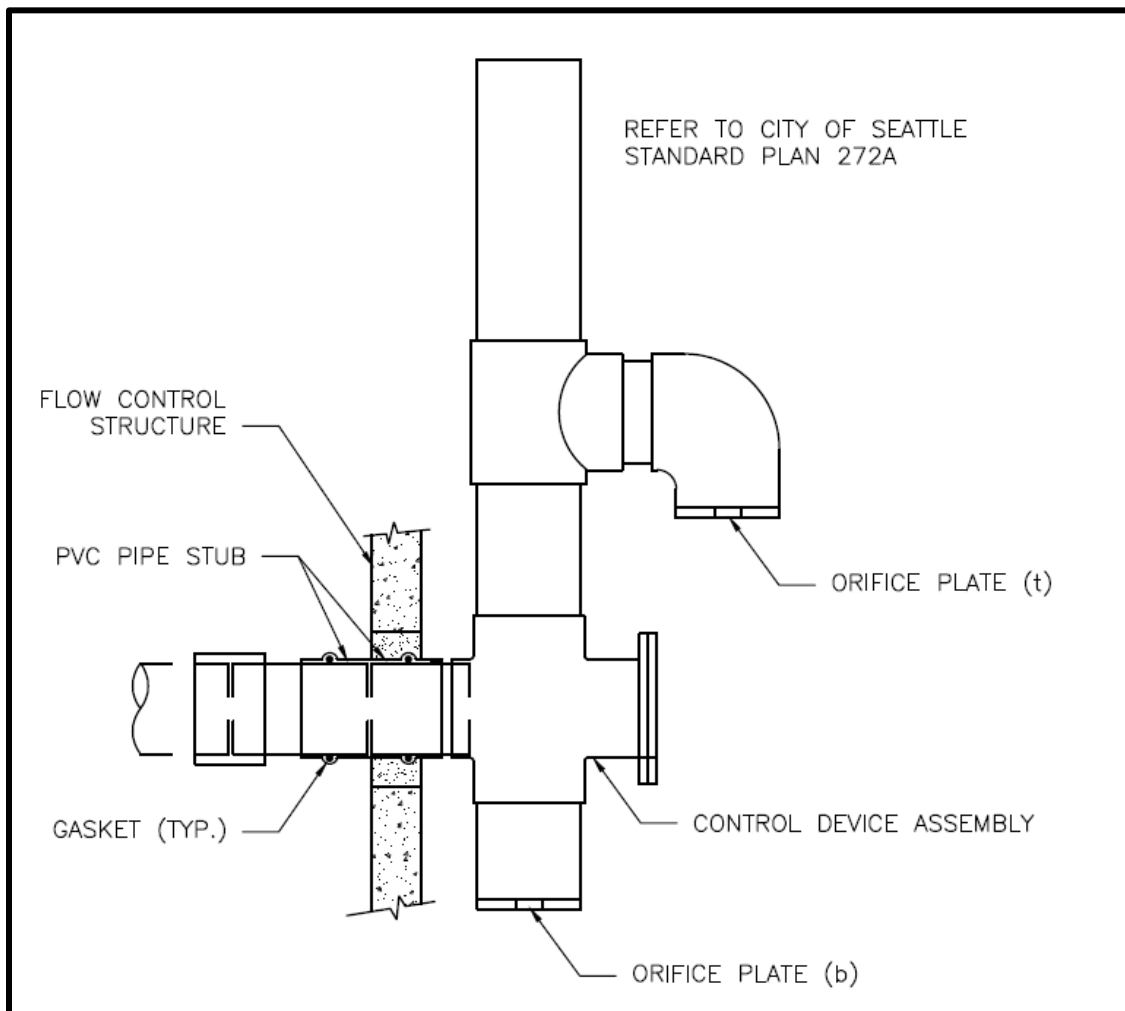

Figure E.1. Simple Orifice.

[For design requirements related to conveyance and drainage refer to Volume 3, Section 4.3.](#)

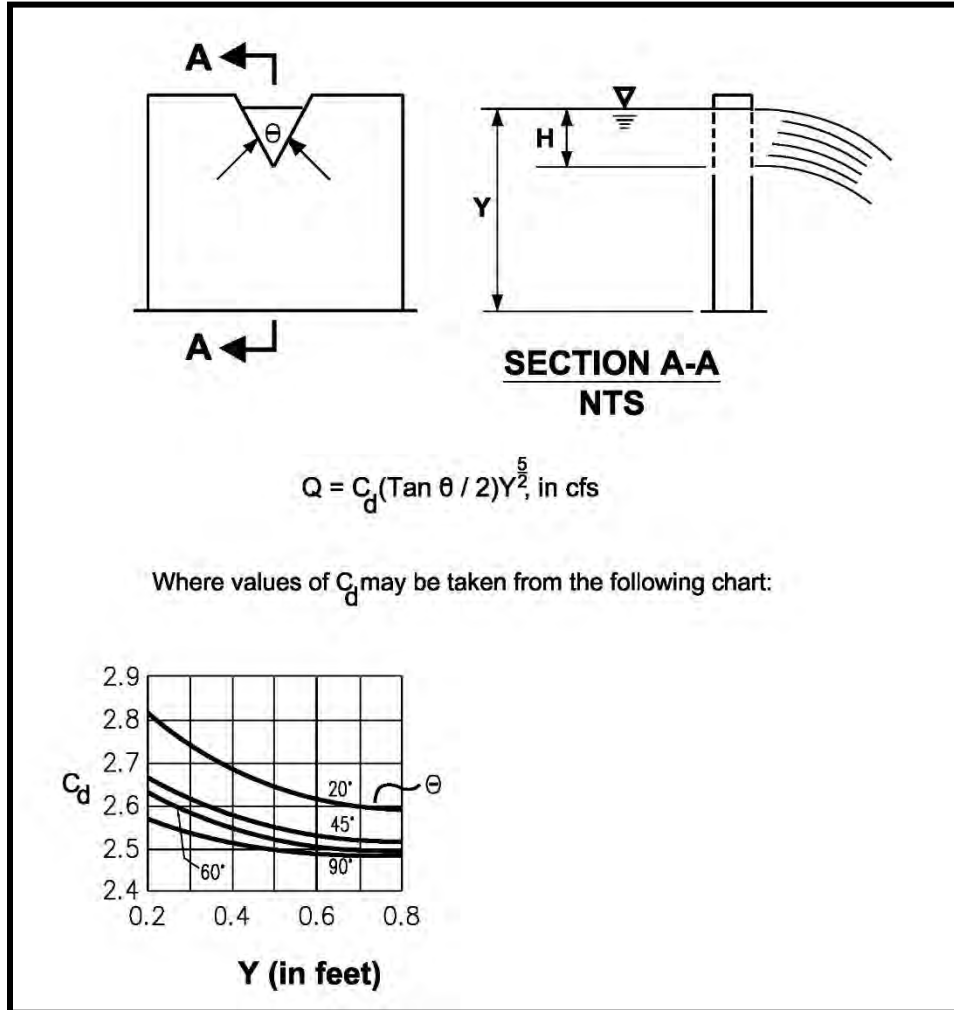

Figure E.2. V-Notch, Sharp-Crested Weir.

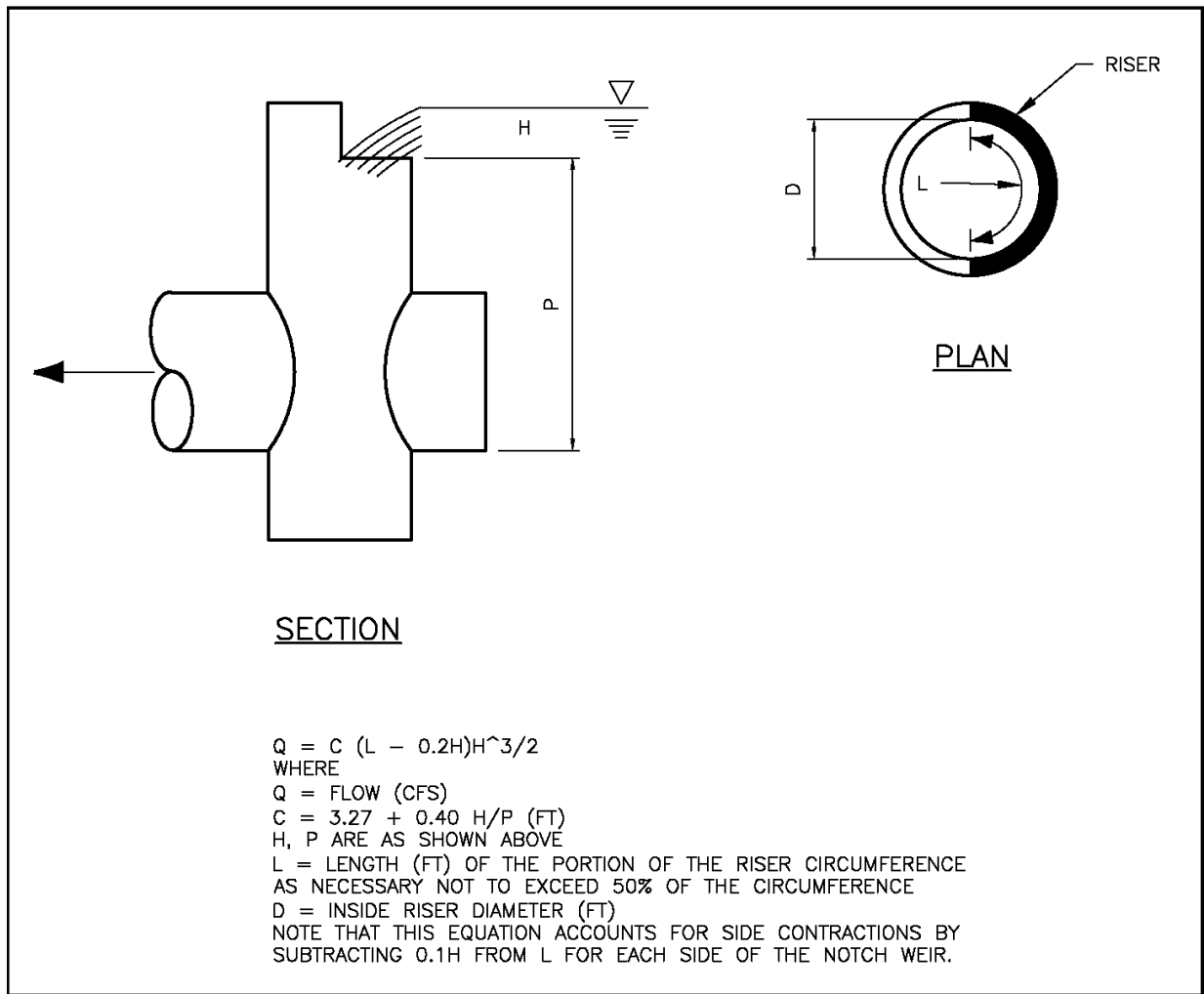

Figure E.3. Rectangular Notch, Sharp-Crested Weir.

General Requirements

Flow control structures shall comply with the specifications outlined in the City of Seattle’s Standard Plans No. 270 and 272A. Additional general requirements are presented below.

Plans submitted for a permit shall include:

- ~~Flow control structure rim elevation;~~
- ~~Storage pipe invert elevation;~~
- ~~Outlet pipe invert elevation;~~
- ~~Elevation at the top of the storage pipe;~~
- ~~Elevation at the top of the overflow pipe;~~
- ~~Orifice diameter(s); and~~
- ~~Orifice elevation(s);~~

For ponding ~~facilities~~BMPs, backwater effects shall be included in designing the height of the downstream conveyance system. High tailwater elevations may affect performance of the restrictor system and reduce live storage volumes.

For regionally sized detention BMPs, non-standard orifice orientation and orifice/weir and gate combinations for flow throttling may be used to meet both stormwater and operational requirements. These general requirements are not meant to be restrictive when a flow control need beyond what is discussed here can be demonstrated.

Access

The following access requirements apply to control structures:

- Access shall be provided to the flow control structure from the ground surface with a three-bolt locking maintenance hole ring and cover (refer to SDCI Director's Rule 2011-4, Requirements for Design & Construction of Side Sewers). Rim elevations shall match proposed finish grade. A rectangular cover, or a cover that allows water to enter through the top of the flow control structure, shall not be used. The ring and cover shall be set so the flow control device or the ladder is visible at the edge of the access opening.
- The inside diameter of the flow control structure shall be at least 4 feet to allow maintenance and repair access, and to accommodate stormwater overflow.
- Maintenance holes and catch basins shall meet the OSHA and WISHA confined space requirements, which include, but are not limited to, clearly marking entrances to confined space areas. This may be accomplished by hanging a removable sign in the access riser under the access lid.
- The flow control device shall ~~be PVC,~~ not ~~be~~ Corrugated Metal Pipe (CMP). The mounting straps and the outlet adapter shall be installed in a manner that will make the flow control device easily removable for maintenance, repair, or replacement. The flow control device shall be designed and located under the maintenance hole ring and cover for inspection from the surface. The outlet pipe adapter may be a plastic, bell-end pipe, or a plastic coupling with rubber gaskets. The outside of the pipe or coupling shall be sanded, epoxy coated, and sand impacted to bond with the flow control structure.

Design Criteria

Multiple Orifice Restrictor

In most cases, control structures only need two orifices: one at the bottom and one near the top of the riser, oriented horizontally. ~~although A~~additional orifices may best utilize detention storage volume in a few cases. ~~Several orifices may be located at the same elevation if necessary to meet performance requirements.~~

Design requirements for multiple orifice flow restrictors are presented below.

- The minimum allowable orifice diameter is 0.5 inches for underground tanks or vaults and 0.25 inches for aboveground cisterns. In some instances, a 0.5-inch bottom orifice

will be too large to meet target release rates, even with minimal head. In these cases, the live storage depth need not be reduced to less than 3 feet in an attempt to meet the performance standards. Also, underground weirs or orifices shall not be reduced to less than 0.5-inch length or diameter in an attempt to meet the performance standards~~under such circumstances, flow throttling devices may be a feasible option. These devices will throttle flows while maintaining a plug-resistant opening.~~

- ~~• Orifices may be constructed on a tee section as shown in City of Seattle Standard Plan No. 270 or on a baffle.~~
- In some cases, performance requirements may require the top orifice/elbow to be located too high on the riser to be physically constructed (e.g., a 13-inch diameter orifice positioned 0.5 feet from the top of the riser). In these cases, a notch weir in the riser pipe may be used to meet performance requirements.

Weir Restrictor

Design requirements for ~~weir~~multiple orifice flow restrictors are presented below.

- ~~• A sharp crested overflow weir shall be used. Weirs may be used as flow restrictors. However, they shall be designed to provide for primary overflow of the detention BMP and should be analyzed for the developed 100-year peak flow dischargeing to the detention facility (Figure E.4E-3).~~
- A notch weir may be used to restrict flows and replace a top orifice.

Flow Control Device Sizing

Orifices

Flow-through orifice plates in the standard tee section or down-turned elbow may be approximated by the general equation:

$$Q = CA\sqrt{2gh}$$

- where
- Q = flow (cfs)
 - C = coefficient of discharge (0.62 for plate orifice)
 - A = area of orifice (ft²)
 - h = hydraulic head (ft)
 - g = gravity (32.2 ft/sec²)

Figure ~~E.4E-3~~ illustrates this simplified application of the orifice equation.

The diameter of the orifice is calculated from the flow. The orifice equation is often useful when expressed as the orifice diameter in inches.

$$d = \sqrt{\frac{36.88Q}{\sqrt{h}}}$$

where d = orifice diameter (inches)
 Q = flow (cfs)
 h = hydraulic head (ft)

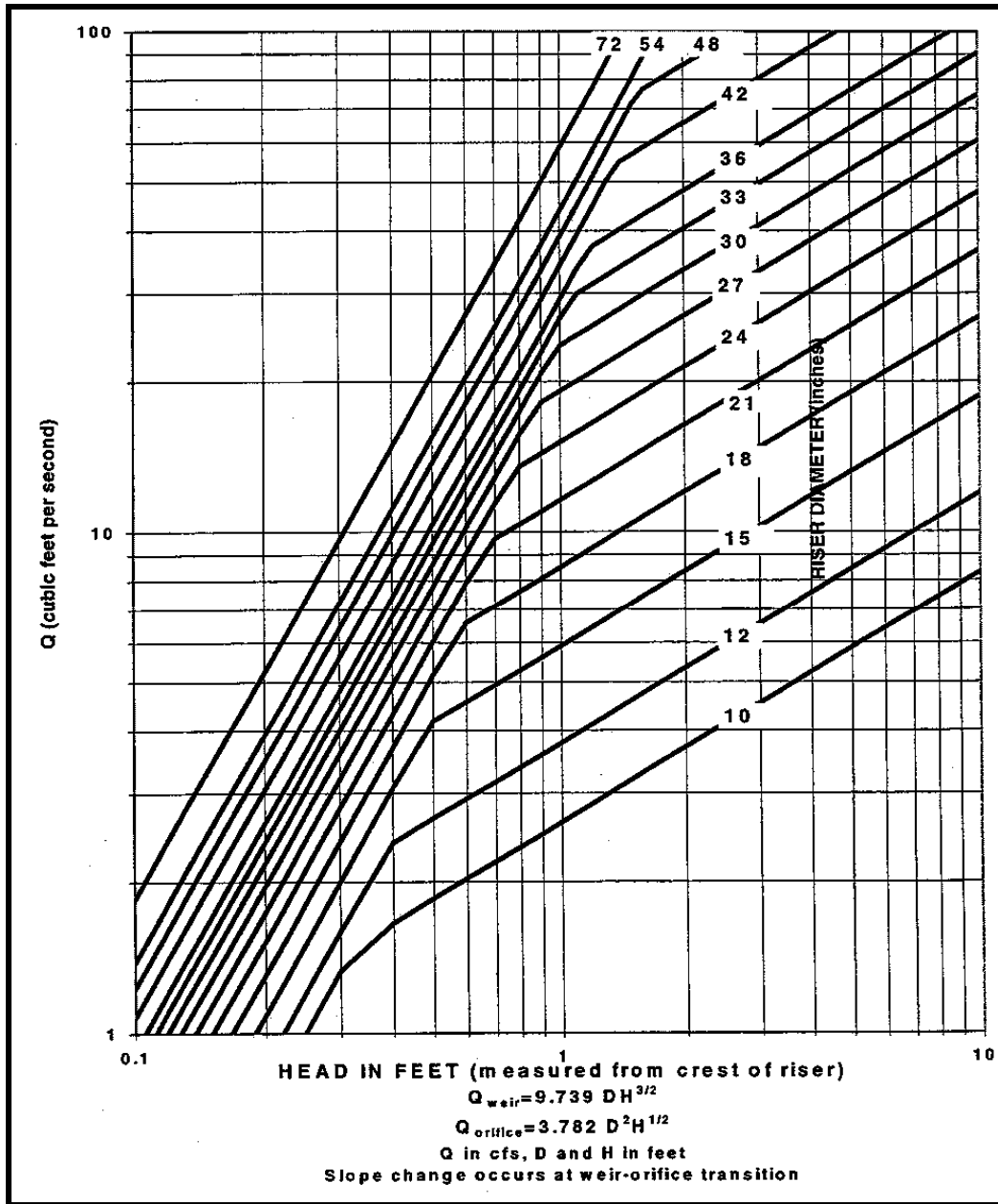

Figure E.4E-3. Riser Inflow Curves.

Riser Overflow

The combined orifice and riser (or weir) overflow may be used to meet performance requirements; however, the design shall still provide for ~~primary~~ overflow of the developed 100-year peak flow assuming all orifices are plugged. The nomograph in Figure ~~E.4E-3~~ can be used to determine the head (in feet) above a riser of given diameter and for a given flow (~~usually the 100-year peak flow for developed conditions~~). For design requirements on overflows, refer to *Volume 3, Section 4.3.4*.

E-2. Flow Splitters

Flow splitters are typically structures with baffles, weirs, or orifice controls. Two examples of maintenance hole flow splitters are shown in Figure [E.5E-4](#) and Figure [E.6E-5](#). Other equivalent designs for splitting flows may also be acceptable.

General Design Criteria

The top of the weir shall be located at the water surface for the design flow. Flows modeled using a continuous simulation model shall be at a 15-minute time step or less.

The maximum head shall be minimized for flow in excess of the water quality design flow. Specifically, flow to the [water quality treatment facility BMP](#) at the 100-year water surface shall not increase the design water quality flow by more than 10 percent.

As an alternative to using a solid top plate in Figure [E.6E-5](#), a full tee section may be used with the top of the tee at the 100-year water surface. This alternative would route emergency overflows (if the overflow pipe were plugged) through the [water quality treatment facility BMP](#) rather than generate back up from the maintenance hole.

Backwater effects shall be included in the design of standpipe height in the maintenance hole.

Materials

- The splitter baffle may be installed in a maintenance hole or vault.
- The baffle wall shall be made of reinforced concrete or another suitable material resistant to corrosion, and have a minimum 4-inch thickness.
- All metal parts shall be corrosion resistant. Examples of required materials include aluminum, stainless steel, and plastic. Zinc and galvanized materials are prohibited because of aquatic toxicity. Painted metal parts shall not be used because of poor longevity.

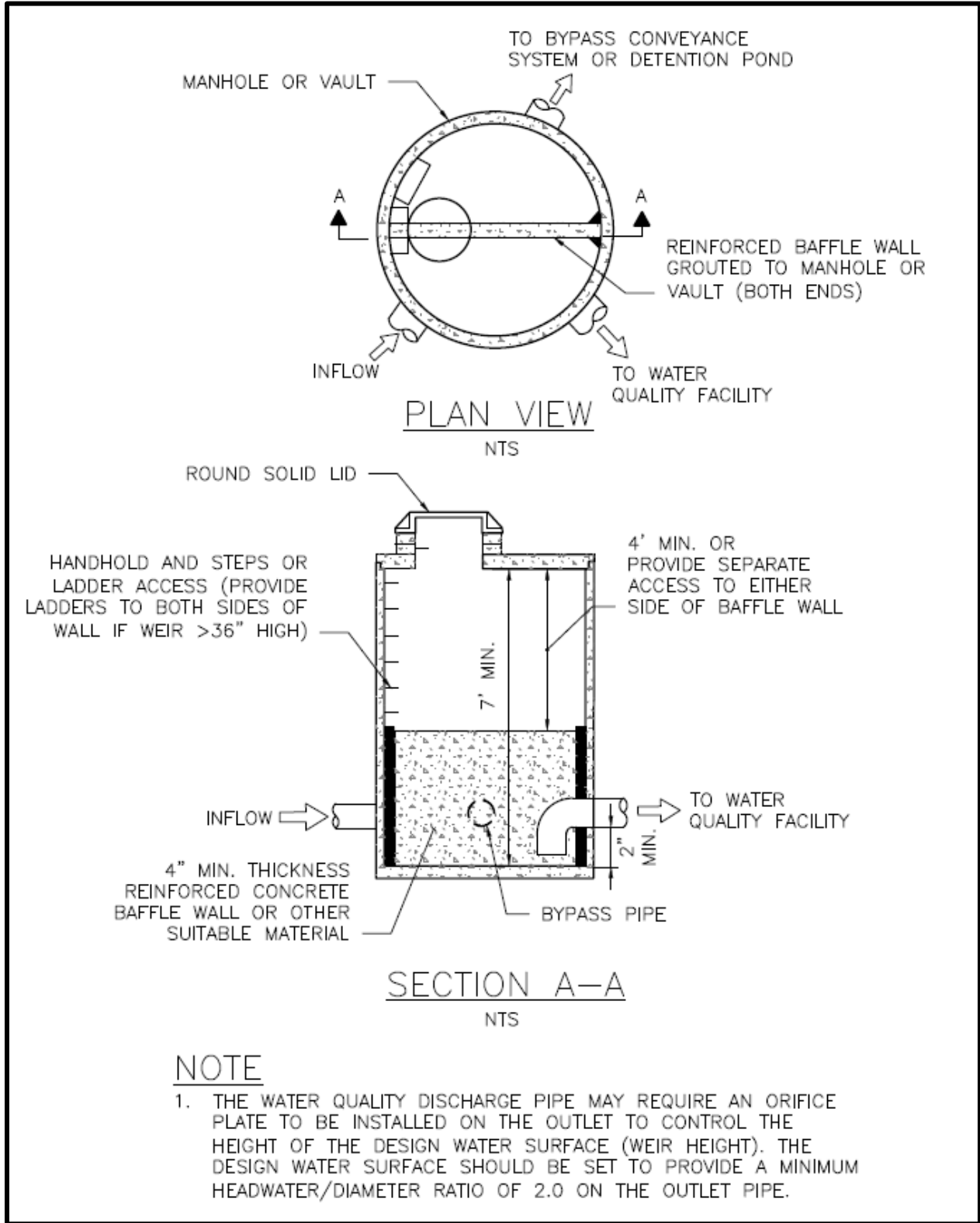

Figure E.5E-4. Flow Splitter Example A.

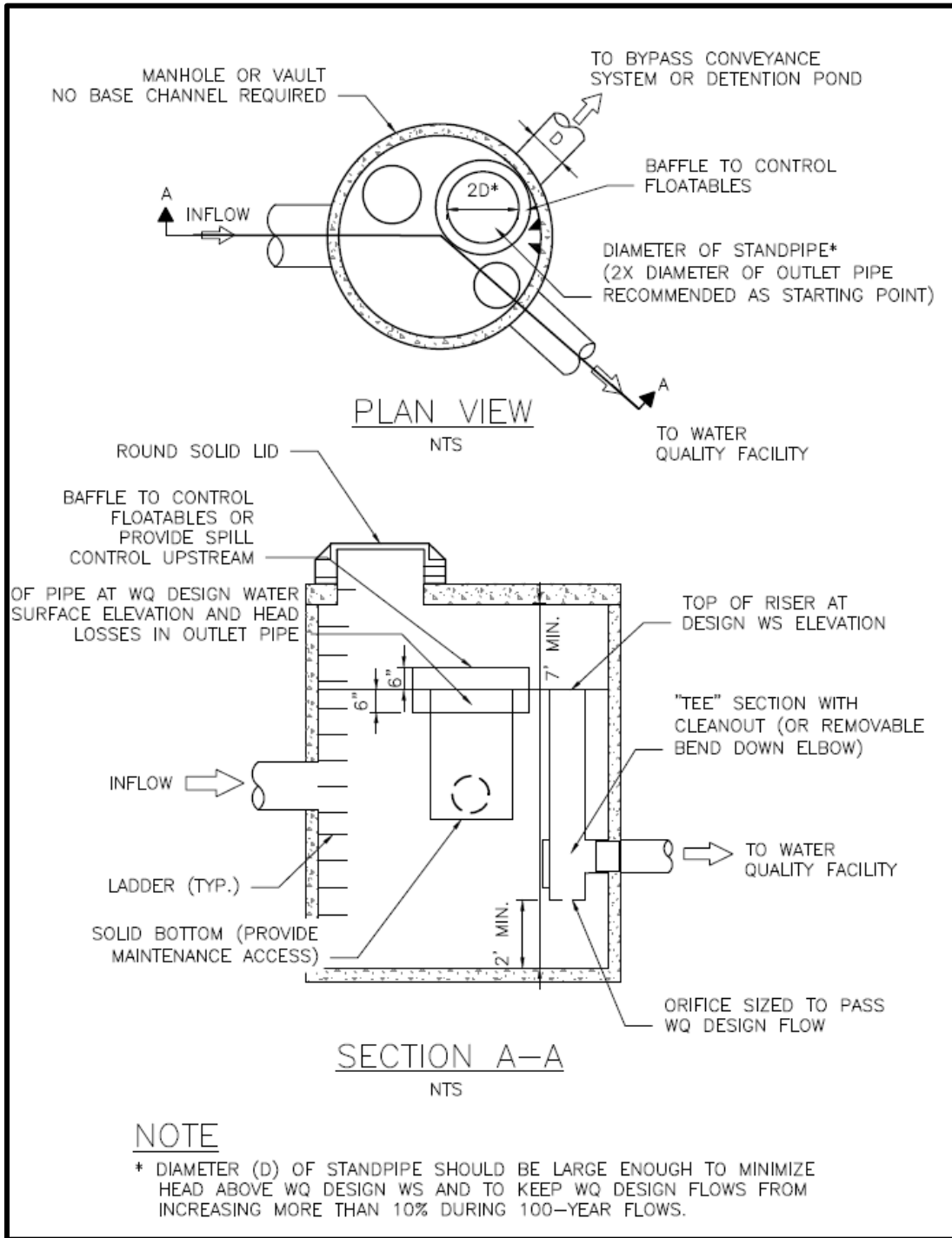

Figure E.6E-5. Flow Splitter Example B.

E-3. Flow Spreaders

Flow spreaders uniformly spread flows across the inflow portion of non-infiltrating BMPs (e.g., sand filter, biofiltration swale, or filter strip). There are five flow spreader options presented in this section:

- Option A – Anchored plate
- Option B – Concrete sump box
- Option C – Notched curb spreader
- Option D – Through-curb ports
- Option E – Interrupted curb

Options A through C can be used for spreading flows that are concentrated. Any one of these options can be used when spreading is required by the [facility-BMP](#) design criteria. Options A through C can also be used for unconcentrated flows, and in some cases shall be used, such as to correct for moderate grade changes along a filter strip.

Options D and E can only be used for flows that are already unconcentrated and enter a filter strip or continuous inflow biofiltration swale. Other flow spreader options are possible with prior approval by the Director.

General Design Criteria

- Where flow enters the flow spreader through a pipe, it is recommended that the pipe be submerged to the extent practical to dissipate energy as much as possible.
- For higher inflows (greater than 5 cfs for the 100-year storm), a Type 1 catch basin should be positioned in the spreader and the inflow pipe should enter the catch basin with flows exiting through the top grate [of the catch basin](#). The top of the grate should be lower than the [flow level](#) spreader plate, or if a notched spreader is used, lower than the bottom of the v-notches.

Option A – Anchored Plate

- An anchored plate flow spreader shall be preceded by a sump having a minimum depth of 8 inches and minimum width of 24 inches. If not otherwise stabilized, the sump area shall be lined to reduce erosion and to provide energy dissipation.
- The top surface of the flow spreader plate shall be level, projecting a minimum of 2 inches above the ground surface of the [water quality treatment facilityBMP](#), or v-notched with notches 6 to 10 inches on center and 1 to 6 inches deep (use shallower notches with closer spacing). Alternative designs may also be considered.
- A flow spreader plate shall extend horizontally beyond the bottom width of the [BMPfacility](#) to prevent water from eroding the side slope. The horizontal extent shall be such that the bank is protected for all flows up to the 100-year flow, or the maximum flow that will enter the [water quality treatment BMPfacility](#).
- Flow spreader plates shall be securely fixed in place.

- Flow spreader plates may be made of either wood, metal, fiberglass reinforced plastic, or other durable material. If wood, pressure treated 4- by 10-inch lumber or landscape timbers are acceptable.
- Anchor posts shall be 4-inch square concrete, tubular stainless steel, or other material resistant to decay. Refer to Volume V of the Stormwater Management Manual for Western Washington (SWMMWW) for an example of an anchored plate flow spreader.

Option B – Concrete Sump Box

- The wall of the downstream side of a rectangular concrete sump box shall be level and shall extend a minimum of 2 inches above the [inlet to the treatment BMP bed](#). This serves as a weir to spread the flows uniformly across the [BMP inlet bed](#).
- The downstream wall of a sump box shall have “wing walls” at both ends. Side walls and returns shall be slightly higher than the weir so that erosion of the side slope is minimized.
- Concrete for a sump box can be either cast-in-place or precast, but the bottom of the sump shall be reinforced with wire mesh for cast-in-place sumps [boxes](#).
- Sump boxes shall be placed over bases that consist of 4 inches of crushed rock, 5/8-inch minus to help assure the sump [box](#) remains level. Refer to Volume V of the SWMMWW for an example of a concrete sump box flow spreader.

Option C – Notched Curb Spreader

Notched curb spreader sections shall be ~~level and~~ made of extruded concrete laid side-by-side and level. Typically, five “teeth” per 4-foot section provides [good](#) spacing. The space between adjacent teeth forms a v-notch.

Option D – Through-Curb Ports

Unconcentrated flows from paved areas entering filter strips or continuous inflow biofiltration swales can use [through-curb](#) ports ([Option D](#)) or interrupted curbs (Option E) to allow flows to enter the [BMP strip or swale](#). [Through-c](#)urb ports use fabricated openings that [allow concrete curbing to be poured or extruded while still](#) provid[ing](#) an opening through the curb to admit water to the [BMP facility](#).

Openings in the curb shall be at regular intervals ~~and but~~ at least every 6 feet ~~(minimum)~~. The width of each ~~curb port~~ opening shall be a minimum of ~~11-8~~ inches [for non-right-of-way applications and a minimum of 10 inches in the right-of-way](#). Approximately 15 percent or more of the curb section length should be in open ports, and no port should discharge more than about 10 percent of the flow. Refer to Volume V of the SWMMWW for an example of a through-curb port flow spreader.

Option E – Interrupted Curb

Interrupted curbs are sections of curb placed to have gaps spaced at regular intervals along the total width (or length, depending on the [BMPfacility](#)) of the [treatmentfacility](#) area. At a minimum, gaps shall be every 6 feet to allow distribution of flows into the treatment [BMPfacility](#) before they become too concentrated. The opening shall be a minimum of [8 inches for non-right-of-way applications and a minimum of 10 inches in the right-of-way](#) ~~11 inches~~. As a general rule, no opening should discharge more than 10 percent of the overall flow entering the [BMPfacility](#).

E-4. Level Spreaders

Definition

A level spreader is constructed at zero percent grade and can be used to distribute concentrated runoff to sheet flow. Level spreaders can be used as either a temporary or a permanent BMP.

Purpose

To convert concentrated runoff to a thin layer of sheet flow to promote release onto a stable receiving area. For example, an existing vegetated area or a vegetated strip.

Condition Where Practice Applies

None identified for this BMP.

Planning Considerations

When properly constructed, the level spreader will significantly reduce the velocity of concentrated stormwater and spread it uniformly over a stabilized or undisturbed area.

Particular care shall be taken to ensure that the lower downslope side (or the lip) of the structure is level and on grade. If there are any depressions in the lip, flow will tend to concentrate at these points and erosion will occur, resulting in failure of the outlet. This problem may be avoided by using a grade board or a gravel lip over which the runoff shall flow when exiting the spreader. Regular maintenance is essential for this practice.

Level spreaders shall be constructed on undisturbed areas that are stabilized by existing vegetation, or areas that have been properly stabilized in accordance with the requirements of the Construction Stormwater and Erosion Control section of this manual (*Volume 2*), and where concentrated flows will be dissipated at zero percent grade (Figure [E.7E-6](#)).

Design Criteria

- The grade of the pipe and/or ditch for the last 20 feet before entering the level spreader shall be less than or equal to 1 percent, if feasible. If the grade is steeper, provide a flow dissipation device. The grade of the level spreader shall be zero percent to ensure uniform spreading of stormwater runoff.
- An 8-inch high gravel berm placed across the level lip shall consist of washed crushed rock, 2- to 4-inch or 0.75-inch to 1.5-inch size.
- The temporary level spreader length ~~shall~~ will be calculated by one of the following methods determined by estimating

- Single Event Hydrograph Method: The peak volumetric flow rate expected from the 10-year, 24-hour design storm (Q10) with a 10-minute time step, and selecting the appropriate length from Table E-1.
- Continuous Simulation Method:
 - The 10-year peak flow rate as determined ~~Alternatively, use the 10 percent annual probability flow (10-year recurrence interval) using a 5-minute time step, indicated by an approved continuous runoff model with a 15-minute time step or less.~~
 - ~~Use multiple spreaders for higher flows.~~ If the level spreader will be permanent, level spreader length will be determined by estimating the flow expected from the 25-year, 24-hour design storm (Q25). Alternatively, an approved continuous runoff model should be used to model the 25-year recurrence interval.
- Use multiple spreaders for higher flows.
 - The depth of the spreader as measured from the lip should be at least 8 inches and should be uniform across the entire length.
 - The area below the level spreader outlet shall be stabilized and have a slope of less than 11 percent.



Figure ~~E.7~~E.6. Level Spreader Prior to Backfill and Downstream Stabilization.

Table E.1. Spreader Length Based on 10-Year, 24-Hour Storm.

Q₁₀ in cfs	Minimum Length (in feet)
0 to 0.1	15
0.1 to 0.2	25
0.2 to 0.3	35
0.3 to 0.4	45
0.4 to 0.5	55

cfs = cubic feet per second

Q₁₀ = 10-year, 24-hour design storm

Maintenance

The spreader should be inspected regularly to ensure that it is functioning correctly. Do not place any material on [the level spreader](#) and prevent traffic from crossing [over the level spreader structure](#). If the [level spreader](#) is damaged, it ~~shall~~**must** be immediately repaired.

E-5. Pipe Slope Drains

Definition

A slope drain consists of a pipe extending from the top to the bottom of a cut or fill slope and discharging into a stabilized watercourse or a sediment trapping device or onto a stabilization area. It can also be used for water discharging from a flow control or treatment [facilityBMP](#), or to safely convey water past the toe of the slope. Pipe slope drains can be used as ~~either~~ a temporary ~~or a permanent~~ BMP.

Purpose

To ~~convey~~ carry concentrated runoff down steep slopes without causing gullies, channel erosion, or saturation of landslide-prone soils (Figure [E.8E-7](#)).

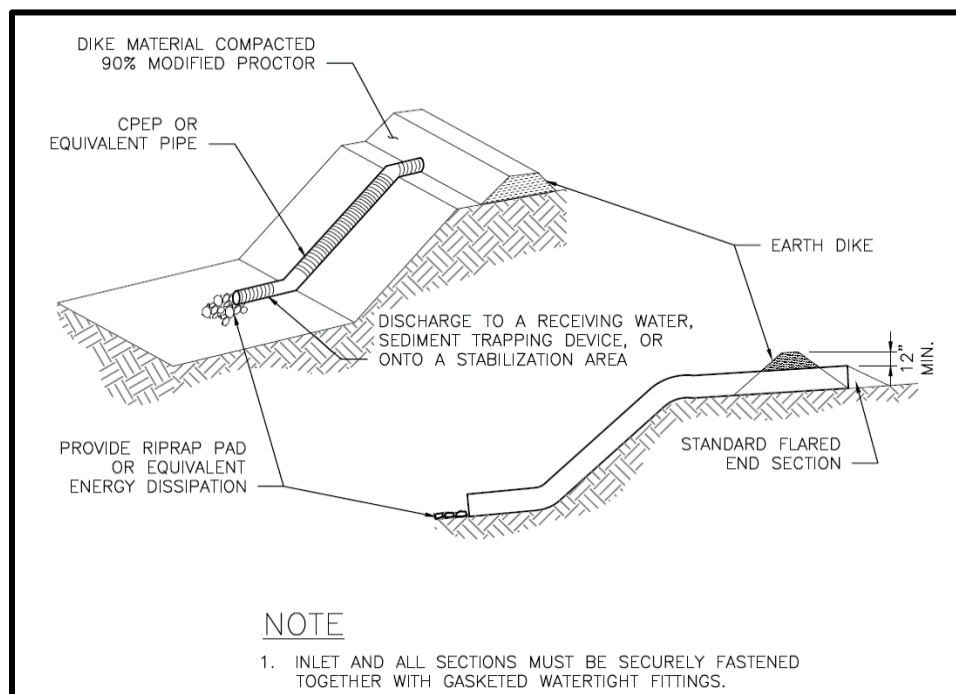

Figure [E.8E-7](#). Pipe Slope Drain Details.

Conditions Where Practice Applies

Pipe slope drains shall be used when conveying concentrated runoff down a steep slope has the potential to cause erosion.

Planning Considerations

There is often a lag between the time a cut or fill slope is completed and the time a permanent drainage system can be installed. During this period, the slope is usually not

stabilized and is particularly vulnerable to erosion. Temporary slope drains can provide valuable protection of exposed slopes until permanent drainage structures can be installed. The entrance section shall be securely entrenched, all connections shall be watertight, and the conduit shall be staked securely.

Additional protection requirements for steep slopes are included in the Environmentally Critical Area Ordinance (SMC, Section 25.09.180).

Design Criteria

- Permanent slope drains shall be designed by a licensed engineer and may have additional criteria for flow and water quality treatment requirements. Variations or alterations to the minimum BMP requirements outlined below require a licensed engineer's approval.
- Size the pipe to convey the projected flow. The capacity for temporary drains shall be sufficient to handle the flows calculated by one of the following methods:
 - Single Event Hydrograph Method: The peak volumetric flow rate calculated using a 10-year, 24-hour design storm peak flow with a 10-minute time step.
 - Continuous Simulation Method: Alternatively, use the 10 percent annual probability flow (10-year peak flow rate recurrence interval) using a 155-minute time step or less, indicated by an approved continuous runoff model.

The hydrologic analysis shall use the existing land cover condition for predicting flow rates from tributary areas outside the project limits. For tributary areas on the project site, the analysis shall use the temporary or permanent project land cover condition, whichever will produce the highest flow rates. If using WWHM, bare soil areas should be modeled as "landscaped area." Refer to *Appendix F* for additional information on stormwater modeling.

- Re-establish cover immediately on areas disturbed by installation.
- Ensure that the entrance area is stable and large enough to direct flow into the pipe.
- The entrance shall consist of a standard flared end section for culverts 12 inches and larger with a minimum 6-inch metal toe plate to prevent runoff from undercutting the pipe inlet. The slope of the entrance shall be at least 3 percent ~~(Figure E-8)~~.
- Pipe slope drain size should be no greater than 6 inches. Intercept flow frequently by using multiple pipe slope drains. Multiple pipes should be no closer than 10 feet.
- The soil around and under the pipe and entrance section shall be thoroughly compacted to prevent undercutting.
- The flared inlet section shall be securely connected to the slope drain and have watertight connecting bands.
- Slope drain sections shall be securely fastened together and have gasketed watertight fittings, and be securely anchored into the soil.
- Thrust blocks should be installed any time 90 degree bends are utilized. Depending on size of pipe and flow, these can be constructed with sand bags, straw bales staked in place, "t" posts and wire, or ecology blocks.

- Pipe needs to be secured along its full length to prevent movement. This can be done with steel “t” posts and wire. Install a post ~~is installed~~ on each side of the pipe and wire the pipe ~~is wired~~ to them. This should be done every 10 to 20 feet of pipe length, depending on the size of the pipe and quantity of water diverted.
- Earth dikes shall be used to direct runoff into a pipe slope drain. The height of the dike shall be at least 12 inches higher at all points than the top of the inlet pipe.
- The area below the outlet shall be stabilized with a riprap apron (refer to *Section E-6* for outlet protection).
- If the pipe slope drain is conveying sediment-laden water, direct all flows into the sediment trapping ~~facility~~BMP.
- Refer to the City of Seattle Standard Specifications for all material specifications (<http://www.seattle.gov/util/Engineering/StandardSpecsPlans/index.htm>).

Maintenance

- Check inlet and outlet points regularly, especially after heavy storms. The inlet should be free of undercutting, and no water should be going around the point of entry. If there are problems, reinforce the headwall with compacted earth or sand bags. The outlet point should be free of erosion and installed with appropriate outlet protection.
- For permanent installations, inspect the pipe periodically for vandalism and physical distress such as slides and wind-throw. Clean the pipe and outlet structure at the completion of construction.
- Normally the pipe slope is so steep that clogging is not a problem with smooth wall pipe; however, debris may become lodged in the pipe or at the inlet.

E-6. Outlet Protection

Definition

Energy dissipating materials or devices placed at concentrated flow outlets, such as the outlets of pipes or paved channel sections. Outlet protection can be used as either a temporary or a permanent BMP.

Purpose

To prevent scour at stormwater outlets, and to minimize the potential for downstream erosion by reducing the velocity of concentrated stormwater flows.

Condition Where Practice Applies

Outlet protection is required wherever concentrated runoff could cause scour or erosion.

Planning Considerations

None identified for this BMP.

Design Criteria

- Permanent BMPs shall be designed by a licensed engineer and may have additional criteria for flow and water quality treatment requirements. Variations and/or alterations to the minimum BMP requirements require a licensed engineer's approval.
- ~~Protect At~~ culvert outlets, ~~protect~~ from erosion by rock lining the downstream and extending up the channel sides above the maximum ~~tailwater~~tail water elevation.
- Standard wing walls, tapered outlets, and paved channels should also be considered when appropriate for permanent ~~culvert~~ outlet protection.
- ~~Organic or synthetic erosion blankets, with or without vegetation, are usually more effective than rock, less expensive, and easier to install. However, materials may be chosen using manufacturer product specifications.~~
- With low flows, grass-lined channels (refer to Ecology BMP C201) vegetation (including seed) can be an effective alternative for lining material.
- Blankets (refer to BMP E1.15: Mulching, Matting, and Compost Blankets in Volume 2) or riprap channel lining (refer to Ecology BMP C202) Riprap outlet protection may also appropriate in some situations provide suitable options for lining materials.
- The following guidelines shall be used for outlet protection with riprap:
 - For outlets at the base of steep slope pipes (pipe slopes greater than 10 percent), use an engineered energy dissipater

- ~~shall be used with~~ filter fabric or erosion control blankets should be used under riprap to prevent scour and channel erosion. [Refer to BMP E1.15: Mulching, Matting, and Compost Blankets in Volume 2.](#)

Maintenance

Check for evidence of erosion, scour, or channeling. Rock may need to be added if sediment builds up in the pore spaces of the outlet pad. Vegetation, erosion control blankets, or rock pads may need replacement. Partial blocking of an outlet with a protective measure is not allowed unless designed by a licensed engineer.

E-7. Facility Liners

Liners discussed in this section are intended to reduce the likelihood that pollutants in stormwater will reach groundwater when ~~runoff~~ treatment ~~facilities~~ ~~BMPs~~ are constructed ~~or protect surrounding areas from seepage when necessary~~. In addition to groundwater protection considerations, some facility types require permanent standing water for proper functioning. An example is the first cell of a wet pond.

There are ~~threetwo~~ types of ~~facility~~ liners:

1. **Treatment liners** amend the soil with materials that treat stormwater before it reaches more freely draining soils. They have slow rates of infiltration, generally less than 2.4 inches per hour, but not as slow as low permeability liners. Treatment liners may use in-place native soils or imported soils, provided that the design criteria outlined below are met.
2. **Low permeability liners** reduce infiltration to a very slow rate, generally less than 0.02 inches per hour. These types of liners are often used for industrial or commercial sites with a potential for high pollutant loading in the stormwater runoff. Low permeability liners may be constructed from compacted till, clay, ~~geomembrane~~, or concrete. Till liners are preferred because of their general resilience and ease of maintenance.
3. **Impermeable liners prevent the transmission of water between the BMP and native soils.** Impermeable liners shall be used when BMPs are constructed in areas where infiltration is not permitted or is discouraged (e.g., landslide-prone areas or in contaminated soils). Impermeable liners shall be constructed from geomembrane.

~~Liners may also be required in areas where infiltration is not permitted (e.g., landslide-prone areas).~~

Table E-2 shows the type of liner required for use with various ~~runoff~~ treatment ~~facilities~~ ~~BMPs~~ (detention, non-infiltrating, and pretreatment BMPs). Other liner configurations may be used with prior approval from the Director.

Liners shall be placed over the bottom and/or sides of the ~~facility~~ ~~BMP~~ as indicated in Table E-2.

When placing a liner for water quality treatment, Areas above the treatment volume that are required to pass flows greater than the water quality treatment flow (or volume) need not be lined. However, the lining shall be extended to the top of the interior side slope and be anchored if it cannot be permanently secured by other means.

Table E.2. Lining Types Required by BMP Type.

Facility/BMP	Area to be Lined	Type of Liner Required
Presettling basin	Bottom and sides	Low permeability liner, or treatment liner, <u>or impermeable liner</u>
Wet pond	First cell: bottom and sides to WQ design water surface	Low permeability liner, or treatment liner, <u>or impermeable liner</u>
	Second cell: bottom and sides to WQ design water surface	Treatment liner
Combined detention/non-infiltrating BMP	First cell: bottom and sides to WQ design water surface	Low permeability liner, or treatment liner, <u>or impermeable liner</u>
	Second cell: bottom and sides to WQ design water surface	Treatment liner
Stormwater wetland	Bottom and sides, both cells	Low permeability liner <u>or impermeable liner</u>
Sand filter basin	Required if over a critical aquifer recharge area, otherwise not required. Refer to <i>Volume 3, Section 5.8.5</i> .	Low permeability <u>line</u> , or treatment liner, <u>or impermeable liner</u>
Sand filter vault	Not applicable	No liner needed
Linear sand filter	Not applicable if in vault	No liner needed
	Bottom and sides of presettling cell if not in vault	Low permeability <u>liner</u> , or treatment liner, <u>or impermeable liner</u>
Media filter (in vault)	Not applicable	No liner needed
Wet vault	Not applicable	No liner needed
Non-infiltrating bioretention	Bottom and sides	Low permeability liner <u>or impermeable liner</u>
<u>Open bottom or open sided detention products (e.g., arch pipe, modular plastic tanks, etc.)</u>	<u>Bottom and sides</u>	<u>Low permeability liner or impermeable liner</u>

Notes

- ^a The Director may approve native soils as a low permeability liner based on measured infiltration rates and the recommendation of a licensed professional.
- ^b The Director may also require impermeable~~low permeability~~ liner based on infiltration setbacks or site constraints.

Design Criteria for Treatment Liners

This section presents the design criteria for treatment liners.

- A 2-foot-thick layer of soil with a minimum organic content of 1 percent AND a minimum cation exchange capacity (CEC) of 5 milliequivalents/100 grams can be used as a treatment layer beneath a water quality or detention facility/BMP.
- To demonstrate that in-place soils meet the above criteria, one sample per 1,000 square feet of facility/BMP area shall be tested. Each sample shall be a composite of subsamples collected throughout the depth of the treatment layer (usually 2 to 6 feet below the expected BMP invert).

- Typically, side wall seepage is not a concern if the seepage flows through the same stratum as the bottom of the treatment BMP. However, if the treatment soil is an engineered soil or has very low permeability, the potential to bypass the treatment soil through the side walls may be significant. In those cases, the treatment BMP side walls should be lined with at least 18 inches of treatment soil, as described above, to prevent untreated seepage. This lesser soil thickness is based on unsaturated flow as a result of alternating wet-dry periods. [Approved continuous simulation models must be run using the “No infiltration” option through the sidewalls if one sidewall is impervious unless the model can limit infiltration only to the unlined portion of the perimeter.](#)
- Organic content shall be measured on a dry weight basis using ASTM D2974.
- Cation exchange capacity (CEC) shall be tested using EPA laboratory method 9081.
- Certification by a soils testing laboratory that imported soil meets the organic content and CEC criteria above shall be provided to the City.
- ~~Animal manures used in treatment soil layers shall be sterilized because of potential for bacterial contamination of the groundwater.~~
- [The liner shall extend vertically to the water quality design water surface elevation plus 6 inches at the minimum.](#)

Design Criteria for Low Permeability Liners

This section presents the design criteria for each of the following four low permeability liner options: compacted till liners, clay liners, [geomembrane liners](#), and concrete liners. For low permeability liners, the following criteria apply:

- Where the seasonal high groundwater elevation is likely to contact a low permeability liner, liner buoyancy may be a concern. In these instances, use of a low permeability liner shall be designed by a geotechnical engineer.
- [Where grass is planted over a low permeability liner per the *facility-BMP* design, a minimum of 6 inches of topsoil of sufficient organic content and depth or compost-amended native soil shall be placed over the liner in the area to be planted. Native underlying soils may be suitable for planting if amended per Soil Amendment BMP requirements in *Volume 3, Section 5.1*. Twelve inches of cover is preferred.](#)
- [Low permeability liners shall extend vertically to the design water surface elevation plus 6 inches at a minimum. For bioretention, the design water surface elevation shall be the 25-year water surface elevation.](#)

Compacted Till Liners

- Liner thickness shall be 18 inches after compaction.
- Soil shall be compacted to 95 percent minimum dry density, modified proctor method (ASTM D-1557).
- A different depth and density sufficient to slow the infiltration rate to 2.4×10^{-5} inches per minute may also be used instead of the above criteria if designed by a geotechnical engineer.
- Soil shall be placed in maximum 6-inch lifts.

- Soils shall meet the gradation outlined in Table E-3 unless otherwise designed by a geotechnical engineer.

Table E.3. Compacted Till Liners.

Sieve Size	Percent Passing
6-inch	100
4-inch	90
#4	70 – 100
#200	20

Clay Liners

- Liner thickness shall be 12 inches after compaction.
- Clay shall be compacted to 95 percent minimum dry density, modified proctor method (ASTM D-1557).
- A different depth and density sufficient to slow the infiltration rate to 2.4×10^{-5} inches per minute may also be used instead of the above criteria, if designed by a geotechnical engineer and approved by the Director.
- Plasticity index shall not be less than 15 percent (ASTM D-423, D-424).
- Liquid limit of clay shall not be less than 30 percent (ASTM D-2216).
- Clay particles passing shall not be less than 30 percent (ASTM D-422).
- The slope of clay liners shall be restricted to 3H:1V for all areas requiring soil cover; otherwise, the soil layer shall be stabilized by another method so that soil slippage into the [facility-BMP](#) does not occur. Any alternative soil stabilization method shall take maintenance access into consideration.

Concrete Liners

- Concrete liners may also be used for sedimentation chambers, ~~and~~ for sedimentation and filtration basins less than 1,000 square feet in area, [and non-infiltrating bioretention](#). Concrete shall be 5-inch thick Class 3000 or better and shall be reinforced by steel wire mesh. The steel wire mesh shall be 6 gage wire or larger and 6-inch by 6-inch mesh or smaller. An "Ordinary Surface Finish" is required per City of Seattle Standard Specification 6-02.3(14). When the underlying soil is clay or has an unconfined compressive strength of 0.25 ton per square foot or less, the concrete shall have a minimum 6-inch compacted aggregate base consisting of coarse sand and river stone, crushed stone or equivalent with diameter of 0.75 to 1 inch. Where visible, the concrete shall be inspected annually and all cracks shall be sealed.
- Portland cement liners are allowed irrespective of [facility-BMP](#) size, and shotcrete may be used on slopes. However, specifications shall be designed by a licensed engineer who certifies the liner against cracking or losing water retention ability under expected conditions of operation, including [facility-BMP](#) maintenance operations. Weight of maintenance equipment can be up to 80,000 pounds when fully loaded.
- Asphalt concrete may not be used for liners due to its permeability to many organic pollutants.

- If grass is to be grown over a concrete liner, slopes shall be no steeper than 5H:1V to prevent the top dressing material from slipping. Textured liners may be used on slopes up to 3H:1V upon recommended design by a geotechnical engineer that the top dressing will be stable for all site conditions, including maintenance.

Design Criteria for Impermeable Liners

Geomembrane Liners

- Geomembrane liners shall be ultraviolet (UV) light resistant and have a minimum thickness of 30 mils. A thickness of 40 mils shall be used in areas of maintenance access or where heavy machinery will be operated over the membrane.
- The geomembrane fabric shall be protected from puncture, tearing, and abrasion by installing geotextile fabric on the top of and beneath~~bottom of~~ the geomembrane. The geotextile fabric shall have a high survivability per the WSDOT Standard Specifications Section 9-33 Construction Geotextile. Equivalent methods for protecting the geomembrane liner may be permitted, subject to approval by Director. Equivalency will be based on the ability of the fabric to protect the geomembrane from puncture, tearing, and abrasion.
- Geomembranes shall be bedded according to the manufacturer's recommendations.
- Liners shall be covered with minimum of 12 inches of top dressing~~forming the bottom and sides of the water quality treatment facility, except for linear sand filters~~. Top dressing shall include~~consist of~~ 6 inches of crushed rock immediately over the liner covered with 6 inches of topsoil of sufficient organic content and depth or compost-amended native soil. The rock layer is to mark the location of the liner for future maintenance operations. As an alternative to crushed rock, 12 inches of native soil may be used if orange plastic "safety fencing" or another highly-visible, continuous marker may be~~is~~ embedded 6 inches above the membrane to alert maintenance workers of the liner below.
- If possible, liners should be of a contrasting color so that maintenance workers are aware of any areas where a liner may have become exposed when maintaining the facility~~BMP~~.
- Non-textured geomembrane liners shall not be used on slopes steeper than 5H:1V to prevent the top dressing material from slipping. Textured liners may be used on slopes up to 3H:1V upon design by a geotechnical engineer that the top dressing will be stable for all site conditions, including maintenance.
- Geomembrane liners used to control seepage shall be joined using heat-fusion or equivalent, and include boots around all pipe and structure penetrations.
- Geomembrane liners shall extend vertically to the design water surface elevation plus 6 inches at a minimum. For bioretention, the design water surface elevation shall be the 25-year water surface elevation.

E-8. Geotextiles

The following recommended applications are provided courtesy of Tony Allen (Geotechnical Engineer-WSDOT) with references provided to the relevant tables in the City of Seattle Standard Specifications:

- For sand filter drain strip between the sand and the drain rock or gravel layers, use Geotextile Properties for Underground Drainage, moderate survivability, Class A, from Tables 1 and 2 in the City of Seattle Standard Specifications 9-37.
- For sand filter matting located immediately above the impermeable liner and below the drains, the function of the geotextile is to protect the impermeable liner by acting as a cushion. The specification provided in Table 4 in the City of Seattle Standard Specifications 9-37 shall be used to specify survivability properties for the liner protection application. Table 2 in the City of Seattle Standard Specifications 9-37, Class C shall be used for filtration properties. Only nonwoven geotextiles are appropriate for the liner protection application.
- For infiltration [BMPs drains](#), use Geotextile for Underground Drainage, low survivability, Class C, from Tables 1 and 2 in the City of Seattle Standard Specifications 9-37.
- For a sand bed cover, a geotextile fabric is placed exposed on top of the sand layer to trap debris brought in by the stormwater and to protect the sand, facilitating easy cleaning of the surface of the sand layer. A polyethylene or polypropylene geonet shall be used in lieu of geotextile fabric. The geonet material shall have high UV resistance (90 percent or more strength retained after 500 hours in the weatherometer, ASTM D4355), and high permittivity (ASTM D4491, 0.8 sec⁻¹ or more) and percent open area (CWO-22125, 10 percent or more). Tensile strength shall be on the order of 200 pounds grab (ASTM D4632) or more.
- [For above and below a geomembrane liner, the geotextile fabric shall be Geotextile for Separation per the COS Standard Specifications Section 9-37 Construction Geotextile.](#)

E-9. Plant Lists for Bioretention, Biofiltration Swales, Sand Filters, and Wet Ponds

The following plant lists were developed as a guide for bioretention (infiltrating and non-infiltrating), biofiltration swales, sand filters, and wet ponds. For information regarding planting for other BMPs, refer to *Volume 3, Chapter 5*. More stringent requirements have been developed for [facilities-BMPs](#) sited in the right-of-way and can be found in the Seattle Right-of-Way Improvements Manual.

[The following design principles should be considered during plant selection:](#)

- [Select plants to minimize irrigation and maintenance needs. Coordinate planting design, whenever possible, with maintenance staff.](#)
- [Where appropriate, use regionally native species.](#)
- [Design a planting plan with a goal of achieving a minimum of 80 percent evergreen groundcover. Evergreen groundcover helps trap sediment and protects soil and infiltration rates during the wet season.](#)
- [Consider biodiversity of species, including a minimum of three to five species for planting plans for small BMPs, and increasing species diversity where possible. Species and genetic diversity increase resilience and the ability of a BMP to adapt during varying site conditions.](#)
- [Incorporate pollinator, bird, and wildlife species into planting plans where possible. Maximize various seasonal habitat function. For example, flowering plants should bloom three of the four seasons. Planting plans for BMPs adjacent to natural areas should include trees, shrubs, and groundcover that provide habitat value and support.](#)

Bioretention

The Seattle Right-of-Way Improvements Manual establishes height limits for non-street tree plantings in rights-of-way. Maximum plant height within 30 feet of an intersection (as measured from the corner of the curb) is 24 inches. Elsewhere in the right-of-way, plantings are allowed to be 30 inches with the exception of accent shrubs as directed.

The following planting zone codes apply to Tables E.4 through E.19:

- Zone 1: designation for plants that are used for water quality in the bottoms of ~~the~~ bioretention [facilitiesBMPs](#)
- Zone 2: designation for plants that are used for water quality in the lower slopes/wetted/ponded area of ~~the~~ bioretention [BMPsfacilities](#)
- Zone 3: species appropriate for planting at the tops and upper slopes ~~of the~~ of bioretention [BMPsareas](#) that are used as a border and as accents along the sidewalk, including vertical and accent plants and trees
- Zone 4: low, durable plants (under 24 inches) that are used in sight clearance areas or as accents at the edge of the [facilityBMP](#)

- Zone 5: designation for steppable plants used in the crossing zones and access areas along the curb – these plants may need to tolerate foot traffic, depending on their location

The following operations and maintenance/special needs code (O&M code) apply to Tables E.4 through E.10:

- A = Cut back perennials to 3 inches above ground in fall (October/November).
- B = Leave foliage and seedheads for winter interest and cut back if foliage collapses. Cut back in spring (Mid-January to Mid-March) before new growth emerges.
- C = Hand-rake in spring (Mid-January to Mid-March) before new growth emerges. Cut back to ground or thin every 2 to 3 years as needed.
- DS = Deadhead perennials in spring/summer to encourage reblooming and for neater appearance. Deadheading not required for function.
- DF = Deadhead perennials in fall for neater appearance and to prevent resowing. Deadheading not required for function.
- E = Cut back or prune of over sidewalk or clear zones. Remove deadwood anytime fall to spring.
- F = May need replacing every 5+/- years. (Replacement not required if vegetation coverage meets requirements)
- G = May need dividing every few years. Reasons for division include dieback in center and to increase coverage.

Table E.4. Part Shade List.

EG	DT	NWN	Height from Ground	Scientific Name	Common Name	Planting Zone	Suggested Size/ Spacing	Urban Frontage	Exposure	Design Comments	O&M Code	Additional O&M Comments
SEMI			<24"	<i>Abelia x grandiflora</i> 'Prostrata'	Prostrate white abelia	3, 4	1 Gal./30" o.c.	UF	☀, ∅		E	
	DT		18"–30"	<i>Aster divaricatus</i>	White wood aster	3	1 Gal./24" o.c.		∅		B	
			<24"	<i>Carex elata</i> 'Bowles Golden'	Bowles Golden sedge	1, 2	10 Cu. In. Plug/ 9" o.c.	UF	☀, ∅	Limit to areas of approx. 36"x36"	B	
EG			<24"	<i>Carex laxiculmis</i> 'Hobb'	Bunny Blue sedge	1, 2	10 Cu. In. Plug/ 9" o.c.	UF	∅		C	
EG	DT	NWN	24"–48"+	<i>Carex obnupta</i>	Slough sedge	1, 2	10 Cu. In. Plug/ 9" o.c.		☀, ∅	Do not intermix with other emergents. Do not plant near intersections. Drought tolerant wetland native.	C	Can be sheared more frequently if overcrowding other occurs. May require supplementary irrigation during prolonged dry periods.
		NWN	24"–36"	<i>Carex stipata</i>	Beaked sedge	1, 2	10 Cu. In. Plug/ 9" o.c.	UF	☀, ∅	Wetland native species. Limit to areas of approx. 36"x36"	B	May require supplementary irrigation during prolonged dry periods. Will die out if mowed or trimmed too regularly.
EG			24"–30"	<i>Carex testacea</i> or <i>dispacea</i>	Orange New Zealand or Autumn Sedge	1, 2	10 Cu. In. Plug/ 9" o.c.	UF	☀, ∅		C	

Table E.4 (continued). Part Shade List.

EG	DT	NWN	Height from Ground	Scientific Name	Common Name	Planting Zone	Suggested Size/ Spacing	Urban Frontage	Exposure	Design Comments	O&M Code	Additional O&M Comments
	DT		24"–36"	<i>Cornus sericea</i> 'Kelseyii'	Kelsey redstem dogwood	1, 2, 3	2 Gal./30" o.c.	UF	☀, ∅		E	Stems fragile until established.
		NWN	24"–40"	<i>Deschampsia caespitosa</i>	Tufted Hair Grass	1, 2	10 Cu. In. Plug/ 9" o.c.		☀, ∅	Native facultative species; does well in wet and dry conditions. Limit to areas of approx. 36"x36"	B	LOS A: For neater appearance, trim seedheads.
			<24"	<i>Deschampsia flexuosa</i> 'Aurea'	Golden crinkled hair grass	1, 2	10 Cu. In. Plug/ 9" o.c.	UF	☀, ∅	Limit to areas of approx. 36"x36"	B	LOS A: For neater appearance, trim seedheads.
			24"	<i>Fuchsia magellanica</i> 'Aurea'	Dwarf Hardy Fuchsia	3, 4	2 Gal./30" o.c.	UF	∅		E	
			<24"	<i>Galanthus elwesii</i>	Giant Snowdrop	3, 4	Bulb	UF	☀, ∅	Prefers part shade. May be short-lived if too hot.	F	
EG	DT	NWN	24"–36"+	<i>Gaultheria shallon</i>	Salal	3	1 Gal./24" o.c.	UF	☀, ∅		E	If height is a problem, Salal can be sheared with hedge trimmer.
EG			<24"	<i>Geum flore-plena</i> 'Blazing Sunset'	Blazing Sunset Avens	3, 4	1 Gal./10" o.c.	UF	☀, ∅		DS	
			24"–36"	<i>Iris pallida</i> 'Variegata'	Variegated sweet iris	3	1 Gal./18" o.c.	UF	☀, ∅		A	

Table E.4 (continued). Part Shade List.

EG	DT	NWN	Height from Ground	Scientific Name	Common Name	Planting Zone	Suggested Size/ Spacing	Urban Frontage	Exposure	Design Comments	O&M Code	Additional O&M Comments
EG	DR	NWN	<24"	<i>Mahonia repens</i>	Creeping Oregon holly-grape	3, 4	1 Gal./18" o.c.	UF	☀, ∅		E	
EG	DR	NWN	24"–36"	<i>Polystichum munitum</i>	Western swordfern	3	2 Gal./24" o.c.	UF	∅	Limit to group of 3	B	Cut back before fronds appear.
EG	DT		24"–36"	<i>Prunus laurocerasus</i> 'Mount Vernon'	Mount Vernon cherry laurel	3	2 Gal./24" o.c.	UF	☀, ∅		E	
EG			36"	<i>Rhododendron</i> Yak Hybrids, such as 'Ken Janeck'	Yak Hybrid	3	2 Gal./24" o.c.	UF	☀, ∅	Several other Yak hybrids stay low and neat	E	LOS A: May produce more flowers if pruned and/or deadheaded after blooming.
EG	DT		<24"	<i>Sarcococca hookeriana humilis</i>	Himalayan Sweet Box	3	2 Gal./24" o.c.	UF	∅	Winter fragrance	E	
EG			30"	<i>Taxus</i> 'Emerald Spreader'	Emerald Spreader Yew	3	2 Gal./24" o.c.	UF	☀, ∅		E	
		NWN	<24"	<i>Tolmiea menziesii</i>	Youth on Age	1, 2, 3	1 Gal./10" o.c.		∅		G	
EG	DT		<24"	<i>Veronica liwanensis</i>	Speedwell	3, 4, 5	4" Pot/12" o.c.	UF	☀, ∅		E	LOS A: Cut back for neater appearance.

EG = Evergreen

SEMI = Semi-evergreen

DT = Drought Tolerant

DR = Drought Resistant

NWN = Northwest Natives or Cultivars

UF = Urban Frontage (Mixed Use/Commercial) appropriate plants

☀ = Full Sun

∅ = Part Sun/Part Shade

LOS = Level of Service

Table E.5. Sun List.

EG	DT	NWN	Height from Ground	Scientific Name	Common Name	Planting Zone	Suggested Size/ Spacing	Urban Frontage	Exposure	Design Comments	O&M Code	Additional O&M Comments
SEMI			<24"	<i>Abelia x grandiflora</i> 'Prostrata'	Prostrate white abelia	3, 4	1 Gal./30" o.c.	UF	☀, ∅		E	
	DT		<24"	<i>Aster novi-belgii</i> 'Wood's Blue'	Wood's Blue New York Aster	3	1 Gal./18" o.c.	UF	☀		B, G	
			24"–36"	<i>Carex muskingumensis</i>	Palm sedge	1, 2	10 Cu. In. Plug/ 9" o.c.	UF	☀, ∅	Limit to areas of approx. 36"x36"	B	
			24"–36"	<i>Carex elata</i> 'Bowles Golden'	Bowles Golden Sedge	1, 2, 3	10 Cu. In. Plug/ 9" o.c.	UF	☀, ∅	Limit to areas of approx. 36"x36"	B	
			24"–36"+	<i>Carex grayi</i>	Gray's sedge	1, 2	10 Cu. In. Plug/ 9" o.c.	UF	☀, ∅	Limit to areas of approx. 36"x36"	B	
		NWN	24"–36"	<i>Carex stipata</i>	Beaked sedge	1, 2	10 Cu. In. Plug/ 9" o.c.	UF	☀, ∅	Wetland native species Limit to areas of approx. 36"x36"	B	May require supplementary irrigation during prolonged dry periods. Will die out if mowed or trimmed to regularly.
EG			24"–30"	<i>Carex testacea</i> or <i>dispacea</i>	Orange New Zealand or Autumn Sedge	1, 2, 3	10 Cu. In. Plug/ 9" o.c.	UF	☀, ∅		C	

Table E.5 (continued). Sun List.

EG	DT	NWN	Height from Ground	Scientific Name	Common Name	Planting Zone	Suggested Size/ Spacing	Urban Frontage	Exposure	Design Comments	O&M Code	Additional O&M Comments
	DT		24"–36"	<i>Caryopteris incana</i> 'Sunshine Blue'	Sunshine Blue Bluebeard	3, 4	1 Gal./18" o.c.	UF	☀		B OR DF	Cut back to about 18" above the ground or by half in early spring after new leaves are visible
	DT	NWN	24"–30"	<i>Cornus sericea</i> 'Kelseyii'	Kelsey redstem dogwood	1, 2, 3	2 Gal./30" o.c.	UF	☀, ∅		E	Stems fragile until established.
		NWN	24"–40"	<i>Deschampsia caespitosa</i>	Tufted Hair Grass	1, 2	10 Cu. In. Plug/ 9" o.c.		☀, ∅	Native facultative species: does well in wet and dry conditions. Limit to areas of approx. 36"x36"	B	LOS A: For neater appearance, trim seedheads.
			<24"	<i>Deschampsia flexuosa</i> 'Aurea'	Golden crinkled hair grass	1, 2	10 Cu. In. Plug/ 9" o.c.	UF	☀, ∅	Limit to areas of approx. 36"x36"	B	LOS A: For neater appearance, trim seedheads.
	DT		24"–36"	<i>Echinacea purpurea</i>	Coneflower	3	1 Gal./18" o.c.	UF	☀		B	LOS A: For neater appearance, deadhead.
EG	DT	NWN	24"–36"+	<i>Gaultheria shallon</i>	Salal	3	1 Gal./24" o.c.	UF	☀, ∅		E	If height is a problem, Salal can be sheared with hedge trimmer.

Table E.5 (continued). Sun List.

EG	DT	NWN	Height from Ground	Scientific Name	Common Name	Planting Zone	Suggested Size/ Spacing	Urban Frontage	Exposure	Design Comments	O&M Code	Additional O&M Comments
EG	DT		24"–36"	<i>Hebe</i> 'Red Edge'	Red Edge Hebe	3, 4	1 Gal./24" o.c.		☀		E	
	DT		<24"	<i>Hemerocallis</i> – Later Flowering Varieties	Later Flowering Daylily varieties	3, 4	1 Gal./15" o.c.	UF	☀, ∅	Later flowering varieties are not as susceptible to Daylily gall midge.	A	LOS A: For neater appearance, deadhead.
EG	DT		<24"	<i>Geranium x cantabrigiense</i> 'Cambridge'	Perennial Geranium	3, 4	1 Gal./15" o.c.	UF	☀, ∅		B	
SEMI	DT		<24"	<i>Helianthemum</i> 'Henfield Brilliant'	Sunrose	3, 4	1 Gal./10" o.c.	UF	☀		B	
EG	DT		24"–36"	<i>Helictotrichon sempervirens</i>	Blue oat grass	3	1 Gal./18" o.c.	UF	☀		C	
EG	DT		<24"	<i>Ilex x 'Mondo'</i>	Little Rascal Holly	3, 4	1 Gal./18" o.c.	UF	☀, ∅		E	
EG	DT	NWN	<24"	<i>Iris douglasiana</i>	Pacific Coast Iris	3, 4	1 Gal./18" o.c.	UF	☀	Many colors available.	G	LOS A: For neater appearance, cut back dead leaves and flower stalks.

Table E.5 (continued). Sun List.

EG	DT	NWN	Height from Ground	Scientific Name	Common Name	Planting Zone	Suggested Size/ Spacing	Urban Frontage	Exposure	Design Comments	O&M Code	Additional O&M Comments
SEMI	DT	NWN	<24"	<i>Iris missouriensis</i>	Rocky Mountain Iris	1, 2	1 Gal./12" o.c.	UF	☀		G	<p>May require supplementary irrigation during prolonged dry periods.</p> <p>LOS A: For neater appearance, cut back dead leaves and flower stalks.</p>
			24"–36"	<i>Iris sibirica</i> cultivars such as 'Bennerup Blue'	Siberian Iris	1, 2, 3	1 Gal./18" o.c.	UF			G	<p>LOS A: For neater appearance, cut back dead leaves and flower stalks.</p>
EG	DT	NWN	<24"	<i>Juncus balticus</i>	Baltic rush	1, 2	10 Cu. In. Plug/ 9" o.c.	UF	☀	<p>Wetland native species.</p> <p>Do not use in hot ROW locations.</p>	C	<p>May require supplementary irrigation during prolonged dry periods.</p> <p>Will die off if sheared too frequently.</p> <p>LOS A: Can be sheared more frequently if foliage collapses.</p>

Table E.5 (continued). Sun List.

EG	DT	NWN	Height from Ground	Scientific Name	Common Name	Planting Zone	Suggested Size/ Spacing	Urban Frontage	Exposure	Design Comments	O&M Code	Additional O&M Comments
EG		NWN	24"–36"	<i>Juncus effusus</i> 'Quartz Creek'	Quartz Creek Soft Rush	1, 2	10 Cu. In. Plug/ 9" o.c.	UF	☀, ∅		C	LOS A: Can be sheared more frequently if foliage collapses.
EG	DT		<24"	<i>Juniperus conferta</i> 'Blue Pacific'	Blue Pacific Shore juniper	3, 4	1 Gal./3' o.c.	UF	☀		E	
	DT	NWN	36"	<i>Leersia oryzoides</i>	Rice Cutgrass	1, 2	10 Cu. In. Plug/ 9" o.c.		☀	Limit to areas of approx. 36"x36"	B	LOS A: For neater appearance, trim seedheads.
EG	DR	NWN	<24"	<i>Mahonia repens</i>	Creeping Oregon holly-grape	3, 4	1 Gal./18" o.c.	UF	☀, ∅		E	
	DR		36"	<i>Miscanthus sinensis</i> 'Little Kitten'	Little Kitten Maiden Grass	3	1 Gal./15" o.c.	UF	☀		B	
	DT		30"	<i>Nepetax</i> 'Walker's Low'	Catmint	3	1 Gal./18" o.c.	UF	☀, ∅		B	
EG			36"	<i>Rhododendron</i> Yak Hybrids, such as 'Ken Janeck'	Yak Hybrid	3, 4	2 Gal./30" o.c.	UF	☀, ∅	Several other Yak hybrids stay low and neat	E	LOS A: May produce more flowers if pruned and/or deadheaded after blooming
	DT		24"–36"	<i>Rudbeckia fulgida</i> 'Goldsturm'	Black-Eyed Susan	3, 4	1 Gal./18" o.c.	UF	☀	Late season color accent.	A OR B	

Table E.5 (continued). Sun List.

EG	DT	NWN	Height from Ground	Scientific Name	Common Name	Planting Zone	Suggested Size/ Spacing	Urban Frontage	Exposure	Design Comments	O&M Code	Additional O&M Comments
	DT		<24"	<i>Sedum</i> 'Autumn Joy' or 'Matrona'	Stonecrop	3, 4	1 Gal./12" o.c.	UF	☀		G	LOS A: Can be cut back by half in June to prevent flopping.
	DT	NWN	<24"	<i>Solidago canadensis</i> 'Baby Gold' or <i>Solidago hybrida</i> 'Dansolitem'	Baby Gold or Little Lemon Goldenrod	3, 4	1 Gal./18" o.c.		☀	Late season color accent.	A	
		NWN	24"–48"	<i>Spiraea betulifolia</i> or <i>Spiraea betulifolia</i> 'Tor'	Birchleaf spirea	3	1 Gal./24" o.c.	UF	☀		E	
EG	DT	NWN	<24"	<i>Sedum oreganum</i>	Stonecrop	3, 4, 5	4" Pot/12" o.c.	UF	☀	Tolerates hot dry sites.	E	
EG	DT		<24"	<i>Teucrium chamaedrys</i>	Wall germander	3, 4	1 Gal./18" o.c.	UF	☀		E	LOS A: For neater appearance trim spent flowers in spring.
EG	DT		<24"	<i>Thymus serpyllum</i> 'Elfin'	Elfin creeping thyme	3, 4, 5	4" Pot/12" o.c.	UF	☀		F	

EG = Evergreen

SEMI = Semi-evergreen

DT = Drought Tolerant

DR = Drought Resistant

NWN = Northwest Natives or Cultivars

UF = Urban Frontage (Mixed Use/Commercial) appropriate plants

☀ = Full Sun

∅ = Part Sun/Part Shade

LOS = Level of Service

Table E.6. Native List (Sun to Part Shade includes cultivars).

EG	DT	NWN	Height from Ground	Scientific Name	Common Name	Planting Zone	Suggested Size/ Spacing	Urban Frontage	Exposure	Design Comments	O&M Code	Additional O&M Comments
	DR	NWN	24"–36"	<i>Aquilegia formosa</i>	Western Columbine	3, 4	1 Gal./18" o.c.		☀, Ø		DF	
EG	DT	NWN	<24"	<i>Arctostaphylos uva-ursi</i> 'Massachusetts' or 'Pt. Reyes'	Kinnikinnick	3, 4	1 Gal./12" o.c.	UF	☀, Ø	Possible use at vertical wall or single use low accent. Requires approval by Project Manager and Maintenance prior to use.	E	
	DR	NWN	24"–36"	<i>Camus leichtlinii</i> or <i>Camus quamash</i>	Great Camus or Common Camus	3, 4	1 Gal./12" o.c.		☀, Ø	Plant for in groups for effect. Can be planted as a bulb	DF	
EG		NWN	30"	<i>Carex densa</i>	Dense sedge	1, 2	40 Cu. In. Plug/ 9" o.c.	UF	☀	-	C	
	DR	NWN	24"–48"	<i>Carex deweyana</i>	Dewey's sedge	1, 2	10 Cu. In. Plug/ 9" o.c.		☀, Ø	Grows best on side slopes. Limit to areas of approx. 36"x36"	B	Likely to need supplementary irrigation if planted in full sun.
EG	DT	NWN	24"–48"+	<i>Carex obnupta</i>	Slough sedge	1, 2	10 Cu. In. Plug/ 9" o.c.		☀, Ø	Drought tolerant wetland native. Do not intermix with other emergents. Do not plant near intersections	C	May require supplementary irrigation during prolonged dry periods. Can be sheared more frequently if overcrowding other occurs.

Table E.6 (continued). Native List (Sun to Part Shade includes cultivars).

EG	DT	NWN	Height from Ground	Scientific Name	Common Name	Planting Zone	Suggested Size/ Spacing	Urban Frontage	Exposure	Design Comments	O&M Code	Additional O&M Comments
	DT	NWN	24"–36"	<i>Carex pachystachya</i>	Chamisso sedge	1, 2	10 Cu. In. Plug/ 9" o.c.		☀, ∅	Grows best on side slopes. Limit to areas of approx. 36"x36"	B	
		NWN	24"–36"	<i>Carex stipata</i>	Beaked sedge	1, 2	10 Cu. In. Plug/ 9" o.c.	UF	☀, ∅	Limit to areas of approx. 36"x36"	B	May require supplementary irrigation during prolonged dry periods. Will die out if mowed or trimmed too regularly.
	DT	NWN	24"–30"	<i>Cornus sericea</i> 'Kelseyii'	Kelsey redstem dogwood	1, 2, 3	2 Gal./30" o.c.	UF	☀, ∅	Limit to areas of approx. 36"x36"	E	Stems fragile until established.
		NWN	24"–40"	<i>Deschampsia caespitosa</i>	Tufted Hair Grass	1, 2	10 Cu. In. Plug/ 9" o.c.		☀, ∅	Native facultative species; does well in wet and dry conditions. Limit to areas of approx. 36"x36"	B	LOS A: For neater appearance, trim seedheads.
	DT	NWN	<24"	<i>Erigeron peregrinus</i>	subalpine fleabane daisy	3, 4	1 Gal./12" o.c.	UF	☀		DF	
	DT	NWN	36"	<i>Festuca idahoensis</i>	Idaho fescue	3, 4	1 Gal./18" o.c.		☀		DF	

Table E.6 (continued). Native List (Sun to Part Shade includes cultivars).

EG	DT	NWN	Height from Ground	Scientific Name	Common Name	Planting Zone	Suggested Size/ Spacing	Urban Frontage	Exposure	Design Comments	O&M Code	Additional O&M Comments
EG	DT	NWN	<24"	<i>Gaultheria ovatifolia</i>	Oregon wintergreen	3, 4	1 Gal./24" o.c.	UF	☀, ∅	If Gaultheria shallon is substituted see additional O&M notes	E	If height is a problem, can be sheared with hedge trimmer.
EG	DT	NWN	<24"	<i>Iris douglasiana</i>	Pacific Coast Iris	3, 4	1 Gal./18" o.c.	UF	☀	Many colors available.	G	LOS A: For neater appearance, cut back dead leaves and flower stalks.
SEMI	DT	NWN	<24"	<i>Iris missouriensis</i>	Rocky Mountain Iris	1, 2	1 Gal./12" o.c.	UF	☀		G	LOS A: For neater appearance, cut back dead leaves and flower stalks.
EG	DT	NWN	<24"	<i>Juncus balticus</i>	Baltic rush	1, 2	10 Cu. In. Plug/ 9" o.c.	UF	☀	Wetland native species. Do not use in hot ROW locations.	C	May require supplementary irrigation during prolonged dry periods. Will die off if sheared too frequently. LOS A: Can be sheared more frequently if foliage collapses.

Table E.6 (continued). Native List (Sun to Part Shade includes cultivars).

EG	DT	NWN	Height from Ground	Scientific Name	Common Name	Planting Zone	Suggested Size/ Spacing	Urban Frontage	Exposure	Design Comments	O&M Code	Additional O&M Comments
EG	DT	NWN	24"–48"+	<i>Juncus effusus</i>	Common rush	1, 2	10 Cu. In. Plug/ 9" o.c.		☀, ∅	Only <i>Juncus effusus</i> var. <i>pacificus</i> is native. Other varieties of <i>Juncus effusus</i>, even cultivars, are invasive and are not recommended for use in stormwater facilities. Do not intermix with other emergents. Do not plant near intersections	C	
EG		NWN	<24"	<i>Juncus ensifolius</i>	Dagger-leaf rush	1, 2	10 Cu. In. Plug/ 9" o.c.	UF	☀, ∅	Limit to areas of approx. 36"x36"	B	Requires supplementary irrigation in summer to thrive.
EG	DT	NWN	<24"	<i>Juncus tenuis</i>	Path rush	1, 2	10 Cu. In. Plug/ 9" o.c.	UF	☀, ∅	Native facultative species; does well in wet and dry conditions.	C	
EG	DT	NWN	<24"	<i>Juniperus communis</i> 'Mondap'	Alpine carpet juniper	4	1 Gal./24" o.c.	UF	☀		E	May require supplementary irrigation in summer. May require pruning

Table E.6 (continued). Native List (Sun to Part Shade includes cultivars).

EG	DT	NWN	Height from Ground	Scientific Name	Common Name	Planting Zone	Suggested Size/ Spacing	Urban Frontage	Exposure	Design Comments	O&M Code	Additional O&M Comments
EG		NWN	36"	<i>Ledum glandulosum</i>	Pacific or trapper's tea	1, 2, 3	5 Gal./36" o.c.	UF	☀, ∅	Plant near the bottom of swale	E	
	DT	NWN	36"	<i>Leersia oryzoides</i>	Rice Cutgrass	1, 2	40 Cu. In. Plug/ 9" o.c.		☀	Limit to areas of approx. 36"x36"	B	LOS A: For neater appearance trim seedheads.
EG	DT	NWN	<24"	<i>Lewisia cotyledon</i> or cultivars	Siskiyou lewisia	3, 4	1 Gal./12" o.c.	UF	☀		E	
EG		NWN	36"	<i>Mahonia aquifolium</i> 'Orange Flame' or 'Compacta'	Compact tall Oregon grape	3	1 Gal./36" o.c.	UF	☀, ∅		E	
EG	DR	NWN	<24"	<i>Mahonia repens</i>	Creeping Oregon grape	3, 4	1 Gal./18" o.c.	UF	☀, ∅		E	
	DT	NWN	<24"	<i>Maianthemum dilatatum</i>	False Lily of the Valley	1, 2, 3, 4	4" Pot/12" o.c.	UF	∅	Note tendency to spread	E	LOS A: Remove dead foliage in fall.
		NWN	24"-36"	<i>Mimulus guttatus</i>	Yellow monkey-flower	1, 2	1 Gal./18" o.c.		☀, ∅	Provides temporary color and habitat value. Will die back in late summer or winter but will reseed. Should not be used in large areas and relied upon for water quality treatment.	DF	

Table E.6 (continued). Native List (Sun to Part Shade includes cultivars).

EG	DT	NWN	Height from Ground	Scientific Name	Common Name	Planting Zone	Suggested Size/ Spacing	Urban Frontage	Exposure	Design Comments	O&M Code	Additional O&M Comments
EG	DT	NWN	36"	<i>Pachistima myrsinites</i>	Oregon Boxwood	3	1 Gal./36" o.c.	UF	☀, ∅		E	
		NWN	<24"	<i>Potentilla fruticosa</i> 'Sunset'	Frosty potentilla	3, 4	2 Gal./30" o.c.	UF	∅		E	
	DT	NWN	<24"	<i>Potentilla glandulosa</i> or <i>Potentilla gracilis</i>	Sticky cinquefoil or slender cinquefoil	3, 4	1 Gal./18" o.c.		☀, ∅		DF	
EG		NWN	24"–36"	<i>Polystichum imbricans</i> or <i>Polystichum lonchitis</i>	Narrow-leaf sword fern or Northern holly fern	3, 4	2 Gal./30" o.c.	UF	☀, ∅	If <i>Polystichum munitum</i> is substituted limit groups to 3 and prune yearly	B	Cut back before fronds appear.
	DT	NWN	<24"	<i>Solidago canadensis</i> 'Baby Gold' or <i>Solidago hybrida</i> 'Dansolitlem'	Baby Gold or Little Lemon Goldenrod	3, 4	1 Gal./18" o.c.		☀	Late season color accent.	A	
		NWN	24"–36"	<i>Spiraea betulifolia</i> or <i>Spiraea betulifolia</i> 'Tor'	Birchleaf spirea	3	1 Gal./24" o.c.	UF	☀		E	
EG	DT	NWN	<24"	<i>Sedum divergens</i>	Stonecrop	3, 4	4" Pot/12" o.c.	UF	☀, ∅	Tolerates hot dry sites.	E	LOS A: For neater appearance deadhead.

Table E.6 (continued). Native List (Sun to Part Shade includes cultivars).

EG	DT	NWN	Height from Ground	Scientific Name	Common Name	Planting Zone	Suggested Size/ Spacing	Urban Frontage	Exposure	Design Comments	O&M Code	Additional O&M Comments
EG	DT	NWN	<24"	<i>Sedum oreganum</i>	Stonecrop	3, 4, 5	4" Pot/12" o.c.	UF	☀	Tolerates hot dry sites.	E	
EG	DT	NWN	24"–36"	<i>Xerophyllum tenax</i>	Bear grass	3	1 Gal/18" o.c.	UF	☀	Tolerates hot dry sites.	E	

EG = Evergreen

SEMI = Semi-evergreen

DT = Drought Tolerant

DR = Drought Resistant

NWN = Northwest Natives or Cultivars

UF = Urban Frontage (Mixed Use/Commercial) appropriate plants

☀ = Full Sun

☀ = Part Sun/Part Shade

LOS = Level of Service

Table E.7. Intersection and View Restriction Palette (under 24 inches in height).

EG	DT	NWN	Height from Ground	Scientific Name	Common Name	Planting Zone	Suggested Size/ Spacing	Urban Frontage	Exposure	Design Comments	O&M Code	Additional O&M Comments
			<24"	<i>Chrysanthemum</i> 'Peach Centerpiece' or 'Bienchen'	Peach Centerpiece or golden chrysanthemum	3, 4	1 Gal./15" o.c.		☀	Late season color accent.	B & G	Pull if scraggly.
	DT		<24"	<i>Coreopsis lanceolata</i> 'Sterntaler'	Tickseed	3, 4	1 Gal./15" o.c.	UF	☀		B & G	
	DT		24"–30"	<i>Cornus sericea</i> 'Kelseyii'	Kelsey redstem dogwood	1, 2, 3	1 Gal./30" o.c.	UF	☀, ∅	Plant in bottom areas for sightlines.	E	Stems fragile until established.
EG	DT		<24"	<i>Epimedium rubrum</i> or <i>sulphurescens</i>	Barrenwort	3, 4	4" Pot/12" o.c.	UF	∅	Part shade to shade only without irrigation.	B	Cut back before flower stalks appear.
EG	DT		<24"	<i>Euonymus fortunei</i> 'Interbolwi'	Blondy winter-creeper	3, 4	1 Gal./18" o.c.	UF	☀, ∅		E	
	DT		<24"	<i>Geranium</i> 'Gerwat' 'Rozanne'	Rozanne geranium	3, 4	1 Gal./24" o.c.		☀, ∅		A	LOS A: Can be sheared for neater appearance.
EG			<24"	<i>Geum flore pleno</i> 'Blazing Sunset'	Blazing Sunset Avens	3, 4	1 Gal./18" o.c.	UF	☀, ∅		DS	
EG			<24"	<i>Hebe x</i> 'Champion'	Champion Hebe	3, 4	1 Gal./18" o.c.	UF	☀, ∅		E	
SEMI	DT		<24"	<i>Helianthemum nummularium</i> 'Wisley Primrose'	Yellow Sunrose	3, 4	1 Gal./12" o.c.	UF	∅		B	

Table E.7 (continued). Intersection and View Restriction Palette (under 24 inches in height).

EG	DT	NWN	Height from Ground	Scientific Name	Common Name	Planting Zone	Suggested Size/ Spacing	Urban Frontage	Exposure	Design Comments	O&M Code	Additional O&M Comments
EG	DT		24"–36"	<i>Helictotrichon sempervirens</i>	Blue oat grass	3	1 Gal./18" o.c.	UF	∅	36" height only when in flower. Airy flowers. Groups of 3 maximum.	C	
EG	DT		<24"	<i>Ilex</i> x 'Mondo'	Little Rascal Holly	3, 4	1 Gal./18" o.c.	UF	☀, ∅		E	
EG		NWN	<24"	<i>Juncus effusus</i> 'Carmen's Japan'	Carmen's Japanese Rush	1, 2	10 Cu. In. Plug/ 9" o.c.	UF	☀, ∅		C	
EG			<24"	<i>Juncus effusus</i> 'Spiralis'	Corkscrew soft rush	1, 2	10 Cu. In. Plug/ 9" o.c.	UF	☀, ∅		C	LOS A: Can be sheared more frequently if foliage collapses.
EG			24"–30"	<i>Juncus patens</i> or <i>Juncus patens</i> 'Elk blue'	California gray rush	1, 2	10 Cu. In. Plug/ 9" o.c.	UF	☀, ∅	Resilient wetland species: can survive summer drought and winter inundation. Plant in bottom areas for sightlines	C	LOS A: Can be sheared more frequently if foliage collapses.
EG			<24"	<i>Liriope muscari</i> and cultivars	Lily Turf	3, 4	4" Pot/12" o.c.	UF	☀, ∅		C	OK to pull clumps for ease of weed control.
EG	DR	NWN	<24"	<i>Mahonia repens</i>	Creeping Oregon holly-grape	3	1 Gal./18" o.c.	UF	☀, ∅		E	

Table E.7 (continued). Intersection and View Restriction Palette (under 24 inches in height).

EG	DT	NWN	Height from Ground	Scientific Name	Common Name	Planting Zone	Suggested Size/ Spacing	Urban Frontage	Exposure	Design Comments	O&M Code	Additional O&M Comments
	DT		<24"	<i>Narcissus</i> 'Dutch Master' or 'King Alfred'	Daffodil	3, 4	Bulb/As Shown	UF	∅		DS	Cut back foliage in summer.
		NWN	<24"	<i>Potentilla fruticosa</i> 'Sunset'	Frosty potentilla	3, 4	2 Gal./30" o.c.	UF	∅		E	
EG	DT		<24"	<i>Veronica liwanensis</i>	Speedwell	3, 4, 5	4" Pot/12" o.c.	UF	∅		E	LOS A: Cut back for neater appearance.

SEMI = Semi-evergreen

DT = Drought Tolerant

DR = Drought Resistant

NWN = Northwest Natives or Cultivars

UF = Urban Frontage (Mixed Use/Commercial) appropriate plants

☀ = Full Sun

∅ = Part Sun/Part Shade

LOS = Level of Service

Table E.8. Vertical Shrubs and Accent Plants.

EG	DT	NWN	Height from Ground	Scientific Name	Common Name	Planting Zone	Suggested Size/ Spacing	Urban Frontage	Exposure	Design Comments	O&M Code	Additional O&M Comments
		NWN	25'	<i>Amelanchier alnifolia</i>	Service Berry	1, 2, 3	Multi-stem, B&B, 5'-6' ht.		∅	Multi-stemmed are common native species. Can sucker and spread. Single stem species may be available if nursery prunes in advance.	E	May need windowing/ thinning.
			5'	<i>Cornus sanguinea</i> 'Midwinter Fire'	Midwinter Fire Dogwood	1, 2, 3	5 gal		☀, ∅		E	Prune 2/3 of all (older) branches to 8" above ground in March to keep in bounds and to maintain yellow twigs.
		NWN	6' to 8'	<i>Cornus sericea</i> 'Flaviramea'	Yellow-Twig Dogwood	1, 2, 3	5 gal		∅		E	Prune 2/3 of all (older) branches to 8" above ground in March to keep in bounds and to maintain red twigs.
			10'	<i>Hamamelis x intermedia</i> 'Pallida'	Witch Hazel	3	10 gal		☀, ∅	Vase-shaped open growing form	E	
			5'	<i>Hydrangea quercifolia</i> 'Pee Wee'	Oak-Leaf Hydrangea	3	5 gal		∅	Late summer flowers. Fall color. Bold leaves in winter.	E	May need windowing/ thinning.

Table E.8 (continued). Vertical Shrubs and Accent Plants.

EG	DT	NWN	Height from Ground	Scientific Name	Common Name	Planting Zone	Suggested Size/ Spacing	Urban Frontage	Exposure	Design Comments	O&M Code	Additional O&M Comments
EG			3'-4'	<i>Ilex glabra</i> 'Shamrock'	Inkberry	1, 2	5 gal.		☀, ∅		E	Female plants need a male pollinator to produce berries.
			3'-12'	<i>Ilex verticillata</i> and cultivated varieties	Winterberry	1, 2	5 gal.		☀, ∅		E	Female plants need a male pollinator to produce berries.
EG			8'-12'	<i>Mahonia</i> 'Arthur Menzies'	Ornamental Mahonia	3	5 gal		☀, ∅	Upright multi-stemmed.	E	
EG		NWN	6'-10'	<i>Mahonia aquifolium</i>	Oregon grape	3	5 gal		☀, ∅	Upright multi-stemmed.	E	
EG			5'	<i>Osmanthus</i> 'Goshiki'	Variegated Osmanthus	3	5 gal		∅	4' wide. Considered dwarf. New foliage is colorful.	E	May need windowing/ thinning.
			6'	<i>Physocarpus opulifolius</i> 'Nanus'	Dwarf Ninebark	1, 2, 3	5 gal		☀, ∅	Even dwarf form may be tall and wide.	E	May need windowing/ thinning.
EG			4'	<i>Pieris japonica</i> 'Little Heath'	Little Heath Lily of the Valley	3	3 gal.		∅	Variegated foliage that emerges pink in spring. Flowers in winter	E	May need windowing/ thinning.
		NWN	8'	<i>Ribes sanguineum</i> and cultivated varieties	Red Flowering Currant	3	5 gal		∅	Attracts hummingbirds	E	May need windowing/ thinning.

Table E.8 (continued). Vertical Shrubs and Accent Plants.

EG	DT	NWN	Height from Ground	Scientific Name	Common Name	Planting Zone	Suggested Size/ Spacing	Urban Frontage	Exposure	Design Comments	O&M Code	Additional O&M Comments
			15'–20'	<i>Salix integra</i> 'Hakuro Nishiki'	Dappled Willow	1, 2, 3	5 gal.		☀, Ø		E	Specify tree form; Prune to ground every other year to keep smaller
			8'–15'	<i>Sambucus nigra</i> 'Gerda'	Black Beauty Black Elder	1, 2, 3	5 gal.		☀, Ø		E	
		NWN	6'	<i>Symphoricarpos albus</i>	Snowberry	1, 2, 3	5 gal		☀, Ø	Forms thickets.	E	May need windowing/ thinning.
			6'	<i>Taxodium distichum</i> 'Peve Minaret'	Dwarf bald cypress	1, 2, 3					E	
EG		NWN	6'	<i>Vaccinium ovatum</i>	Evergreen Huckleberry	1, 2, 3	5 gal		☀, Ø		E	
			6'	<i>Vaccinium</i> 'Sunshine Blue'	Blueberry	3	5 gal		☀, Ø	Self-pollinating edible fruits. Good fall color.	E	
EG			10'	<i>Viburnum cinnamomifolium</i>	Cinnamon Viburnum	3	10 gal		☀, Ø		E	May need windowing/ thinning.
		NWN	7'–12'	<i>Viburnum edule</i>	Highbush cranberry	1, 2, 3	5 gal.		☀, Ø		E	

SEMI = Semi-evergreen

DT = Drought Tolerant

DR = Drought Resistant

NWN = Northwest Natives or Cultivars

UF = Urban Frontage (Mixed Use/Commercial) appropriate plants

☀ = Full Sun

Ø = Part Sun/Part Shade

LOS = Level of Service

Table E.9. Groundcovers if Low Profile is Required.

EG	DT	NWN	Height from Ground	Scientific Name	Common Name	Planting Zone	Suggested Size/ Spacing	Urban Frontage	Exposure	Design Comments	O&M Code	Additional O&M Comments
EG	DT		<24"	<i>Ajuga reptans</i>	Bugleweed	3, 4	4" Pot/12" o.c.	UF	☀, ∅		E	Can be pulled if grows beyond desired boundaries.
EG	DT		<24"	<i>Epimedium rubrum</i> or <i>sulphurescens</i> or cultivars	Barrenwort	3, 4	4" Pot/12" o.c.	UF	∅		B	Cut back foliage before flower stalks appear.
EG	DT		<24"	<i>Euonymus fortunei</i> 'Kewensis'	Winter-creeper euonymous	3, 4	1 Gal./18" o.c.	UF	☀, ∅		E	Can be mowed to keep low.
SEMI	DT		<24"	<i>Geranium macrorrhizum</i> 'Album' or other cultivars	Hardy Geranium	3, 4	1 Gal./18" o.c.	UF	☀, ∅		B	
	DT	NWN	<24"	<i>Maianthemum dilatatum</i>	False Lily of the Valley	1, 2, 3, 4	4" Pot/12" o.c.	UF	∅	Note tendency to spread	E	LOS-A: Remove dead foliage in fall.
EG	DT		<24"	<i>Pachysandra terminalis</i>	Japanese Spurge	3, 4	4" Pot/12" o.c.	UF	∅		C	
EG	DT		<24"	<i>Sibbaldiopsis tridentata</i> (= <i>Potentilla tridentata</i>)	Three-toothed Cinquefoil	3, 4	4" Pot/12" o.c.	UF	∅		E	

Table E.9 (continued). Groundcovers if Low Profile is Required.

EG	DT	NWN	Height from Ground	Scientific Name	Common Name	Planting Zone	Suggested Size/ Spacing	Urban Frontage	Exposure	Design Comments	O&M Code	Additional O&M Comments
EG	DT		<24"	<i>Rubus tricolor</i>	Creeping Chinese Bramble	3, 4	4" Pot/12" o.c.	UF	∅	Tolerates deep shade. Not as aggressive or spiny as other Rubus groundcovers. Red fuzzy stems and shiny leaves.	E	
EG	DT	NWN	<24"	<i>Sedum divergens</i>	Stonecrop	3, 4	4" Pot/12" o.c.	UF	☀, ∅	Tolerates hot dry sites.	E	LOS A: For neater appearance deadhead.
EG	DT		<24"	<i>Sedum requienii</i>	Miniature Stonecrop	3, 4, 5	4" Pot/12" o.c.	UF	☀, ∅	Tolerates hot dry sites.	E	
	DT	NWN	<24"	<i>Vancouveria hexandra</i>	Inside Out Flower	3, 4	4" Pot/12" o.c.	UF	∅		E	
SEMI			<24"	<i>Potentilla neumanniana</i> 'Nana'	Dwarf cinquefoil	3, 4, 5	4" Pot/12" o.c.	UF	☀, ∅		E	
EG			<24"	<i>Ophiopogon japonicus</i> 'Nanus'	Dwarf mondo grass	3, 4, 5	4" Pot/12" o.c.	UF	☀, ∅	Can space at 15" o.c. for cost saving	E	

SEMI = Semi-evergreen

DT = Drought Tolerant

DR = Drought Resistant

NWN = Northwest Natives or Cultivars

UF = Urban Frontage (Mixed Use/Commercial) appropriate plants

☀ = Full Sun

∅ = Part Sun/Part Shade

LOS = Level of Service

Table E.10. Steppable Plants.

EG	DT	NWN	Height from Ground	Scientific Name	Common Name	Planting Zone	Suggested Size/ Spacing	Urban Frontage	Exposure	Design Comments	O&M Code	Additional O&M Comments
EG			<24"	<i>Ophiopogon japonicus</i> 'Nanus'	Dwarf mondo grass	3, 4, 5	4" Pot/12" o.c.	UF	☀, ∅	Can space at 15" o.c. for cost saving	E	
SEMI			<24"	<i>Potentilla neumanniana</i> 'Nana'	Dwarf cinquefoil	3, 4, 5	4" Pot/12" o.c.	UF	☀, ∅		E	
EG	DT	NWN	<24"	<i>Sedum oreganum</i>	Stonecrop	3, 4, 5	4" Pot/12" o.c.	UF	☀	Tolerates hot dry sites.	E	
EG	DT		<24"	<i>Sedum requienii</i>	Miniature Stonecrop	3, 4, 5	4" Pot/12" o.c.	UF	☀, ∅	Tolerates hot dry sites.	E	
EG	DT		<24"	<i>Thymus serpyllum</i> 'Elfin'	Elfin creeping thyme	3, 4, 5	4" Pot/12" o.c.	UF	☀		F	
EG	DT		<24"	<i>Veronica liwanensis</i>	Speedwell	3, 4, 5	4" Pot/12" o.c.	UF	∅		E	LOS A: Cut back for neater appearance.

SEMI = Semi-evergreen

DT = Drought Tolerant

DR = Drought Resistant

NWN = Northwest Natives or Cultivars

UF = Urban Frontage (Mixed Use/Commercial) appropriate plants

☀ = Full Sun

∅ = Part Sun/Part Shade

LOS = Level of Service

Table E.11. Conifers (deciduous and evergreen).

Scientific and Common Name	Mature Urban Height	Spread	Under Wires?	Min Strip Width	Planting Zone	Fall Color	SDOT List	Design Comments
<i>Calocedrus decurrens</i> , Incense Cedar	75	15	No	8	3			
<i>Metasequoia glyptostroboides</i> , Dawn Redwood	50	25	No	6	1, 2, 3	Yes		Fast growing deciduous conifer.
<i>Pinus contorta</i> , Shore Pine	45	30	No	5	1, 2, 3			Facultative species that grows well in sandy soils. Found in wetland and upland habitats.
<i>Taxodium distichum</i> , Bald Cypress	55	35	No	8	1, 2, 3	Yes		A deciduous conifer, broadly spreading when mature – columnar when young.
<i>Taxodium distichum</i> 'Mickelson,' Shawnee Brave Bald Cypress	55	20	No	6	1, 2, 3	Yes	x	Deciduous conifer – tolerates city conditions.
<i>Thuja plicata</i> 'Excelsa' or 'Hogan,' Western Red Cedar	40	15–20	No	8	1, 2, 3			Narrow columnar form.

Table E.12. Medium/Large Broad-leaved Evergreen Trees.

Scientific and Common Name	Mature Height	Spread	Under Wires?	Min Strip Width	Planting Zone	Fall Color	SDOT List	Design Comments
<i>Lithocarpus densiflorus</i> , Tanoak	50	20	No	6	3			
<i>Quercus Ilex</i> , Holly Oak	40	30	No	5	3	N/A	x	Underside of leaf is silvery-white. Often has a prominent umbrella form. Prune for form.
<i>Umbellularia californica</i> , Oregon Myrtlewood	60	30	No	5	1, 2, 3			Drought tolerant native in S. OR. Fruit looks like miniature limes.

Table E.13. Large Deciduous Columnar Trees.

Scientific and Common Name	Mature Height	Spread	Under Wires?	Min Strip Width	Planting Zone	Fall Color	SDOT List	Design Comments
<i>Acer nigrum</i> 'Green Column,' Green Column Black Sugar Maple	50	10	No	6	3	Yes	x	
<i>Ginkgo biloba</i> 'Princeton Sentry,' Princeton Sentry Ginkgo	40	15	No	6	3	Yes	x	Prune for form
<i>Quercus robur</i> 'fastigiata,' Skyrocket Oak	40	15	No	6	3	N/A	x	

Table E.14. Large Deciduous Trees.

Scientific and Common Name	Mature Height	Spread	Under Wires?	Min Strip Width	Planting Zone	Fall Color	SDOT List	Design Comments
<i>Acer saccharum</i> 'Commemoration' or 'Bonfire' Commemoration or Bonfire Sugar Maple	50	35	No	6	1, 2, 3	Yes	x	Resistant to leaf tatter.
<i>Fagus sylvatica</i> , Green Beech	50	40	No	6	3	Yes	x	Silvery-grey bark. Can't handle root disturbance.
<i>Fagus sylvatica</i> 'Asplenifolia,' Fernleaf Beech	60	50	No	6	3	Yes	x	Can't handle root disturbance.
<i>Ginkgo biloba</i> 'Magyar,' Magyar Ginkgo	50	25	No	6	3	Yes	x	More upright and narrow than 'Autumn Gold.' Needs training when young.
<i>Liriodendron tulipifera</i> , Tulip Tree	60+	30	No	8	1, 2, 3	Yes	x	Fast-growing tree.
<i>Platins x acerifolia</i> 'Bloodgood,' Bloodgood London Planetree	50+	40	No	8	1, 2, 3	N/A	x	More anthracnose resistant than other varieties – large tree that needs space.
<i>Quercus bicolor</i> , Swamp White Oak	60	45	No	8	1, 2, 3	N/A	x	Shaggy peeling bark. Wet-soil tolerant.
<i>Quercus coccinea</i> , Scarlet Oak	60	40	No	6	3	Yes	x	Good fall color.
<i>Quercus imbricaria</i> , Shingle Oak	60	50	No	6	3	N/A	x	Leaves can persist throughout the winter.
<i>Quercus rubra</i> , Red Oak	60	45	No	8	1, 2, 3	Yes	x	Fast growing oak – large tree that needs space. Heavy acorn producer.
<i>Tilia tomentosa</i> , Silver Linden	60	50	No	6	3	Yes		Larger leaves than Littleleaf Linden. Fragrant flowers.
<i>Ulmus</i> 'Frontier' or 'Morton Glossy,' Frontier or Triumph Elm	50	35	No	6	1, 2, 3	Yes	x	Resistant to Dutch elm disease.
<i>Zelkova serrata</i> 'Greenvase' or 'Village Green' Green Vase or Village Green Zelkova	45	40	No	6	3	Yes	x	Exfoliating bark. Dark green leaves turn orange-red and purple in fall.

Table E.15. Medium/Large Deciduous Trees.

Scientific and Common Name	Mature Height	Spread	Under Wires?	Min Strip Width	Planting Zone	Fall Color	SDOT List	Design Comments
<i>Acer campestre</i> 'Evelyn,' Queen Elizabeth Hedge Maple	40	30	No	5	1, 2, 3	Yes	x	More upright branching than the species.
<i>Acer freemanii</i> 'Autumn Blaze,' Autumn Blaze Maple	50	40	No	6	1, 2, 3	Yes	x	Cross between red and silver maple – fast growing with good fall color.
<i>Acer rubrum</i> 'Scarsen,' Scarlet Sentinel Maple	40	25	No	6	1, 2, 3	Yes	x	Leaves are darker green and larger than those of other Red Maples and hold up well in summer heat. Upright branch habit.
<i>Aesculus x carnea</i> 'Briottii,' Red Horsechestnut	30	35	No	6	3	N/A	x	Do not use near greenways or bicycle routes due to litter. Resists heat and drought better than other horse chestnuts.
<i>Betula nigra</i> , River Birch	40	30	No	5	1, 2, 3	Yes		Excellent flaky bark. Resistant to Bronze Birch Borer.
<i>Cercidiphyllum japonicum</i> , Katsura tree	45	40	No	8	1, 2, 3	Yes		
<i>Eucommia ulmoides</i> , Hardy Rubber Tree	50	40	No	6	3	N/A	x	Dark green, very shiny leaves – insignificant fall color.
<i>Fagus sylvatica</i> 'Rohanii,' Purple Oak Leaf Beech	50	30	No	6	3	N/A	x	Purple leaves with wavy margins.
<i>Ginkgo biloba</i> 'Autumn Gold,' Autumn Gold Ginkgo	45	35	No	6	3	Yes	x	Narrow when young.
<i>Nothofagus antarctica</i> , Antarctic Beech	50	35	No	5	3	No	x	Rugged twisted branching and petite foliage.
<i>Quercus frainetto</i> , Italian Oak	50	30	No	6	3	N/A	x	Drought resistant – green, glossy leaves in summer.
<i>Sophora japonica</i> 'Regent,' Japanese Pagodatree	45	40	No	6	3	Yes	x	Has a rapid growth rate and tolerates city conditions, heat, and drought.
<i>Tilia cordata</i> 'Greenspire,' Greenspire Linden	40	30	No	6	3	Yes	x	Symmetrical, pyramidal form. Fragrant flowers.
<i>Ulmus parvifolia</i> 'Emer II,' Allee Elm	45	35	No	5	1, 2, 3	Yes	x	Exfoliating bark and good fall color – Resistant to Dutch Elm Disease.

Table E.16. Medium Columnar Deciduous Trees.

Scientific and Common Name	Mature Height	Spread	Under Wires?	Min Strip Width	Planting Zone	Fall Color	SDOT List	Design Comments
<i>Acer rubrum</i> 'Bowhall,' Bowhall Maple	40	20	No	6	1, 2, 3	Yes	x	Upright, pyramidal form.
<i>Carpinus betulus</i> 'Fastigiata,' Pyramidal European Hornbeam	40	15	No	5	1, 2, 3	Yes	x	Broadens when older.
<i>Fagus sylvatica</i> 'Dawyck Purple,' Dawyck Purple Beech	40	12	No	6	3	Yes	x	Purple foliage.
<i>Oxydendron arboreum</i> , Sourwood	35	12	No	5	3	Yes	x	Consistent and brilliant fall color.
<i>Nyssa sylvatica</i> , Tupelo	40	20	No	6	1, 2, 3	Yes	x	Chunky bark. Takes standing water and drought.

Table E.17. Medium Deciduous Trees.

Scientific and Common Name	Mature Height	Spread	Under Wires?	Min Strip Width	Planting Zone	Fall Color	SDOT List	Design Comments
<i>Acer rubrum</i> 'Karpick,' Karpick Maple	40	20	No	6	1, 2, 3	Yes	x	Finer texture than other narrow forms of columnar maple.
<i>Acer truncatum</i> x <i>A. platanoides</i> 'Keithsform' or 'Warrenred,' Norwegian or Pacific Sunset Maple	35	25	No	5	3	Yes	x	Reliable reddish orange fall color.
<i>Cladrastis kentukea</i> , Yellowwood	40	40	No	5	3	Yes	x	White flowers in spring, resembling wisteria flower – blooms profusely only every 2 to 4 years – yellow/gold fall color
<i>Cornus controversa</i> 'June Snow,' Giant Dogwood	40	30	No	5	3	Yes	x	Frothy, 6-inch clusters of white flowers in June.
<i>Corylus colurna</i> , Turkish Filbert	40	25	No	5	3	Yes	x	Tight, formal, dense crown – Nice central leader. Not for mixed use areas with high pedestrian traffic dues to significant debris from nuts. Drought tolerant. Plant smaller sizes in order to facilitate establishment.
<i>Magnolia denudata</i> , Yulan Magnolia	40	40	No	5	3	N/A	x	6-inch fragrant white flowers in spring.
<i>Ostrya virginiana</i> , Ironwood	40	25	No	5	3	Yes	x	Hop like fruit – slow growing
<i>Pterostyrax hispida</i> , Fragrant Epaulette Tree	40	30	No	5	3	Yes	x	Pendulous creamy white flowers – fragrant
<i>Ulmus parvifolia</i> 'Emer I,' Athena Classic Elm	30	35	No	5	1, 2, 3	Yes	x	High resistance to Dutch Elm Disease. Drought resistant. Cinnamon colored exfoliating bark.

Table E.18. Small Conifer/Broad-leaved Evergreen Trees.

Scientific and Common Name	Mature Height	Spread	Under Wires?	Min Strip Width	Planting Zone	Fall Color	SDOT List	Design Comments
<i>Chamaecyparis obtusa gracilis</i> , Slender Hinoki False Cypress	15	6	Yes	5	3			Drought tolerant when established.
<i>Embothrium coccineum</i> , Chilean Flame Tree	30	15	No	5	3			Brilliant orange red flowers in late spring. Tree can sucker.
<i>Eucryphia glutinosa</i> , Brushbush	25	15	Yes	5	3			Semi-evergreen. Best in part shade.
<i>Magnolia grandiflora</i> 'Edith Bogue,' Edith Bogue Magnolia	18	12	Yes	5	1, 2, 3			Excellent BLE magnolia due to hardiness.
<i>Magnolia grandiflora</i> 'Victoria,' Victoria Evergreen Magnolia	25	20	Yes	5	1, 2, 3	N/A	x	
<i>Magnolia maudiae</i> (= <i>Michelia maudiae</i>), NCN	25	20	Yes	5	3			
<i>Magnolia virginiana</i>	35	35		5	1, 2, 3		x	
<i>Quercus hypoleucoides</i>	30	15	No	5	3			
<i>Quercus myrsinifolia</i> , Chinese Evergreen Oak	30	15	No	5	3			

Table E.19. Small Deciduous Trees.

Scientific and Common Name	Mature Height	Spread	Under Wires?	Min Strip Width	Planting Zone	Fall Color	SDOT List	Design Comments
<i>Acer buegerianum</i> , Trident Maple	30	30	Yes	5	3	Yes	x	Must train to a single stem – interesting bark.
<i>Acer circinatum</i> , Vine Maple	25	25	Yes	5	3	Yes	x	Avoid using on harsh sites – native tree.
<i>Acer griseum</i> , Paperbark Maple	30	20	Yes	5	3	Yes	x	Peeling cinnamon colored bark.
<i>Acer tartaricum</i> , Tartarian Maple	20	20	Yes	5	3	Yes		
<i>Acer triflorum</i> , Three-Flower Maple	25	20	Yes	5	3	Yes	x	Multi seasonal interest with tan, exfoliating bark and red, orange/red fall color.
<i>Amelanchier laevis</i> 'Snowcloud,' Snowcloud Serviceberry	25	15	Yes	4	3	Yes		
<i>Asimina triloba</i> , Paw	30	20	Yes	5	1, 2, 3	N/A	x	Burgundy flower in spring before leaves.
<i>Betula nigra</i> 'Little King,' Little King River Birch	10	12	Yes	5	1, 2, 3	Yes		Suitable for enclosed vertical walls.
<i>Carpinus caroliniana</i> , American Hornbeam	25	20	Yes	5	1, 2, 3	Yes	x	Good fall color (variable – yellow, orange, red).
<i>Cornus kousa x nuttallii</i> 'Starlight,' Starlight Dogwood	20	20	Yes	4	3	Yes		
<i>Lagerstroemia</i> 'tuscarora,' Tuscarora Hybrid Crape Myrtle	20	20	Yes	4	3	Yes	x	Light cinnamon brown bark lends year round interest – drought resistant – likes a warm site.
<i>Maackia amurensis</i> , Amur Maackia	30	20	Yes	5	3	N/A	x	Exfoliating bark – flowering in June or July – varies in intensity from year to year.
<i>Magnolia</i> 'Elizabeth,' Elizabeth Magnolia	30	20	Yes	5	3	N/A	x	Yellowish to cream colored flower in spring.

Table E.19 (continued). Small Deciduous Trees.

Scientific and Common Name	Mature Height	Spread	Under Wires?	Min Strip Width	Planting Zone	Fall Color	SDOT List	Design Comments
<i>Magnolia</i> 'Galaxy,' Galaxy Magnolia	25	25	Yes	5	1, 2, 3	Yes	x	Suitable for enclosed vertical walls. Showy pink flowers.
<i>Magnolia kobus</i> 'Wada's Memory,' Wada's Memory Magnolia'	30	20	Yes	5	3	Yes	x	Drought tolerant. Does not flower well when young.
<i>Malus</i> 'Lancelot' ('Lanzam'), Lancelot Crabapple	15	15	Yes	4	3	Yes	x	Red flower buds, blooming white – red persistent fruit.
<i>Parrotia persica</i> , Persian Parrotia	30	20	No	5	3	Yes		Blooms before it leafs out – drought tolerant – Varied fall color – reds, oranges and yellows.
<i>Frangula purshiana</i> <i>Rhamnus purshiana</i> , Cascara	30	20	Yes	5	1, 2, 3	Yes	x	Facultative native species. Found in wetland and upland habitats. Can tolerate bioretention street tree environments; however, does not grow as well in narrow, hot ROW locations. Suitable for enclosed vertical walls.
<i>Salix matsudana</i> 'Tortuosa,' Corkscrew willow	30	15	Yes	5	1, 2, 3	Yes		Do not use with underdrain.
<i>Stewartia pseudocamellia</i> , Japanese Stewartia	25	15	Yes	5	3	Yes		Camellia-like flowers in summer. Interesting bark. Slow grower.
<i>Styrax japonica</i> , Japanese Snowbell	25	25	Yes	5	3	Yes	x	Reliable and easy to grow, it has plentiful, green 1/2-inch seeds. Flowers similar to lily in the valley.
<i>Tilia cordata</i> 'Chancole' or 'De Groot,' Chancellor or De Groot Littleleaf Linden	30+	20	No	C = 6, D = 5	3	Yes	x	Pyramidal when young. Fragrant flowers that attract bees. One of the smaller stature littleleaf lindens.

Biofiltration Swales

Table E.20. Plants Tolerant of Frequent Saturated Soil Conditions or Standing Water.

EG	DT	NWN	Agg ^a	Scientific Name	Common Name	BMP Comments	
						Application	Mowable
	DT		A	<i>Agrostis</i> spp.	Bentgrass	S	M
SEMI	DT	NWN		<i>Agrostis exarata</i>	Spike bentgrass	S	M
	DT		A	<i>Agrostis alba</i> or <i>gigantea</i>	Redtop	S	M
EG	DT		A	<i>Agrostis tenuis</i> or <i>capillaris</i>	Colonial bentgrass	S	M
EG				<i>Alopecurus aequalis</i>	Shortawn foxtail	S	M
EG				<i>Alopecurus geniculatus</i>	Water foxtail	S	M
EG			A	<i>Alopecurus pratensis</i>	Meadow foxtail	S	M
EG	DT	NWN		<i>Bromus carinatus</i>	California brome	S	M
SEMI				<i>Carex densa</i>	Dense sedge		
EG		NWN		<i>Carex obnupta</i>	Slough sedge		
SEMI				<i>Carex stipata</i>	Sawbeak sedge		
SEMI				<i>Eleocharis palustris</i>	Spike rush		
EG	DT	NWN		<i>Elymus glaucus</i>	Blue wildrye	S	M
EG	DT	NWN		<i>Elymus mollis</i>	Dune wildrye	S	M
		NWN		<i>Glyceria borealis</i>	Northern mannagrass		
		NWN		<i>Glyceria elata</i>	Tall mannagrass		
				<i>Glyceria grandis</i>	American mannagrass		
EG	DT		A	<i>Juncus effusus</i>	Soft (common) rush		
SEMI	DT			<i>Juncus patens</i>	Spreading rush		
SEMI	DT			<i>Juncus tenuis</i>	Slender rush		
EG			A	<i>Poa trivialis</i>	Rough-stalked bluegrass	S	M
SEMI		NWN		<i>Scirpus acutus</i>	Hardstem bulrush		
SEMI	DT	NWN		<i>Scirpus microcarpus</i>	Small-fruited bulrush		

EG = Evergreen

SEMI = Semi-evergreen

DT = Drought Tolerant/Resistant

NWN = Northwest Natives or Cultivars

A = Aggressive

S = Allowable as seed

M = Mowable

^a Aggressive category indicates plants to be used with caution or avoided in confined sites (e.g., right-of-way plantings), near greenbelts, etc., due to maintenance concerns.

Note: Plants with mature height over 3' should be grouped in masses no wider than 12' mature width with openings of minimum 10' between masses.

Note: Designer needs to respond to the size and aspect of the individual [facility-BMP](#) when selecting plants to be used.

Table E.21. Plants Suitable for the Upper Side Slopes of a Biofiltration Swale.

EG	DT	NWN	Agg ^a	Scientific Name	Common Name	BMP Comments	
						Application	Mowable
Groundcovers							
EG	DT	NWN	A	<i>Achillea millefolium</i>	Common yarrow		
	DT	NWN		<i>Arctostaphylos uva-ursi</i>	Kinnikinnick		
	DT	NWN		<i>Allium Cernum</i>	Nodding onion		
SEMI	DT			<i>Epimedium grandiflorum</i>	Epimedium		
EG	DT			<i>Euonymus fortunei</i>	Wintercreeper		
EG	DT	NWN	A	<i>Fragaria chiloensis</i>	Beach strawberry		
		NWN		<i>Lupinus latifolius</i>	Broadleaf lupine		
	DT			<i>Omphalodes verna</i>	Creeping forget-me-not		
EG	DT		A	<i>Rubus calycinoides</i>	Creeping raspberry		
EG	DT	NWN		<i>Sedum oreganum</i>	Oregon stonecrop		
EG	DT	NWN		<i>Sedum divergens</i>	Cascade stonecrop		
EG	DT		A	<i>Trifolium repens</i>	White lawn clover	S	M
Grasses (drought-tolerant, minimum mowing)							
EG				<i>Buchloe dactyloides</i>	Buffalo grass	S	M
EG	DT			<i>Festuca</i> spp. (e.g., Many Mustang, Silverado)	Dwarf tall fescues	S	M
EG				<i>Festuca amethystine</i>	Tufted fescue	S	
EG	DT		A	<i>Festuca arundinacea</i>	tall fescue grass	S	M
EG	DT			<i>Festuca ovina duriuscula</i> (e.g., Reliant, Aurora)	Sheep fescue		
EG	DT	NWN		<i>Festuca idahoensis</i>	Idaho fescue		
EG	DT	NWN	A	<i>Festuca rubra</i>	Creeping red fescue	S	M
EG	DT		A	<i>Festuca rubra</i> var. <i>commutata</i>	Chewings fescue	S	M
EG	DT			<i>Helictotrichon sempervirens</i>	Blue oatgrass		

EG = Evergreen

SEMI = Semi-evergreen

DT = Drought Tolerant/Resistant

NWN = Northwest Natives or Cultivars

A = Aggressive

S = Allowable as seed

M = Mowable

^a Aggressive category indicates plants to be used with caution or avoided in confined sites (e.g., right-of-way plantings), near greenbelts, etc., due to maintenance concerns.

Note: Plants with mature height over 3' should be grouped in masses no wider than 12' mature width with openings of minimum 10' between tall plant masses.

Note: Designer needs to respond to the size and aspect of the individual [facility-BMP](#) when selecting plants to be used.

Table E.22. Recommended Plants for Wet Biofiltration Swales.

EG	DT	NWN	Agg ^a	Scientific Name	Common Name	BMP Comments	
						Application	Mowable
SEMI	DT	NWN		<i>Agrostis exarata</i>	Spike bentgrass	S	M
EG	DT		A	<i>Agrostis tenuis</i> or <i>capillaris</i>	Colonial bentgrass	S	M
				<i>Alopecurus aequalis</i>	Shortawn foxtail	S	M
				<i>Alopecurus geniculatus</i>	Water foxtail	S	M
				<i>Eleocharis</i> spp.	Spike rush		
SEMI				<i>Carex densa</i>	Dense sedge		
EG		NWN		<i>Carex obnupta</i>	Slough sedge		
SEMI		NWN		<i>Carex stipata</i>	Sawbeak sedge		
				<i>Carex</i> spp.	Sedge		
EG	DT		A	<i>Festuca arundinacea</i> var.	Tall fescue grass	S	M
EG	DT	NWN	A	<i>Festuca rubra</i>	Creeping red fescue	S	M
				<i>Glyceria occidentalis</i>	Western mannagrass		
EG	DT		A	<i>Juncus effusus</i>	Soft (common) rush		
SEMI	DT			<i>Juncus patens</i>	Spreading rush		
SEMI	DT	NWN		<i>Juncus tenuis</i>	Slender rush		
EG			A	<i>Lolium perenne</i> – Var. dwarf	Dwarf ryegrass	S	
SEMI		NWN		<i>Oenanthe sarmentosa</i>	Water parsley		
SEMI		NWN		<i>Scirpus acutus</i>	Hardstem bulrush		
SEMI	DT	NWN		<i>Scirpus microcarpus</i>	Small-fruited bulrush		

EG = Evergreen

SEMI = Semi-evergreen

DT = Drought Tolerant/Resistant

NWN = Northwest Natives or Cultivars

A = Aggressive

S = Allowable as seed

M = Mowable

^a Aggressive category indicates plants to be used with caution or avoided in confined sites (e.g., right-of-way plantings), near greenbelts, etc., due to maintenance concerns.

Note: Plants with mature height over 3' should be grouped in masses no wider than 12' mature width with openings of minimum 10' between tall plant masses.

Note: Designer needs to respond to the size and aspect of the individual [facility-BMP](#) when selecting plants to be used.

Sand Filters

Table E.23. Recommended Plants for Sand Filters.

EG	DT	NWN	Agg ^a	Scientific Name	Common Name	BMP Comments	
						Application	Mowable
Basin Sides							
	DT	NWN		<i>Achillea millefolium</i>	Yarrow	S	
EG	DT			<i>Agrostis alba</i>	Redtop	S	M
EG	DT	NWN		<i>Agrostis exarata</i>	Spike bentgrass	S	M
EG	DT			<i>Agrostis palustris</i>	Creeping bentgrass	S	M
	DT			<i>Alopecurus pratensis</i>	Meadow foxtail	S	M
EG	DT	NWN		<i>Bromus carinatus</i>	California Brome	S	M
	DT	NWN		<i>Calamagrostis nutkaensis</i>	Pacific reed grass		
EG	DT	NWN		<i>Elymus glaucus</i>	Blue wildrye	S	M
EG	DT	NWN		<i>Elymus mollis</i>	Dune wildrye	S	M
EG	DT	NWN	A	<i>Juncus effusus</i>	Soft rush	S	
	DT	NWN		<i>Lupinus albicaulus</i>	Sickle keeled lupine	S	
EG	DT	NWN		<i>Luzula multiflora</i>	Field woodrush	S	
	DT		A	<i>Poa palustris</i>	Fowl bluegrass	S	M
EG			A	<i>Poa pratensis</i>	Kentucky bluegrass	S	M
Pond Bottom (Sand Surface)							
EG	DT			<i>Agrostis tenuis</i>	Colonial bentgrass (Highland strain good)	S	M
	DT			<i>Buchloe dactyloides</i>	Buffalo grass	S	M
	DT	NWN		<i>Camassia leichlinii</i> or <i>quamash</i>	camas		
EG	DT	NWN		<i>Carex mertensii</i>	Merten's sedge	S	
EG	DT	NWN		<i>Festuca elatior</i> (arundinacea)	Tall fescue	S	M
EG	DT	NWN		<i>Festuca elatior</i> "Many Mustang," "Silverado"	Dwarf tall fescues	S	M
EG	DT	NWN		<i>Fescue roemeri</i> (idahoensis)	Roemer's or Idaho fescue	S	
EG	DT	NWN		<i>Festuca rubra</i>	Red fescue	S	M
SEMI	DT	NWN		<i>Iris missouriensis</i>	Rocky Mountain iris		
EG	DT	NWN		<i>Juncus tenuis</i>	Slender rush	S	
EG	DT			<i>Lolium perenne</i>	Perennial ryegrass	S	M
EG	DT	NWN		<i>Luzula parviflora</i>	Small flowered woodrush	S	
EG	DT			<i>Trifolium repens</i>	White lawn clover	S	M
EG	DT			<i>Zoysia tenuifolia</i>	Korean grass	S	M

EG = Evergreen

A = Aggressive

SEMI = Semi-evergreen

S = Allowable as seed

DT = Drought Tolerant/Resistant

M = Mowable

NWN = Northwest Natives or Cultivars

^a Aggressive category indicates plants to be used with caution or avoided in confined sites (e.g., right-of-way plantings), near greenbelts, etc., due to maintenance concerns.

Note: Plants with mature height over 3' should be grouped in masses no wider than 8' mature size with openings of min. 10' between tall plant masses.

Note: Designer needs to respond to the size and aspect of the individual [facility-BMP](#) when selecting plants to be used.

Wet Ponds

Table E.24. Plants for Wet Pond Peripheries.

EG	DT	NWN	Agg ^a	Scientific Name	Common Name	BMP Comments	
						Application ^b	Mature Height
Trees to Provide Shading^c							
	DT	NWN		<i>Acer circinatum</i>	Vine maple	W	25'
				<i>Betula nigra</i>	River birch	W	40'
EG		NWN		<i>Myrica californica</i>	Pacific wax myrtle		18'
				<i>Nyssa Sylvatica</i>	Tupelo	W	40'
		NWN		<i>Oemleria cerasiformis</i>	Indian plum		10'
		NWN		<i>Prunus emarginata</i>	Wild cherry		40'
				<i>Taxus brevifolia</i>	Pacific yew		40'
EG	DT	NWN		<i>Thuja plicata</i>	Western red cedar	W	40'
Small Trees/High Shrubs with Fibrous Roots for Berms							
		NWN		<i>Acer circinatum</i>	Vine maple	W	25'
		NWN		<i>Amelanchier alnifolia</i>	Serviceberry		25'
EG	DT			<i>Arbutus unedo</i>	Strawberry tree		25'
		NWN		<i>Comus Stolonifera</i>	Red twig dogwood	W	20'
		NWN		<i>Corylus comuta var. cornuta</i>	Filbert		20'
		NWN		<i>Physocarpus capitatus</i>	Pacific ninebark		12'
		NWN	A	<i>Rubus spectabilis</i>	Salmonberry	W	8'
		NWN		<i>Sambucus racemosa</i>	Red elderberry		10'
				<i>Vaccinium opulus</i>	Highbush cranberry		10'
				<i>Vaccinium spp.</i>	Blueberry		4'-12'
Low Shrubs and Grasses with Fibrous Roots for Berms							
EG		NWN		<i>Arctostaphylos uva-ursi</i>	Kinnikinnick		0.5'
				<i>Cistus spp.</i>	Rock rose		2'-4'
SEMI		NWN		<i>Deschampsia cespitosa</i>	Tufted hairgrass		3'
EG	DT			<i>Festuca arundinacea</i>	tall fescue grass		3'
EG	DT			<i>Festuca ovina duriuscula</i> (e.g., Reliant, Aurora)	Sheep fescue		1'
		NWN		<i>Festuca rubra</i>	red fescue	W	0.5'
EG		NWN		<i>Gaultheria shallon</i>	Salal		4'
				<i>Helictotrichon sempervirens</i>	blue oatgrass		3'
EG		NWN		<i>Ledum groenlandicum</i>	Labrador tea	W	5'
				<i>Polystichum munitum</i>	sword fern	W	4'
		NWN	A	<i>Symphoricarpus albus</i>	Snowberry		5'
			(A)	e.g., <i>Miscanthis</i> , <i>Pennisetum</i>	Ornamental grasses		varies

EG = Evergreen

NWN = Northwest Natives or Cultivars

SEMI = Semi-evergreen

A = Aggressive

DT = Drought Tolerant/Resistant

W = Wet Tolerant

^a Aggressive category indicates plants to be used with caution or avoided in confined sites (e.g., right-of-way plantings), near greenbelts, etc., due to maintenance concerns.

^b Tolerant of occasional saturated soils or minimal inundation (<6" depth) for short periods (<72 hours).

^c If BMP has a liner, designer should review plants accordingly; trees generally are not appropriate to liner conditions.

Note: Plants with mature height over 3' should be grouped in masses no wider than 8' mature size with openings of min. 10' between tall plant masses.

Note: Designer needs to respond to the size and aspect of the individual [facility-BMP](#) when selecting plants to be used.

Note: Many factors contribute to waterfowl use of ponds and adjacent areas. Designers should investigate site-specific conditions and best practice methods to discourage waterfowl use as necessary.

E-10. Drywell Sizing Tables

The City has determined that the most common small project overflow scenario consists of a drywell situated downstream of a bioretention cell or a permeable pavement facility. For small projects with no approved off-site point of discharge (refer to *Volume 3, Section 4.3.2*), Table E.25, Table E.26, and Table E.27E.26 specify the required area for drywells of 4-foot and 6-foot depths to be used as overflow/point of discharge downstream of a bioretention cell or a permeable pavement facility sized for the water quality treatment standard, pre-developed pasture standard, and the on-site stormwater management standard for parcel-based and single-family residential projects, respectively.

The minimum measured infiltration rate from a Small or Large Pilot Infiltration Test (PIT) that is required to use these tables is 0.25 inches per hour (in/hr).

Table E.25. ~~Parcel-Based Projects:~~ Drywell Sizing Downstream of Bioretention Sized for Water Quality Treatment Standard ~~Sized for 91% Infiltration~~ or Permeable Pavement Facility.^c

Contributing Area (sf)	Drywell Area (sf) ^{a, b, c}	
	Drywell Depth = 4 ft	Drywell Depth = 6 ft
500	27	19
1,000	98	67
1,500	164	115
2,000	240	169
2,500	314	222
3,000	390	278
3,500	468	336
4,000	548	396
4,500	630	459
5,000	713	524

^a Sizing was performed using a 5-minute computational time-step and the "Seattle 38" 158-year synthetic precipitation series.

^b Drywell was sized to minimize the 25-year peak flow target to no more than 0.0001 cfs. Drywell design/modeling representation included a 4-foot or 6-foot depth, 25 percent porosity, 0.25 in/hr measured soil infiltration rate, and a variable length and width.

^c Bioretention and permeable pavement facilities must be sized per the pre-sized requirements in Volume 3 based on the amount of contributing area design/modeling representation included 6 inches of ponding, 0.25 in/hr measured soil infiltration rate, 3H:1V BMP side slopes, 12-inch bioretention soil thickness, 40 percent porosity, 3 in/hr bioretention soil infiltration rate, and a 12-inch overflow structure diameter.

Table E.26. ~~Single-Family Residential Projects: Drywell Sizing Downstream of Bioretention Sized for the Pre-Developed Pasture Standard Sized for 95% Infiltration or Permeable Pavement Facility.~~^c

Contributing Area (sf)	Drywell Area (sf) ^{a, b, c}	
	Drywell Depth = 4 ft	Drywell Depth = 6 ft
500	14	9
1,000	71	49
1,500	130	90
2,000	200	137
2,500	260	184
3,000	326	234
3,500	393	286
4,000	462	341
4,500	532	399
5,000	605	458

^a Sizing was performed using a 5-minute computational time-step and the "Seattle 38" 158-year synthetic precipitation series.

^b Drywell was sized to minimize the 25-year peak flow target to no more than 0.0001 cfs. Drywell design/modeling representation included a 4-foot or 6-foot depth, 25 percent porosity, 0.25 in/hr measured soil infiltration rate, and a variable length and width.

^c Bioretention ~~and permeable pavement facilities must be sized per the pre-sized requirements in Volume 3 based on the amount of contributing design/modeling representation included 6 inches of ponding, 0.25 in/hr measured soil infiltration rate, 3H:1V BMP side slopes, 12-inch bioretention soil thickness, 40 percent porosity, 3 in/hr bioretention soil infiltration rate, and a 12-inch overflow structure diameter.~~

Table E.27. ~~Drywell Sizing Downstream of Bioretention Sized for the On-Site Stormwater Management Standard.~~

Contributing Area (sf)	Bioretention Bottom Area (sf) ^{a, b}	Drywell Area (sf) ^{b, c}	
		Drywell Depth = 4 ft	Drywell Depth = 6 ft
<u>500</u>	<u>9</u>	<u>56</u>	<u>39</u>
<u>1,000</u>	<u>17</u>	<u>99</u>	<u>68</u>
<u>1,500</u>	<u>30</u>	<u>170</u>	<u>119</u>
<u>2,000</u>	<u>44</u>	<u>249</u>	<u>178</u>
<u>2,500</u>	<u>60</u>	<u>332</u>	<u>238</u>
<u>3,000</u>	<u>76</u>	<u>417</u>	<u>299</u>
<u>3,500</u>	<u>94</u>	<u>501</u>	<u>361</u>
<u>4,000</u>	<u>112</u>	<u>587</u>	<u>424</u>
<u>4,500</u>	<u>131</u>	<u>665</u>	<u>488</u>
<u>5,000</u>	<u>151</u>	<u>753</u>	<u>544</u>

^a ~~Bioretention design/modeling representation included 6 inches of ponding, 0.25 in/hr measured soil infiltration rate, 3H:1V BMP side slopes, a square bottom area, 12-inch bioretention soil thickness, 40 percent porosity, 3 in/hr bioretention soil infiltration rate, and a 12-inch overflow structure diameter.~~

^b ~~Sizing was performed using a 5-minute computational time-step and the "Seattle 38" 158-year synthetic precipitation series.~~

^c ~~Drywell was sized to reduce the 25-year peak discharge rate to no more than 0.0001 cfs. Drywell design/modeling representation included a 4-foot or 6-foot depth, 25 percent porosity, 0.25 in/hr measured soil infiltration rate, and a square bottom area.~~

~~Drywells that do not meet the above design criteria and the assumptions shall be sized to meet the Peak Control Standard per Volume 3, Section 5.4.3. For projects that discharge directly to a drywell (if a bioretention cell or permeable pavement facility are not feasible~~

upstream), the drywell shall be sized to meet the Peak Control Standard per Volume 3, Section 5.4.3. Table E.27-28 specifies the required area for drywells of 4-foot and 6-foot depths that are not located downstream of a bioretention cell or permeable pavement facility.

Table E.27-28. Drywell Sizing Without Bioretention or Permeable Pavement Facility Upstream.

Contributing Area (sf)	Drywell Area (sf) ^{a, b}	
	Drywell Depth = 4 ft	Drywell Depth = 6 ft
500	125	88
1,000	249	175
1,500	347	263
2,000	498	350
2,500	623	438
3,000	747	526
3,500	872	613
4,000	996	701
4,500	1,121	788
5,000	1,245	876

a Sizing was performed using a 5-minute computational time-step and the “Seattle 38” 158-year synthetic precipitation series.

b Drywell was sized to minimize the 25-year peak flow target to no more than 0.0001 cfs. Drywell design/modeling representation included a 4-foot or 6-foot depth, 25 percent porosity, 0.25 in/hr measured soil infiltration rate, and a variable length and width.

Drywells that do not meet the above design criteria and assumptions shall be sized to meet the requirements for projects with no offsite point of discharge per Volume 3, Section 4.3.2.

APPENDIX F

Hydrologic Analysis and Design

This Cover to be Replaced in PDF
with SPU-Provided Cover

Note:

Some pages in this document have been purposely skipped or blank pages inserted so that this document will copy correctly when duplexed.

Table of Contents

F-1. Introduction	1
F-2. Applicability of Hydrologic Analysis Methods	1
F-3. General Modeling Guidance.....	2
Historical Precipitation Data	3
Watershed Characterization	3
Calculation of Total Impervious Area.....	4
Calculation of Effective Impervious Area	4
Soil and Infiltration Parameters	7
Hydrologic Soil Groups	7
Infiltration Equations	7
Outfalls	12
Outfalls to Lakes and the Ship Canal.....	12
Tidal Influence/Sea Level Rise.....	13
F-4. Continuous Rainfall-Runoff Methods	14
Precipitation Input.....	14
Land Cover Categorization	15
Soil and Infiltration Parameters	15
Soil Mapping.....	15
Infiltration Parameters.....	17
Modeling Guidance.....	17
Computational Time Step Selection.....	17
HSPF Parameter Modification	18
Steps for Hydrologic Design Using Continuous Rainfall-Runoff Models	20
Flow Control Facility Design.....	21
Water Quality Treatment BMP Design.....	40
F-5. Single-Event Rainfall-Runoff Methods.....	45
Design Storm Hyetographs.....	45
Short-Duration Storm (3-hour)	47
Intermediate-Duration Storm (18 hour)	47
24-Hour Dimensionless Design Storm.....	48
Long-Duration Storm (64 hour).....	49
Curve Number Equation and Infiltration Parameters	53
Time of Concentration Estimation	55
Single-Event Routing Methods Overview	59
Unit Hydrograph Routing Methods.....	59
SBUH Routing Method.....	60
Level-Pool Routing Method	62

Modeling Guidance..... 63
 Steps for Hydrologic Design Using Single-Event Methods 63
 Stormwater Conveyance 63
 F-6. Rational Method 64
 Peak Rainfall Intensity Duration Frequency (IDF curves) 64
 Runoff Coefficients 66
 Time of Concentration Estimation 67
 F-7. Risk-Based Hydrologic Design Concepts..... 67
 Uncertainty 68
 F-8. References..... 68

Attachments

- Attachment 1 Design Storm Dimensionless Hyetograph Ordinates
- Attachment 2 Precipitation Magnitude-Frequency Estimates for SPU Rain Gauge Locations
(up to 2012 data only)

Tables

Table F.1.	Hydrologic Analysis Method Applicability.	2
Table F.2.	City of Seattle Rain Gauge Stations.	3
Table F.3.	Hydrologic Soil Group Definition for Common Soils in King County.	7
Table F.4.	Green-Ampt Infiltration Parameters.	9
Table F.5.	Estimates of Holtan AH.	10
Table F.6.	Estimates of Holtan FC Values.	10
Table F.7.	Physical Characteristics of Seattle Lakes.	12
Table F.8.	Continuous Model Land Cover and Areas of Application.	16
Table F.9.	Relationship Between Hydrologic Soil Group and Continuous Model Soil Group.	16
Table F.10.	Pervious Land Soil Type/Cover Combinations used with HSPF Model Parameters.	17
Table F.11.	Required Runoff Parameter Values for Each Pervious Land Segment (PERLND) and Impervious Land Segment (IMPLND).	19
Table F.12.	Required Continuous Simulation Model Computational Time Step for Various Stormwater Facilities.	20
Table F.13.	Example Simulated Peak Discharge Frequency Table and Hydrographs Exported to SWMM or Other Hydraulic Model for Desired Recurrence Intervals.	45
Table F.14.	Applicability of Storm Types for Hydrologic Design Applications.	46
Table F.15.	Post-Development Runoff Curve Numbers for Selected Agricultural, Suburban, and Urban Areas.	54
Table F.16.	Values of “n” and “k” for use in Computing Time of Concentration.	57
Table F.17.	Other Values of the Roughness Coefficient “n” for Channel Flow.	58
Table F.18.	Intensity-Duration-Frequency Values for 5- to 180-Minute Durations for Selected Recurrence Intervals for the City of Seattle.	65
Table F.19.	Rational Equation Runoff Coefficients.	66
Table F.20.	Coefficients for Average Velocity Equation.	67

Figures

Figure F.1.	Active City Rain Gauge Network Stations.	5
Figure F.2.	Projected Sea Level Rise in Washington’s Waters Relative to Year 2050.	14
Figure F.3.	Example Flood-Frequency Curves for a Stormwater Pond Designed to Control Post-Developed Peak Discharge Rates to Pre-Developed Levels at the 2-Year and 10-Year Recurrence Interval.	22
Figure F.4.	Runoff from 10-Acre Forested Site.	23
Figure F.5.	Flow Duration Curve Computed Using Time Series in Figure F.4.	23
Figure F.6.	Comparison of Pre-Developed and Post-Developed Flow Duration Curves.	25
Figure F.7.	General Guidance for Adjusting Pond Performance.	26
Figure F.8.	Example of Portion of Time-Series of Daily Runoff Volume and Depiction of Water Quality Design Volume.	40
Figure F.9.	Water Quality Treatment and Detention Definition.	41
Figure F.10.	Offline Water Quality Treatment Discharge Example.	42
Figure F.11.	On-Line Water Quality Treatment Discharge Example.	43
Figure F.12.	Dimensionless Short-Duration (3-hour) Design Storm, Seattle Metropolitan Area.	47
Figure F.13.	Dimensionless Intermediate-Duration (18-hour) Design Storm, Seattle Metropolitan Area.	48
Figure F.14.	Dimensionless 24-Hour Design Storm for Seattle Metropolitan Area.	49
Figure F.15.	Dimensionless Front-Loaded Long-Duration (64-hour) Design Storm for the Seattle Metropolitan Area.	50
Figure F.16.	Dimensionless Back-Loaded Long-Duration (64-hour) Design Storm for the Seattle Metropolitan Area.	51
Figure F.17.	Characteristics of Unit Hydrographs.	59
Figure F.18.	Intensity-Duration-Frequency Curves for the City of Seattle.	65

F-1. Introduction

This appendix presents hydrologic modeling concepts to support the design of stormwater best management practices (BMPs) that meet minimum requirements in the Stormwater Code and in *Volume 1 – Project Minimum Requirements*. This appendix includes descriptions of acceptable methods for estimating the quantity and hydrologic characteristics of stormwater runoff, and the assumptions and data requirements of these methods. Specifically, hydrologic tools and methods are presented for the following tasks:

- Calculating runoff hydrographs and time series using single-event and continuous rainfall runoff models.
- Calculating peak flows for conveyance, peak flow detention and retention, and water quality rate treatment BMPs.
- Calculating volumes for detention and retention and water quality volume treatment BMPs.
- Calculating flow durations for flow duration detention and retention based requirements.

Flow control and water quality performance standards are presented in *Volume 1*. BMP design requirements and specific modeling methods are provided in *Volume 3, Chapters 4 and 5*. Any request for alternative calculation methods shall follow the principles laid out in this appendix and be approved by the Director.

F-2. Applicability of Hydrologic Analysis Methods

The choice of a hydrologic analysis method depends on the type of facility being designed (conveyance, detention, or water quality) and the required performance standard. The size of the tributary area and watershed characteristics, including backwater effects, should also be considered.

Hydrologic analysis methods may be grouped into three categories:

- **Continuous rainfall-runoff models** use multi-decade precipitation and evaporation time series as input to produce a corresponding multi-decade time series of runoff. Continuous models are used to size stormwater management facilities to meet peak or flow duration performance standards and water quality treatment requirements. Discharge rates computed with continuous models may also be used to size conveyance facilities.
- **Single-event rainfall-runoff models** simulate rainfall-runoff for a single storm, typically 2 hours to 72 hours in length, and usually of a specified exceedance probability (recurrence interval). Single-event methods are applicable for sizing conveyance facilities.
- The **rational method** is appropriate for designing conveyance systems that receive runoff from small, quickly responding areas (less than 10 acres) where short, intense storms generate the highest peak flow. This method only produces a flow peak discharge rate, and routing effects are not included. Advantages of this method are that it is easy to apply and generally produces conservative results. For larger, more complex basins, routing and timing of the flood peaks becomes more important and single-event or continuous rainfall-runoff modeling is required.

The applicability of each method is summarized in Table F.1.

Table F.1. Hydrologic Analysis Method Applicability.

Method	Applicable Models	Constraints	On-site BMP Sizing	FC BMP Sizing	WQ BMP Sizing	Conveyance Sizing	TESC Design Flow Sizing
Continuous Rainfall-runoff Modeling	<ul style="list-style-type: none"> • HSPF • MGSFlood^a • WWHM • Other^{ab} 	Refer to Table F.12 for time step requirements	✓	✓	✓	✓	✓
Single-event Rainfall-runoff Modeling	<ul style="list-style-type: none"> • NRCS (formerly SCS) TR-55 • SBUH • StormShed • Corps of Engineers HMS and HEC-1 • EPA SWMM-5, PCSWMM, and XP-SWMM • Other models approved by the Director 	Refer to Table F.14	NA	NA	NA	✓	✓
Rational Method	NA	<10 acres (measured to individual conveyance elements) Upstream of storage routing and backwater effects	NA	NA	NA	✓	✓

^a [Refer to the Approval Status of Continuous Simulation Models section of the SWMMWW for a list of currently approved models.](#)

^b The following continuous hydrologic models may also be used for project-specific situations: EPA SWMM5, ModFlow, HMS, PCSWMM, and other models approved by the Director.

BMP – Best Management Practice

FC – Flow Control

HSPF – Hydrologic Simulation Program Fortran (US EPA)

NA – Not Applicable

NRCS – Natural Resources Conservation Service

On-site – On-site Stormwater Management

SBUH – Santa Barbara Urban Hydrograph

~~SCS – Soil Conservation Service~~

SWMM – Storm Water Management Model

TESC – Temporary Erosion and Sediment Control

WQ – Water Quality

WWHM – Western Washington Hydrology Model

✓ = acceptable

F-3. General Modeling Guidance

This section includes general modeling guidance that may apply to all hydrologic analysis methods, including both continuous modeling and single-event modeling using historical precipitation data, watershed characterization, hydrologic soil groups, infiltration equations, and outfalls.

Historical Precipitation Data

Data collected from the Seattle Public Utilities (SPU) rain gauge network may be used in rainfall runoff models to aid in the design process by replicating past floods, to investigate anecdotal flood information, or for use in model calibration. Use of the historical time series is recommended, but is not required for the design of stormwater BMPs.

Continuous historical precipitation data are available from 17 active and 2 closed rain gauges from January 1978 through the present at a time step of 1 minute. Active and closed gauge names and locations are summarized in Table F.2 and active locations are summarized on Figure F.1. Continuous Rainfall-Runoff Methods (*Section F-4*) and Single-event Rainfall-runoff Methods (*Section F-5*) provide additional detail regarding selection of precipitation data.

Table F.2. City of Seattle Rain Gauge Stations.

Station ID	Station Name	Period of Record	Status
45-S001	Haller Lake Shop	1978 – current	Active
45-S002	Magnusson Park	1978 – current	Active
45-S003	UW Hydraulics Lab	1978 – current	Active
45-S004	Maple Leaf Reservoir	1978 – current	Active
45-S005	Fauntleroy Ferry Dock	1978 – current	Active
45-S007	Whitman Middle School	1978 – current	Active
45-S008	Ballard Locks	1978 – current	Active
45-S009	Woodland Park Zoo	1978 – current	Active
45-S010	Rainier View Elementary	1978 – 2008	Closed
45-S011	Metro-KC Denny Regulating	1978 – current	Active
45-S012	Catherine Blaine Elementary School	1978 – current	Active
45-S014	Lafayette Elementary School	1978 – current	Active
45-S015	Puget Sound Clean Air Monitoring Station	1978 – current	Active
45-S016	Metro-KC E Marginal Way	1978 – current	Active
45-S017	West Seattle Reservoir Treatment Shop	1978 – current	Active
45-S018	Aki Kurose Middle School	1978 – current	Active
45-S020	TT Minor Elementary	1978 – 2010	Closed
RG25	Garfield Community Center	2010 – current	Active
RG30	SPL Rainier Beach Branch	2009 – current	Active

Watershed Characterization

Prior to conducting any detailed stormwater runoff calculations, the overall relationship between the proposed project site and upstream and downstream off-site areas must be considered. The general hydrologic characteristics of the project site dictate the amount of runoff that will occur and where stormwater facilities can be placed. It is important to identify the stormwater destination point, including potential backwater effects. Drainage patterns and contributing areas can be determined from preliminary surveys of the area, available topographic contour maps, and SPU drainage system maps. Note that the drainage systems often cross topographic divides within the City of Seattle. Maps can be obtained [from](#)

through the City's GIS [web pagemap-counter](http://www.seattle.gov/util/MyServices/GIS/index.htm) (www.seattle.gov/util/MyServices/GIS/index.htm).

Calculation of Total Impervious Area

Impervious coverage for proposed development must be estimated. Impervious coverage of streets, sidewalks, hard surface trails, etc., shall be taken from plans of the site. Refer to *Volume 1, Appendix A*, and the Stormwater Code for definitions and descriptions of all surfaces that must be considered. Impervious coverage for off-site areas contributing flow to the site can be estimated from orthophotos available through GIS.

Calculation of Effective Impervious Area

Effective impervious surface is the fraction of impervious surface connected to a drainage system and is used in hydrologic simulations to estimate runoff. The effective impervious area is the total impervious area multiplied by the effective impervious fraction. Non-effective impervious surface is assumed to have the same hydrologic response as the immediately surrounding pervious area. For the existing condition modeling, areas with unconnected rooftops may be estimated from visual survey as approved by the Director.

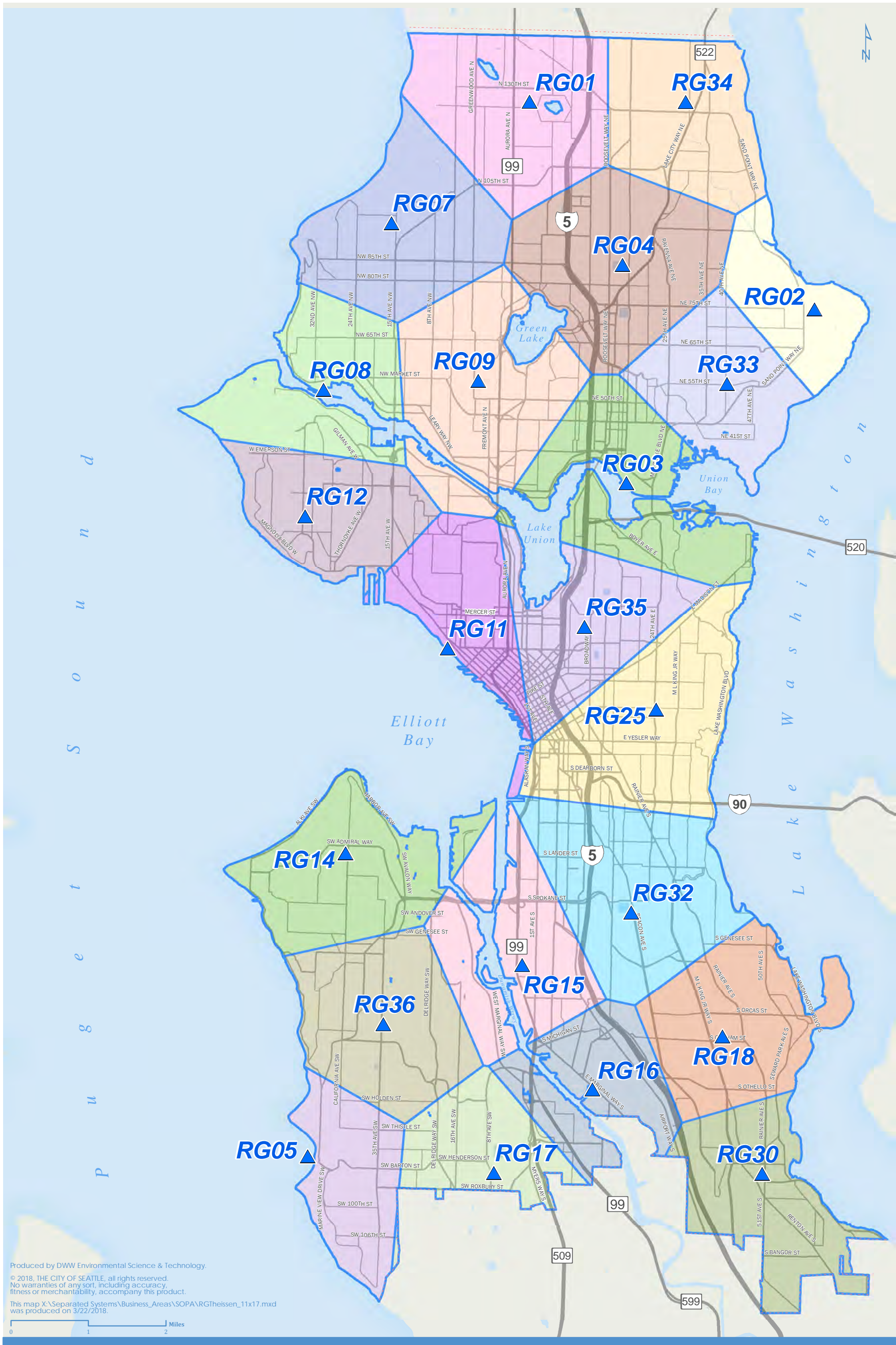

Figure F-1. Active City Rain Gauge Network Stations.

Soil and Infiltration Parameters

Hydrologic Soil Groups

Hydrologic soil groups for common soil types in the Seattle area are listed in Table F.3.

Infiltration Equations

When computing runoff in models other than those based on HSPF, an infiltration soil loss method should be used. Examples of infiltration methods include the Green-Ampt (Rawls et al. 1993), Philip (Rawls et al. 1993), and Holtan (Holtan 1961) methods. These methods are incorporated into several commonly available computer programs including StormShed, PCSWMM, HEC HMS, and HEC-1. The City recommends the use of Green-Ampt method; however, the other methods listed above can also be used based on project-specific situations.

Table F.3. Hydrologic Soil Group Definition for Common Soils in King County.

Soil Group	Hydrologic Group	Soil Group	Hydrologic Group
Alderwood	C	Orcas Peat	D
Arents, Alderwood Material	C	Oridia	D
Arents, Everett Material	B	Ovalt	C
Beausite	C	Pilchuck	C
Bellingham	D	Puget	D
Briscot	D	Puyallup	B
Buckley	D	Ragnar	B
Coastal Beaches	Variable	Renton	D
Earlmont Silt Loam	D	Riverwash	Variable
Edgewick	C	Salal	C
Everett	A	Sammamish	D
Indianola	A	Seattle	D
Kitsap	C	Shacar	D
Klaus	C	Si Silt	C
Mixed Alluvial Lan	Variable	Snohomish	D
Nellton	A	Sultan	C
Newberg	B	Tukwila	D
Nooksack	C	Urban	Variable
Normal Sandy Loam	D	Woodinville	D

Table F.3 (continued). Hydrologic Soil Group Definition for Common Soils in King County.

HYDROLOGIC SOIL GROUP CLASSIFICATIONS	
A.	Low runoff potential: Soils having high infiltration rates, even when thoroughly wetted, and consisting chiefly of deep, well-to-excessively drained sands or gravels. These soils have a high rate of water transmission
B.	Moderately low runoff potential: Soils having moderate infiltration rates when thoroughly wetted, and consisting chiefly of moderately fine to moderately coarse textures. These soils have a moderate rate of water transmission.
C.	Moderately high runoff potential: Soils having slow infiltration rates when thoroughly wetted, and consisting chiefly of soils with a layer that impedes downward movement of water, or soils with moderately fine to fine textures. These soils have a slow rate of water transmission.
D.	High runoff potential: Soils having very slow infiltration rates when thoroughly wetted and consisting chiefly of clay soils with a high swelling potential, soils with a permanent high water table, soils with a hardpan or clay later at or near the surface, and shallow soils over nearly impervious material. These soils have a very slow rate of water transmission.

Source: TR-55 (NRCS 1986), Exhibit A-1. Revisions made from [Soil Conservation Service \(SCS\)](#), Soil Interpretation Record, Form #5, September 1988.

Green-Ampt Equation

The Green-Ampt model calculates cumulative infiltration by assuming water flow into a vertical soil profile like a piston flow.

$$f_t = K \left(\frac{\psi \Delta \theta}{F_t} + 1 \right) \quad (1)$$

$$F_{t+\Delta t} = F_t + K \Delta t + \psi \Delta \theta \ln \left[\frac{F_{t+\Delta t} + \psi \Delta \theta}{F_t + \psi \Delta \theta} \right] \quad (2)$$

- Where:
- f_t = infiltration rate (mm/hr or in/hr)
 - ψ = initial matric potential of the soil (mm or inches)
 - $\Delta \theta$ = difference of soil water content after infiltration with initial water content
 - K = hydraulic conductivity (mm/hr or in/hr)
 - F_t = cumulative infiltration at time t (mm or inches)
 - $F_{t+\Delta t}$ = cumulative infiltration at time $t + \Delta t$ (mm or inches)
 - Δt = time incremental (hours)

Equation (1) is used for determining ponding situation and (2) is used for calculating the cumulative infiltration after ponding. Trial and error method is the most popular method to solve equation (2) (Chow et al. 1988). Parameters ψ , $\Delta \theta$, and K were tabulated by Chow et al. (1988) for all soil classes. Chow et al. (1988) developed a procedure to solve infiltration with changing rainfall intensity by Green-Ampt method in a table. However, since it simplifies the water movement as a piston flow, the wetting front is distorted.

Typical values suggested by Rawls, Brakensiek, and Miller (as reflected in Chow et al. 1988) are shown in Table F.4 below.

Table F.4. Green-Ampt Infiltration Parameters.

USDA Soil Classification	Suction Head ψ		Hydraulic Conductivity K		Porosity	Effective Porosity θ_e
	(mm)	(in/hr)	(mm/hr)	(in/hr)		
Sand	49.5	1.95	117.8	4.64	0.437	0.417
Loamy Sand	61.3	2.42	29.9	1.18	0.437	0.401
Sandy Loam	110.1	4.34	10.9	0.43	0.453	0.412
Loam	88.9	3.50	3.4	0.13	0.463	0.434
Silt Loam	166.8	6.57	6.5	0.26	0.501	0.486
Sandy Clay Loam	218.5	8.61	1.5	0.06	0.398	0.330
Clay Loam	208.8	8.23	1.0	0.04	0.464	0.309
Silty Clay Loam	273.0	10.76	1.0	0.04	0.471	0.432
Sandy Clay	239.0	9.42	0.6	0.02	0.430	0.321
Silty Clay	292.2	11.51	0.5	0.02	0.479	0.423
Clay	316.3	12.46	0.3	0.01	0.475	0.385

in/hr – inches per hour

mm – millimeters

mm/hr – millimeters per hour

USDA – United States Department of Agriculture

Holtan's Equation

The empirical infiltration equation devised by Holtan (1961) is explicitly dependent on soil water conditions in the form of available pore space for moisture storage:

$$F = (GI)(AH) SMD^{IEXP} + FC \quad (3)$$

- Where:
- F = surface infiltration rate at a given time (in/hr)
 - GI = Growth Index representing the relative maturity of the ground cover (0 for newly planted, 1 for mature cover)
 - AH = constant as specified below
 - SMD = soil moisture deficit at a given time (inches)
 - IEXP = infiltration exponent (default value is 1.4)
 - FC = minimum surface infiltration rate (in/hr) and occurs when SMD equals zero

Parameters GI, AH, FC, and the initial soil moisture deficit (SMD0) are the principal input parameters and can be determined as follows:

- GI is typically set to 1.0 to represent mature ground cover.
- AH can be determined from Table F.5.

- FC can be approximated from Table F.6 or by using the saturated hydraulic conductivity, which is available from soil survey reports.

Table F.5. Estimates of Holtan AH.

Land Use or Cover	Base Area Rating ^a	
	Poor Condition	Good Condition
Fallow ^b	0.10	0.30
Row crops	0.10	0.20
Small grains	0.20	0.30
Hay (legumes)	0.20	0.40
Hay (sod)	0.40	0.60
Pasture (bunchgrass)	0.20	0.40
Temporary pasture (sod)	0.40	0.60
Permanent pasture (sod)	0.80	1.00
Woods and forests	0.80	1.00

^a Adjustments needed for “weeds” and “grazing.”

^b For fallow land only, “poor condition” means “after row crop,” and “good condition” means “after sod.”

Source: Holtan et al. (1975)

Table F.6. Estimates of Holtan FC Values.

SCS-NRCS Hydrologic Soil Group	Minimum Infiltration Rates FC (inches/hour)
A	0.30–0.45
B	0.15–0.30
C	0.05–0.15
D	< 0.05

Source: Musgrave (1955)

This equation has been found to be suitable for inclusion in catchment models because of soil water dependence, and satisfactory progress has been reported for runoff predictions (Dunin 1976).

Kostiakov's Equation

Kostiakov (1932) proposed the following equation for estimating infiltration:

$$i(t) = \alpha t^{-\beta} \quad (4)$$

Where: t = time
i = infiltration rate
 α = empirical constant ($\alpha > 0$)
 β = empirical constant ($0 < \beta < 1$)

Upon integration from 0 to t , equation (4) yields equation (5), which is the expression for cumulative infiltration, $I(t)$:

$$I(t) = \frac{\alpha}{1-\beta} t^{(1-\beta)} \quad (5)$$

Where: $I(t)$ = cumulative infiltration

The constants α and β can be determined by curve-fitting equation (5) to experimental data for cumulative infiltration, $I(t)$. Since infiltration rate (i) becomes zero as $t \rightarrow \infty$, rather than approach a constant non-zero value, Kostiakov proposed that equations (4) and (5) be used only for $t < t_{\max}$ where t_{\max} is equal to $(\alpha / K_s)^{(1/\beta)}$, and K_s is the saturated hydraulic conductivity of the soil. Kostiakov's equation describes the infiltration quite well at smaller times, but becomes less accurate at larger times (Philip 1957a and 1957b; Parlange and Haverkamp 1989).

Horton's Equation

Horton (1940) proposed to estimate infiltration in the following manner,

$$i(t) = i_f + (i_0 - i_f)e^{-\gamma t} \quad (6)$$

and

$$I(t) = i_f t + \frac{1}{\gamma} (i_0 - i_f)(1 - e^{-\gamma t}) \quad (7)$$

Where: i_0 = measured infiltration rate
 i_f = final infiltration rate
 γ = empirical constant

It is readily seen that $i(t)$ is non-zero as t approaches infinity, unlike Kostiakov's equation. It does not, however, adequately represent the rapid decrease of i from very high values at small t (Philip 1957a and 1957b). It also requires an additional parameter over the Kostiakov equation. Parlange and Haverkamp (1989), in their comparison study of various empirical infiltration equations, found the performance of Horton's equation to be inferior to that of Kostiakov's equation.

Mezencev's Equation

In order to overcome the limitations of Kostiaikov's equation for large times, Mezencev (Philip 1957a and 1957b) proposed the following as modifications to equations (4) and (5). Mezencev proposed infiltration estimated by:

$$i(t) = i_f + \alpha t^{-\beta} \quad (8)$$

and

$$I(t) = i_f t + \frac{\alpha}{1-\beta} t^{(1-\beta)} \quad (9)$$

Where: i_f = final infiltration rate at steady state

Outfalls

Outfalls to Lakes and the Ship Canal

Single-event hydraulic analysis of outfalls that discharge to lakes and the Ship Canal should be performed using high water [surface elevation](#) from the observed record. This assumption may lead to conservative results and it is recommended that the designer consider using continuous simulation with a varying receiving water level. Table F.7 shows the maximum observed water levels in Seattle lakes. Water levels may vary from year to year due to sedimentation and season.

For continuous simulations, the designer may choose to use the historical record or the highest observed elevations. Lake Washington and associated waters are controlled at the Hiram M. Chittenden Locks by the US Army Corps of Engineers (USACE). Refer to the USACE Reservoir Control Center website (www.nwd-wc.usace.army.mil/nws/hh/www/index.html) for Lake Washington Ship Canal data and note that elevations given are in USACE datum and should be converted to NAVD88 before use.

Table F.7. Physical Characteristics of Seattle Lakes.

	Bitter Lake	Haller Lake	Green Lake	Lake Union	Lake Washington
Water surface elevation (feet, NAVD88) ^a	434.4	376.9	164.3	16.8	18.6
Maximum depth (feet) ^b	31.0	36.0	30.0	50.0	214.0
Mean depth (feet) ^b	16.0	16.0	13.0	34.0	108.0
Area (acres) ^b	19.0	15,044.9	259	580.0	21,500

^a SPU Engineering Support Division – Survey Field Books, measurements were all converted to NAVD88 from the old City of Seattle Vertical Datum based on a conversion factor of 9.7 feet.

^b Sources: King County ([20152014a](#)) and King County ([20162014b](#)).

Note: Water levels may vary from year to year by as much as 3 feet.

Tidal Influence/Sea Level Rise

When utilizing single-event hydraulic analysis of the drainage system or combined sewer system with outfalls that discharge to the tidally influenced Duwamish River or Puget Sound, the highest observed tide from the observed record shall be used. Match the peak rainfall intensity to a tide cycle simulation with a peak of 12.14 feet (NAVD88). This assumption may lead to conservative results and it is recommended that the designer consider using continuous simulation with a varying receiving water level.

For continuous simulations, the designer should match, by time, the historical tidal record to the historical rainfall record. For rainfall simulations where there is no observed tidal elevation, use of a tide predictor is recommended. Tidal information is available from National Oceanic and Atmospheric Administration (NOAA) (<http://tidesandcurrents.noaa.gov>) and from the US Army Corps of Engineer's (www.nws.usace.army.mil/About/Offices/Engineering/HydraulicsandHydrology/HistoricalDatumRegions.aspx). The tidal boundary is simulated as a water surface elevation time series computed using astronomical tide theory (NOAA 1995).

Sea level is rising, and for both continuous and single-event modeling, the designer should evaluate the risks depending on the project design life and objectives. ~~Since 1899, the observed trend from 1898 to 1999 was a rise of 2.062-11 mm per year, which is equivalent to 8 inches in 100 years (0.69 feet total).~~ The effect of climate change on predicted sea level rise is expected to greatly exceed that rate, but there is ~~considerable~~ uncertainty ~~regarding~~ timing and severity. The Washington Coastal Resilience Project (Miller et al. 2018) represents the best available science on sea level rise. A report by the National Research Council Committee on Sea Level Rise in California, Oregon, and Washington (NRC 2012) has provided low, medium, and high estimates of local sea level rise as shown in The report provides local projections at various likelihoods and time frames (see Figure F.2). For Seattle, the central estimate (i.e., 50 percent probability) is 1.9 to 2.3 feet of rise by 2100, and 3.0 to 3.9 feet by 2150. Upper-end estimates (1 percent probability) project 5.1 feet of rise by 2100, and 10.4 feet of rise by 2150.

~~For Puget Sound, the "medium" estimate of sea level rise is 7 inches by 2050 and 24 inches by 2100. The low probability high impact estimate is for a rise of 19 inches by 2050 and up to 56 inches by 2100.~~

For design of tidally impacted public drainage system and public combined sewer system, hydraulic analysis of sea level rise is required. For other projects, it is recommended that designers analyze risk by adjusting the tidal record upwards by 1 to 4 feet, depending on the design life and risk tolerance of the project. Likewise, designers should look to further mitigate risk by considering current design adjustments or identifying possible future modifications. For design of facilities where water level elevation at the outfall is critical, the City recommends that the designer consider storm surge due to low atmospheric pressure and/or wind and wave action.

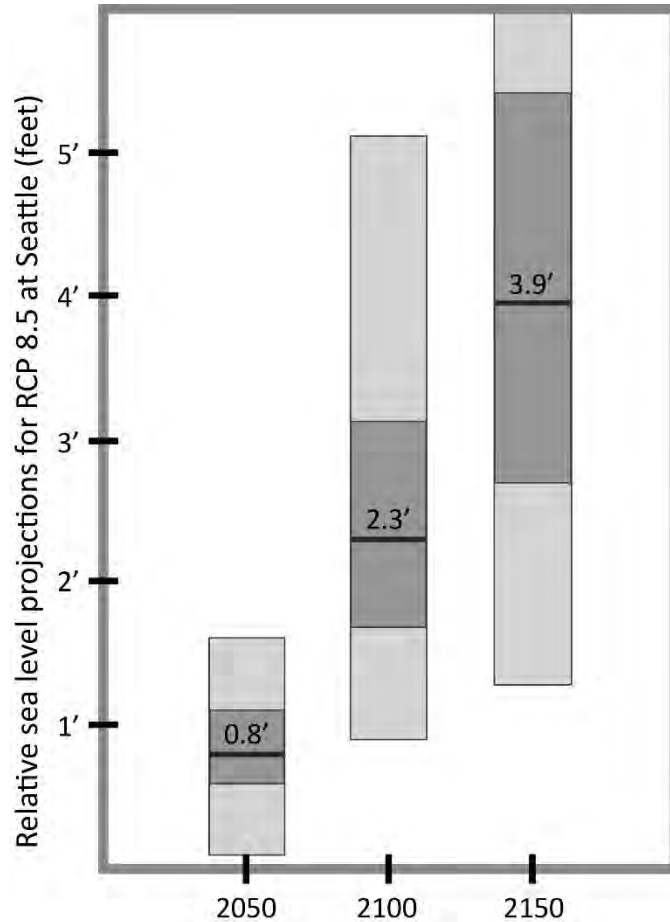

Figure F.2. Projected Sea Level Rise in Washington's Waters Relative to Year ~~2050~~2000.

F-4. Continuous Rainfall-Runoff Methods

This section includes specific modeling guidance that is applicable to continuous rainfall-runoff methods including precipitation input, land cover categorization, soil parameters, infiltration parameters, and modeling guidance.

Precipitation Input

Continuous rainfall-runoff models use multi-year inputs of precipitation and evaporation to compute a multi-year time series of runoff from the site. Using precipitation input that is representative of the site under consideration is critical for the accurate computation of runoff and the design of stormwater facilities.

Two types of precipitation and evaporation data are available for stormwater analysis. The first type is a design precipitation and evaporation time series. The design time series are appropriate for design and analysis of stormwater facilities and were developed by combining and scaling records from distant precipitation stations. The second type of time series is historical precipitation and evaporation time series (described in *Section F-3 – General*

Modeling Guidance). Because the record length of the historical precipitation and evaporation is relatively short, this data should be used for model calibration and not for design.

The City of Seattle Design Time Series consists of a precipitation and evaporation time series that are representative of the climatic conditions in the City of Seattle. The design precipitation time series was developed by combining and scaling precipitation records from widely separated stations to produce an “extended precipitation time series” with a 158-year record length (Schaefer and Barker 2002; Schaefer and Barker 2007). The precipitation scaling was performed such that the scaled precipitation record would possess the regional statistics at durations of 5 minutes, 10 minutes, 15 minutes, 20 minutes, 30 minutes, 45 minutes, 60 minutes, 2 hours, 6 hours, 24 hours, 3 days, 10 days, 30 days, 90 days, 6 months, and 12 months annual (Refer to [www.seattle.gov/sdci/codes/codes-we-enforce-\(a-z\)/stormwater-code](http://www.seattle.gov/sdci/codes/codes-we-enforce-(a-z)/stormwater-code) www.seattle.gov/dpd/codesrules/codes/stormwater/default.htm for modeling resources). The precipitation time series was developed at a 5-minute time step. For modeling of the combined sewer system, a shorter precipitation record length may be approved by the Director.

The evaporation time series waswere developed using a stochastic evaporation generating approach whereby daily evaporation was generated in a manner to preserve the daily and seasonal variability and accounting for differences observed on days with and without rainfall. The evaporation time series waswere developed from data collected at the Puyallup 2 West Experimental Station (station number 45-6803). Refer to [www.seattle.gov/sdci/codes/codes-we-enforce-\(a-z\)/stormwater-code](http://www.seattle.gov/sdci/codes/codes-we-enforce-(a-z)/stormwater-code) <http://www.seattle.gov/dpd/codesrules/codes/stormwater/default.htm> for modeling resources. The evaporation time series has a 1-hour time step.

Land Cover Categorization

~~Currently approved Ce~~continuous hydrologicflow models based on HSPF (e.g., WWHM and MGSFlood) include five land cover types: forest, pasture, lawn (or grass), wetland, and impervious. These cover types shall be applied as specified in Table F.8.

Soil and Infiltration Parameters

Soil Mapping

Mapping of soil types by the ~~Soil Conservation Service (SCS, now the National~~Natural Resources Conservation Service (NRCS), or the Washington Department of Natural Resources Geologic Information Portal (www.dnr.wa.gov/geologyportal) ~~mapping performed by the University of Washington (http://geomapnw.ess.washington.edu/)~~ may be used as a source of soil/geologic information for use in continuous hydrologic modeling. ~~The interactive online geologic maps for the Seattle area developed by the University of Washington generally provide a higher degree of resolution and better characterization of underlying soil geology.~~ If using SCS-NRCS maps, each soil type defined by the SCS-NRCS has been classified into one of four hydrologic soil groups; A, B, C, and D. Table F.3 shows ~~SCS~~hydrologic soil groups for common soil types in King County. As is common practice in hydrologic modeling in western

Washington, the soil groups used in the model generally correspond to the [SCS](#)-hydrologic soil groups as shown in Table F.9.

Table F.8. Continuous [Model Hydrologic Land Cover Groups](#) and Areas of Application.

Continuous Model Land Cover	Application	
	Pre-Developed	Post-Developed
Forest	All forest/shrub cover, irrespective of age	All permanent (e.g., protected by covenant) onsite forest/shrub cover, irrespective of age planted at densities sufficient to ensure 80%± canopy cover within 5 years.
Pasture	All grassland, pasture land, lawns, and cultivated or cleared area except for lawns in redevelopment areas with pre-development densities greater than 4 DU/GA	<ul style="list-style-type: none"> All areas that are amended using implementation options 2, 3, or 4 from Volume 3, Section 5.1.5.2 may be modeled as pasture rather than lawn (WWHM) or grass (MGSFlood). Unprotected forest in rural residential development shall be considered half pasture, half grass.
Lawn (or Grass) Landscape	Lawns in redevelopment areas with pre-development densities greater than 4 DU/GA	<ul style="list-style-type: none"> All post-development grassland and landscaping that is not amended using implementation options 2, 3, or 4 from Volume 3, Section 5.1.5.2. All onsite forested land not protected by covenant. This includes all disturbed areas required to meet the Soil Amendment BMP requirements (refer to Volume 1 and Volume 3, Section 5.1).
Wetland	All delineated wetland areas	All delineated wetland areas
Impervious	<ul style="list-style-type: none"> All impervious surfaces, including heavily compacted gravel and dirt roads, parking areas, etc. Open receiving waters (ponds and lakes) 	<ul style="list-style-type: none"> All impervious surfaces (with and without underdrains), including heavily compacted gravel and dirt roads, parking areas, etc., and Pervious surfaces with underdrains Open receiving waters (ponds, lakes, and including onsite detention ponds, and wetwater quality ponds)

[BMP – Best Management Practice](#)

DU/GA – Dwelling Unit per Gross Acre

Table F.9. Relationship Between [SCS](#)-Hydrologic Soil Group and Continuous Model Soil Group.

SCS Hydrologic Soil Group	Continuous Model Soil Group
A	Outwash
B	Till or Outwash
C	Till
D	Wetland

SCS-Type B soils can be classified as either glacial till or outwash depending on the type of soil under consideration. Type B soils underlain by glacial till or bedrock, or ~~have~~with a seasonally high water table would be classified as till. Conversely, well-drained B type soils would be classified as outwash.

~~Note that neither the University of Washington nor SCS-The NRCS~~ maps may not be used for determining infiltration capacity or ~~for a~~ design infiltration rate.

Infiltration Parameters

The following discussion on HSPF model parameters applies to the use of continuous modeling (e.g., WWHM, MGSFlood). Default model parameters that define interception, infiltration, and movement of moisture through the soil, are based on work by the United States Geological Survey (USGS) (Dinicola 1990, 2001) and King County (2009). Pervious areas have been grouped into three land cover categories (forest, pasture, and lawn) and three soil/geologic categories (till, outwash, and saturated/wetland soil) for a total of seven cover/soil type combinations as shown in Table F.10. The combinations of soil type and land cover are called pervious land segments or PERLNDs. Default runoff parameters for each PERLND are summarized in Table F.11. These parameter values are used automatically by WWHM and MGSFlood programs for each land use type. A complete description of the PERLND parameters can be found in the HSPF User Manual (US EPA 2001). For a general discussion of infiltration equations refer to *Section F-3 – General Modeling Guidance*.

Table F.10. Pervious Land Soil Type/Cover Combinations used with HSPF Model Parameters.

Pervious Land Soil Type/Cover Combinations
1. Till/Forest
2. Till/Pasture
3. Till/Lawn
4. Outwash/Forest
5. Outwash/Pasture
6. Outwash/Lawn
7. Saturated Soil/All Cover Groups

Modeling Guidance

Computational Time Step Selection

An appropriate computational time step for continuous hydrologic models depends on the type of facility under consideration and the characteristics of the tributary watershed. In general, the design of facilities dependent on peak discharge require a shorter time step than facilities dependent on runoff volume. A longer time step is generally desirable to reduce the overall simulation time provided that computational accuracy is not sacrificed. Table F.12 summarizes the allowable computational time steps for various hydrologic design applications.

HSPF Parameter Modification

In HSPF (and MGSFlood and WWHM) pervious land categories are represented by PERLNDs and impervious land categories are represented by IMPLNDs. The only PERLND and IMPLND parameter [values](#) that should be adjusted by the user are LSUR (length of surface overland flow plane in feet), SLSUR (slope of surface overland flow plane in feet/feet), and NSUR (roughness of surface overland flow plane). [The default HSPF parameter values in MGSFlood and WWHM are appropriate for large sites that are not typical for City of Seattle projects. Users are required to change the values for LSUR, SLSUR, and NSUR per guidance in Table F.11 or adjust values for LSUR, SLSUR, and NSUR based on site-specific observations. These are parameters whose values are observable at an undeveloped site, and whose values can be reasonably estimated for the proposed development site.](#) Any ~~such~~ changes [made to parameter values noted in in Table F.11 shall](#) ~~will~~ be recorded in the model output [report and included](#). ~~The user shall submit PERLND and IMPLND changes with a~~ [their](#) project submittal.

Table F.11. Required Default Runoff Parameters Values for Each Pervious Land Segment (PERLND) and Impervious Land Segment (IMPLND).

Parameter	Pervious Land Segment (PERLND)							Impervious Land Segment (IMPLND)
	Till Soil			Outwash Soil			Saturated Soil	
	Forest	Pasture	Lawn	Forest	Pasture	Lawn	Forest, Pasture, or Lawn	
LZSN	4.5	4.5	4.5	5.0	5.0	5.0	4.0	NA
INFILT	0.08	0.06	0.03	2.0	1.6	0.8	2.0	NA
<u>LSUR^a</u>	<i>2 * √Contributing Area (square feet)</i>							
<u>LSUR</u>	<u>400</u>	<u>400</u>	<u>400</u>	<u>400</u>	<u>400</u>	<u>400</u>	<u>400</u>	
<u>SLSUR^a</u>	<u>0.050-1</u>	<u>0.050-1</u>	<u>0.050-1</u>	0.05	0.05	0.05	<u>0.050-001</u>	<u>0.05</u>
KVARY	0.5	0.5	0.5	0.3	0.3	0.3	0.5	NA
AGWRC	0.996	0.996	0.996	0.996	0.996	0.996	0.996	NA
INFEXP	2.0	2.0	2.0	2.0	2.0	2.0	10.0	NA
INFILD	2.0	2.0	2.0	2.0	2.0	2.0	2.0	NA
BASETP	0.0	0.0	0.0	0.0	0.0	0.0	0.0	NA
AGWETP	0.0	0.0	0.0	0.0	0.0	0.0	0.7	NA
CEPSC	0.2	0.15	0.1	0.2	0.15	0.1	0.1	NA
UZSN	0.5	0.4	0.25	0.5	0.5	0.5	3.0	NA
<u>NSUR^a</u>	<u>0.35</u>	<u>0.3</u>	<u>0.25</u>	<u>0.35</u>	<u>0.3</u>	<u>0.25</u>	0.5	<u>0.02</u>
INTFW	6.0	6.0	6.0	0.0	0.0	0.0	1.0	NA
IRC	0.5	0.5	0.5	0.7	0.7	0.7	0.7	NA
LZETP	0.7	0.4	0.25	0.7	0.4	0.25	0.8	NA
<u>RETSC</u>	<u>NA</u>	<u>NA</u>	<u>NA</u>	<u>NA</u>	<u>NA</u>	<u>NA</u>	<u>NA</u>	<u>0.1</u>

^a LSUR, SLSUR, and NSUR parameter values shall be adjusted based on site-specific observations.

LZSN = lower zone storage nominal (inches)

INFILT = infiltration capacity (in/hr)

LSUR = length of surface overland flow plane (feet)

SLSUR = slope of surface overland flow plane (feet/feet)

KVARY = groundwater exponent variable (inch -1)

AGWRC = active groundwater recession constant (day -1)

INFEXP = infiltration exponent

INFILD = ratio of maximum to mean infiltration

BASETP = base flow evapotranspiration (fraction)

AGWETP = active groundwater evapotranspiration (fraction)

CEPSC = Interception storage (inches)

UZSN = upper zone storage nominal (inches)

NSUR = roughness of surface overland flow plane (Manning's n)

INTFW = interflow index

IRC = interflow recession constant (day⁻¹)

LZETP = lower zone evapotranspiration (fraction)

RETSC = retention storage capacity (in)

NA = not applicable

Table F.12. Required Continuous Simulation Model Computational Time Step for Various Stormwater Facilities.

Type of Analysis	Maximum Time Step
Conveyance Sizing (Off-site)	5 minutes ^a
Conveyance Sizing Upstream of Stormwater Detention Facility (Onsite), TESC Design Flows	5 minutes ^a
Conveyance Sizing Downstream of Stormwater Detention Facility (Onsite), TESC Design Flows	15 minutes
Downstream Analysis, Off-site	5 minutes ^a
Flow Control (Detention and/or Infiltration) Facility and On-site BMP Sizing	5 minutes ^a
Water Quality Design Flow Rate	15 minutes
Water Quality Design Flow Volumes/Pollutant Loading	1 hour

^a A 15-minute time step may be used if the time of concentration computed is 30 minutes or more (refer to *Time of Concentration Estimation* in Section F-5).

Steps for Hydrologic Design Using Continuous Rainfall-Runoff Models

This section presents the general process involved in conducting hydrologic analyses using continuous models. The actual design process will vary considerably depending on the project scenario, the applicable requirements, the facility being designed, and the environmental conditions.

Step #	Procedure
C-1	Review all minimum requirements that apply to the proposed project (<i>Volume 1</i>)
C-2	Review applicable site assessment requirements (<i>Volume 1, Chapter 7</i>)
C-3	Identify and delineate the overall drainage basin for each discharge point from the development site under existing conditions: <ul style="list-style-type: none"> Identify existing land use Identify existing soil types using onsite evaluation, NRCS soil survey, or mapping performed by the University of Washington (http://geomapnw.ess.washington.edu) Convert SCS-hydrologic soil types to HSPF soil classifications (till, outwash, or wetland) Identify existing drainage features such as streams, conveyance systems, detention facilities, ponding areas, depressions, etc.
C-4	Select and delineate pertinent subbasins based on existing conditions: <ul style="list-style-type: none"> Select homogeneous subbasin areas Select separate subbasin areas for onsite and off-site drainage Select separate subbasin areas for major drainage features
C-5	Determine hydrologic parameters for each subbasin under existing conditions, if required: <ul style="list-style-type: none"> Determine appropriate rainfall time series. For most design applications, the City of Seattle Design Time Series will be required. Categorize soil types and land cover Determine total and effective impervious areas within each subbasin Determine areas for each soil/cover type in each subbasin Select the required computational time step according to Table F.12
C-6	Compute runoff for the pre-developed condition. The continuous hydrologic model will utilize the selected precipitation time series, compute runoff from each subbasin, and route the runoff through the defined network. Flood-frequency and flow duration statistics will subsequently be computed at points of interest in the study area by the model.

Step #	Procedure
C-7	Determine hydrologic parameters for each subbasin under developed conditions: <ul style="list-style-type: none"> • Utilize rainfall time series selected for existing conditions • Categorize soil types and land cover • Determine total and effective impervious areas within each subbasin • Determine areas for each soil/cover type in each subbasin • Utilize computational time step selected for existing conditions
C-8	Compute runoff for the developed condition. The continuous hydrologic model will utilize the selected precipitation time series, compute runoff from each subbasin, and route the runoff through the defined network. Flood-frequency and flow duration statistics will subsequently be computed at points of interest in the study area by the model.

Additional design steps specific to flow control and water quality treatment facility design are described below.

Flow Control Facility Design

Peak Standard

Peak flow control-based standards require that the stormwater facilities be designed such that the post-development runoff peak discharge rate is controlled to one or more discharge rates, usually at specified recurrence intervals. An example of this type of standard is the Peak Flow Control Standard.

Flood-frequency analysis seeks to determine the flood flow or water surface elevation with a probability (p) of being equaled or exceeded in any given year. Return period (T_r) or recurrence interval is often used in lieu of probability to describe the frequency of exceedance of a flood of a given magnitude. Return period and annual exceedance probability are reciprocals (equation 10). Flood-frequency analysis is most commonly conducted for flood peak discharge and peak water surface elevation but can also be computed for maximum or minimum values for various durations. Flood-frequency analysis as used here refers to analysis of flood peak discharge or peak water surface elevation.

$$T_r = \frac{1}{p} \quad (10)$$

Where: T_r = average recurrence interval in years
 p = the annual exceedance probability

The annual exceedance probability of flow (or water surface elevation) may be estimated using the Gringorten (1963) plotting position formula (equation 11), which is a non-parametric approach.

$$T_r = \frac{N + 0.12}{i - 0.44} \quad (11)$$

Where: T_r = recurrence interval of the peak flow or peak elevation in years
 i = rank of the annual maxima peak flow from highest to lowest
 N = total number of years simulated

A probability distribution, such as the Generalized Extreme Value or Log-Pearson III (Interagency Advisory Committee on Water Data 1981), is not recommended for estimating the frequency characteristics.

Flood frequency analyses are used in continuous flow simulations to determine the effect of land use change and assess the effectiveness of flow control facilities. Flow control facilities are designed such that the post-developed peak discharge rate is at or below a target pre-developed peak discharge rate at one or more recurrence intervals. For example, Figure F.3 shows pre-developed and post-developed flood frequency curves for a stormwater pond designed to control peak discharges at the 2-year and 10-year recurrence intervals.

[Currently approved](#) Continuous simulation hydrologic models perform the frequency calculations and present the results in graphical and tabular form.

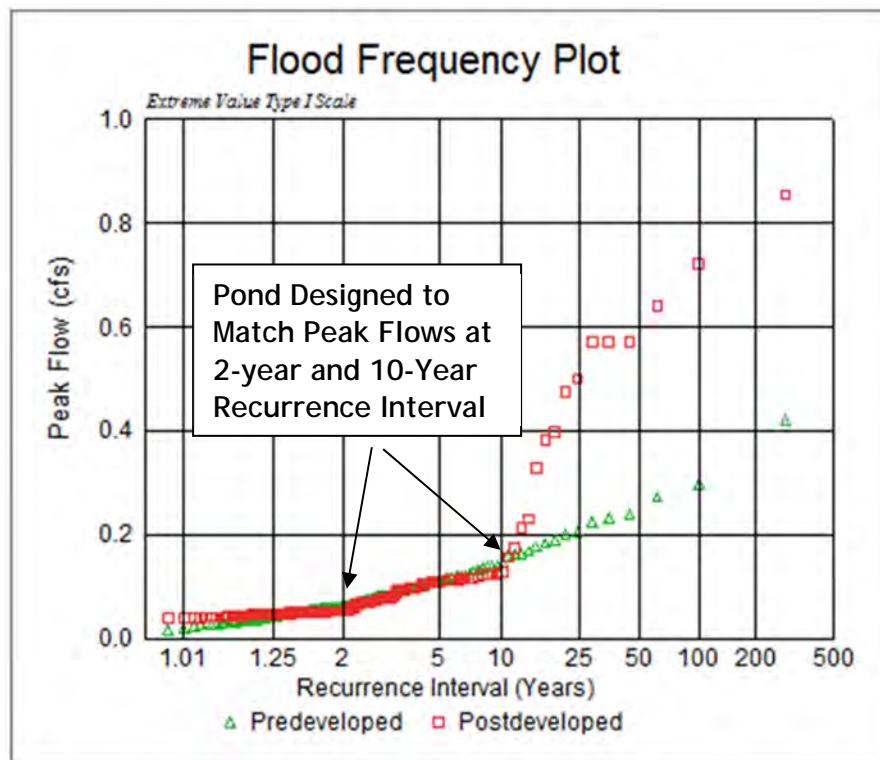

Figure F.3. Example Flood-Frequency Curves for a Stormwater Pond Designed to Control Post-Developed Peak Discharge Rates to Pre-Developed Levels at the 2-Year and 10-Year Recurrence Interval.

Flow Duration Standard

Flow duration statistics provide a convenient tool for characterizing stormwater runoff computed with a continuous hydrologic model. Examples of this type of standard are the Pre-developed Forest Standard and the Pre-developed Pasture Standard. [Evaluation of a flow duration design standard requires continuous simulation to compute the pre-development and post-development runoff record.](#) Duration statistics are computed by tracking the fraction of total simulation time that a specified flow rate is equaled or exceeded. Continuous rainfall-runoff models do this by dividing the range of flows simulated into discrete increments, and

then tracking the fraction of time that each flow is equaled or exceeded. For example, Figure F.4 shows a 1-year flow time series computed at hourly time steps from a 10-acre forested site and Figure F.5 shows the flow duration curve computed from this time series.

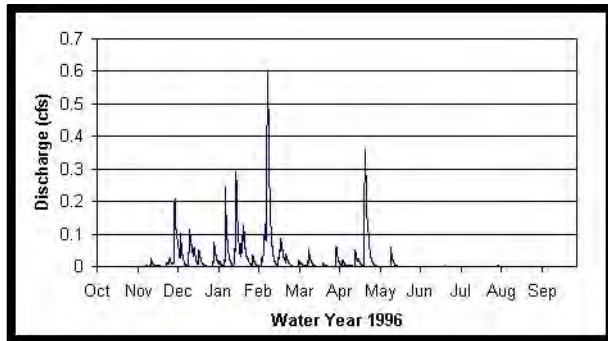

Figure F.4. Runoff from 10-Acre Forested Site.

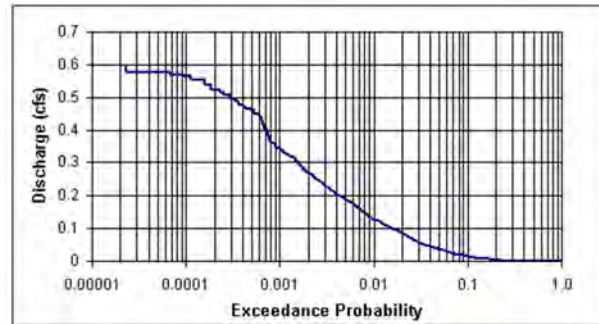

Figure F.5. Flow Duration Curve Computed Using Time Series in Figure F.4.

The fraction of time is termed “exceedance probability” because it represents the probability that a particular flow rate will be equaled or exceeded. It should be noted that exceedance probability for duration statistics is different from the “annual exceedance probability” associated with flood frequency statistics and there is no practical way of converting/relating annual exceedance probability statistics to flow duration statistics.

The flow duration standard can be viewed graphically as shown in Figure F.6. The flow duration curve for the site under pre-developed conditions is computed and is the target to which the post-developed flow duration curve is compared. The flow duration curve for the pond discharge must match the applicable pre-developed curve between 50 percent of the pre-developed 2-year ($0.5 Q_2$) and an upper limit, either the 2-year (Q_2) or the 50-year (Q_{50}) depending on the flow duration design standard for the facility.

Specified flow levels for the Pre-developed Forest Standard are typically 50 percent of the pre-developed 2-year peak flow ($0.5 Q_2$), the pre-developed 2-year peak flow (Q_2), and the pre-developed 50-year peak flow (Q_{50}) plus 97 other incremental flow values between $0.5 Q_2$ and Q_{50} . Specified flow levels for the Pre-developed Pasture Standard are typically 50 percent of the pre-developed 2-year peak flow ($0.5 Q_2$) and the pre-developed 2-year peak flow (Q_2) plus 98 other incremental flow values between $0.5 Q_2$ and Q_2 .

Depending on the flow duration design standard applicable to the stormwater facility, three criteria are evaluated to determine if the standard has been met.

1. Post-development flow duration values may not exceed the pre-development flow duration values between 50 percent of the pre-developed 2-year peak flow ($0.5 Q_2$) and the pre-developed 2-year peak flow (Q_2).
2. Post-development flow duration values may not exceed pre-development flow duration values between the pre-developed 2-year peak flow (Q_2) and the pre-developed 50-year peak flow (Q_{50}) by more than 10 percent, i.e., a post-development flow duration value may be up to 110 percent of the corresponding pre-development flow duration value.

3. [Post-development flow duration values may not exceed pre-development flow duration values for more than 50 percent of flow duration levels, i.e., not more than half of the post-development flow duration values may exceed 100 percent of the corresponding pre-development flow duration value.](#)

General guidance for adjusting the geometry and outlets of stormwater ponds to meet the duration standard were developed by King County (1999) and are summarized in Figure F.7 and described below. Refinements should be made in small increments with one refinement at a time. In general, the recommended approach is to analyze the duration curve from bottom to top, and adjust orifices from bottom to top. Inflection points in the outflow duration curve occur when additional structures (e.g., orifices, notches, overflows) become active. Refer to *Volume 3, Chapter 5* for complete facility design and sizing requirements.

Step #	Parameter	Procedure
P-1	Bottom Orifice Size	Adjust the bottom orifice to control the bottom arc of the post-developed flow duration curve. Reducing the bottom orifice discharge lowers and shortens the bottom arc while increasing the bottom orifice raises and lengthens the bottom arc.
P-2	Height of Second Orifice	The invert elevation of the second orifice affects the point on the flow duration curve where the transition (break in slope) occurs from the curve produced by the low-level orifice. Lower the invert elevation of the second orifice to move the transition point to the right on the lower arc. Raise the height of the second orifice to move the transition point to the left on the lower arc.
P-3	Second Orifice Size	The upper arc represents the combined discharge of both orifices. Adjust the second orifice size to control the arc of the curve for post-developed conditions. Increasing the second orifice raises the upper arc while decreasing the second orifice lowers the arc.
P-4	Pond Volume	Adjust the pond volume to control the upper end of the duration curve. Increase the pond volume to move the entire curve down and to the left to control riser overflow conditions. Decrease the pond volume to move the entire curve up and to the right to ensure that the outflow duration curve extends up to the riser overflow.

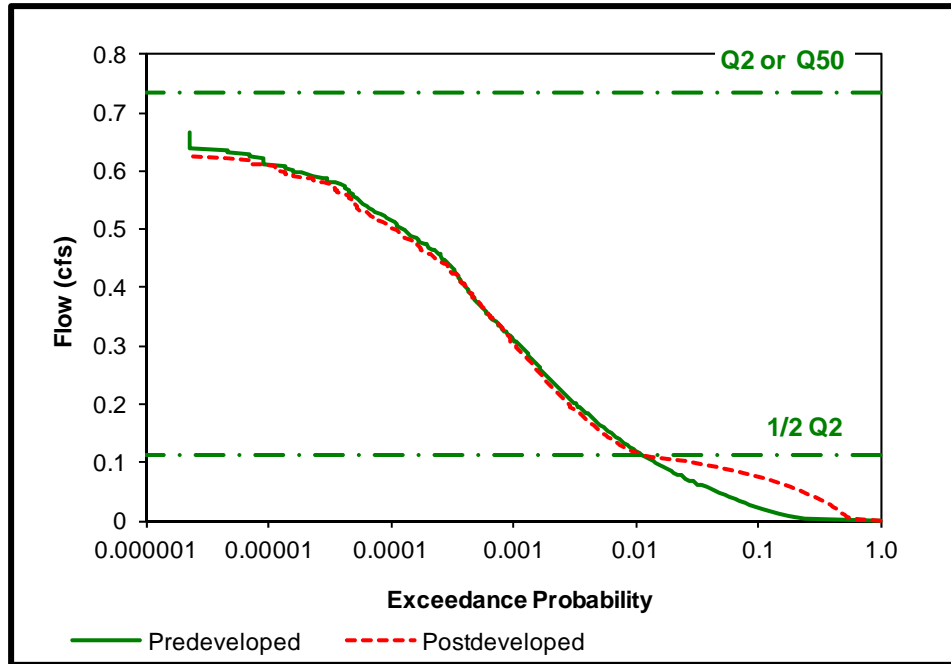

Figure F.6. Comparison of Pre-Developed and Post-Developed Flow Duration Curves.

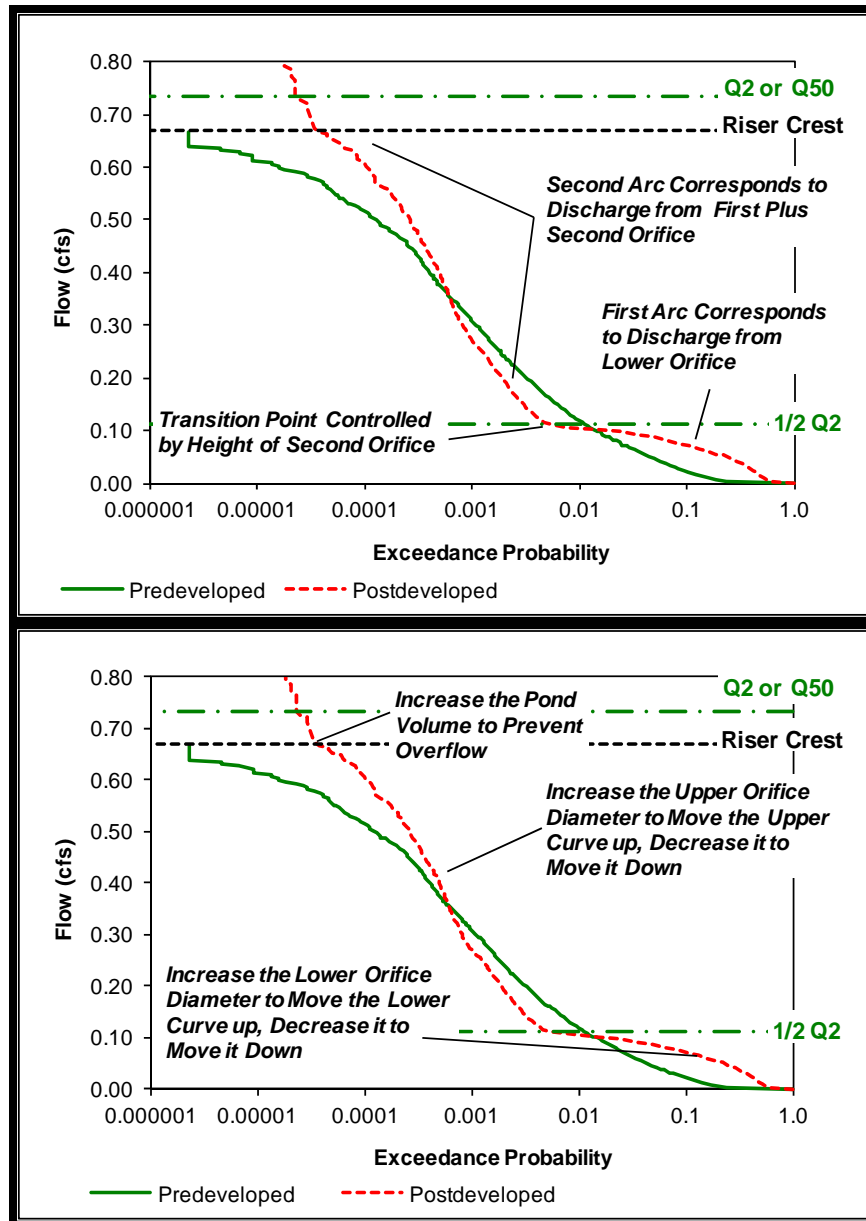

Figure F.7. General Guidance for Adjusting Pond Performance.

On-site Performance Standard BMP Design

This section provides guidance for sizing BMPs to meet the On-site Performance Standard. If the applicant chooses to use the On-site List Approach, modeling is typically not required (refer to sizing requirements in Chapter 5 of Volume 3). If the applicant chooses to use the On-site Performance Standard, the modeling procedures will depend upon the applicable target (i.e., forest or pasture). See Volume 3, Section 5.2.1 to determine the target based on the percent of existing hard surface and the type of drainage basin.

If the project discharge durations must match pre-developed forest flow durations for from 8 percent to 50 percent of the 2-year pre-developed flow, the procedures outlined above in the *Flow Duration Standard* subsection are generally applicable (with duration bounds revised

to 8 percent to 50 percent of the 2-year flow). Both WWHM and MGSFlood have the capability to evaluate (and report “pass” and “fail”) for this standard.

If the project discharge durations must match pre-developed pasture flow durations for the range of pre-developed discharge rates between the 1 percent and 10 percent exceedance values, the procedures outlined in this section are applicable.

The “frequency of exceedance” or “percent exceedance” (as referenced in the [Stormwater Code](#)), is the percent of time, over the simulation period (e.g., 158 years), that a given flow is equaled or exceeded. MGSFlood and WWHM both report “exceedance probability”- the decimal equivalent of “percent exceedance.” For example, the 1 to 10 percent exceedance range corresponds to the 0.01 and 0.1 exceedance probabilities displayed on the flow duration curves (see Figure F.7a). The standard is achieved if the post-developed flows are less than the pre-developed flows for the 1 to 10 percent exceedance range (red line is beneath the green line for the shaded range of exceedance values).

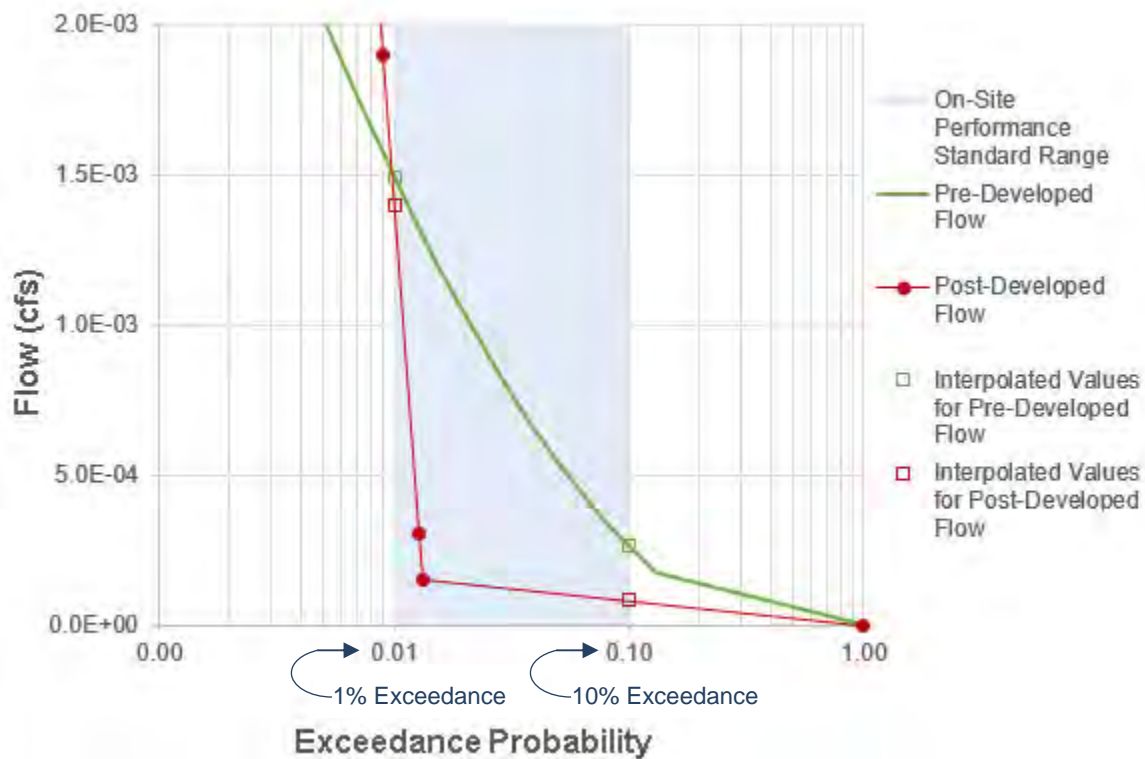

Figure F.7a. On-site Performance Standard Duration Curve.

[The latest versions of MGSFlood \(as of April 2021\) include the option to conduct a flow duration analysis based on the 1 to 10 percent exceedance standard. An MGSFlood user can select the option on the LID Duration tab in the Options menu. MGSFlood will then report “pass” or “fail” for the 1 to 10 percent exceedance standard. Neither MGSFlood nor WWHM does not currently \(as of April 2021/February 5, 2016\) explicitly report “pass” or “fail” for the 1 to 10 percent exceedance standard. However, WWHM allows the user to define the bounds of duration analysis in term of flow rate \(cubic feet per second\). A user can calculate the pre-developed pasture 1 and 10 percent exceedance flow rates using the software and manually](#)

[enter them as the bounds for the flow duration analysis on the Duration Criteria tab in the Options menu. WWHM will then report “pass” or “fail” for the 1 to 10 percent exceedance standard. We anticipate that, in the near future, both models will be updated to evaluate this standard internally. For users with different or older software in the interim, the following procedures may be used to determine compliance with Seattle Stormwater Code. Details are provided for determining compliance with both MGSFlood and WWHM but similar procedures may be applicable to other software programs.](#)

Visual Evaluation of On-site Performance Standard in MGSFlood

Compliance with the 1 to 10 percent exceedance standard may be confirmed by visually observing the MGSFlood Flow Duration Plot. The axes on the plot may be adjusted to clearly display the duration curve from 1 to 10 percent exceedance. Step-by-step instructions are provided below.

1. Right click on the Flow Duration Plot to open Duration Graph Settings
2. Select “Axis” tab
3. Edit x-axis scale (select “X”, “User Defined”)
4. Update x-axis range of values as follows:
 - a. Max = 0.1
 - b. Min = 0.01
 - c. Ticks = 1

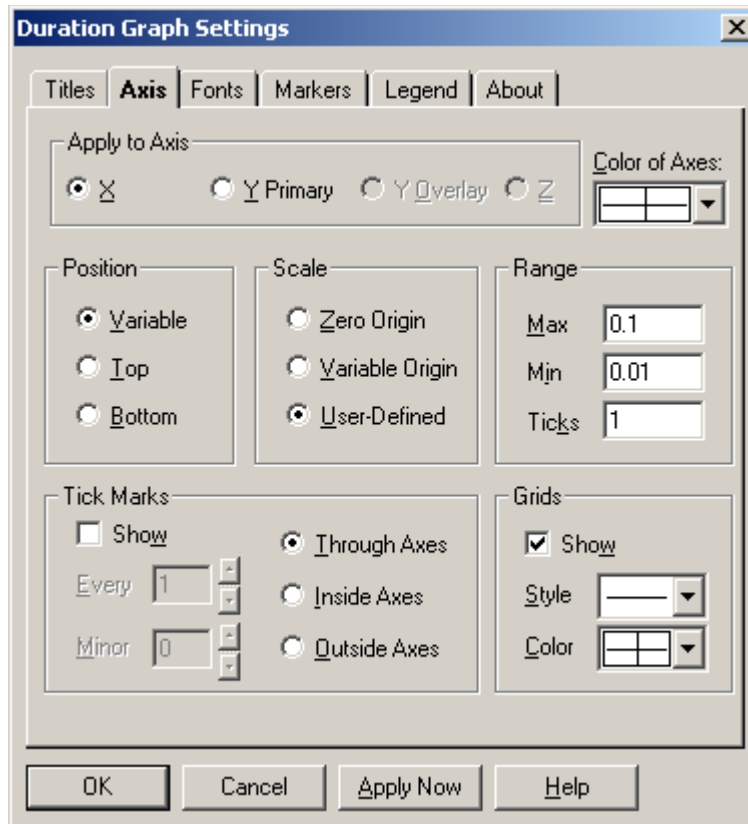

5. Edit y-axis scale (select "Y Primary," "User Defined")

- Update y-axis range of values. Values will vary depending on size of contributing area.

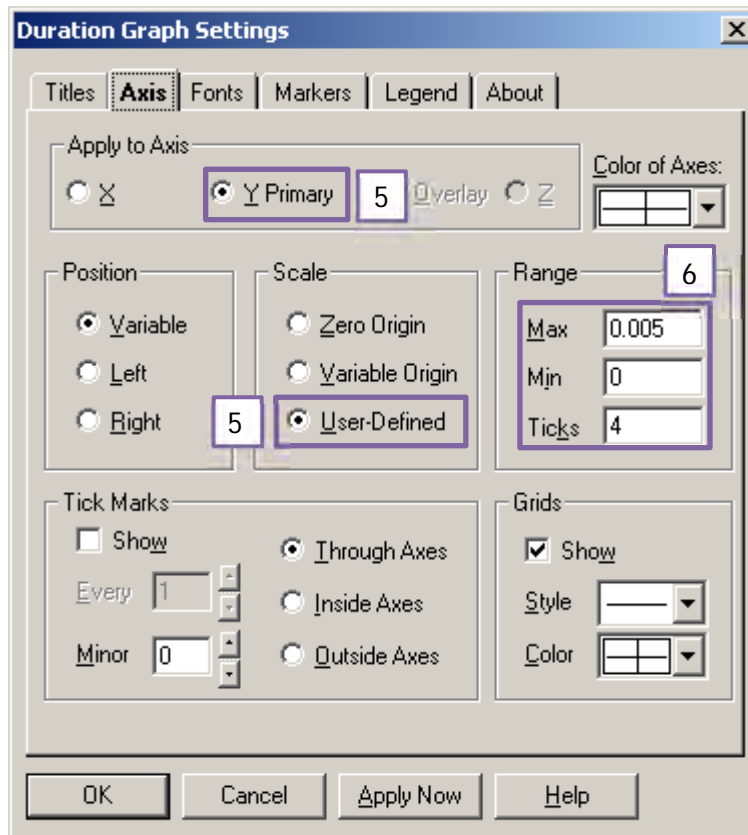

7. Visually inspect to confirm that the post-developed flows are less than the pre-developed flows for the 1 to 10 percent exceedance range (red line is beneath the green line for the range plotted).

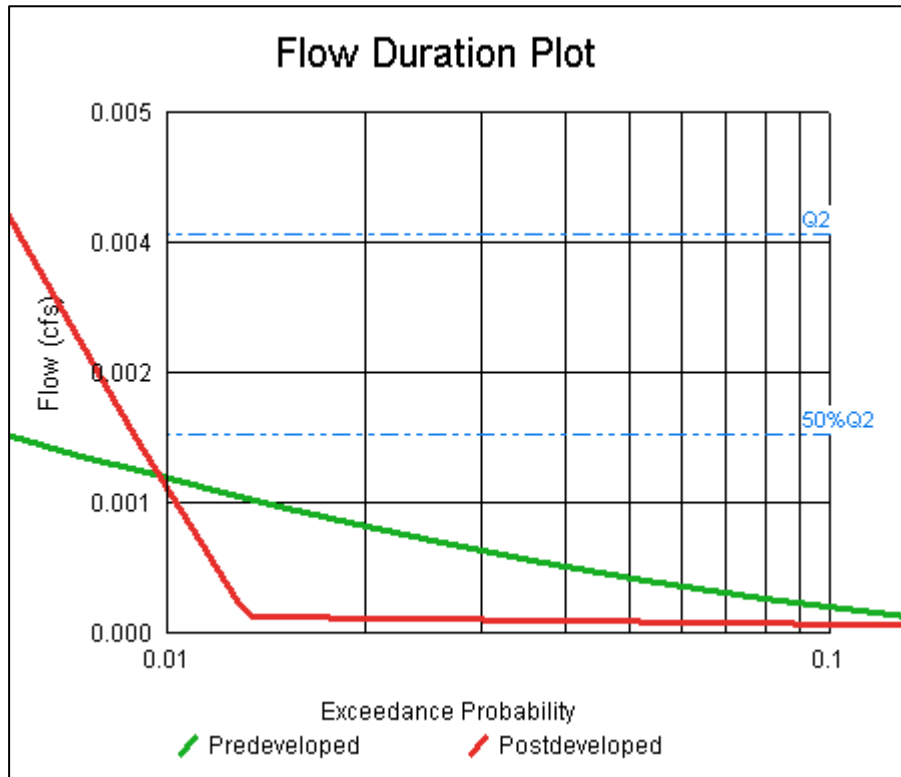

Quantitative Evaluation of the On-site Performance Standard in MGSFlood

If the user wishes to fully optimize BMP sizes for the 1 to 10 percent exceedance standard, values must be calculated and evaluated outside of the model. Step-by-step procedures are provided below with an example:

1. Build and run the model
2. View report file (File>View Report)
3. Select "Full Output" to get full detailed report and click "Refresh"
4. Navigate to "Point of Compliance Flow Duration Data"
5. Determine pre-developed flows associated with 1 percent and 10 percent exceedance probability using the steps below. Note that a higher probability of exceedance corresponds to lower, more frequent, flows.
 - a. Identify the exceedance probability values immediately higher and immediately lower than the 1 percent exceedance. Record the exceedance probabilities and the associated flows as shown in the example below:

	Pre-development Runoff Discharge (cfs)	Exceedance Probability
Higher than 1%	1.37E-03	1.19%
Lower than 1%	1.54E-03	0.94%

6. Identify the exceedance probability values immediately higher and immediately lower than the 10 percent exceedance. Record the exceedance probabilities and the associated flows as shown in the example below:

	Pre-development Runoff Discharge (cfs)	Exceedance Probability
Higher than 10%	1.71E-04	13.15%
Lower than 10%	3.42E-04	7.97%

7. Logarithmically interpolate flows associated with the 1 and 10 percent exceedance probabilities using Equation 1 and Equation 2, respectively.

$$Flow_{1\%} = Flow_{lower} + \frac{Flow_{lower} - Flow_{higher}}{\log(Exceedance_{lower}) - \log(Exceedance_{higher})} \times [\log(1\%) - \log(Exceedance_{lower})] \quad \text{Eq 1.}$$

$$Flow_{10\%} = Flow_{lower} + \frac{Flow_{lower} - Flow_{higher}}{\log(Exceedance_{lower}) - \log(Exceedance_{higher})} \times [\log(10\%) - \log(Exceedance_{lower})] \quad \text{Eq 2.}$$

Results for this example are shown below:

	Pre-development Runoff Discharge (cfs)	Exceedance Probability
Interpolated flows at 1%	1.49E-03	1.00%
Interpolated flows at 10%	2.64E-04	10.00%

8. Determine post-developed flows associated with 1 percent and 10 percent exceedance probability. Repeat Steps 5a, 5b, and 5c using post-developed flows.

	Post-development Runoff Discharge (cfs)	Exceedance Probability
Interpolated flows at 1%	1.40E-03	1.00%
Interpolated flows at 10%	8.16E-05	10.00%

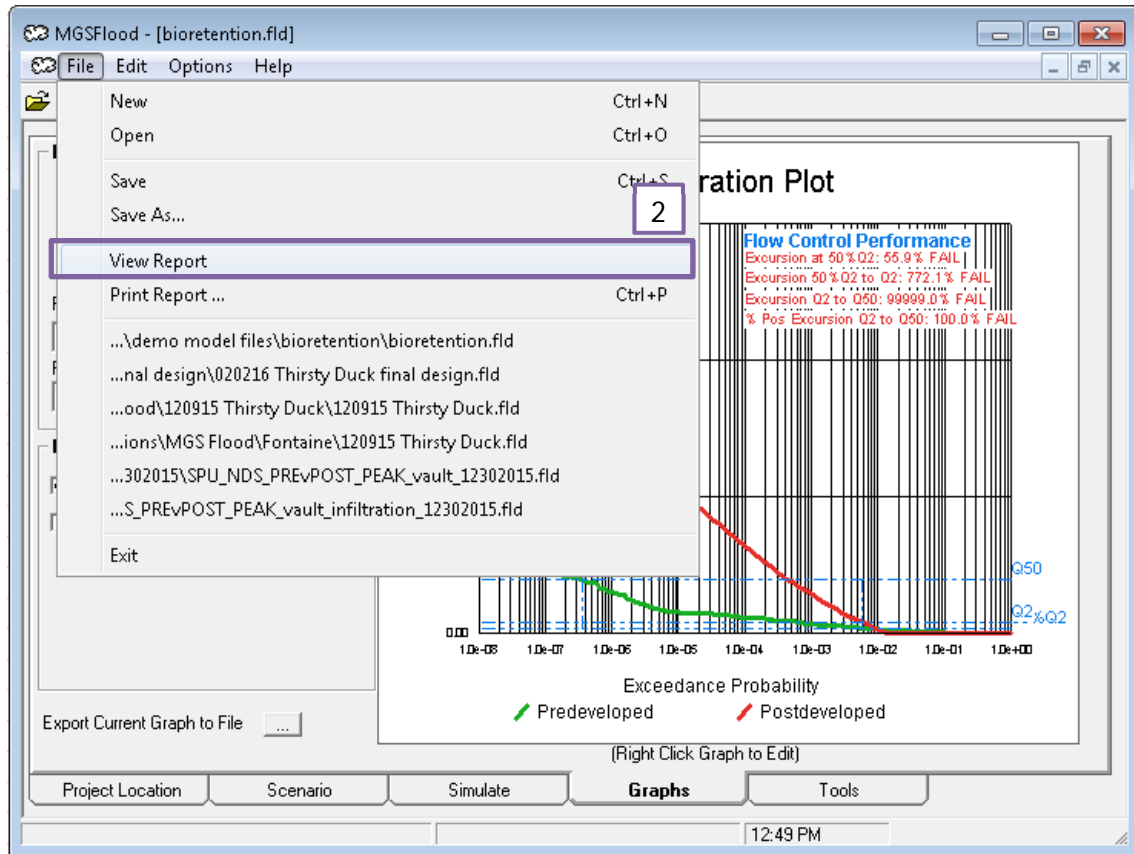

Summary Report

*** Point of Compliance Flow Duration Data ***

Predevelopment Runoff		Postdevelopment Runoff	
Discharge (cfs)	Exceedance Probability	Discharge (cfs)	Exceedance Probability
0.000E+00	1.0000E+00	0.000E+00	1.0000E+00
1.708E-04	1.3153E-01	1.528E-04	1.3408E-02
3.417E-04	7.9651E-02	3.056E-04	1.2772E-02
5.125E-04	5.2827E-02	1.894E-03	8.9475E-03
6.834E-04	3.6934E-02	2.525E-03	7.8439E-03
8.542E-04	2.6978E-02	3.157E-03	6.8956E-03
1.025E-03	2.0119E-02	3.820E-03	5.9901E-03
1.196E-03	1.5285E-02		-03
1.367E-03	1.1882E-02		-03
1.538E-03	9.3564E-03		-03
1.708E-03	7.4473E-03		-03
1.910E-03	5.7199E-03	6.945E-03	3.2085E-03
2.050E-03	4.8110E-03	7.615E-03	2.8183E-03
2.221E-03	3.8998E-03	8.208E-03	2.5351E-03
2.392E-03	3.1807E-03	8.839E-03	2.2812E-03
2.563E-03	2.5968E-03	9.470E-03	2.0536E-03
2.733E-03	2.1169E-03	1.010E-02	1.8602E-03
2.904E-03	1.7104E-03	1.073E-02	1.6888E-03
3.075E-03	1.4057E-03	1.136E-02	1.5407E-03
3.246E-03	1.1695E-03	1.200E-02	1.4010E-03
3.417E-03	9.9161E-04	1.263E-02	1.2808E-03

Report Output Level

Minimal Output (Compliance Statistics Only)
 Moderate Output (Includes Stats at All Locations)
 Full Output (Includes Stat Tables, Hydraulic Rating Tables)

Include Flow Duration Compliance Statistics
 Include LID Duration Compliance Statistics

Refresh Close

9. Compare pre-developed flows and post-developed flows at 1 and 10 percent exceedance probabilities and visually confirm, from the flow duration curves in the model, that the post-developed flows are smaller than the pre-developed flows. If post-developed flows at the 1 or 10 percent exceedance probability are higher than the pre-developed flows, or if the post developed flows appear to exceed the pre-developed flows for the 1 to 10 percent exceedance range of the duration curve (refer to procedures for visual observation, above), increase the BMP size(s), run the model, and repeat Steps 2 through 9.

See Figure F.7a for a comparison of pre-and post-developed flow duration curves for the target exceedance probability range. Figure F.7a also includes the interpolated data points described above, shown as hollow squares on the graph. If post-developed flows (shown in red) are smaller than pre-developed flows (shown in green) for the target exceedance probability range (grey hatch), the project satisfies the On-site Performance Standard.

Visual Evaluation of On-site Performance Standard in WWHM

Compliance with the 1 to 10 percent exceedance standard may be estimated by visually observing the WWHM Stream Protection Duration Plot. The axes on the plot must be adjusted and manually evaluated to more clearly display the duration curve from 1 to 10 percent exceedance. Because the graphs are difficult to accurately read, the facility may need to be somewhat oversized to visually confirm compliance. Step-by-step instructions are provided below:

1. Build and run the model
2. View the “Stream Protection Duration” results in the Analysis tab window
3. Select the appropriate points of compliance for the pre-developed scenario and the mitigated (i.e., post-developed) scenario under “All Datasets” (hold CTRL to select more than one)
 - 501 POC 1 Predeveloped flow*
 - 801 POC 1 Mitigated flow*
4. Modify the “Duration Bounds” to include the 1 and 10 percent exceedance values
 - a. Minimum = 0 cfs
 - b. Maximum = established by trial and error until the pre-developed flows corresponding to the 1 percent exceedance are visible on the graph. To optimize the facility size(s), set the maximum value slightly above the predeveloped flow that is exceeded 1 percent of the time. This value can be approximated as the contributing area in acres times 0.00025 cfs per acre.
5. Select the “Stream Protection Duration” tab to re-calculate the results with the new duration bounds

6. Visually inspect the duration plot to confirm that the mitigated flows are smaller than the pre-developed flows for the 1 to 10 percent exceedance range. Because the plots are difficult to accurately read, the following steps are required to confirm compliance with the 1 to 10 percent exceedance standard:
 - a. Take a screenshot of the flow duration curve
 - b. Paste the screenshot into a word processing software, e.g., [Microsoft Word](#)
 - c. Overlay two vertical lines at the 1% and 10% tick marks
 - d. Confirm the mitigated flows (red line) are below the pre-developed flows (blue line) within the range of the two horizontal lines. Note: to visually ensure compliance, the facility may need to be somewhat oversized (the screenshot shown below is 10 percent larger than required when quantitative evaluated using the procedure provided below).

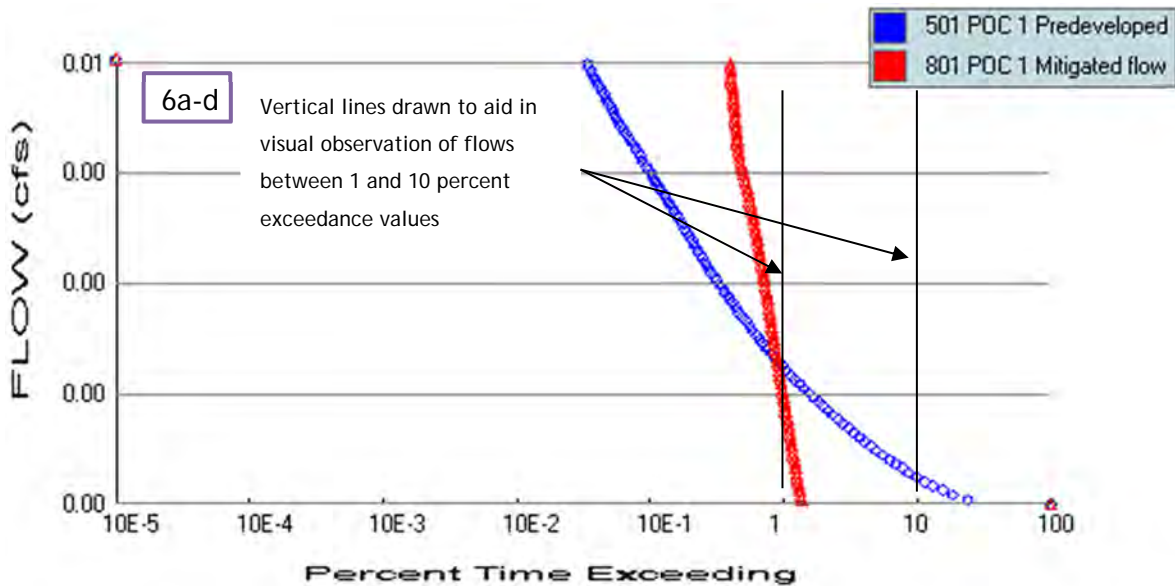
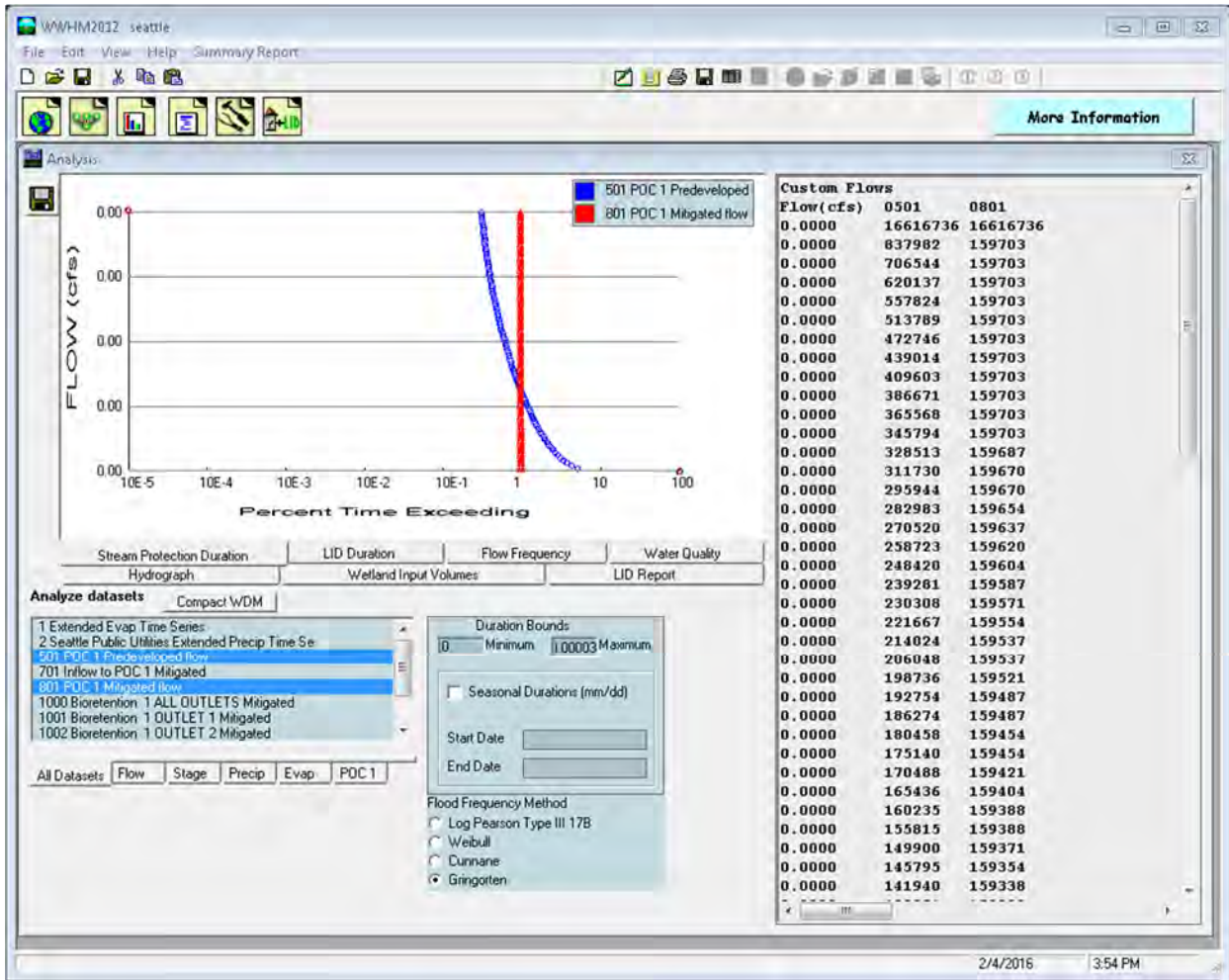

Evaluation of the On-site Performance Standard in WWHM

To quantitatively evaluate and fully optimize BMP sizes for the 1 to 10 percent exceedance standard, values must be calculated and evaluated outside of the model. Step-by-step procedures are provided below with an example:

1. Build and run the model
2. View the “Stream Protection Duration” results in the Analysis tab window
3. Select the appropriate points of compliance for the pre-developed scenario and the mitigated (i.e., post-developed) scenario under “All Datasets” (hold CTRL to select more than one)

501 POC 1 Predeveloped flow

801 POC 1 Mitigated flow

4. Modify the “Duration Bounds” to include the 1 and 10 percent exceedance values
 - a. Minimum = 0 cfs
 - b. Maximum = established by trial and error until the pre-developed flows corresponding to the 1 percent exceedance are visible on the graph. To optimize the facility size(s), set the maximum value slightly above the predeveloped flow that is exceeded 1 percent of the time. This value can be approximated as the contributing area in acres times 0.00025 cfs per acre.

$$0.12 \text{ acres} \times 0.00025 \text{ cfs/acre} = 0.00003$$

5. Select the “Stream Protection Duration” tab to re-calculate the results with the new duration bounds
6. Determine the total number of timesteps calculated by the model. Refer to the first line in the “Custom Flows” table (i.e., number of timesteps associated with a flow of zero cfs [flow at every timestep is greater than or equal to zero cfs]).

Custom Flows		
Flow(cfs)	0501	0801
0.0000	16616736	16616736

7. Calculate the number of timesteps that correspond to the 1 percent and 10 percent exceedance values using Equations 3 and 4

$$1 \text{ Percent of Timesteps} = \text{Total number of Timesteps} \times 0.01 \quad \text{Eq 3.}$$

$$10 \text{ Percent of Timesteps} = \text{Total number of Timesteps} \times 0.1 \quad \text{Eq 4.}$$

$$1 \text{ Percent of Timesteps} = 16,616,736 \times 0.01 = 166,167$$

$$10 \text{ Percent of Timesteps} = 16,616,736 \times 0.1 = 1,661,674$$

8. Compare pre-developed flows and post-developed (i.e., mitigated) flows at the 1 percent exceedance probability. While the flow values themselves are often too small to display in the “Custom Flows” table in WWHM, the number of timesteps a

given flow is exceeded can be used to evaluate facility performance relative to the pre-developed condition. For the On-site Performance standard, all flows with a probability of exceedance from 1 to 10 percent should be exceeded at the same frequency, or less frequently than the predeveloped condition. In other words, for a given flow in the target range, the number of timesteps that flow is exceeded should be fewer in the mitigated scenario than the pre-developed scenario. To compare the pre-developed and mitigated flows:

- a. Identify the flow values immediately higher and immediately lower than the target 1 percent of timesteps (as determined in Step 7) for the pre-developed scenario
- b. Compare the number of timesteps these flow values are exceeded in the mitigated scenario to the pre-developed scenario.
- c. If the pre-developed scenario is exceeded less frequently than the mitigated scenario, increase facility size and repeat Step 8.
- d. Proceed to Step 9.

Custom Flows		
Flow(cfs)	0501	0801
0.0000	170488	159421
0.0000	165436	159404

The first flow is exceeded for 170,488 timesteps ($170,488/16,616,736 = 1.03\%$) in the pre-developed condition. The second flow is exceeded for 165,436 timesteps ($165,436/16,616,736 = 0.996\%$) in the pre-developed condition. For these flows, the mitigated scenario is exceeded for a fewer number of timesteps than the pre-developed scenario, therefore the mitigated condition meets the On-site Performance Standard at the 1 percent exceedance value.

9. Compare pre-developed flows and post-developed (i.e., mitigated) flows at the 10 percent exceedance probability:
 - a. Identify the flow values immediately higher and immediately lower than the target 10 percent of timesteps (as determined in Step 7) for the pre-developed scenario.
 - b. Compare the number of timesteps these flow values are exceeded in the mitigated scenario to the pre-developed scenario.
 - c. If the pre-developed scenario is exceeded less frequently than the mitigated scenario, increase facility size and repeat Step 9.
 - d. Proceed to Step 10.

Custom Flows		
Flow(cfs)	0501	0801
0.0000	16616736	16616736
0.0000	837982	159703

The first flow is exceeded for 16,616,736 timesteps (16,616,736/16,616,736 = 100%) for both the pre-developed scenario and the mitigated scenario. The second flow is exceeded for 837,982 timesteps (837,982/16,616,736 = 5.04%) in the pre-developed condition and is exceeded for 21,134 timesteps in the mitigated condition. Therefore the mitigated condition meets the on-site standard at the 10 percent exceedance value.

10. Visually confirm, from the flow duration curves in the model, that the mitigated flows are smaller than the pre-developed flows for the 1 to 10 percent exceedance range. If the post developed flows appear to exceed the pre-developed flows for the 1 to 10 percent exceedance range of the duration curve, increase the BMP size(s) and repeat Steps 8 through 10.

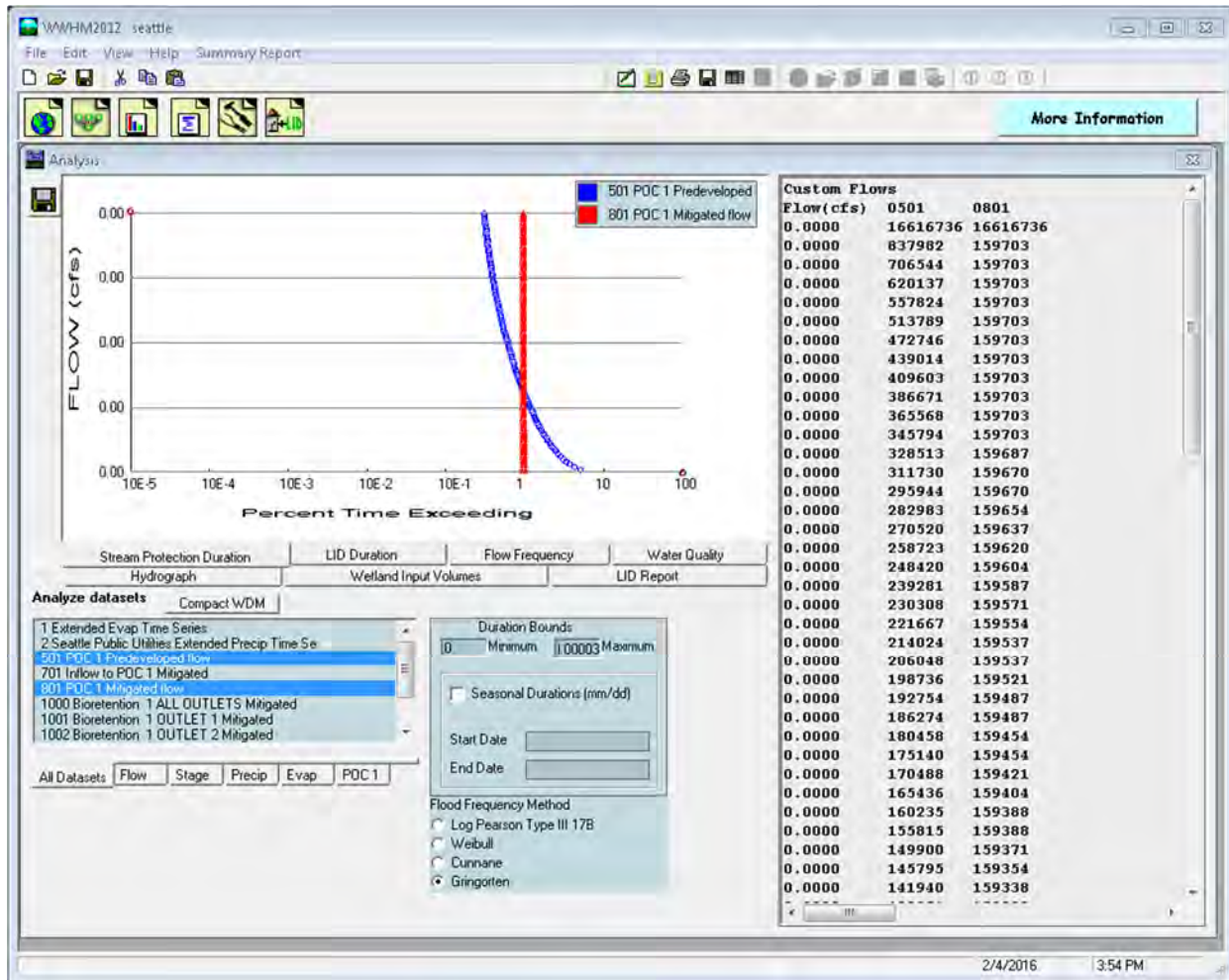

Water Quality Treatment BMP Design

Water Quality Design Volume

The water quality design volume for sizing wet ponds is computed as the daily runoff volume that is greater than or equal to 91 percent of all daily values in the simulation period. The continuous model develops a daily runoff time series from the pond inflow time series and scans the computed daily time series to determine the 24-hour volume that is greater than or equal to 91 percent of all daily values in the time series. This value is then used as the volume for a “Basic Wet Pond” and 1.5 times this value is used for sizing a “Large Wet Pond.”

The water quality design volume is defined as the daily runoff volume at which 91 percent of the total runoff volume is produced by smaller daily volumes. The procedure can be visualized using Figure F.8 below. The bars on the graph represent daily inflow volume for the entire simulation. The time span along the x-axis in Figure F.8 is for 105 days, but in practice, this would include the entire simulated inflow time series ([e.g.](#), 158 years).

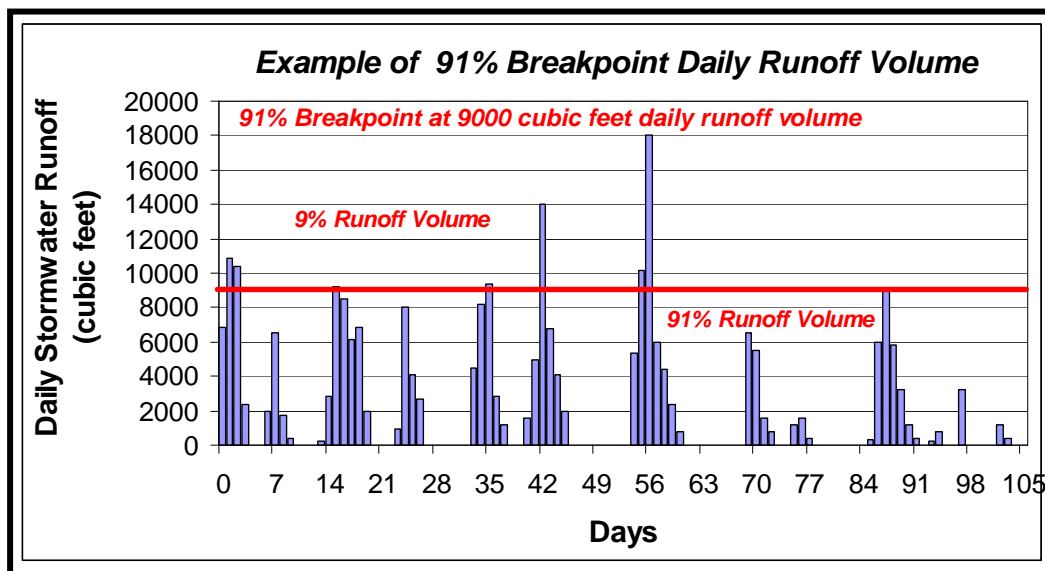

Figure F.8. Example of Portion of Time-Series of Daily Runoff Volume and Depiction of Water Quality Design Volume.

The horizontal line represents the water quality design volume. Its value is calculated such that 91 percent of the total daily runoff volume for the entire simulation resides below this line and 9 percent of the total daily runoff volume for the entire simulation exceeds the water quality design volume. Stated another way, if you total the daily runoff volumes that exceed the 9,000 cubic foot water quality design volume, they represent 9 percent of the total runoff volume.

The process for computing this water quality design volume may vary among continuous simulation models. An example of a typical approach used to compute the water quality design volume (WQDV) is summarized below.

Step #	Procedure
WQDV-1	Compute daily volume to the pond using the inflow time (convert the inflow rate to inflow volume on a midnight to midnight basis using a 1-hour or less time step).
WQDV-2	Compute the total inflow volume by summing all of the daily inflow volume values for the entire simulation.
WQDV-3	Compute a breakpoint value by multiplying the total runoff volume computed in Step WQDV-2 by 9 percent.
WQDV-4	Sort the daily runoff values from Step WQDV-1 in descending order (highest to lowest).
WQDV-5	Sum the sorted daily volume values until the total equals the 9 percent breakpoint. That is, the largest volume is added to the second largest, which is added to the third largest, etc., until the total equals the 9 percent breakpoint.
WQDV-6	The last daily value added to match the 9 percent breakpoint is defined as the water quality design volume.

Water Quality Treatment Design Flow Rate

The flow rate used to design flow rate dependent treatment facilities depends on whether or not the treatment is located upstream of a stormwater detention facility and whether it is an on-line or offline facility (Figure F.9).

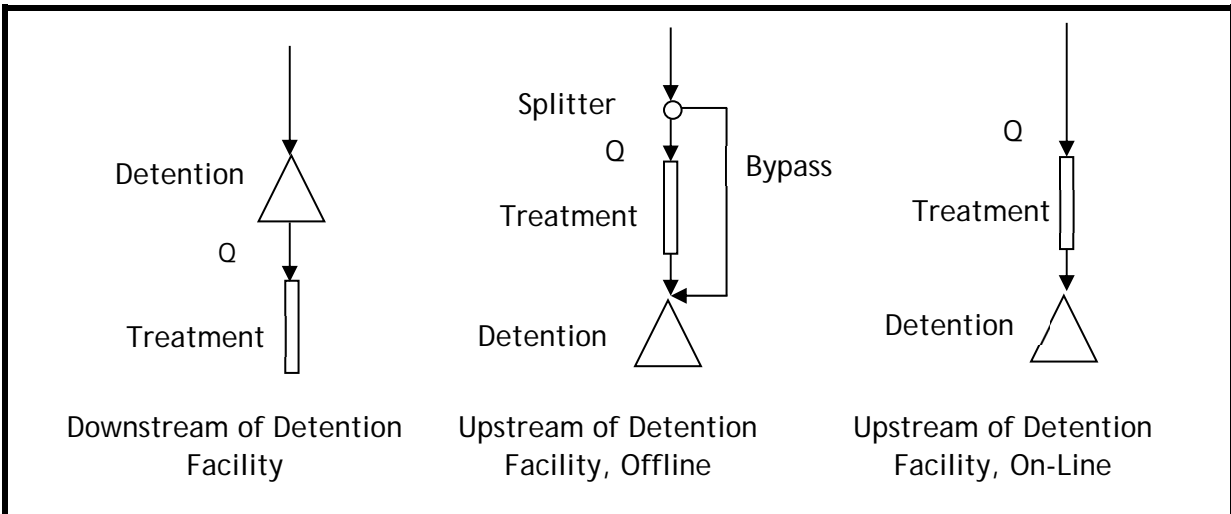

Figure F.9. Water Quality Treatment and Detention Definition.

Downstream of Detention Facilities: If the treatment facility is located downstream of a stormwater detention facility, then the water quality design flow rate is the release rate from the detention facility that has a 50 percent annual probability of occurring in any given year (2-year recurrence interval).

Upstream of Detention Facilities, Offline: Offline water quality treatment located upstream of the detention facility includes a high-flow bypass that routes the incremental flow in excess of the water quality design rate around the treatment facility. It is assumed that flows from the bypass enter the system downstream of the treatment facility but upstream of the detention facility. The continuous model determines the water quality treatment design flow rate as the rate corresponding to the runoff volume that is greater than or equal to

91 percent of the 15-minute runoff volume entering the treatment facility (Figure F.10). If runoff is computed using the City of Seattle Design Time Series with a time step of 15 minutes or less, then no time step adjustment factors are need for the water quality design discharge.

Upstream of Detention Facilities, On-line: On-line water quality treatment does not include a high-flow bypass for flows in excess of the water quality design flow rate and all runoff is routed through the facility. The continuous model determines the water quality treatment design flow rate as the rate corresponding to the runoff volume that is greater than or equal to 91 percent of the 15-minute runoff volume entering the treatment facility. However, those flows that exceed the water quality design flow are not counted as treated in the calculation (Figure F.11). Therefore, the design flow rate for on-line facilities is higher than for offline facilities. If runoff is computed using the City of Seattle Design Time Series with a time step of 15 minutes or less, then no time step adjustment factors are need for the water quality design discharge.

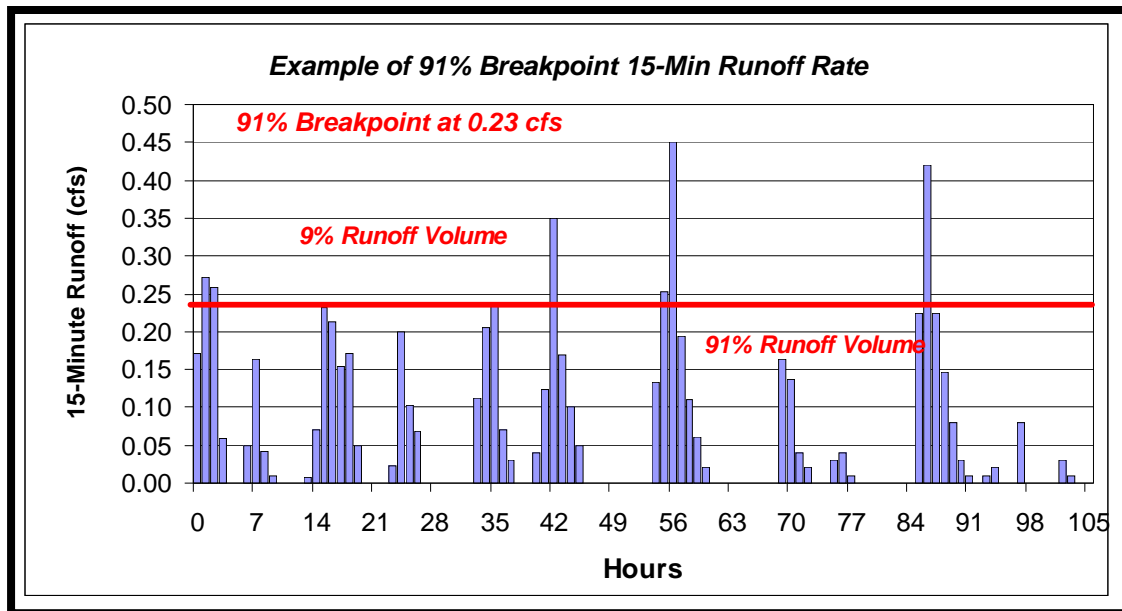

Figure F.10. Offline Water Quality Treatment Discharge Example.

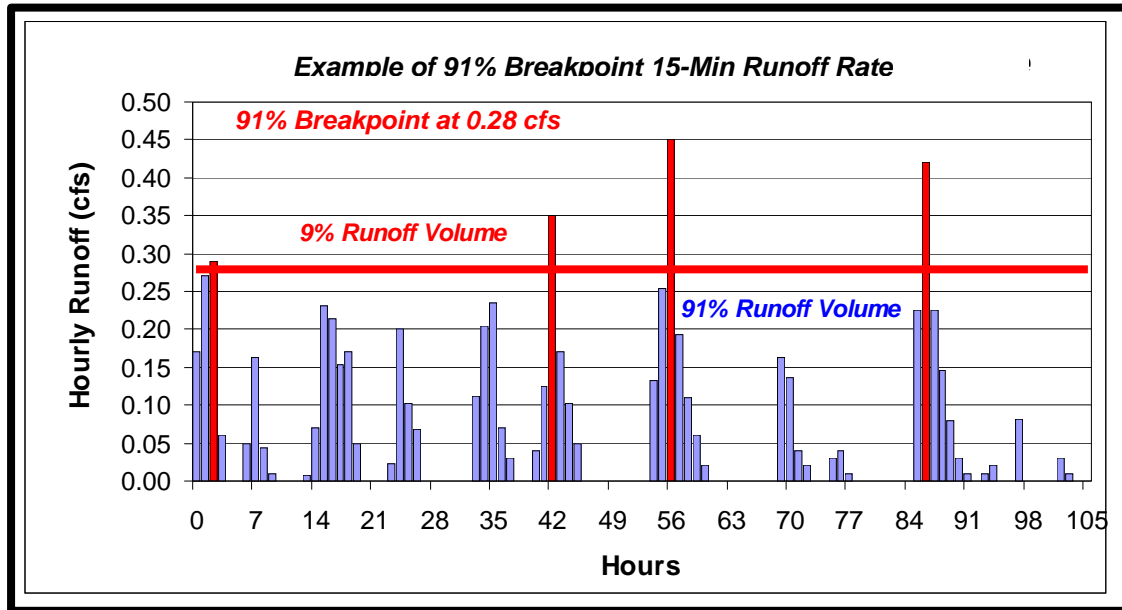

Figure F.11. On-Line Water Quality Treatment Discharge Example.

Infiltration Facilities Providing Water Quality Treatment: Infiltration facilities designed for water quality treatment must infiltrate 91 percent of the total runoff volume through soil meeting the treatment soils requirements outlined in *Volume 3, Section 4.5.2*. The procedure is the same as for designing infiltration for flow control, except that the target is to infiltrate 91 percent of the runoff file without overflow (refer to *Volume 3, Section 4.5.1*). In addition, to prevent the onset of anaerobic conditions, an infiltration facility designed for water quality treatment purposes must be designed to drain the water quality design volume within 48 hours. Drain time can be calculated by using a horizontal projection of the infiltration basin mid-depth dimensions and the design infiltration rate.

Stormwater Conveyance

Storms that produce the highest rates of runoff from developed areas are typically shorter in duration and are characterized by brief periods of high intensity rainfall. A 5-minute time step (refer to Table F.12) is required to adequately simulate the runoff peak discharge and hydrograph shape resulting from these high-intensity storms. A 15-minute time step may be used if the time of concentration computed is 30 minutes or more. Follow the modeling steps outlined in *Steps for Hydrologic Design Using Continuous Models*, and for conveyance-specific designs also perform the following:

Step #	Procedure
SC-1	Identify downstream hydraulic controls, such as outfalls (refer to Outfalls in <i>Section F-3</i>), known flooding locations, receiving pipe hydraulic grade line (HGL), pump station, regulator station, weirs, or orifices. Determine if backwater calculations or a dynamic hydraulic routing model are required.
SC-2	Analyze flood frequencies and select the flows representing the level of conveyance service and/or flood protection required.
SC-3	Utilize the peak flows to size or assess the capacity of pipe systems, culverts, channels, spillways and overflow structures.

Step #	Procedure
SC-4	Perform a capacity analysis to verify that there is sufficient capacity in the public drainage system or the public combined sewer system. Refer to <i>Volume 3, Section 4.3</i> and SMC, Section 22.805.020.J for specific requirements.
SC-5	Size the pipe to convey the selected peak flows.

Using Continuous Simulation Hydrographs with Dynamic Routing Models

Continuous hydrologic models based on the HSPF program utilize hydrologic (also known as lumped) routing routines to determine the time and magnitude of flow of a watercourse. Because of this, these models cannot simulate complex hydraulics such as where the flow reverses direction or where a downstream channel or pipe influences another upstream in a time dependent way.

For simulation of complex hydraulics in pipe systems or tidally influenced boundaries, a dynamic routing hydraulic program, such as the SWMM Extran routine, may be necessary to accurately determine the discharge rate and the water surface elevation or hydraulic grade line (HGL). Flows simulated using the continuous hydrologic model may be exported and used as input to the dynamic routing hydraulic model.

Dynamic routing models solve the full unsteady flow equations using numeric approximation methods. These methods typically require computational time steps that are relatively short to maintain numerical stability, and it may not be practical to attempt routing of multi-year sequences of runoff produced by the continuous hydrologic model. To reduce the simulation time, flow hydrographs from specific storms of interest computed using the continuous flow model may be used rather than the entire simulated flow time series.

To utilize a dynamic routing model to route hydrographs computed with the continuous hydrologic model, the procedure described in the *Steps for Hydrologic Design Using Continuous Models* should be followed to create the runoff time series. The following additional steps should be followed to identify storms of a particular recurrence interval, export them from the continuous model, and import them into SWMM (or other dynamic routing model):

Step #	Procedure
DR-1	Delineate the watershed with subbasin outlets (runoff collection points) corresponding to the main inflows to the pipe system.
DR-2	Run the continuous hydrologic model for the full period of record. For most design applications, the City of Seattle Design Time Series should be used. The routing effects of the pipe or other conveyance system to be analyzed should not be included in the continuous hydrologic model.
DR-3	Use flood peak discharge statistics computed by the continuous model to identify when floods of various recurrence intervals occur in the simulated time series. Export hydrographs with peak discharge rates corresponding to desired recurrence intervals in a format that can be read by the hydraulic model.

For example, Table F.13 shows flood peak discharge-frequency results for a subbasin. If hydrographs corresponding to the 100-year, 25-year, and 10-year recurrence intervals were needed for conveyance design purposes, then simulated hydrographs with recurrence intervals closest to those required would be exported from the continuous hydrologic model

as indicated in the right column of the table. The hydrograph duration would include a period antecedent to the flood peak (typically several days to a week) and several days following the flood peak.

F-5. Single-Event Rainfall–Runoff Methods

Single-event models simulate rainfall-runoff processes for a single-storm, typically 2 hours to 72 hours in length and usually of a specified exceedance probability. Because the primary interest is the flood hydrograph, calculation of evapotranspiration, soil moisture changes between storms, and base flow processes are typically not needed. This is in contrast to continuous rainfall-runoff models (*Section F-4*) where multi-decade precipitation and evaporation time series are used as input to produce a corresponding multi-decade time series of runoff.

Precipitation input to single-event models can include either historical data recorded from a rain gauge or a synthetic design storm hyetograph. This section describes the use of both types of precipitation input.

Design Storm Hyetographs

Design storm hyetographs were developed using noteworthy storms that were recorded by the City of Seattle gauging network. NOAA Atlas 2 precipitation-frequency (isopluvial) maps published in the early 1970s have historically been used in hydrologic analysis and design. These maps are replaced in this manual by precipitation magnitude-frequency estimates more specific to the City of Seattle. These estimates are based on a regional analysis using data from the SPU Rain Gauge Network and gauges from the NOAA national cooperative gaging network in western Washington. The most recent analysis included data from 1940 to 2003. Attachment 2 provides the precipitation data based on the SPU Rain Gauge Network.

Table F.13. Example Simulated Peak Discharge Frequency Table and Hydrographs Exported to SWMM or Other Hydraulic Model for Desired Recurrence Intervals.

Flood Peak Recurrence Interval (years)	Date of Peak ^a	Peak Discharge Rate (cfs)	Desired Recurrence Interval for Analysis
282	06/10/2010	7.62	
101	11/04/1998	6.11	100-year
62	06/29/1952	6.06	
44	02/03/2062	5.38	
35	07/18/2043	4.71	
28	10/06/1981	4.64	
24	03/03/1950	4.54	25-year
21	01/09/1990	4.40	
18	09/30/2011	4.40	
17	11/24/1990	4.27	
15	08/24/2077	4.25	
14	05/03/2002	4.25	
13	10/27/2054	4.15	

Table F.13 (continued). Example Simulated Peak Discharge Frequency Table and Hydrographs Exported to SWMM or Other Hydraulic Model for Desired Recurrence Intervals.

Flood Peak Recurrence Interval (years)	Date of Peak ^a	Peak Discharge Rate (cfs)	Desired Recurrence Interval for Analysis
12	10/26/1986	4.03	
11	09/01/2061	3.93	
10	01/20/2013	3.92	10-year
9.6	08/23/1968	3.92	
9.0	01/14/2040	3.76	

^a Simulation was performed using SPU Design Time Series, which is 158 years in length, and has dates spanning 10/1/1939 through 9/30/2097. (Note: This table may be revised in a future version of the 2021 Seattle Stormwater Manual.)

Statistical analyses were conducted for the storm characteristics and dimensionless design storms were developed for short, intermediate, and long duration storm events (Schaefer 2004). The short, intermediate, and long duration design storms can be scaled to any site-specific recurrence interval using precipitation magnitudes at the 2-hour, 6-hour, and 24-hour duration.

Table F.14 summarizes the applicability of the four City design storms. If multiple storm types are listed for a particular application, then all applicable storm types should be considered candidates and used in the hydrologic model. The candidate storm that produces the most severe hydrologic loading and most conservative design is then adopted as the design storm. Note that this table does not override the modeling requirements for specific facilities outlined in *Volume 3, Chapters 4 and 5*, or Table F.1. Table F.14 is for general guidance and applicability only.

Table F.14. Applicability of Storm Types for Hydrologic Design Applications.

Storm Type	Description	Applicability	Total Storm Duration	Precipitation from SPU Rain Gauges
Short-duration	<ul style="list-style-type: none"> Typically occurs in late spring through early fall High intensity Limited volume 	<ul style="list-style-type: none"> Conveyance (storm drains, ditches, culverts, and other hydraulic structures) Flow Control 	3 hours	2 hours
Intermediate Duration	<ul style="list-style-type: none"> Typically occurs in fall through early winter Low intensity High volume 	<ul style="list-style-type: none"> Conveyance (storm drains, ditches, culverts, and other hydraulic structures) Flow Control 	18 hours	6 hours
Seattle 24-hour	NA	Volume Based BMPs	24 hours	24 hours
Long-duration – Front and Back Loaded	<ul style="list-style-type: none"> Typically occurs in late fall through early spring Low intensity High volume 	Flow Control	64 hours	24 hours

NA – not applicable

Short-Duration Storm (3-hour)

Short-duration design storms are used for design situations where peak discharge is of primary interest. The storm temporal pattern is shown in Figure F.12 as a dimensionless unit hyetograph. Tabular values for this hyetograph are listed in Attachment 1. The total storm precipitation is 1.06 times the 2-hour precipitation amount.

Use the following steps to utilize the short-duration storm in hydrologic analyses.

Step #	Procedure
SD-1	Obtain the 2-hour precipitation amount for the recurrence interval of interest (refer to Table 2 in Attachment 2). Note that the 2-hour precipitation values for short-duration storms do not vary across the City.
SD-2	Multiply the 5-minute incremental ordinates of the dimensionless short-duration design storm (Attachment 1, Table 1) by the 2-hour value from Step SD-1. Note that the resulting storm has a duration of 3 hours and the total storm amount will be 1.06 times the volume of the 2-hour precipitation (refer to the SDCI SPU Stormwater webpage for modeling resources).
SD-3	Input the resulting storm hyetograph into the hydrologic model. The resultant incremental precipitation ordinates have units of inches. To obtain the corresponding intensities (in/hr), multiply the precipitation increments by 12.

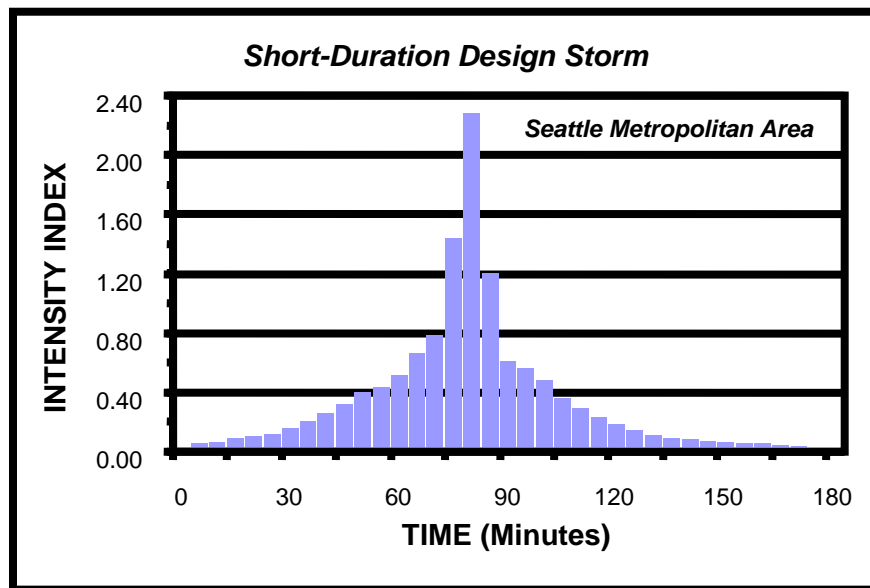

Figure F.12. Dimensionless Short-Duration (3-hour) Design Storm, Seattle Metropolitan Area.

Intermediate-Duration Storm (18 hour)

Intermediate-duration design storms are used in design applications where both peak discharge and runoff volume are important considerations and there is a need for a runoff hydrograph. The storm temporal pattern is shown in Figure F.13 as a dimensionless unit hyetograph. Tabular values for this hyetograph are listed in Attachment 1. The total storm precipitation is 1.51 times the 6-hour precipitation amount.

The following steps describe how to utilize the intermediate-duration storm in hydrologic analyses.

Step #	Procedure
ID-1	Obtain the 6-hour precipitation amount for the recurrence interval of interest for the watershed (refer to Attachment 2 for data from the SPU Gauge(s) of interest).
ID-2	Multiply the 10-minute incremental ordinates of the dimensionless intermediate-duration and long-duration design storms (Attachment 1, Tables 2 and 4) by the 6-hour value from Step ID-1. Note that the resulting storm has a duration of 18 hours and the total storm amount will be 1.51 times the volume of the 6-hour precipitation (refer to the SDCI SPU Stormwater webpage for modeling resources).
ID-3	Input the resulting storm hyetograph into the hydrologic model. The resultant incremental precipitation ordinates have units of inches. To obtain the corresponding intensities (in/hr), multiply the precipitation increments by 6.

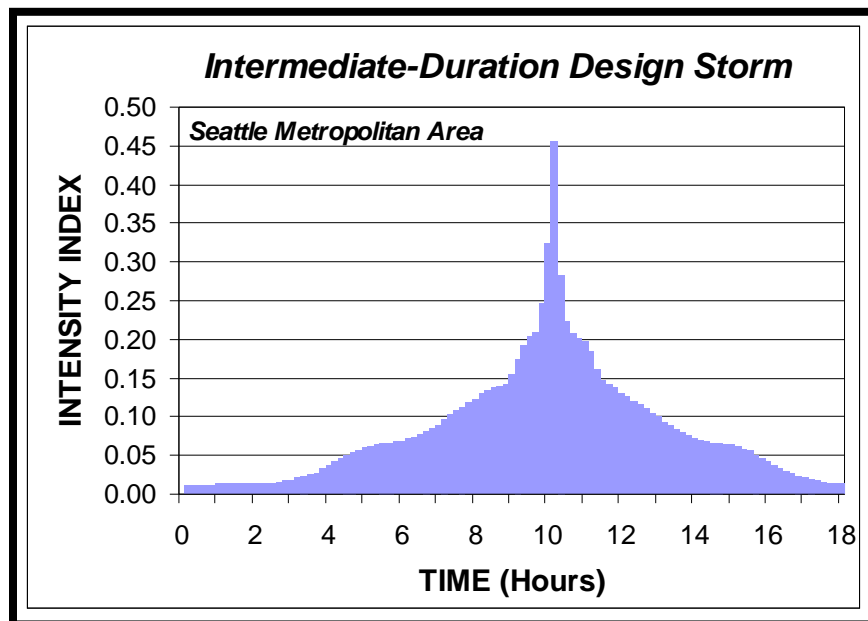

Figure F.13. Dimensionless Intermediate-Duration (18-hour) Design Storm, Seattle Metropolitan Area.

24-Hour Dimensionless Design Storm

Some specific volume-based stormwater facilities require or allow the use of a 24-hour design storm. To meet this need, the 24-hour dimensionless design storm was developed based on the maximum 24-hour period of precipitation within the long-duration design storm. It should be noted that the 24-hour dimensionless design storm has the same temporal shape and ordinates as the period of maximum 24-hour precipitation within the front-loaded and back-loaded long-duration dimensionless design storms. The City of Seattle 24-hour design storm is shown in Figure F.14.

Use the following steps to utilize the 24-hour design storm in hydrologic analyses:

Step #	Procedure
DD-1	Obtain the 24-hour precipitation amount for the recurrence interval of interest for the watershed (refer to Attachment 2 for data from the SPU Gauge(s) of interest).
DD-2	Multiply the 10-minute incremental ordinates of the dimensionless 24-hour duration design storm (Attachment 1, Table 5) by the 24-hour value from Step DD-1 (refer to the SDCI SPU Stormwater webpage for modeling resources).
DD-3	Input the resulting storm hyetograph into the hydrologic model. The resultant incremental precipitation ordinates have units of inches. To obtain the corresponding intensities (in/hr), multiply the precipitation increments by 6.

Long-Duration Storm (64 hour)

Long-duration design storms are primarily used in design of stormwater detention facilities and other projects where runoff volume is a primary consideration. Long-duration storms occur primarily in the late fall into early spring.

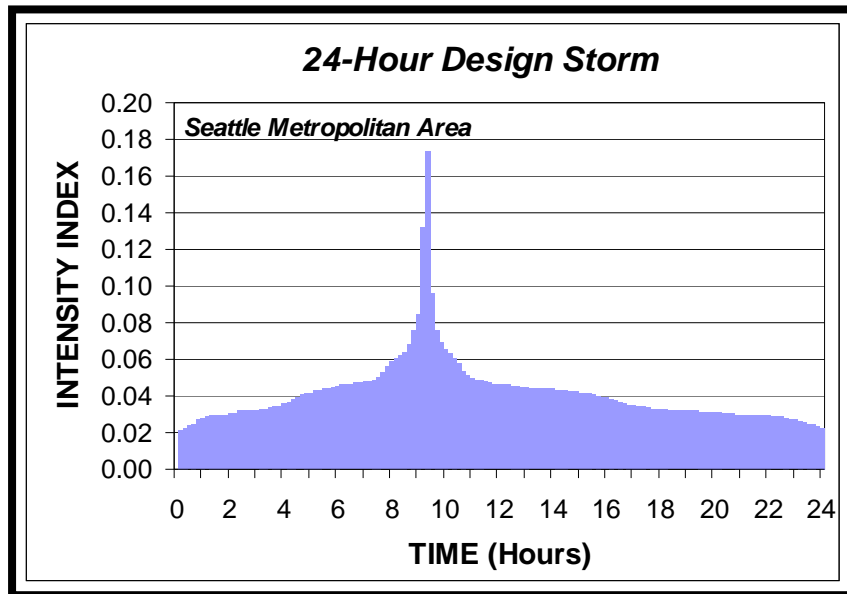

Figure F.14. Dimensionless 24-Hour Design Storm for Seattle Metropolitan Area.

Two long-duration dimensionless design storms are provided: a front-loaded design storm with the highest intensities at the beginning of the storm; and a back-loaded storm with the higher intensities nearer the end of the storm period. Characteristics of the front-loaded design storm have been observed more frequently, and this storm would be expected to produce more “typical” runoff conditions. The back-loaded storm occurs less often and is typically a more conservative event for drainage control facility design.

The long-duration storm hyetographs are 64 hours in duration. The storm temporal patterns for the front loaded and back loaded storms are shown in Figures F.15 and F.16 respectively. Tabular values for these storms are listed in Attachment 1. The total storm precipitation is

1.29 times the 24-hour precipitation amount for both the front and back loaded long-duration storm.

Use the following steps to utilize the long-duration storm in hydrologic analyses.

Step #	Procedure
LD-1	Obtain the 24-hour precipitation amount for the recurrence interval of interest for the watershed (refer to Attachment 2 for data from the SPU Gauge(s) of interest).
LD-2	Multiply the 10-minute incremental ordinates of the dimensionless long-duration design storm (Attachment 1, Table 3 or 4) by the 24-hour value from Step LD-1. Note that the resulting storm has a duration of 64 hours and the total storm amount will be 1.29 times the volume of the 6-hour precipitation (refer to the SDCI SPU Stormwater webpage for modeling resources).
LD-3	Input the resulting storm hyetograph into the hydrologic model. The resultant incremental precipitation ordinates have units of inches. To obtain the corresponding intensities (in/hr), multiply the precipitation increments by 6.

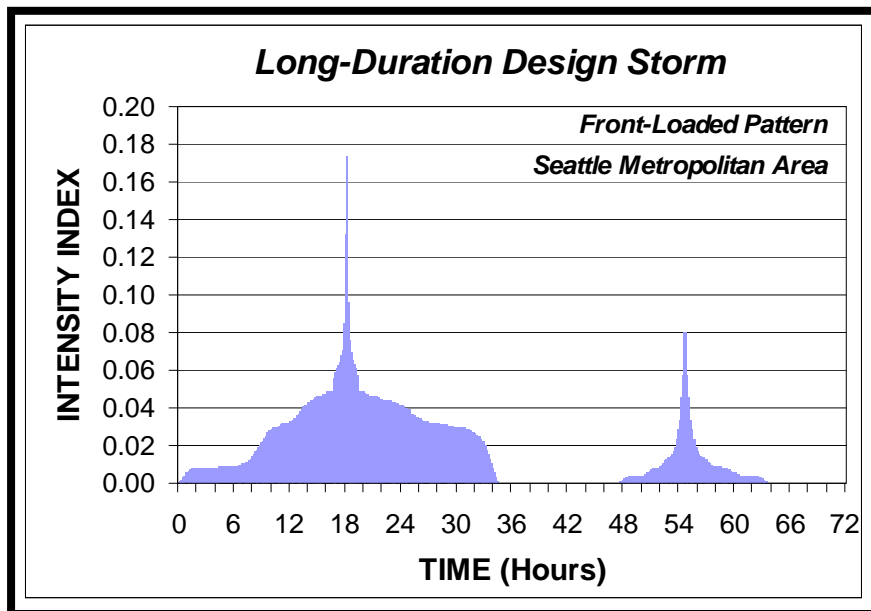

Figure F.15. Dimensionless Front-Loaded Long-Duration (64-hour) Design Storm for the Seattle Metropolitan Area.

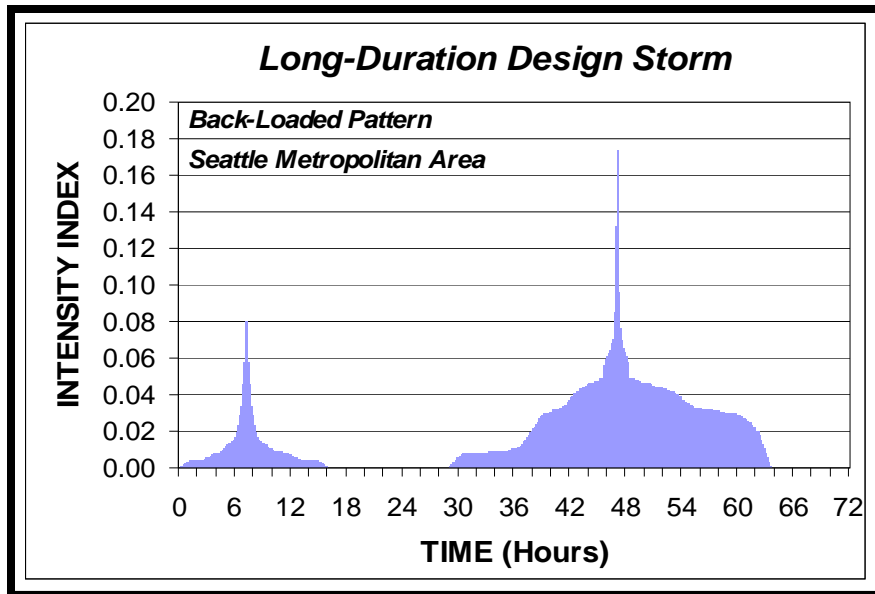

Figure F.16. Dimensionless Back-Loaded Long-Duration (64-hour) Design Storm for the Seattle Metropolitan Area.

Use of Historical Storms in Analysis

This section includes a catalog of the storms used to derive the design storm patterns described in the previous section. These historical storms can be used in rainfall runoff models to aid in the design process by replicating past floods. For example, an engineer could use the historical storms to demonstrate that a proposed conveyance system design would have adequate capacity to pass a large historical flood that occurred in the watershed. The storms could also be used for calibrating the hydrologic model to recorded flow data. Use of these historical storms to confirm a facility design is recommended but is not required for the design of stormwater facilities.

Tables F.15, F.16, and F.17 summarize historical storms recorded at City gauges for durations of 2 hours, 6 hours, and 24 hours respectively. Included in each table is the date when the storm ended, storm recurrence interval, and total precipitation for the duration of interest. The gauge locations are shown in Figure F.1. Electronic data for each storm is available in tabular form from SPU (refer to the SDCI SPU Stormwater webpage for modeling resources).

Table F.15. Catalog of Short Duration (2-hour) Storms at City Rain Gauges.

Station ID	Station Name	Storm End Date	Storm Recurrence Interval (years)	2-hour Precipitation (inches)
45-S002	Mathews Beach Pump Strn	06/14/1978	16	0.86
45-S003	UW Hydraulics Lab	11/03/1978	10	0.79
45-S009	Woodland Park Zoo	08/17/1980	20	0.89
45-S008	Ballard Locks	08/28/1980	20	0.89
45-S002	Mathews Beach Pump Strn	05/29/1985	7	0.74
45-S014	West Seattle High School	10/26/1986	15	0.85
45-S020	TT Minor Elementary	10/04/1990	18	0.88
45-S009	Woodland Park Zoo	08/09/1991	6	0.72
45-S008	Ballard Locks	09/23/1992	45	1.02
45-S003	UW Hydraulics Lab	11/23/1997	9	0.77
45-S011	Metro-KC Denny Regulating	02/17/1998	14	0.84
45-S016	Metro-KC E Marginal Way	07/15/2001	6	0.71
45-S012	Catherine Blaine Jr	08/23/2001	14	0.84
45-S020	TT Minor Elementary	05/28/2002	4	0.83
45-S009	Woodland Park Zoo	09/03/2002	10	0.79
45-S004	Maple Leaf Reservoir	10/20/2003	18	0.88
45-S003	UW Hydraulics Lab	12/14/2006	13	0.83

Table F.16. Catalog of Intermediate Duration (6-hour) Storms at City Rain Gauges.

Station ID	Station Name	Storm End Date	Storm Recurrence Interval (years)	6-hour Precipitation (inches)
45-S016	Metro-KC E Marginal Way	9/22/1978	32	1.61
45-S001	Haller Lake Shop	11/04/1978	70	1.74
45-S003	UW Hydraulics Lab	12/03/1982	92	1.82
45-S001	Haller Lake Shop	09/05/1984	5	1.21
45-S020	TT Minor Elementary	01/18/1986	>100	2.27
45-S010	Rainier Ave Elementary	01/09/1990	88	1.83
45-S003	UW Hydraulics Lab	12/29/1996	16	1.45
45-S004	Maple Leaf Reservoir	06/24/1999	7	1.28
45-S004	Maple Leaf Reservoir	10/20/2003	>100	1.96
45-S003	UW Hydraulics Lab	12/14/2006	36	1.62

Table F.17. ~~Catalog of Long Duration (24-hour) Storms at City Rain Gauges.~~

Station ID	Station Name	Storm End Date	Storm Recurrence Interval (years)	24-hour Precipitation (inches)
45-S008	Ballard Locks	12/17/1979	4	2.40
45-S009	Woodland Park Zoo	10/06/1981	24	3.07
45-S004	Maple Leaf Reservoir	11/01/1984	3	2.11
45-S001	Haller Lake Shop	01/18/1986	96	3.69
45-S016	Metro-KC E Marginal Way	11/23/1986	9	2.70
45-S003	UW Hydraulics Lab	11/24/1990	17	2.91
45-S002	Mathews Beach Pump Stn	04/04/1991	4	2.15
45-S020	TT Minor Elementary	02/08/1996	>100	5.07
45-S020	TT Minor Elementary	04/23/1996	8	2.56
45-S003	UW Hydraulics Lab	03/18/1997	7	2.53
45-S004	Maple Leaf Reservoir	11/25/1998	11	2.68
45-S010	Rainier Ave Elementary	11/14/2001	34	3.31
45-S004	Maple Leaf Reservoir	10/20/2003	>100	4.05

~~When using historical data from the City rain gauge network for model calibration, storms should be selected from stations as close as possible to the center of the watershed tributary to the project site. This will help ensure that the recorded data is representative of precipitation that fell in the watershed for storm of interest. In general, the shorter duration storms typically have smaller areal coverage and greater spatial variability than the longer duration storms. As a result, greater simulation errors would be expected if gauge data outside the watershed is used to simulate short duration storms.~~

SCS Curve Number Equation and Infiltration Parameters

The ~~SCS~~ Curve Number ~~loss~~ method may be used when computing runoff using the Long-duration storms (24 hours or 66 hours in length). The NRCS developed relationships between land use, soil type, vegetation cover, interception, infiltration, surface storage, and runoff. These relationships have been characterized by a single runoff coefficient called a “curve number” (CN). The National Engineering Handbook – Part 630: Hydrology (NRCS 1997) contains a detailed description of the development and use of the curve number method.

The CN is related to the runoff potential of a watershed according to equations (12) and (13).

$$Q_d = \frac{(P - 0.2 SMD_{MAX})^2}{(P + 0.8 SMD_{MAX})} \tag{12}$$

$$SMD_{MAX} = \frac{1000}{CN} - 10 \tag{13}$$

- Where:
- Q_d = runoff depth (inches)
 - P = precipitation depth (inches)
 - SMD_{MAX} = maximum soil moisture deficit (inches)
 - CN = ~~SCS~~ Curve Number for the soil (Table F. ~~1518~~)

The CN is a combination of a hydrologic soil group and land cover with higher CNs resulting in higher runoff. CN values for combinations of land cover and hydrologic soil group are listed in Table F.1548. Refer to Table F.3 in General Modeling Guidance (*Section F-3*) for information on soil groups in King County.

Table F.1548. SCS Western Washington Post-Development Runoff Curve Numbers for Selected Agricultural, Suburban, and Urban Areas.

Land Use Description		Curve Numbers by Hydrologic Soil Group			
		A	B	C	D
Land Cover Type and Hydrologic Condition					
<u>Pasture, grassland, or range-continuous forage for grazing</u>					
<u>Fair Condition (ground cover 50% to 75% and not heavily grazed)</u>		<u>49</u>	<u>69</u>	<u>79</u>	<u>84</u>
<u>Good Condition (ground cover >75% and lightly or only occasionally grazed)</u>		<u>39</u>	<u>61</u>	<u>74</u>	<u>80</u>
Cultivated land	Winter condition	86	94	94	95
Mountain-open areas	Low-growing brush and grasslands	74	82	89	92
Meadow or pasture		65	78	85	89
<u>Woods</u>					
<u>Fair Condition (woods are grazed but not burned, and some forest litter covers the soil)</u>		<u>36</u>	<u>60</u>	<u>73</u>	<u>79</u>
<u>Good Condition (woods are protected from grazing, and litter and brush adequately cover the soil)</u>		<u>30</u>	<u>55</u>	<u>70</u>	<u>77</u>
Wood or forest land	Undisturbed young second	42	64	76	84
Wood or forest land	growth or brush with cover	55	81	72	86
Orchard	crop	84	88	92	94
<u>Open spaces, (Llawns, parks, golf courses, cemeteries, landscaping, etc.)</u>					
<u>Fair Condition: (grass cover on 50 to 75% of the area)</u>		77	85	90	92
<u>Good Condition: (grass cover on greater than 75% of the area)</u>		68	80	86	90
<u>Impervious areas</u>					
<u>Open receiving waters: (lakes, wetlands, ponds, etc.)</u>		100	100	100	100
<u>Paved impervious surfaces: pavement, (roads, roofs, driveways, etc.)</u>		98	98	98	98
Gravel roads and parking lots		76	85	89	91
Dirt roads and parking lots		72	82	87	89
<u>Permeable pavement</u>					
<u>Porous asphalt, porous concrete, or grid/lattice systems (without underlying perforated drain pipes to collect stormwater)</u>		<u>77</u>	<u>85</u>	<u>90</u>	<u>92</u>
<u>Paving blocks (without underlying perforated drain pipes to collect stormwater)</u>		<u>87</u>	<u>91</u>	<u>94</u>	<u>96</u>
<u>All permeable pavement types (with underlying perforated drain pipes to collect stormwater)</u>		<u>98</u>	<u>98</u>	<u>98</u>	<u>98</u>

Time of Concentration Estimation

The time of concentration for the various surfaces and conveyances should be computed using the following methods, which are based on Chapter 3 of TR-55 (NRCS 1986).

Travel time (T_t) is the time it takes water to travel from one location to another in a watershed. T_t is a component of time of concentration (T_c), which is the time for runoff to travel from the hydraulically most distant point of the watershed. T_c is computed by summing all the travel times for consecutive components of the drainage conveyance system.

Water is assumed to move through a watershed as sheet flow, shallow concentrated flow, open channel flow, or some combination of these. The type that occurs is best determined by field inspection. The time of concentration (T_c) is the sum of T_t values for the various consecutive flow segments.

$$T_c = T_1 + T_2 + T_3 + \dots + T_n \quad (14)$$

Where: T_c = time of concentration (minutes)
 $T_{1,2,3,n}$ = time for consecutive flow path segments with different land cover categories or flow path slope

Travel time for each segment is computed using the following equation:

$$T_t = \frac{L}{60V} \quad (15)$$

Where: T_t = travel time (minutes)
 L = length of flow across a given segment (feet)
 V = average velocity across the land segment (ft/sec)

Sheet Flow: Sheet flow is flow over plane surfaces. Sheet flow travel time is computed using equation (16). This equation is applicable for relatively impervious areas with shallow flow depths up to about 0.1 foot and for travel lengths up to 300 feet. Modified Manning's effective roughness coefficients (n_s) are summarized in Table F. 1649. These n_s values are applicable for shallow flow depths up to about 0.1 foot and for travel lengths up to 300 feet.

$$T_t = 0.42 * (n_s * L)^{0.8} / ((P_{24})^{0.5} * (S_0)^{0.4}) \quad (16)$$

Where: T_t = travel time (minutes)
 n_s = sheet flow Manning's effective roughness coefficient from Table F. 1649
 L = overland flow length (feet)
 P_{24} = 2-year, 24-hour rainfall (inches)
 S_0 = slope of hydraulic grade line or land slope (feet/feet)

Shallow Concentrated Flow: After a maximum of 300 feet, sheet flow is assumed to become shallow concentrated flow. The average velocity for this flow can be calculated using the k_s values from Table F. 1649 in which average velocity is a function of watercourse slope and type of channel. After computing the average velocity using the velocity equation (17), the

travel time (T_t) for the shallow concentrated flow segment can be computed using the travel time equation (15).

Velocity Equation: A commonly used method of computing average velocity of flow, once it has measurable depth, is the following equation:

$$V = k_s \sqrt{S_o} \quad (17)$$

Where: k_s = velocity factor (Table F. [1649](#))
 S_o = slope of flow path (feet/feet)

"k" values in Table F. [1649](#) have been computed for various land covers and channel characteristics with assumptions made for hydraulic radius using the following rearrangement of Manning's equation:

$$k = (1.49 (R)^{0.667})/n \quad (18)$$

Where: R = assumed hydraulic radius
 n = Manning's roughness coefficient for open channel flow, from Tables F. [1649](#) or F. [1720](#)

Open Channel Flow: Open channels are assumed to begin where flow enters ditches or pipes, where surveyed cross section information has been obtained, where channels are visible on aerial photographs, or where lines indicating streams appear (in blue) on USGS quadrangle sheets. The k_c values from Table [F.166-14](#) used in velocity equation (17) or water surface profile information can be used to estimate average flow velocity. Average flow velocity is usually determined for bank-full conditions. The travel time (T_t) for the channel segment can be computed using travel time equation (15).

Lakes or Wetlands: Sometimes it is necessary to estimate the velocity of flow through a lake or wetland at the outlet of a watershed. This travel time is normally very small and can be assumed as zero. Where significant attenuation may occur due to storage effects, the flows should be routed using the "level-pool routing" technique described in the *Level-Pool Routing Method* section.

Limitations: The following limitations apply in estimating travel time (T_t):

- Manning's kinematic solution should not be used for sheet flow longer than 300 feet.
- In watersheds with drainage systems, carefully identify the appropriate hydraulic flow path to estimate T_c . Drainage systems generally handle only a small portion of a large event. The rest of the peak flow travels by streets, lawns, and other surfaces, to the outlet. Consult a standard hydraulics textbook (e.g., Gray 1961; Linsley et al. 1975; Pilgrim and Cordery 1993; Viessman et al. 1977) to determine average velocity in pipes for either pressure or non-pressure flow.
- A culvert or bridge can act as a reservoir outlet if there is significant storage behind it. A hydrograph should be developed to this point and the "level pool routing" technique should be used to determine the outflow rating curve through the culvert or bridge.

Table F. 1619. Values of “n” and “k” for use in Computing Time of Concentration.

FOR SHEET FLOW	n_s
Smooth surfaces (concrete, asphalt, gravel, or bare hard soil)	0.011
Fallow fields of loose soil surface (no vegetal residue)	0.05
Cultivated soil with crop residue (slope < 0.20 ft/ft)	0.06
Cultivated soil with crop residue (slope > 0.20 ft/ft)	0.17
Short prairie grass and lawns	0.15
Dense grass	0.24
Bermuda grass	0.41
Range, natural	0.13
Woods or forest, poor cover	0.40
Woods or forest, good cover	0.80
FOR SHALLOW, CONCENTRATED FLOW	k_s
Forest with heavy ground litter and meadows (n = 0.10)	3
Brushy ground with some trees (n = 0.06)	5
Fallow or minimum tillage cultivation (n = 0.04)	8
High grass (n = 0.035)	9
Short grass, pasture and lawns (n = 0.04)	11
Newly-bare ground (n = 0.025)	13
Paved and gravel areas (n = 0.012)	27
CHANNEL FLOW (INTERMITTENT, R = 0.2)	k_c
Forested swale with heavy ground litter (n = 0.10)	5
Forested drainage course/ravine with defined channel bed (n = 0.050)	10
Rock-lined waterway (n = 0.035)	15
Grassed waterway (n = 0.030)	17
Earth-lined waterway (n = 0.025)	20
CMP pipe (n = 0.024)	21
Concrete pipe (n = 0.012)	42
Other waterways and pipes	0.508/n
CHANNEL FLOW (CONTINUOUS STREAM, R = 0.4)	k_c
Meandering stream with some pools (n = 0.040)	20
Rock-lined stream (n = 0.035)	23
Grassed stream (n = 0.030)	27
Other streams, man-made channels and pipe	0.807/n

Source: USDA (1986).

Table F.1720. Other Values of the Roughness Coefficient “n” for Channel Flow.

Type of Channel and Description	Manning’s “n”	Type of Channel and Description	Manning’s “n”
A. Constructed Channels		6. Sluggish reaches, weedy deep pools	0.070
a. Earth, straight and uniform		7. Very weedy reaches, deep pools, or floodways with heavy stands of timber and underbrush	0.100
1. Clean, recently completed	0.018		
2. Gravel, uniform selection, clean	0.025	b. Mountain streams, no vegetation in channel, banks usually steep, trees and brush along banks submerged at high stages	
3. With short grass, few weeds	0.027	1. Bottom: gravel, cobbles, and few boulders	0.040
b. Earth, winding and sluggish		2. Bottom: cobbles with large boulders	0.050
1. No vegetation	0.025	B-2 Flood plains	
2. Grass, some weeds	0.030	a. Pasture, no brush	
3. Dense weeds or aquatic plants in deep channels	0.035	1. Short grass	0.030
4. Earth bottom and rubble sides	0.030	2. High grass	0.035
5. Stony bottom and weedy banks	0.035	b. Cultivated areas	
6. Cobble bottom and clean sides	0.040	1. No crop	0.030
c. Rock lined		2. Mature row crops	0.035
1. Smooth and uniform	0.035	3. Mature field crops	0.040
2. Jagged and irregular	0.040	c. Brush	
d. Channels not maintained, weeds and brush uncut		1. Scattered brush, heavy weeds	0.050
1. Dense weeds, high as flow depth	0.080	2. Light brush and trees	0.060
2. Clean bottom, brush on sides	0.050	3. Medium to dense brush	0.070
3. Same, highest stage of flow	0.070	4. Heavy, dense brush	0.100
4. Dense brush, high stage	0.100	d. Trees	
B. Natural Streams		1. Dense willows, straight	0.150
B-1 Minor streams (top width at flood stage <100 ft.)		2. Cleared land with tree stumps, no sprouts	0.040
a. Streams on plain		3. Same as above, but with heavy growth of sprouts	0.060
1. Clean, straight, full stage no rifts or deep pools	0.030	4. Heavy stand of timber, a Few down trees, little undergrowth, flood stage below branches	0.100
2. Same as above, but more stones and weeds	0.035	5. Same as above, but with flood stage reaching branches	0.120
3. Clean, winding, some pools and shoals	0.040		
4. Same as above, but some weeds	0.040		
5. Same as 4, but more stones	0.050		

Single-Event Routing Methods Overview

In the United States, the majority of single-event models for computation of runoff hydrographs are based on unit hydrographs. Most commercial software packages utilize unit hydrographs for making the transformation from computation of runoff volume to generation of the runoff hydrograph. This may require direct input of the ordinates of the unit hydrograph or the unit hydrograph may be computed internally based on watershed characteristics provided by the user. Notable exceptions include event-based models that utilize linear reservoir concepts, such as the Santa Barbara Urban Hydrograph model (SBUH), event-based models that utilize kinematic wave approaches, and continuous flow simulation models such as HSPF.

The *Unit Hydrograph Routing Methods* section describes rainfall-runoff modeling based on unit hydrograph concepts. The reader is referred to any standard hydrology textbook (e.g., Gray 1961; Linsley et al. 1975; Pilgrim and Cordery 1993; Viessman et al. 1977) for a detailed discussion of unit hydrograph theory. The *SBUH Routing Method* section includes a discussion of runoff hydrographs developed using the SBUH model. The *Level-Pool Routing Method* section provides a discussion on the level-pool method, which is appropriate for routing hydrographs through lakes, wetlands, and other areas of standing water.

Unit Hydrograph Routing Methods

The unit hydrograph is defined as the time-distribution of runoff (Figure F.17) measured at the watershed outlet as produced by 1 inch of runoff uniformly generated over the watershed during a specified period of time. Thus, a 10-minute unit hydrograph would be the runoff hydrograph (cfs) observed at the watershed outlet as generated by 1 inch of runoff uniformly produced over the watershed in a 10-minute period.

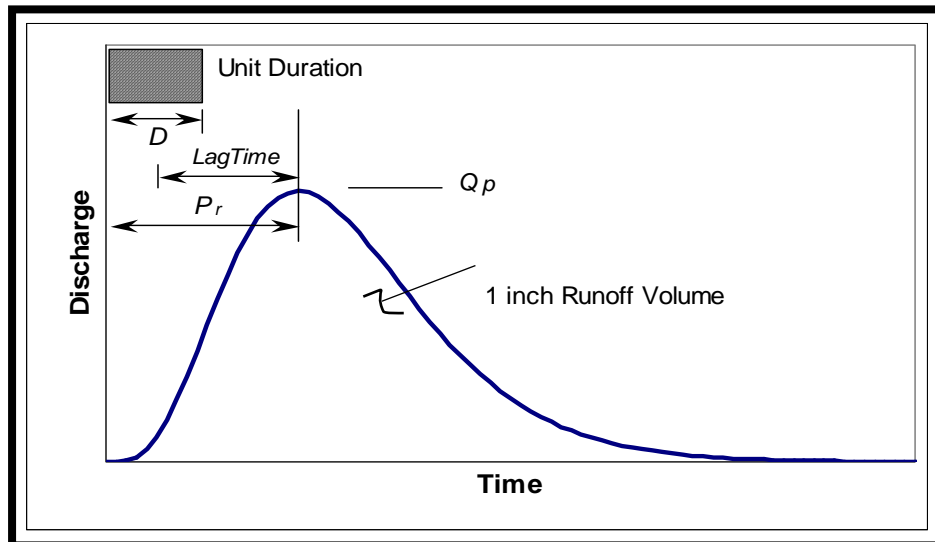

Figure F.17. Characteristics of Unit Hydrographs.

In computation of the runoff hydrograph, the unit hydrograph is scaled by the runoff in each D-minute period, and the resultant hydrographs for each D-minute period are added by superposition to yield the runoff hydrograph from the watershed.

Relationship of Computational Time Step to Time Lag (Lag Time). As indicated above, the ordinates of the unit hydrograph are specified on intervals equal to the computational time step. Recognizing that the time step and unit duration are equal ($\Delta t = D$), the unit duration must be chosen small enough to allow reasonable definition of the rising limb of the unit hydrograph. This is required to provide for adequate definition of the resultant runoff hydrograph in the vicinity of the runoff peak discharge. In addition, the value of D should be an integer multiple of the period of rise P_r so that the computational time step (Δt) falls on the peak discharge of the unit hydrograph.

Selection of Time Step (Δt) Based on Time of Concentration (T_c). The time-of concentration of the watershed (T_c) is often taken to be the elapsed time from the end of the unit duration (D) to the inflection point on the recession limb of the unit hydrograph (NRCS 1997). When the runoff hydrograph is computed based on unit hydrograph concepts utilizing time of concentration, the computational time step should be:

$$\Delta t < T_c/5 \quad (19)$$

To enhance compatibility with the City of Seattle design storms, the computational time step for runoff computations should be a multiple of the time step used to describe the design storm. The short-duration design storm is described in 5-minute intervals and the intermediate and long-duration design storms are described in 10-minute intervals. Therefore, the following additional criteria are required for selection of the time step for use with the short-duration design storm:

$$\Delta t = 5/n \quad (20)$$

And, for use with the intermediate and long-duration design storms:

$$\Delta t = 10/n \quad (21)$$

Where: n = integer greater than or equal to one

The above information should be particularly helpful for use with computer software that allows output of the runoff hydrograph on a time interval other than that used for internal computation of the runoff hydrograph. For those cases, the user may be unaware of the unit duration (D) and internal time step (Δt) being used by the computer program.

SBUH Routing Method

The SBUH method is an adaptation of standard hydrologic routing methods that employ the principle of conservation of mass. The routing equation for the SBUH method may be derived from linear reservoir concepts (Linsley et al. 1975; Fread 1993) where storage is taken to be a linear function of discharge.

The SBUH method uses two steps to synthesize the runoff hydrograph:

Step 1 – Compute the instantaneous hydrograph

Step 2 – Compute the runoff hydrograph

The instantaneous hydrograph is computed as follows:

$$I(t) = 60.5 R(t) A/\Delta t \quad (22)$$

Where: $I(t)$ = instantaneous hydrograph at each time step (Δt) (cfs)
 $R(t)$ = total runoff depth (both impervious and pervious) at time increment
 Δt (inches)
 A = area (acres)
 Δt = computational time step (minutes)

The runoff hydrograph is then obtained by routing the instantaneous hydrograph through an imaginary reservoir with a time delay equal to the time of concentration of the drainage basin. The following equation estimates the routed flow:

$$Q(t+1) = Q(t) + w[I(t) + I(t+1) - 2Q(t)] \quad (23)$$

$$w = \Delta t / (2T_c + \Delta t) \quad (24)$$

Where: $Q(t)$ = runoff hydrograph or routed flow (cfs)
 T_c = time of concentration (minutes)
 Δt = computational time step (minutes)

Selection of Time Step (Δt) Based on Time of Concentration (T_c). Equation (23) requires that the computational time step be sufficiently short that the change in inflow, outflow, and storage during the time step can be treated as linear. For the case of very small urban watersheds, the low to moderate intensities in the long-duration design storm would typically generate runoff over a longer period than the time of concentration of the watershed. As a result, the elapsed time of the rising limb of the runoff hydrograph (T_r) would likewise be much longer than the time of concentration of the watershed. In addition, the computational time step for routing should be a multiple of the time step used to describe the design storm. Therefore, for intermediate and long-duration storms, the computational time step should satisfy equations (25) and (26):

$$\Delta t < T_c \quad (25)$$

$$\Delta t = 10/n \quad (26)$$

Where: Δt = computational time step (minutes)
 T_c = time of concentration (minutes)
 n = an integer greater than or equal to one

For short duration design storms, the flood peak of the runoff hydrograph may be quite flashy and produced by high-intensity precipitation during a limited portion of the storm. For this case, the elapsed time for the rising limb of the runoff hydrograph may be similar in magnitude to that of the time-of-concentration of the watershed. In this situation, the time step should be smaller than the time of concentration. In addition, the computational time step for routing should be a multiple of the time step used to describe the design storm. Therefore, for the short-duration storm, the computational time step should satisfy equations (27) and (28):

$$\Delta t < T_c/5 \quad (27)$$

$$\Delta t = 5/n \quad (28)$$

Where: Δt = computational time step (minutes)
 T_c = time of concentration (minutes)
 n = an integer greater than or equal to one

Level-Pool Routing Method

This section presents a general description of the methodology for routing a hydrograph through a retention/detention facility, closed depression, or wetland. Note that the City does not allow the use of single-event models for retention/detention facility design. The information presented in this section is for informational purposes only. The level pool routing technique (Fread 1993) is based on the continuity equation:

Inflow-outflow=change in storage

$$\left[\frac{I_1 + I_2}{2} - \frac{O_1 + O_2}{2} \right] = \frac{\Delta S}{\Delta t} = S_2 - S_1 \quad (29)$$

rearranging:

$$I_1 + I_2 + 2S_1 - O_1 = O_2 + 2S_2 \quad (30)$$

Where: I = inflow at time 1 and time 2
 O = outflow at time 1 and time 2
 S = storage at time 1 and time 2
 Δt = computational time step (minutes)

The time step (Δt) must be consistent with the time interval used in developing the inflow hydrograph.

The following summarizes the steps required in performing level-pool hydrograph routing:

- Develop stage-storage-discharge relationship, which is a function of pond/wetland geometry and outflow
- Route the inflow hydrograph through the structure by applying equation (30) at each time step, where the inflow hydrograph supplies values of I , the stage-storage relationship supplies values of S , and the stage discharge relationship provides values of O .

Commercially available hydrologic computer models perform these calculations automatically.

Modeling Guidance

The following sections present the general process involved in conducting a hydrologic analysis using single-event hydrograph methods to evaluate or design stormwater conveyance systems. Applicability of single-event methods and design standard requirements are discussed in *Section F-2 of this appendix*.

Steps for Hydrologic Design Using Single-Event Methods

The following summarizes the process for conducting hydrologic analyses using single-event models.

Step #	Procedure
SE-1	Review all minimum requirements that apply to the proposed project (<i>Volume 1</i>)
SE-2	Review applicable site definition and mapping requirements (<i>Volume 1</i>)
SE-3	Identify and delineate the overall drainage basin for each discharge point from the development site under existing conditions: <ul style="list-style-type: none"> ● Identify existing land use ● Identify existing soil types using on-site evaluation, NRCS soil survey, or mapping performed by the University of Washington (http://geomapnw.ess.washington.edu) ● Identify existing drainage features such as streams, conveyance systems, detention facilities, ponding areas, depressions, etc.
SE-4	Select and delineate pertinent subbasins based on existing conditions: <ul style="list-style-type: none"> ● Select homogeneous subbasin areas ● Select separate subbasin areas for on-site and off-site drainage ● Select separate subbasin areas for major drainage features.

Stormwater Conveyance

Existing and proposed stormwater conveyance facilities may be analyzed and designed using peak flows from hydrographs derived from single-event approaches described in this appendix. In addition to the steps listed in the *Steps for Hydrologic Design Using Single-event Methods* section, the following steps should be followed for designing/analyzing conveyance facilities:

Step #	Procedure
SC-1	Determine runoff parameters for each subbasin
SC-2	Identify pervious and impervious areas <ul style="list-style-type: none"> ● The short- or intermediate-duration design storm generally governs the design of conveyance facilities. Both storm durations should be treated as candidate design storms and the one that produces the more conservative design (higher peak discharge rates) used as the design storm (refer to Design Storm Hyetograph section). ● Select runoff parameters per the Infiltration Equation section. ● Compute time of concentration per the Time of Concentration Estimation section.
SC-3	Identify downstream hydraulic controls, such as outfalls (refer to Outfalls in <i>Section F-3</i>), known flooding locations, receiving pipe HGL, pump station, regulator station, weirs or orifice. Determine if backwater calculations or a dynamic hydraulic routing model are required.

Step #	Procedure
SC-4	Compute runoff for the drainage system and determine peak discharge at the outlet of each subbasin for the design storm of interest
SC-5	Perform a capacity analysis to verify that there is sufficient capacity in the public drainage system or the public combined sewer system. Refer to <i>Volume 3, Section 4.3</i> and SMC, Section 22.805.020.J for specific requirements.
SC-6	Size the pipe based on the designated level of service.

F-6. Rational Method

The rational method is based on the assumption that rainfall intensity for any given duration is uniform over the entire tributary watershed. The rational formula relates peak discharge from the site of interest to rainfall intensity times a coefficient:

$$Q = CiA \quad (31)$$

Where:

- Q = peak discharge from the site of interest
- C = dimensionless runoff coefficient
- i = rainfall intensity for a given recurrence interval (in/hr)
- A = tributary area (acres)

The rainfall intensity (i) is determined from Figure F.18 or Table F.1821 for the precipitation recurrence interval of interest and duration corresponding to the calculated time of concentration (refer to *Time of Concentration Estimation* section below).

Peak Rainfall Intensity Duration Frequency (IDF curves)

Rainfall intensity-duration-frequency (IDF) curves allow calculation of average design rainfall intensity for a given exceedance probability (recurrence interval) over a range of durations. Precipitation-frequency statistics presented in this appendix were analyzed using data from the City's 17-gauge precipitation measurement network within the City of Seattle, and the national NOAA cooperative gauge network 13. Durations of 5 minutes, 10 minutes, 15 minutes, 20 minutes, 30 minutes, 45 minutes, 60 minutes, 2 hours, 3 hours, 6 hours, 12 hours, 24 hours, 48 hours, 72 hours, and 7 days were analyzed to develop the IDF curves. IDF curves for storm durations up to 3 hours and applicable to sites within Seattle are shown in Figure F.21.

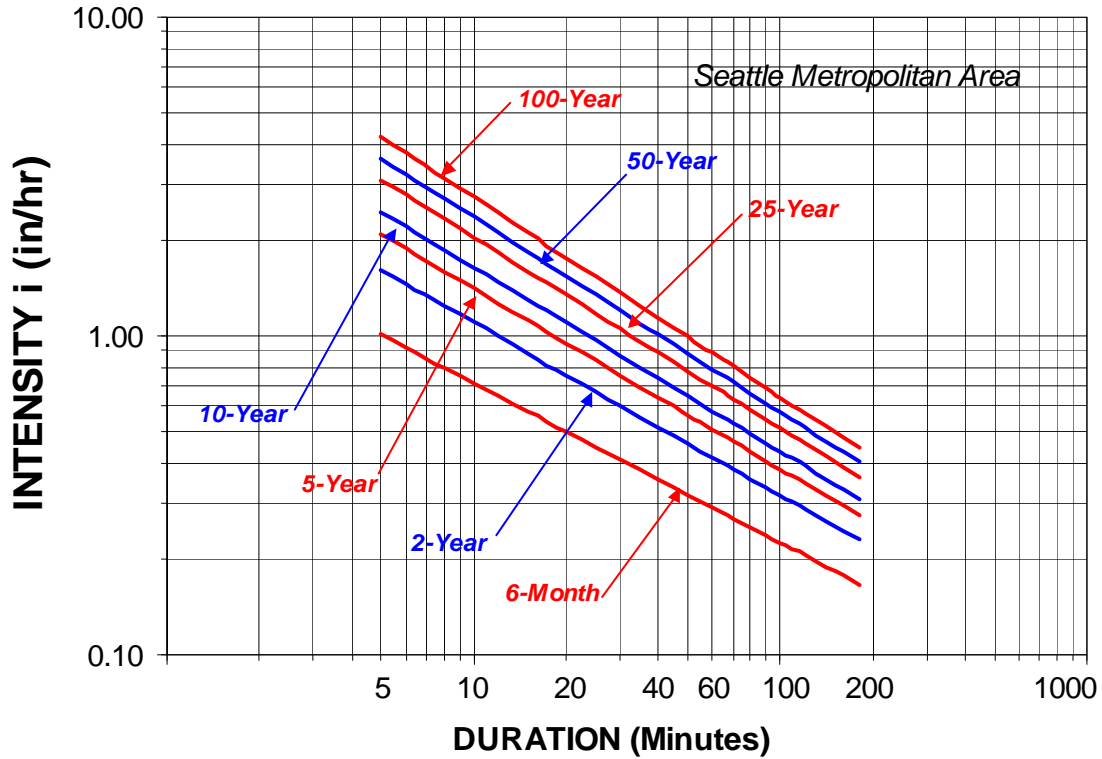

Figure F.18. Intensity-Duration-Frequency Curves for the City of Seattle.

Table F.1824. Intensity-Duration-Frequency Values for 5- to 180-Minute Durations for Selected Recurrence Intervals for the City of Seattle.

Duration (minutes)	Precipitation Intensities (in/hr)							
	Recurrence Interval (years)							
	6-mo	2-yr	5-yr	10-yr	20-yr	25-yr	50-yr	100-yr
5	1.01	1.60	2.08	2.45	2.92	3.08	3.61	4.20
6	0.92	1.45	1.87	2.21	2.62	2.76	3.23	3.75
8	0.80	1.24	1.59	1.87	2.21	2.32	2.71	3.13
10	0.71	1.10	1.40	1.64	1.93	2.03	2.36	2.72
12	0.65	1.00	1.27	1.48	1.74	1.82	2.11	2.43
15	0.58	0.88	1.12	1.30	1.52	1.60	1.84	2.11
20	0.50	0.75	0.95	1.10	1.28	1.34	1.54	1.76
25	0.45	0.67	0.84	0.97	1.12	1.18	1.35	1.53
30	0.41	0.61	0.76	0.87	1.01	1.05	1.21	1.37
35	0.38	0.56	0.69	0.80	0.92	0.96	1.10	1.24
40	0.35	0.52	0.64	0.74	0.85	0.89	1.01	1.14
45	0.33	0.49	0.60	0.69	0.79	0.83	0.94	1.06
50	0.32	0.46	0.57	0.65	0.74	0.78	0.88	0.99
55	0.30	0.44	0.54	0.61	0.70	0.73	0.83	0.94
60	0.29	0.42	0.51	0.58	0.67	0.70	0.79	0.89
65	0.28	0.40	0.49	0.56	0.64	0.66	0.75	0.84

Table F.1824 (continued). Intensity-Duration-Frequency Values for 5- to 180-minute Durations for Selected Recurrence Intervals for the City of Seattle.

Duration (minutes)	Precipitation Intensities (in/hr)							
	Recurrence Interval (years)							
	6-mo	2-yr	5-yr	10-yr	20-yr	25-yr	50-yr	100-yr
70	0.27	0.38	0.47	0.53	0.61	0.64	0.72	0.80
80	0.25	0.36	0.43	0.49	0.56	0.59	0.66	0.74
90	0.24	0.33	0.41	0.46	0.52	0.55	0.62	0.69
100	0.22	0.32	0.38	0.43	0.49	0.51	0.58	0.64
120	0.20	0.29	0.35	0.39	0.44	0.46	0.52	0.57
140	0.19	0.26	0.32	0.36	0.40	0.42	0.47	0.52
160	0.18	0.24	0.29	0.33	0.37	0.39	0.43	0.48
180	0.17	0.23	0.27	0.31	0.35	0.36	0.40	0.45

Runoff Coefficients

Runoff coefficients vary with the tributary land cover and to a certain extent, the total depth and intensity of the rainfall. The storm depth and intensity is typically neglected, and the runoff coefficient is based on land cover only (Table F.1922). For watersheds containing several land cover types, an aggregate runoff coefficient can be developed by computing the area weighted average from all cover types present (equation 32):

$$C_c = (C_1A_1 + C_2A_2 + C_3A_3 + \dots + C_nA_n) / A_t \quad (32)$$

Where: C_c = composite runoff coefficient for the site
 $C_{1, 2, \dots, n}$ = runoff coefficient for each land cover type
 $A_{1, 2, \dots, n}$ = area of each land cover type (acres)
 A_t = total tributary area (acres)

Table F.1922. Rational Equation Runoff Coefficients.

Land Cover	Runoff Coefficient (C)
Dense Forest	0.10
Light Forest	0.15
Pasture	0.20
Lawns	0.25
Gravel Areas	0.80
Pavement and Roofs	0.90
Open Water (Ponds Lakes and Wetlands)	1.00

Time of Concentration Estimation

Time of concentration (T_c) is defined as the time it takes for runoff to travel from the most hydraulically distant point of the drainage area to the outlet. T_c is computed by summing all the travel times for consecutive components of the drainage conveyance system.

$$T_c = T_1 + T_2 + T_3 + \dots + T_n \quad (33)$$

Where: T_c = time of concentration (minutes)
 $T_{1,2,3,\dots,n}$ = time for consecutive flow path segments with different land cover categories or flow path slope

Travel time for each segment is computed using the following equation:

$$T_t = L / V$$

Where: T_t = travel time (minutes)
 L = length of flow across a given segment (feet)
 V = average velocity across the land segment (ft/sec)

$$V = k_r \sqrt{S_o} \quad (34)$$

Where: k_r = Velocity factor (Table F.2023)
 S_o = Slope of flow path (feet/feet)

Table F.2023. Coefficients for Average Velocity Equation.

Land Cover	Velocity Factor (k_r)
Forest with Heavy Ground Cover and Meadow	2.5
Grass, Pasture, and Lawns	7.0
Nearly Bare Ground	10.1
Grassed Swale or Channel	15.0
Paved Areas	20.0

F-7. Risk-Based Hydrologic Design Concepts

Risk-based concepts and analytical approaches are being used more frequently in hydrologic design. A risk-based approach focuses on evaluating the two components of risk: the probability, and consequences of failure. Failure may be broadly defined and includes failure to meet a project goal, failure to meet a regulatory requirement, or the physical failure of a project element. Consequences of failure vary with the project type and features and may include economic, life safety, environmental, and political consequences.

Risk can be described qualitatively or quantitatively. For example, qualitative risk is often expressed as low, moderate, high, or very high, based on various combinations of the probability of failure and the consequences of failure. Quantitative risk assessment requires more detailed analysis to provide numerical measures of the probability of failure and consequences of failure. Quantitative units of measure for risk include loss of life per year for

life safety risk, and dollars per year for consequences that can be expressed in economic terms.

Risk concepts are often used in design where the design target, level-of-service, etc., is based on the consequences of failure or upon some adopted level of qualitative or quantitative risk. The design targets and level of conservatism of design are typically set based on the tolerable level of risk for a given project type or consideration of the regulatory requirements.

When applying a risk-based approach, engineers and hydrologists primarily evaluate the probability of failure (or probability of being in compliance) and may assess how and which uncertainties affect the probability of failure (or probability of being in compliance). Application of hydrologic computer models and detailed numerical descriptions of hydrologic/hydraulic system components are an integral part of assessing the probability of being in compliance.

Uncertainty

Historically, uncertainty in hydrologic simulation analyses and the consequences for analysis results are rarely quantified as part of stormwater engineering design. Factors of safety have typically been applied at the end of a hydrologic analysis to account for uncertainties in the analysis. The same factor of safety is typically used regardless of the level of uncertainty or the confidence in the hydrologic model's ability to realistically simulate runoff. For many projects, the fixed safety factor approach is adequate. However, for projects where the consequences of failure (an erroneous design) are large, quantifying the analysis uncertainty and risk of not meeting the design standard may be beneficial in selecting an appropriate level of design conservatism.

F-8. References

- Chow, V.T., D.R. Maidment, and L.W. Mays. 1988. Applied Hydrology. McGraw-Hill, Inc. pp. 140-147.
- Dinicola, R.S. 1990. Characterization and Simulation of Rainfall Runoff Relations in Western King and Snohomish Counties, Washington. US Geological Survey, Water-Resources Investigations Report 89-4052.
- Dinicola, R.S. 2001. Validation of a numerical modeling method for simulating rainfall-runoff relations for headwater basins in western King and Snohomish counties, Washington. Water Supply Paper 2495.
- Dunin, F.X. 1976. Infiltration: Its Simulation for Field Conditions. Chapter 8 in: Facets of Hydrology. J.C. Rodda (ed.). John Wiley & Sons, New York, NY. pp. 199-227.
- Fread, D.L. 1993. Flow Routing. Chapter 10 in: Handbook of Hydrology. D.R. Maidment (ed.). McGraw-Hill, Inc.

- Gray, D.M. 1961. Synthetic Unit-Hydrographs for Small Drainage Areas. Proceedings ASCE, Journal Hydraulics Division, 87, No. 4, HY4, July 1961.
- Gringorten, I.I. 1963. A Plotting Rule for Extreme Probability Paper. Journal of Geophysical Research, vol. 68, pp. 813-814.
- Holtan, H.N. 1961. A Concept for Infiltration Estimates in Watershed Engineering. US Dept. of Agriculture. ARS 41-51.
- Holtan, H.N., Stiltner, G.I., Hensen, W.H., and N.C. Lopez. 1975. USDA HL-74 Revised Model of Watershed Hydrology. U. S. Department of Agriculture, Tech. Bull. 1518. 99 pp.
- Horton, R.E. 1940. An Approach Towards a Physical Interpretation of Infiltration Capacity. Soil Science Society of America Proceedings 5:399-417.
- Interagency Advisory Committee on Water Data. 1981. Guidelines for Determining Flood flow Frequency. Bulletin #17b. September 1981.
- King County. 2009. King County, Washington Surface Water Design Manual. Prepared by the King County Department of Natural Resources and Parks. January 9, 2009.
- King County Surface Water Management Division. 1999. King County Runoff Time series (KCRTS). Computer Software Reference Manual, Version 4.4.
- King County. ~~2015~~~~2014~~~~b~~. Major Lakes Monitoring. Available online at <https://green2.kingcounty.gov/lakes>~~http://green.kingcounty.gov/lakes~~.
- King County. ~~2016~~~~2014~~~~a~~. Small Lakes ~~Data and Information and Data~~. Available online at <https://green2.kingcounty.gov/smalllakes/Default.aspx>~~http://your.kingcounty.gov/dnrr/wlr/water-resources/small-lakes/data/default.aspx~~.
- Kostiakov, A.N. 1932. On the Dynamics of the Coefficient of Water Percolation in Soils and on the Necessity of Studying it from a Dynamic Point of View for the Purposes of Amelioration. Trans. Com. Int. Soc. Soil Sci. 6th Moscow A: 17-21.
- Linsley, R.K., M.A. Kohler, and J.L.H. Paulhus. 1975. Hydrology for Engineers. Second Edition. McGraw-Hill, Inc.
- [Miller, I.M., H. Morgan, G. Mauger, T. Newton, R. Weldon, D. Schmidt, M. Welch, E. Grossman. 2018. Projected Sea Level Rise for Washington State – A 2018 Assessment. A collaboration of Washington Sea Grant, University of Washington Climate Impacts Group, University of Oregon, University of Washington, and US Geological Survey. Prepared for the Washington Coastal Resilience Project.](#)
- Musgrave, G.W. 1995. How Much of the Rain Enters the Soil? In USDA Water Yearbook of Agriculture, Washington, D.C. pp 151-159.
- NOAA. 1995. Tide Predictions Program (NTP4) Users Manual. Prepared by the National Oceanic and Atmospheric Administration.

- NRC. 2012. Sea-Level Rise for the Coasts of California, Oregon, and Washington: Past, Present, and Future. Prepared by the Committee on Sea Level Rise in California, Oregon, and Washington. National Research Council of the National Academies.
- NRCS. 1986. Urban Hydrology for Small Watersheds TR-55. Prepared by the United States Department of Agriculture Natural Resources Conservation Service, Conservation Engineering Division. June 1986.
- NRCS. 1997. National Engineering Handbook, Part 630-Hydrology, September 1997. Natural Resources Conservation Service. Available online at <<http://www.nrcs.usda.gov/wps/portal/nrcs/detailfull/national/water/?cid=stelprdb1043063>>.
- Parlange, J.-Y., and R. Haverkamp. 1989. Infiltration and Ponding Time. In: Unsaturated Flow in Hydrologic Modeling, Theory and Practice. H.J. Morel-Seytoux (ed.). Pp. 95-126. Kluwer Academic Publishers, Boston, MA.
- Philip, J.R. 1957a. The theory of infiltration. 1. The infiltration equation and its solution. Soil Science 83:345-357.
- Philip, J.R. 1957b. Numerical solutions of equations of the diffusivity type with diffusivity concentration dependent. II. Australian J. Phys. 10:29-42.
- Pilgrim, D.H., and I. Cordery. 1993. Flood Runoff. Chapter 9 in: Handbook of Hydrology. D.R. Maidment (ed.). McGraw-Hill, Inc.
- Rawls, Walter, et al. 1993. Infiltration and Soil Water Movement. Chapter 5 in: Handbook of Hydrology. D.R. Maidment (ed.). McGraw-Hill, Inc.
- Schaefer, M.G., and B.L. Barker. 2002. Extended Precipitation Time-Series for Continuous Hydrological Modeling in Western Washington. Prepared for Washington State Department of Transportation by MGS Engineering Consultants Inc. April 2002.
- Schaefer, M.G. 2004. Analyses of Precipitation-Frequency and Storm Characteristics for the City of Seattle. Prepared for Seattle Public Utilities by MGS Engineering Consultants Inc. March 2004.
- Schaefer M.G. and B.L. Barker. 2007. Development of 5-Minute Extended Precipitation Time-Series for the City of Seattle. Prepared for Seattle Public Utilities by MGS Engineering Consultants Inc. January 2007.
- USDA, Natural Resources Conservation Service, Urban Hydrology for Small Watersheds, TR-55, Technical Release 55, June 1986.
- US Environmental Protection Agency. 2001. Hydrological Simulation Program-Fortran. Release 12. EPA Contract No. 68-C-98-010. March 2001.
- Viessman, W., J.E. Knapp, G.L. Lewis, and T.E. Harbaugh. 1977. Introduction to Hydrology. Second Edition. Harper and Row.

Attachment 1

Design Storm Dimensionless Hyetograph Ordinates

ATTACHMENT 1 – DESIGN STORM DIMENSIONLESS HYETOGRAPH ORDINATES

Table 1. Dimensionless Ordinates of the Short-Duration Design Storm.

DIMENSIONLESS ORDINATES OF SHORT-DURATION DESIGN STORM		
ELAPSED TIME (min)	INCREMENTAL ORDINATES	CUMULATIVE ORDINATES
0	0.0000	0.0000
5	0.0045	0.0045
10	0.0055	0.0100
15	0.0075	0.0175
20	0.0086	0.0261
25	0.0102	0.0363
30	0.0134	0.0497
35	0.0173	0.0670
40	0.0219	0.0889
45	0.0272	0.1161
50	0.0331	0.1492
55	0.0364	0.1856
60	0.0434	0.2290
65	0.0553	0.2843
70	0.0659	0.3502
75	0.1200	0.4702
80	0.1900	0.6602
85	0.1000	0.7602
90	0.0512	0.8114
95	0.0472	0.8586
100	0.0398	0.8984
105	0.0301	0.9285
110	0.0244	0.9529
115	0.0195	0.9724
120	0.0153	0.9877
125	0.0125	1.0002
130	0.0096	1.0098
135	0.0077	1.0175
140	0.0068	1.0243
145	0.0062	1.0305
150	0.0056	1.0361
155	0.0050	1.0411
160	0.0044	1.0455
165	0.0038	1.0493
170	0.0032	1.0525
175	0.0026	1.0551
180	0.0020	1.0571

Table 2. Dimensionless Ordinates of the Intermediate-Duration Design Storm.

DIMENSIONLESS ORDINATES OF INTERMEDIATE-DURATION DESIGN STORM								
ELAPSED TIME (Hr)	INCRM ORDINATE	SUM ORDINATE	ELAPSED TIME (Hr)	INRM ORDINATE	SUM ORDINATE	ELAPSED TIME (Hr)	INCRM ORDINATE	SUM ORDINATE
0.00	0.0000	0.0000	6.17	0.0118	0.1972	12.17	0.0210	1.1731
0.17	0.0020	0.0020	6.33	0.0123	0.2095	12.33	0.0201	1.1932
0.33	0.0020	0.0040	6.50	0.0129	0.2224	12.50	0.0193	1.2125
0.50	0.0020	0.0060	6.67	0.0136	0.2360	12.67	0.0184	1.2309
0.67	0.0020	0.0080	6.83	0.0142	0.2502	12.83	0.0176	1.2485
0.83	0.0020	0.0100	7.00	0.0150	0.2652	13.00	0.0168	1.2653
1.00	0.0021	0.0121	7.17	0.0163	0.2815	13.17	0.0154	1.2807
1.17	0.0021	0.0142	7.33	0.0171	0.2986	13.33	0.0147	1.2954
1.33	0.0021	0.0163	7.50	0.0180	0.3166	13.50	0.0140	1.3094
1.50	0.0021	0.0184	7.67	0.0188	0.3354	13.67	0.0132	1.3226
1.67	0.0021	0.0205	7.83	0.0197	0.3551	13.83	0.0127	1.3353
1.83	0.0022	0.0227	8.00	0.0205	0.3756	14.00	0.0121	1.3474
2.00	0.0022	0.0249	8.17	0.0215	0.3971	14.17	0.0116	1.3590
2.17	0.0023	0.0272	8.33	0.0224	0.4195	14.33	0.0113	1.3703
2.33	0.0023	0.0295	8.50	0.0229	0.4424	14.50	0.0111	1.3814
2.50	0.0024	0.0319	8.67	0.0232	0.4656	14.67	0.0109	1.3923
2.67	0.0025	0.0344	8.83	0.0237	0.4893	14.83	0.0107	1.4030
2.83	0.0028	0.0372	9.00	0.0257	0.5150	15.00	0.0105	1.4135
3.00	0.0030	0.0402	9.17	0.0290	0.5440	15.17	0.0103	1.4238
3.17	0.0034	0.0436	9.33	0.0320	0.5760	15.33	0.0098	1.4336
3.33	0.0038	0.0474	9.50	0.0338	0.6098	15.50	0.0093	1.4429
3.50	0.0042	0.0516	9.67	0.0349	0.6447	15.67	0.0085	1.4514
3.67	0.0046	0.0562	9.83	0.0411	0.6858	15.83	0.0078	1.4592
3.83	0.0054	0.0616	10.00	0.0540	0.7398	16.00	0.0070	1.4662
4.00	0.0062	0.0678	10.17	0.0760	0.8158	16.17	0.0062	1.4724
4.17	0.0070	0.0748	10.33	0.0470	0.8628	16.33	0.0054	1.4778
4.33	0.0079	0.0827	10.50	0.0372	0.9000	16.50	0.0049	1.4827
4.50	0.0085	0.0912	10.67	0.0347	0.9347	16.67	0.0044	1.4871
4.67	0.0090	0.1002	10.83	0.0337	0.9684	16.83	0.0039	1.4910
4.83	0.0095	0.1097	11.00	0.0330	1.0014	17.00	0.0035	1.4945
5.00	0.0100	0.1197	11.17	0.0308	1.0322	17.17	0.0032	1.4977
5.17	0.0104	0.1301	11.33	0.0269	1.0591	17.33	0.0029	1.5006
5.33	0.0107	0.1408	11.50	0.0247	1.0838	17.50	0.0026	1.5032
5.50	0.0109	0.1517	11.67	0.0237	1.1075	17.67	0.0024	1.5056
5.67	0.0110	0.1627	11.83	0.0228	1.1303	17.83	0.0024	1.5080
5.83	0.0113	0.1740	12.00	0.0218	1.1521	18.00	0.0023	1.5103
6.00	0.0114	0.1854						

Table 3. Dimensionless Ordinates of Front-Loaded Long-Duration Design Storm.

DIMENSIONLESS ORDINATES OF INTERMEDIATE-DURATION DESIGN STORM								
ELAPSED TIME (Hr)	INCRM ORDINATE	SUM ORDINATE	ELAPSED TIME (Hr)	INRM ORDINATE	SUM ORDINATE	ELAPSED TIME (Hr)	INCRM ORDINATE	SUM ORDINATE
0.00	0.0000	0.0000	7.17	0.0018	0.0569	14.17	0.0072	0.2570
0.17	0.0001	0.0001	7.33	0.0019	0.0588	14.33	0.0073	0.2643
0.33	0.0003	0.0004	7.50	0.0019	0.0607	14.50	0.0074	0.2717
0.50	0.0005	0.0009	7.67	0.0020	0.0627	14.67	0.0075	0.2792
0.67	0.0007	0.0016	7.83	0.0022	0.0649	14.83	0.0076	0.2868
0.83	0.0009	0.0025	8.00	0.0024	0.0673	15.00	0.0077	0.2945
1.00	0.0010	0.0035	8.17	0.0026	0.0699	15.17	0.0078	0.3023
1.17	0.0011	0.0046	8.33	0.0028	0.0727	15.33	0.0078	0.3101
1.33	0.0012	0.0058	8.50	0.0030	0.0757	15.50	0.0078	0.3179
1.50	0.0013	0.0071	8.67	0.0032	0.0789	15.67	0.0079	0.3258
1.67	0.0013	0.0084	8.83	0.0034	0.0823	15.83	0.0079	0.3337
1.83	0.0013	0.0097	9.00	0.0036	0.0859	16.00	0.0079	0.3416
2.00	0.0013	0.0110	9.17	0.0038	0.0897	16.17	0.0081	0.3497
2.17	0.0013	0.0123	9.33	0.0040	0.0937	16.33	0.0082	0.3579
2.33	0.0013	0.0136	9.50	0.0042	0.0979	16.50	0.0082	0.3661
2.50	0.0014	0.0150	9.67	0.0045	0.1024	16.67	0.0093	0.3754
2.67	0.0014	0.0164	9.83	0.0047	0.1071	16.83	0.0099	0.3853
2.83	0.0014	0.0178	10.00	0.0048	0.1119	17.00	0.0102	0.3955
3.00	0.0014	0.0192	10.17	0.0049	0.1168	17.17	0.0104	0.4059
3.17	0.0014	0.0206	10.33	0.0049	0.1217	17.33	0.0107	0.4166
3.33	0.0014	0.0220	10.50	0.0049	0.1266	17.50	0.0114	0.4280
3.50	0.0014	0.0234	10.67	0.0050	0.1316	17.67	0.0118	0.4398
3.67	0.0014	0.0248	10.83	0.0051	0.1367	17.83	0.0142	0.4540
3.83	0.0014	0.0262	11.00	0.0051	0.1418	18.00	0.0220	0.4760
4.00	0.0014	0.0276	11.17	0.0053	0.1471	18.17	0.0290	0.5050
4.17	0.0014	0.0290	11.33	0.0053	0.1524	18.33	0.0160	0.5210
4.33	0.0015	0.0305	11.50	0.0054	0.1578	18.50	0.0127	0.5337
4.50	0.0015	0.0320	11.67	0.0054	0.1632	18.67	0.0116	0.5453
4.67	0.0015	0.0335	11.83	0.0054	0.1686	18.83	0.0110	0.5563
4.83	0.0015	0.0350	12.00	0.0055	0.1741	19.00	0.0106	0.5669
5.00	0.0015	0.0365	12.17	0.0055	0.1796	19.17	0.0102	0.5771
5.17	0.0015	0.0380	12.33	0.0056	0.1852	19.33	0.0096	0.5867
5.33	0.0015	0.0395	12.50	0.0057	0.1909	19.50	0.0082	0.5949
5.50	0.0015	0.0410	12.67	0.0058	0.1967	19.67	0.0082	0.6031
5.67	0.0015	0.0425	12.83	0.0060	0.2027	19.83	0.0082	0.6113
5.83	0.0015	0.0440	13.00	0.0062	0.2089	20.00	0.0081	0.6194
6.00	0.0015	0.0455	13.17	0.0064	0.2153	20.17	0.0080	0.6274
6.17	0.0015	0.0470	13.33	0.0066	0.2219	20.33	0.0079	0.6353
6.33	0.0015	0.0485	13.50	0.0068	0.2287	20.50	0.0079	0.6432

Table 3 (continued). Dimensionless Ordinates of Front-Loaded Long-Duration Design Storm.

DIMENSIONLESS ORDINATES OF INTERMEDIATE-DURATION DESIGN STORM								
ELAPSED TIME (Hr)	INCRM ORDINATE	SUM ORDINATE	ELAPSED TIME (Hr)	INRM ORDINATE	SUM ORDINATE	ELAPSED TIME (Hr)	INCRM ORDINATE	SUM ORDINATE
6.50	0.0016	0.0501	13.67	0.0069	0.2356	20.67	0.0078	0.6510
6.67	0.0016	0.0517	13.83	0.0070	0.2426	20.83	0.0078	0.6588
6.83	0.0017	0.0534	14.00	0.0072	0.2498	21.00	0.0077	0.6665
7.00	0.0017	0.0551						
21.17	0.0077	0.6742	30.17	0.0050	1.0069	39.17	0.0000	1.0984
21.33	0.0077	0.6819	30.33	0.0049	1.0118	39.33	0.0000	1.0984
21.50	0.0077	0.6896	30.50	0.0049	1.0167	39.50	0.0000	1.0984
21.67	0.0076	0.6972	30.67	0.0049	1.0216	39.67	0.0000	1.0984
21.83	0.0075	0.7047	30.83	0.0049	1.0265	39.83	0.0000	1.0984
22.00	0.0075	0.7122	31.00	0.0048	1.0313	40.00	0.0000	1.0984
22.17	0.0074	0.7196	31.17	0.0048	1.0361	40.17	0.0000	1.0984
22.33	0.0074	0.7270	31.33	0.0048	1.0409	40.33	0.0000	1.0984
22.50	0.0073	0.7343	31.50	0.0047	1.0456	40.50	0.0000	1.0984
22.67	0.0073	0.7416	31.67	0.0046	1.0502	40.67	0.0000	1.0984
22.83	0.0073	0.7489	31.83	0.0045	1.0547	40.83	0.0000	1.0984
23.00	0.0072	0.7561	32.00	0.0044	1.0591	41.00	0.0000	1.0984
23.17	0.0072	0.7633	32.17	0.0043	1.0634	41.17	0.0000	1.0984
23.33	0.0072	0.7705	32.33	0.0042	1.0676	41.33	0.0000	1.0984
23.50	0.0071	0.7776	32.50	0.0041	1.0717	41.50	0.0000	1.0984
23.67	0.0071	0.7847	32.67	0.0039	1.0756	41.67	0.0000	1.0984
23.83	0.0070	0.7917	32.83	0.0038	1.0794	41.83	0.0000	1.0984
24.00	0.0070	0.7987	33.00	0.0037	1.0831	42.00	0.0000	1.0984
24.17	0.0069	0.8056	33.17	0.0033	1.0864	42.17	0.0000	1.0984
24.33	0.0068	0.8124	33.33	0.0029	1.0893	42.33	0.0000	1.0984
24.50	0.0067	0.8191	33.50	0.0025	1.0918	42.50	0.0000	1.0984
24.67	0.0067	0.8258	33.67	0.0021	1.0939	42.67	0.0000	1.0984
24.83	0.0066	0.8324	33.83	0.0017	1.0956	42.83	0.0000	1.0984
25.00	0.0065	0.8389	34.00	0.0013	1.0969	43.00	0.0000	1.0984
25.17	0.0062	0.8451	34.17	0.0009	1.0978	43.17	0.0000	1.0984
25.33	0.0062	0.8513	34.33	0.0005	1.0983	43.33	0.0000	1.0984
25.50	0.0060	0.8573	34.50	0.0001	1.0984	43.50	0.0000	1.0984
25.67	0.0059	0.8632	34.67	0.0000	1.0984	43.67	0.0000	1.0984
25.83	0.0059	0.8691	34.83	0.0000	1.0984	43.83	0.0000	1.0984
26.00	0.0058	0.8749	35.00	0.0000	1.0984	44.00	0.0000	1.0984
26.17	0.0057	0.8806	35.17	0.0000	1.0984	44.17	0.0000	1.0984
26.33	0.0056	0.8862	35.33	0.0000	1.0984	44.33	0.0000	1.0984
26.50	0.0055	0.8917	35.50	0.0000	1.0984	44.50	0.0000	1.0984
26.67	0.0055	0.8972	35.67	0.0000	1.0984	44.67	0.0000	1.0984

Table 3 (continued). Dimensionless Ordinates of
Front-Loaded Long-Duration Design Storm.

DIMENSIONLESS ORDINATES OF INTERMEDIATE-DURATION DESIGN STORM								
ELAPSED TIME (Hr)	INCRM ORDINATE	SUM ORDINATE	ELAPSED TIME (Hr)	INRM ORDINATE	SUM ORDINATE	ELAPSED TIME (Hr)	INCRM ORDINATE	SUM ORDINATE
26.83	0.0055	0.9027	35.83	0.0000	1.0984	44.83	0.0000	1.0984
27.00	0.0055	0.9082	36.00	0.0000	1.0984	45.00	0.0000	1.0984
27.17	0.0054	0.9136	36.17	0.0000	1.0984	45.17	0.0000	1.0984
27.33	0.0054	0.9190	36.33	0.0000	1.0984	45.33	0.0000	1.0984
27.50	0.0054	0.9244	36.50	0.0000	1.0984	45.50	0.0000	1.0984
27.67	0.0053	0.9297	36.67	0.0000	1.0984	45.67	0.0000	1.0984
27.83	0.0053	0.9350	36.83	0.0000	1.0984	45.83	0.0000	1.0984
28.00	0.0053	0.9403	37.00	0.0000	1.0984	46.00	0.0000	1.0984
28.17	0.0053	0.9456	37.17	0.0000	1.0984	46.17	0.0000	1.0984
28.33	0.0052	0.9508	37.33	0.0000	1.0984	46.33	0.0000	1.0984
28.50	0.0052	0.9560	37.50	0.0000	1.0984	46.50	0.0000	1.0984
28.67	0.0052	0.9612	37.67	0.0000	1.0984	46.67	0.0000	1.0984
28.83	0.0052	0.9664	37.83	0.0000	1.0984	46.83	0.0000	1.0984
29.00	0.0052	0.9716	38.00	0.0000	1.0984	47.00	0.0000	1.0984
29.17	0.0051	0.9767	38.17	0.0000	1.0984	47.17	0.0000	1.0984
29.33	0.0051	0.9818	38.33	0.0000	1.0984	47.33	0.0000	1.0984
29.50	0.0051	0.9869	38.50	0.0000	1.0984	47.50	0.0000	1.0984
29.67	0.0050	0.9919	38.67	0.0000	1.0984	47.67	0.0001	1.0985
29.83	0.0050	0.9969	38.83	0.0000	1.0984	47.83	0.0002	1.0987
30.00	0.0050	1.0019	39.00	0.0000	1.0984	48.00	0.0003	1.0990
48.17	0.0004	1.0994	56.17	0.0026	1.2422			
48.33	0.0005	1.0999	56.33	0.0024	1.2446			
48.50	0.0006	1.1005	56.50	0.0023	1.2469			
48.67	0.0007	1.1012	56.67	0.0023	1.2492			
48.83	0.0007	1.1019	56.83	0.0022	1.2514			
49.00	0.0007	1.1026	57.00	0.0021	1.2535			
49.17	0.0007	1.1033	57.17	0.0019	1.2554			
49.33	0.0007	1.1040	57.33	0.0017	1.2571			
49.50	0.0007	1.1047	57.50	0.0016	1.2587			
49.67	0.0007	1.1054	57.67	0.0015	1.2602			
49.83	0.0007	1.1061	57.83	0.0015	1.2617			
50.00	0.0007	1.1068	58.00	0.0015	1.2632			
50.17	0.0007	1.1075	58.17	0.0015	1.2647			
50.33	0.0008	1.1083	58.33	0.0015	1.2662			
50.50	0.0009	1.1092	58.50	0.0015	1.2677			
50.67	0.0010	1.1102	58.67	0.0014	1.2691			
50.83	0.0011	1.1113	58.83	0.0014	1.2705			
51.00	0.0012	1.1125	59.00	0.0013	1.2718			

Table 3 (continued). Dimensionless Ordinates of
Front-Loaded Long-Duration Design Storm.

DIMENSIONLESS ORDINATES OF INTERMEDIATE-DURATION DESIGN STORM								
ELAPSED TIME (Hr)	INCRM ORDINATE	SUM ORDINATE	ELAPSED TIME (Hr)	INRM ORDINATE	SUM ORDINATE	ELAPSED TIME (Hr)	INCRM ORDINATE	SUM ORDINATE
51.17	0.0013	1.1138	59.17	0.0013	1.2731			
51.33	0.0014	1.1152	59.33	0.0012	1.2743			
51.50	0.0014	1.1166	59.50	0.0012	1.2755			
51.67	0.0014	1.1180	59.67	0.0011	1.2766			
51.83	0.0014	1.1194	59.83	0.0010	1.2776			
52.00	0.0015	1.1209	60.00	0.0009	1.2785			
52.17	0.0016	1.1225	60.17	0.0009	1.2794			
52.33	0.0018	1.1243	60.33	0.0008	1.2802			
52.50	0.0020	1.1263	60.50	0.0008	1.2810			
52.67	0.0021	1.1284	60.67	0.0007	1.2817			
52.83	0.0023	1.1307	60.83	0.0007	1.2824			
53.00	0.0023	1.1330	61.00	0.0007	1.2831			
53.17	0.0024	1.1354	61.17	0.0007	1.2838			
53.33	0.0026	1.1380	61.33	0.0007	1.2845			
53.50	0.0028	1.1408	61.50	0.0007	1.2852			
53.67	0.0032	1.1440	61.67	0.0007	1.2859			
53.83	0.0039	1.1479	61.83	0.0007	1.2866			
54.00	0.0048	1.1527	62.00	0.0007	1.2873			
54.17	0.0056	1.1583	62.17	0.0007	1.2880			
54.33	0.0076	1.1659	62.33	0.0007	1.2887			
54.50	0.0096	1.1755	62.50	0.0007	1.2894			
54.67	0.0133	1.1888	62.67	0.0006	1.2900			
54.83	0.0133	1.2021	62.83	0.0005	1.2905			
55.00	0.0096	1.2117	63.00	0.0004	1.2909			
55.17	0.0076	1.2193	63.17	0.0003	1.2912			
55.33	0.0056	1.2249	63.33	0.0002	1.2914			
55.50	0.0048	1.2297	63.50	0.0001	1.2915			
55.67	0.0039	1.2336	63.67	0.0000	1.2915			
55.83	0.0032	1.2368	63.83	0.0000	1.2915			
56.00	0.0028	1.2396	64.00	0.0000	1.2915			

Table 4. Dimensionless Ordinates of Back-Loaded Long-Duration Design Storm.

DIMENSIONLESS ORDINATES OF BACK-LOADED LONG-DURATION DESIGN STORM								
ELAPSED TIME (Hr)	INCRM ORDINATE	SUM ORDINATE	ELAPSED TIME (Hr)	INCRM ORDINATE	SUM ORDINATE	ELAPSED TIME (Hr)	INCRM ORDINATE	SUM ORDINATE
0.00	0.0000	0.0000	8.17	0.0039	0.1352	16.17	0.0000	0.1931
0.17	0.0001	0.0001	8.33	0.0032	0.1384	16.33	0.0000	0.1931
0.33	0.0002	0.0003	8.50	0.0028	0.1412	16.50	0.0000	0.1931
0.50	0.0003	0.0006	8.67	0.0026	0.1438	16.67	0.0000	0.1931
0.67	0.0004	0.0010	8.83	0.0024	0.1462	16.83	0.0000	0.1931
0.83	0.0005	0.0015	9.00	0.0023	0.1485	17.00	0.0000	0.1931
1.00	0.0006	0.0021	9.17	0.0023	0.1508	17.17	0.0000	0.1931
1.17	0.0007	0.0028	9.33	0.0022	0.1530	17.33	0.0000	0.1931
1.33	0.0007	0.0035	9.50	0.0021	0.1551	17.50	0.0000	0.1931
1.50	0.0007	0.0042	9.67	0.0019	0.1570	17.67	0.0000	0.1931
1.67	0.0007	0.0049	9.83	0.0017	0.1587	17.83	0.0000	0.1931
1.83	0.0007	0.0056	10.00	0.0016	0.1603	18.00	0.0000	0.1931
2.00	0.0007	0.0063	10.17	0.0015	0.1618	18.17	0.0000	0.1931
2.17	0.0007	0.0070	10.33	0.0015	0.1633	18.33	0.0000	0.1931
2.33	0.0007	0.0077	10.50	0.0015	0.1648	18.50	0.0000	0.1931
2.50	0.0007	0.0084	10.67	0.0015	0.1663	18.67	0.0000	0.1931
2.67	0.0007	0.0091	10.83	0.0015	0.1678	18.83	0.0000	0.1931
2.83	0.0008	0.0099	11.00	0.0015	0.1693	19.00	0.0000	0.1931
3.00	0.0009	0.0108	11.17	0.0014	0.1707	19.17	0.0000	0.1931
3.17	0.0010	0.0118	11.33	0.0014	0.1721	19.33	0.0000	0.1931
3.33	0.0011	0.0129	11.50	0.0013	0.1734	19.50	0.0000	0.1931
3.50	0.0012	0.0141	11.67	0.0013	0.1747	19.67	0.0000	0.1931
3.67	0.0013	0.0154	11.83	0.0012	0.1759	19.83	0.0000	0.1931
3.83	0.0014	0.0168	12.00	0.0012	0.1771	20.00	0.0000	0.1931
4.00	0.0014	0.0182	12.17	0.0011	0.1782	20.17	0.0000	0.1931
4.17	0.0014	0.0196	12.33	0.0010	0.1792	20.33	0.0000	0.1931
4.33	0.0014	0.0210	12.50	0.0009	0.1801	20.50	0.0000	0.1931
4.50	0.0015	0.0225	12.67	0.0009	0.1810	20.67	0.0000	0.1931
4.67	0.0016	0.0241	12.83	0.0008	0.1818	20.83	0.0000	0.1931
4.83	0.0018	0.0259	13.00	0.0008	0.1826	21.00	0.0000	0.1931
5.00	0.0020	0.0279	13.17	0.0007	0.1833	21.17	0.0000	0.1931
5.17	0.0021	0.0300	13.33	0.0007	0.1840	21.33	0.0000	0.1931
5.33	0.0023	0.0323	13.50	0.0007	0.1847	21.50	0.0000	0.1931
5.50	0.0023	0.0346	13.67	0.0007	0.1854	21.67	0.0000	0.1931
5.67	0.0024	0.0370	13.83	0.0007	0.1861	21.83	0.0000	0.1931
5.83	0.0026	0.0396	14.00	0.0007	0.1868	22.00	0.0000	0.1931
6.00	0.0028	0.0424	14.17	0.0007	0.1875	22.17	0.0000	0.1931
6.17	0.0032	0.0456	14.33	0.0007	0.1882	22.33	0.0000	0.1931
6.33	0.0039	0.0495	14.50	0.0007	0.1889	22.50	0.0000	0.1931
6.50	0.0048	0.0543	14.67	0.0007	0.1896	22.67	0.0000	0.1931

Table 4 (continued). Dimensionless Ordinates of Back-Loaded Long-Duration Design Storm.

DIMENSIONLESS ORDINATES OF BACK-LOADED LONG-DURATION DESIGN STORM								
ELAPSED TIME (Hr)	INCRM ORDINATE	SUM ORDINATE	ELAPSED TIME (Hr)	INCRM ORDINATE	SUM ORDINATE	ELAPSED TIME (Hr)	INCRM ORDINATE	SUM ORDINATE
6.67	0.0056	0.0599	14.83	0.0007	0.1903	22.83	0.0000	0.1931
6.83	0.0076	0.0675	15.00	0.0007	0.1910	23.00	0.0000	0.1931
7.00	0.0096	0.0771	15.17	0.0006	0.1916	23.17	0.0000	0.1931
7.17	0.0133	0.0904	15.33	0.0005	0.1921	23.33	0.0000	0.1931
7.33	0.0133	0.1037	15.50	0.0004	0.1925	23.50	0.0000	0.1931
7.50	0.0096	0.1133	15.67	0.0003	0.1928	23.67	0.0000	0.1931
7.67	0.0076	0.1209	15.83	0.0002	0.1930	23.83	0.0000	0.1931
7.83	0.0056	0.1265	16.00	0.0001	0.1931	24.00	0.0000	0.1931
8.00	0.0048	0.1313						
24.17	0.0000	0.1931	32.17	0.0014	0.2137	40.17	0.0053	0.3402
24.33	0.0000	0.1931	32.33	0.0014	0.2151	40.33	0.0053	0.3455
24.50	0.0000	0.1931	32.50	0.0014	0.2165	40.50	0.0054	0.3509
24.67	0.0000	0.1931	32.67	0.0014	0.2179	40.67	0.0054	0.3563
24.83	0.0000	0.1931	32.83	0.0014	0.2193	40.83	0.0054	0.3617
25.00	0.0000	0.1931	33.00	0.0014	0.2207	41.00	0.0055	0.3672
25.17	0.0000	0.1931	33.17	0.0014	0.2221	41.17	0.0055	0.3727
25.33	0.0000	0.1931	33.33	0.0015	0.2236	41.33	0.0056	0.3783
25.50	0.0000	0.1931	33.50	0.0015	0.2251	41.50	0.0057	0.3840
25.67	0.0000	0.1931	33.67	0.0015	0.2266	41.67	0.0058	0.3898
25.83	0.0000	0.1931	33.83	0.0015	0.2281	41.83	0.0060	0.3958
26.00	0.0000	0.1931	34.00	0.0015	0.2296	42.00	0.0062	0.4020
26.17	0.0000	0.1931	34.17	0.0015	0.2311	42.17	0.0064	0.4084
26.33	0.0000	0.1931	34.33	0.0015	0.2326	42.33	0.0066	0.4150
26.50	0.0000	0.1931	34.50	0.0015	0.2341	42.50	0.0068	0.4218
26.67	0.0000	0.1931	34.67	0.0015	0.2356	42.67	0.0069	0.4287
26.83	0.0000	0.1931	34.83	0.0015	0.2371	42.83	0.0070	0.4357
27.00	0.0000	0.1931	35.00	0.0015	0.2386	43.00	0.0072	0.4429
27.17	0.0000	0.1931	35.17	0.0015	0.2401	43.17	0.0072	0.4501
27.33	0.0000	0.1931	35.33	0.0015	0.2416	43.33	0.0073	0.4574
27.50	0.0000	0.1931	35.50	0.0016	0.2432	43.50	0.0074	0.4648
27.67	0.0000	0.1931	35.67	0.0016	0.2448	43.67	0.0075	0.4723
27.83	0.0000	0.1931	35.83	0.0017	0.2465	43.83	0.0076	0.4799
28.00	0.0000	0.1931	36.00	0.0017	0.2482	44.00	0.0077	0.4876
28.17	0.0000	0.1931	36.17	0.0018	0.2500	44.17	0.0078	0.4954
28.33	0.0000	0.1931	36.33	0.0019	0.2519	44.33	0.0078	0.5032
28.50	0.0000	0.1931	36.50	0.0019	0.2538	44.50	0.0078	0.5110
28.67	0.0000	0.1931	36.67	0.0020	0.2558	44.67	0.0079	0.5189
28.83	0.0000	0.1931	36.83	0.0022	0.2580	44.83	0.0079	0.5268
29.00	0.0000	0.1931	37.00	0.0024	0.2604	45.00	0.0079	0.5347

Table 4 (continued). Dimensionless Ordinates of Back-Loaded Long-Duration Design Storm.

DIMENSIONLESS ORDINATES OF BACK-LOADED LONG-DURATION DESIGN STORM								
ELAPSED TIME (Hr)	INCRM ORDINATE	SUM ORDINATE	ELAPSED TIME (Hr)	INCRM ORDINATE	SUM ORDINATE	ELAPSED TIME (Hr)	INCRM ORDINATE	SUM ORDINATE
29.17	0.0001	0.1932	37.17	0.0026	0.2630	45.17	0.0081	0.5428
29.33	0.0003	0.1935	37.33	0.0028	0.2658	45.33	0.0082	0.5510
29.50	0.0005	0.1940	37.50	0.0030	0.2688	45.50	0.0082	0.5592
29.67	0.0007	0.1947	37.67	0.0032	0.2720	45.67	0.0093	0.5685
29.83	0.0009	0.1956	37.83	0.0034	0.2754	45.83	0.0099	0.5784
30.00	0.0010	0.1966	38.00	0.0036	0.2790	46.00	0.0102	0.5886
30.17	0.0011	0.1977	38.17	0.0038	0.2828	46.17	0.0104	0.5990
30.33	0.0012	0.1989	38.33	0.0040	0.2868	46.33	0.0107	0.6097
30.50	0.0013	0.2002	38.50	0.0042	0.2910	46.50	0.0114	0.6211
30.67	0.0013	0.2015	38.67	0.0045	0.2955	46.67	0.0118	0.6329
30.83	0.0013	0.2028	38.83	0.0047	0.3002	46.83	0.0142	0.6471
31.00	0.0013	0.2041	39.00	0.0048	0.3050	47.00	0.0220	0.6691
31.17	0.0013	0.2054	39.17	0.0049	0.3099	47.17	0.0290	0.6981
31.33	0.0013	0.2067	39.33	0.0049	0.3148	47.33	0.0160	0.7141
31.50	0.0014	0.2081	39.50	0.0049	0.3197	47.50	0.0127	0.7268
31.67	0.0014	0.2095	39.67	0.0050	0.3247	47.67	0.0116	0.7384
31.83	0.0014	0.2109	39.83	0.0051	0.3298	47.83	0.0110	0.7494
32.00	0.0014	0.2123	40.00	0.0051	0.3349	48.00	0.0106	0.7600
48.17	0.0102	0.7702	56.17	0.0054	1.1067			
48.33	0.0096	0.7798	56.33	0.0054	1.1121			
48.50	0.0082	0.7880	56.50	0.0054	1.1175			
48.67	0.0082	0.7962	56.67	0.0053	1.1228			
48.83	0.0082	0.8044	56.83	0.0053	1.1281			
49.00	0.0081	0.8125	57.00	0.0053	1.1334			
49.17	0.0080	0.8205	57.17	0.0053	1.1387			
49.33	0.0079	0.8284	57.33	0.0052	1.1439			
49.50	0.0079	0.8363	57.50	0.0052	1.1491			
49.67	0.0078	0.8441	57.67	0.0052	1.1543			
49.83	0.0078	0.8519	57.83	0.0052	1.1595			
50.00	0.0077	0.8596	58.00	0.0052	1.1647			
50.17	0.0077	0.8673	58.17	0.0051	1.1698			
50.33	0.0077	0.8750	58.33	0.0051	1.1749			
50.50	0.0077	0.8827	58.50	0.0051	1.1800			
50.67	0.0076	0.8903	58.67	0.0050	1.1850			
50.83	0.0075	0.8978	58.83	0.0050	1.1900			
51.00	0.0075	0.9053	59.00	0.0050	1.1950			
51.17	0.0074	0.9127	59.17	0.0050	1.2000			
51.33	0.0074	0.9201	59.33	0.0049	1.2049			
51.50	0.0073	0.9274	59.50	0.0049	1.2098			

Table 4 (continued). Dimensionless Ordinates of Back-Loaded Long-Duration Design Storm.

DIMENSIONLESS ORDINATES OF BACK-LOADED LONG-DURATION DESIGN STORM								
ELAPSED TIME (Hr)	INCRM ORDINATE	SUM ORDINATE	ELAPSED TIME (Hr)	INCRM ORDINATE	SUM ORDINATE	ELAPSED TIME (Hr)	INCRM ORDINATE	SUM ORDINATE
51.67	0.0073	0.9347	59.67	0.0049	1.2147			
51.83	0.0073	0.9420	59.83	0.0049	1.2196			
52.00	0.0072	0.9492	60.00	0.0048	1.2244			
52.17	0.0072	0.9564	60.17	0.0048	1.2292			
52.33	0.0072	0.9636	60.33	0.0048	1.2340			
52.50	0.0071	0.9707	60.50	0.0047	1.2387			
52.67	0.0071	0.9778	60.67	0.0046	1.2433			
52.83	0.0070	0.9848	60.83	0.0045	1.2478			
53.00	0.0070	0.9918	61.00	0.0044	1.2522			
53.17	0.0069	0.9987	61.17	0.0043	1.2565			
53.33	0.0068	1.0055	61.33	0.0042	1.2607			
53.50	0.0067	1.0122	61.50	0.0041	1.2648			
53.67	0.0067	1.0189	61.67	0.0039	1.2687			
53.83	0.0066	1.0255	61.83	0.0038	1.2725			
54.00	0.0065	1.0320	62.00	0.0037	1.2762			
54.17	0.0062	1.0382	62.17	0.0033	1.2795			
54.33	0.0062	1.0444	62.33	0.0029	1.2824			
54.50	0.0060	1.0504	62.50	0.0025	1.2849			
54.67	0.0059	1.0563	62.67	0.0021	1.2870			
54.83	0.0059	1.0622	62.83	0.0017	1.2887			
55.00	0.0058	1.0680	63.00	0.0013	1.2900			
55.17	0.0057	1.0737	63.17	0.0009	1.2909			
55.33	0.0056	1.0793	63.33	0.0005	1.2914			
55.50	0.0055	1.0848	63.50	0.0001	1.2915			
55.67	0.0055	1.0903	63.67	0.0000	1.2915			
55.83	0.0055	1.0958	63.83	0.0000	1.2915			
56.00	0.0055	1.1013	64.00	0.0000	1.2915			

Table 5. Dimensionless Ordinates of 24-Hour Design Storm.

DIMENSIONLESS ORDINATES OF 24-HOUR DESIGN STORM								
ELAPSED TIME (Hr)	INCRM ORDINATE	SUM ORDINATE	ELAPSED TIME (Hr)	INCRM ORDINATE	SUM ORDINATE	ELAPSED TIME (Hr)	INCRM ORDINATE	SUM ORDINATE
0.00	0.0000	0.0000	7.17	0.0080	0.2596	14.17	0.0072	0.6769
0.17	0.0036	0.0036	7.33	0.0082	0.2678	14.33	0.0072	0.6841
0.33	0.0038	0.0074	7.50	0.0084	0.2762	14.50	0.0072	0.6913
0.50	0.0040	0.0114	7.67	0.0088	0.2850	14.67	0.0071	0.6984
0.67	0.0042	0.0156	7.83	0.0093	0.2943	14.83	0.0071	0.7055
0.83	0.0045	0.0201	8.00	0.0099	0.3042	15.00	0.0070	0.7125
1.00	0.0047	0.0248	8.17	0.0102	0.3144	15.17	0.0070	0.7195
1.17	0.0048	0.0296	8.33	0.0104	0.3248	15.33	0.0069	0.7264
1.33	0.0049	0.0345	8.50	0.0107	0.3355	15.50	0.0068	0.7332
1.50	0.0049	0.0394	8.67	0.0114	0.3469	15.67	0.0067	0.7399
1.67	0.0049	0.0443	8.83	0.0127	0.3596	15.83	0.0066	0.7465
1.83	0.0050	0.0493	9.00	0.0142	0.3738	16.00	0.0065	0.7530
2.00	0.0051	0.0544	9.17	0.0220	0.3958	16.17	0.0064	0.7594
2.17	0.0051	0.0595	9.33	0.0290	0.4248	16.33	0.0063	0.7657
2.33	0.0053	0.0648	9.50	0.0160	0.4408	16.50	0.0062	0.7719
2.50	0.0053	0.0701	9.67	0.0127	0.4535	16.67	0.0060	0.7779
2.67	0.0054	0.0755	9.83	0.0116	0.4651	16.83	0.0059	0.7838
2.83	0.0054	0.0809	10.00	0.0110	0.4761	17.00	0.0059	0.7897
3.00	0.0054	0.0863	10.17	0.0106	0.4867	17.17	0.0058	0.7955
3.17	0.0055	0.0918	10.33	0.0102	0.4969	17.33	0.0057	0.8012
3.33	0.0055	0.0973	10.50	0.0096	0.5065	17.50	0.0056	0.8068
3.50	0.0056	0.1029	10.67	0.0089	0.5154	17.67	0.0055	0.8123
3.67	0.0057	0.1086	10.83	0.0085	0.5239	17.83	0.0055	0.8178
3.83	0.0058	0.1144	11.00	0.0083	0.5322	18.00	0.0055	0.8233
4.00	0.0060	0.1204	11.17	0.0082	0.5404	18.17	0.0055	0.8288
4.17	0.0062	0.1266	11.33	0.0081	0.5485	18.33	0.0054	0.8342
4.33	0.0064	0.1330	11.50	0.0080	0.5565	18.50	0.0054	0.8396
4.50	0.0066	0.1396	11.67	0.0079	0.5644	18.67	0.0054	0.8450
4.67	0.0068	0.1464	11.83	0.0078	0.5722	18.83	0.0053	0.8503
4.83	0.0069	0.1533	12.00	0.0078	0.5800	19.00	0.0053	0.8556
5.00	0.0070	0.1603	12.17	0.0077	0.5877	19.17	0.0053	0.8609
5.17	0.0072	0.1675	12.33	0.0077	0.5954	19.33	0.0053	0.8662
5.33	0.0072	0.1747	12.50	0.0076	0.6030	19.50	0.0052	0.8714
5.50	0.0073	0.1820	12.67	0.0076	0.6106	19.67	0.0052	0.8766
5.67	0.0074	0.1894	12.83	0.0075	0.6181	19.83	0.0052	0.8818
5.83	0.0075	0.1969	13.00	0.0075	0.6256	20.00	0.0052	0.8870
6.00	0.0076	0.2045	13.17	0.0074	0.6330	20.17	0.0052	0.8922
6.17	0.0077	0.2122	13.33	0.0074	0.6404	20.33	0.0051	0.8973
6.33	0.0078	0.2200	13.50	0.0074	0.6478	20.50	0.0051	0.9024
6.50	0.0078	0.2278	13.67	0.0073	0.6551	20.67	0.0051	0.9075

Table 5 (continued). Dimensionless Ordinates of 24-Hour Design Storm.

DIMENSIONLESS ORDINATES OF 24-HOUR DESIGN STORM								
ELAPSED TIME (Hr)	INCRM ORDINATE	SUM ORDINATE	ELAPSED TIME (Hr)	INCRM ORDINATE	SUM ORDINATE	ELAPSED TIME (Hr)	INCRM ORDINATE	SUM ORDINATE
6.67	0.0079	0.2357	13.83	0.0073	0.6624	20.83	0.0050	0.9125
6.83	0.0079	0.2436	14.00	0.0073	0.6697	21.00	0.0050	0.9175
7.00	0.0080	0.2516						
21.17	0.0050	0.9225						
21.33	0.0050	0.9275						
21.50	0.0049	0.9324						
21.67	0.0049	0.9373						
21.83	0.0049	0.9422						
22.00	0.0049	0.9471						
22.17	0.0048	0.9519						
22.33	0.0048	0.9567						
22.50	0.0048	0.9615						
22.67	0.0047	0.9662						
22.83	0.0046	0.9708						
23.00	0.0045	0.9753						
23.17	0.0044	0.9797						
23.33	0.0043	0.9840						
23.50	0.0042	0.9882						
23.67	0.0041	0.9923						
23.83	0.0039	0.9962						
24.00	0.0038	1.0000						

Attachment 2

Precipitation Magnitude-Frequency
Estimates for SPU Rain Gauge Locations
(~~up to 2012 data only~~)

ATTACHMENT 2 – PRECIPITATION MAGNITUDE-FREQUENCY ESTIMATES FOR SPU RAIN GAUGE LOCATIONS (~~UP TO 2012 DATA ONLY~~)

This appendix contains adapted text and excerpted tables and figures from *Analysis of Precipitation-Frequency and Storm Characteristics for the City of Seattle* (MGS Engineering Consultants, Inc. for Seattle Public Utilities, January 2013). [A majority of the analysis presented here is from rain gauge data ending in 2012. Tables 1, 3, and 4 were updated based on a study performed in 2020. Updated information may be obtained from the SPU Rain Gauge Network Data Steward as it becomes available.](#)

The results of homogeneity analyses indicate that at-site mean values for precipitation do not vary across the Seattle Metropolitan Area for durations of 3 hours and less. Accordingly, one set of intensity-duration-frequency (IDF) curves can be developed that are applicable to the Seattle Metropolitan Area. Table 1 and Figures 1 and 2 provide precipitation intensities and IDF curves representative of the Seattle Metropolitan Area for durations from 5 to 180 minutes.

Table 1. Intensity-Duration-Frequency Values for Durations from 5 Minutes Through 180 Minutes for Selected Recurrence Intervals for the Seattle Metropolitan Area.

<u>DURATION</u> <u>(minutes)</u>	<u>DURATION</u> <u>(hours</u> <u>minutes)</u>	PRECIPITATION INTENSITIES (in/hr)							
		RECURRENCE INTERVAL (years)							
		6-Month	2-Yr	5-Yr	10-Yr	20-Yr	25-Yr	50-Yr	100-Yr
<u>5</u>	<u>0.08335</u>	<u>1.024.04</u>	<u>1.314.60</u>	<u>1.622.08</u>	<u>2.062.45</u>	<u>2.392.92</u>	<u>2.793.08</u>	<u>2.923.64</u>	<u>3.354.20</u>
<u>6</u>	<u>0.10006</u>	<u>0.970.92</u>	<u>1.234.45</u>	<u>1.524.87</u>	<u>1.932.24</u>	<u>2.232.62</u>	<u>2.602.76</u>	<u>2.723.23</u>	<u>3.103.75</u>
<u>8</u>	<u>0.13338</u>	<u>0.860.80</u>	<u>1.084.24</u>	<u>1.334.59</u>	<u>1.674.87</u>	<u>1.942.24</u>	<u>2.252.32</u>	<u>2.352.74</u>	<u>2.683.13</u>
<u>10</u>	<u>0.16674</u>	<u>0.760.74</u>	<u>0.964.10</u>	<u>1.174.40</u>	<u>1.484.64</u>	<u>1.704.93</u>	<u>1.982.03</u>	<u>2.072.36</u>	<u>2.362.72</u>
<u>12</u>	<u>0.20004</u>	<u>0.690.65</u>	<u>0.864.00</u>	<u>1.054.27</u>	<u>1.324.48</u>	<u>1.534.74</u>	<u>1.774.82</u>	<u>1.852.14</u>	<u>2.112.43</u>
<u>15</u>	<u>0.25004</u>	<u>0.600.58</u>	<u>0.750.88</u>	<u>0.924.12</u>	<u>1.154.30</u>	<u>1.334.52</u>	<u>1.544.60</u>	<u>1.614.84</u>	<u>1.832.14</u>
<u>20</u>	<u>0.33332</u>	<u>0.510.50</u>	<u>0.630.75</u>	<u>0.770.95</u>	<u>0.964.10</u>	<u>1.114.28</u>	<u>1.284.34</u>	<u>1.344.54</u>	<u>1.534.76</u>
<u>25</u>	<u>0.41672</u>	<u>0.450.45</u>	<u>0.560.67</u>	<u>0.670.84</u>	<u>0.840.97</u>	<u>0.964.12</u>	<u>1.114.18</u>	<u>1.164.35</u>	<u>1.324.53</u>
<u>30</u>	<u>0.50003</u>	<u>0.410.44</u>	<u>0.500.64</u>	<u>0.600.76</u>	<u>0.750.87</u>	<u>0.864.04</u>	<u>1.004.05</u>	<u>1.044.24</u>	<u>1.184.37</u>
<u>35</u>	<u>0.58333</u>	<u>0.370.38</u>	<u>0.460.56</u>	<u>0.550.69</u>	<u>0.690.80</u>	<u>0.790.92</u>	<u>0.910.96</u>	<u>0.954.10</u>	<u>1.074.24</u>
<u>40</u>	<u>0.66674</u>	<u>0.350.35</u>	<u>0.430.52</u>	<u>0.510.64</u>	<u>0.640.74</u>	<u>0.730.85</u>	<u>0.840.89</u>	<u>0.874.04</u>	<u>0.994.14</u>
<u>45</u>	<u>0.75004</u>	<u>0.330.33</u>	<u>0.400.49</u>	<u>0.480.60</u>	<u>0.600.69</u>	<u>0.680.79</u>	<u>0.780.83</u>	<u>0.820.94</u>	<u>0.924.06</u>
<u>50</u>	<u>0.83335</u>	<u>0.310.32</u>	<u>0.380.46</u>	<u>0.460.57</u>	<u>0.560.65</u>	<u>0.640.74</u>	<u>0.740.78</u>	<u>0.770.88</u>	<u>0.870.99</u>
<u>55</u>	<u>0.91675</u>	<u>0.300.30</u>	<u>0.360.44</u>	<u>0.430.54</u>	<u>0.530.64</u>	<u>0.610.70</u>	<u>0.700.73</u>	<u>0.730.83</u>	<u>0.820.94</u>
<u>60</u>	<u>1.00006</u>	<u>0.290.29</u>	<u>0.350.42</u>	<u>0.420.54</u>	<u>0.510.58</u>	<u>0.580.67</u>	<u>0.660.70</u>	<u>0.690.79</u>	<u>0.780.89</u>
<u>65</u>	<u>1.08336</u>	<u>0.280.28</u>	<u>0.340.40</u>	<u>0.400.49</u>	<u>0.490.56</u>	<u>0.560.64</u>	<u>0.630.66</u>	<u>0.660.75</u>	<u>0.740.84</u>
<u>70</u>	<u>1.16677</u>	<u>0.270.27</u>	<u>0.320.38</u>	<u>0.380.47</u>	<u>0.470.53</u>	<u>0.530.64</u>	<u>0.610.64</u>	<u>0.630.72</u>	<u>0.710.80</u>
<u>80</u>	<u>1.33338</u>	<u>0.250.25</u>	<u>0.300.36</u>	<u>0.360.43</u>	<u>0.440.49</u>	<u>0.500.56</u>	<u>0.570.59</u>	<u>0.590.66</u>	<u>0.660.74</u>
<u>90</u>	<u>1.50009</u>	<u>0.240.24</u>	<u>0.290.33</u>	<u>0.340.41</u>	<u>0.410.46</u>	<u>0.470.52</u>	<u>0.530.55</u>	<u>0.550.62</u>	<u>0.620.69</u>
<u>100</u>	<u>1.66674</u>	<u>0.230.22</u>	<u>0.270.32</u>	<u>0.320.38</u>	<u>0.390.43</u>	<u>0.440.49</u>	<u>0.500.54</u>	<u>0.520.58</u>	<u>0.580.64</u>
<u>120</u>	<u>2.00004</u>	<u>0.210.20</u>	<u>0.250.29</u>	<u>0.300.35</u>	<u>0.360.39</u>	<u>0.400.44</u>	<u>0.460.46</u>	<u>0.470.52</u>	<u>0.530.57</u>
<u>140</u>	<u>2.33334</u>	<u>0.200.19</u>	<u>0.240.26</u>	<u>0.280.32</u>	<u>0.330.36</u>	<u>0.370.40</u>	<u>0.420.42</u>	<u>0.440.47</u>	<u>0.490.52</u>
<u>160</u>	<u>2.66674</u>	<u>0.190.18</u>	<u>0.220.24</u>	<u>0.260.29</u>	<u>0.310.33</u>	<u>0.350.37</u>	<u>0.390.39</u>	<u>0.410.43</u>	<u>0.450.48</u>
<u>180</u>	<u>3.00004</u>	<u>0.180.17</u>	<u>0.210.23</u>	<u>0.250.27</u>	<u>0.290.34</u>	<u>0.330.35</u>	<u>0.370.36</u>	<u>0.380.40</u>	<u>0.420.45</u>

Table 2. Two-Hour Precipitation Magnitude-Frequency Values for Selected Recurrence Intervals for the Seattle Metropolitan Area.

Recurrence Interval	2-Hour Total (inches)
6-month	0.40
2-yr	0.58
5-yr	0.70
10-yr	0.78
20-yr	0.88
25-yr	0.92
50-yr	1.04
100-yr	1.14

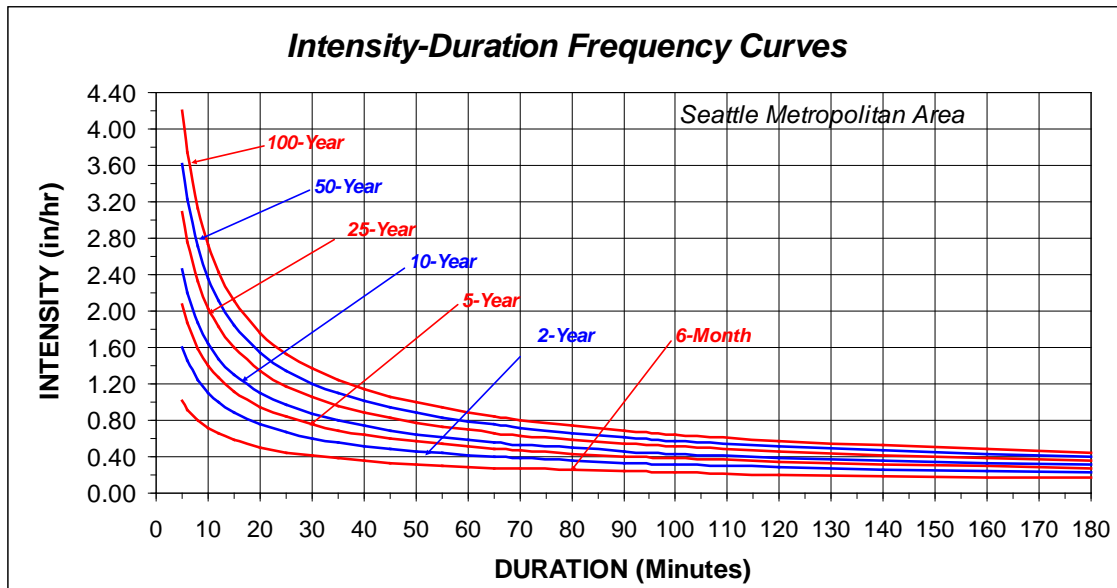

Figure 1. Intensity-Duration-Frequency Curves for the Seattle Metropolitan Area.

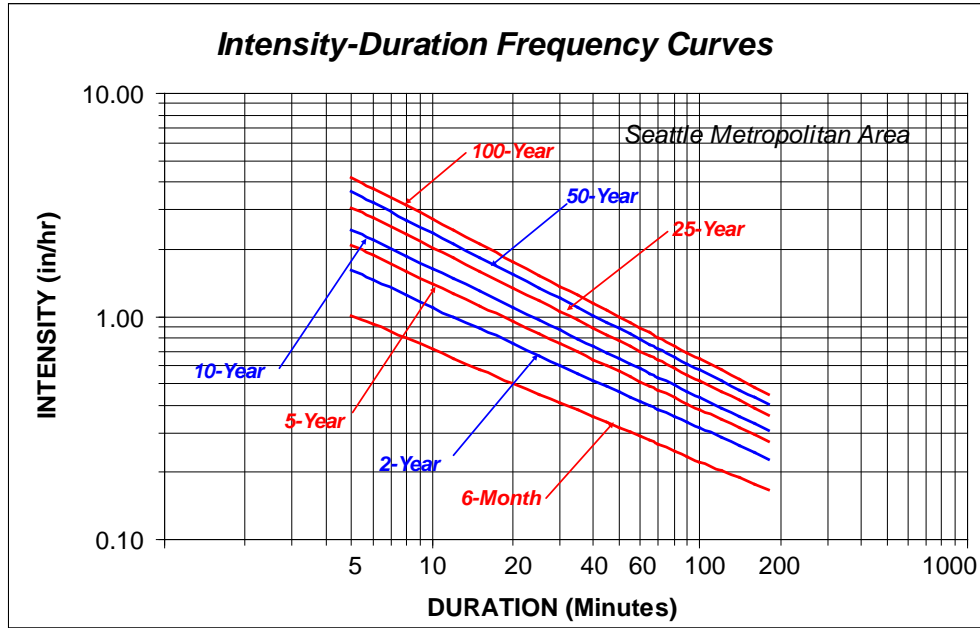

Figure 2. Intensity-Duration-Frequency Curves for the Seattle Metropolitan Area.

The following tables and figures contain estimates of precipitation-frequency values for durations of 6 hours, 12 hours, 24 hours, 48 hours, and 7 days for locations of SPU precipitation gauges (Table 2) in both tabular format and as magnitude-frequency curves. These precipitation values are based on estimates of the at-site mean values for the location of SPU gauges (Table 3) based on the spatial analysis of precipitation (gridded datasets) and the applicable regional growth curves obtained from the regional frequency analyses. Corrections have been applied to provide equivalent partial duration series estimates for frequently occurring events (5 times/year, 2 times/year, once/year, 2-year, and 5-year recurrence intervals).

Table 3. Listing of City of Seattle (SPU) Precipitation Gauges.

Station ID	Station Name	Latitude	Longitude	Year Start	Year End	Gauge Type
RG0145-S001	Haller Lake Shop	47.7211	122.3431	1965	20202003	TB
RG0245-S002	Magnuson Park/Mathews Beach Pump Stn	47.6950	122.2731	1969	20202003	TB
RG0345-S003	UW Hydraulics Lab	47.6481	122.3081	1965	20202003	TB
RG0445-S004	Maple Leaf Reservoir	47.6900	122.3119	1965	20202003	TB
RG0545-S005	Fauntleroy Ferry Dock	47.5231	122.3919	1968	20202003	TB
RG0745-S007	Whitman Middle School	47.6961	122.3769	1965	20202003	TB
RG0845-S008	Ballard Locks	47.6650	122.3969	1965	20202003	TB
RG0945-S009	Woodland Park Zoo	47.6681	122.3539	1965	20202003	TB
RG1045-S010	Rainier View-Ave Elementary	47.5000	122.2600	1968	20102003	TB
RG1145-S011	Metro-KC Denny Regulating	47.6169	122.3550	1970	20202003	TB
RG1245-S012	Catherine Blaine Elementary School Jr	47.6419	122.3969	1965	20202003	TB
RG1445-S014	Lafayette Elementary School/West Seattle High School	47.5781	122.3819	1965	20202003	TB
RG1545-S015	Puget Sound Clean Air Monitoring Station/Metro-KC Diagonal Pump	47.5619	122.3400	1965	20202003	TB
RG1645-S016	Metro-KC E Marginal Way	47.5350	122.3139	1970	20202003	TB
RG1745-S017	West Seattle Reservoir Treatment Engr Shop	47.5211	122.3450	1965	20202003	TB
RG1845-S018	Aki Kurose Middle School/Hillman Engr Shop	47.5481	122.2750	1965	20202003	TB
RG2045-S020	TT Minor Elementary	47.6119	122.3069	1975	20112003	TB
RG25	Garfield Community Center	47.6076	-122.3020	2010	2020	TB
RG30	Rainier Beach Public Library	47.5214	-122.2700	2011	2020	TB
RG32	Beacon Telemetry Shack	47.5698	-122.3080	2016	2020	TB
RG33	Fire Station #38	47.6688	-122.2840	2016	2020	TB
RG34	Fire Station #39	47.7213	-122.2970	2016	2020	TB
RG35	Capitol Hill Library	47.6229	-122.3220	2016	2020	TB
RG36	High Point Library	47.5480	-122.3760	2016	2020	TB
45-7473	Seattle Tacoma Airport	47.4500	122.3000	19401965	20202002	HR

TB – Tipping Bucket

HR – NOAA Hourly Gauge

Table 4. Listing of Best Estimate At-site Mean Values for City of Seattle (SPU) Precipitation Gauges.

<u>Best Estimate At-Site Mean Values (inches)</u>							
<u>Station ID</u>	<u>Station Name</u>	<u>6 Hr</u>	<u>12 Hr</u>	<u>24 Hr</u>	<u>48 Hr</u>	<u>72 Hr</u>	<u>7 Day</u>
RG01	Haller Lake Shop	1.020	1.495	2.000	2.465	2.985	4.290
RG02	Mathews Beach Pump Stn	1.030	1.525	2.105	2.595	3.085	4.470
RG03	UW Hydraulics Lab	1.055	1.535	2.075	2.570	3.060	4.330
RG04	Maple Leaf Reservoir	1.035	1.520	2.065	2.585	3.105	4.435
RG05	Fauntleroy Ferry Dock	1.070	1.560	2.115	2.675	3.105	4.260
RG07	Whitman Middle School	1.050	1.535	2.050	2.535	3.095	4.510
RG08	Ballard Locks	1.055	1.545	2.065	2.545	3.045	4.335
RG09	Woodland Park Zoo	1.020	1.480	1.980	2.465	2.935	4.190
RG10	Rainier Ave Elementary	1.100	1.595	2.250	2.825	3.345	4.630
RG11	Metro-KC Denny Regulating	1.025	1.500	2.020	2.520	2.955	4.100
RG12	Catherine Blaine Jr	1.045	1.530	2.045	2.550	3.080	4.435
RG14	West Seattle High School	1.065	1.570	2.110	2.665	3.205	4.495
RG15	Metro-KC Diagonal Pump	1.055	1.535	2.095	2.655	3.135	4.335
RG16	Metro-KC E Marginal Way	1.065	1.545	2.160	2.700	3.205	4.440
RG17	West Seattle Engr Shop	1.100	1.590	2.210	2.785	3.325	4.665
RG18	Hillman Engr Shop	1.080	1.560	2.165	2.735	3.235	4.510
RG20	TT Minor Elementary	1.080	1.595	2.150	2.720	3.170	4.440
RG25	Garfield Community Center	1.080	1.565	2.150	2.720	3.170	4.440
RG30	Rainier Beach Public Library	1.100	1.595	2.250	2.825	3.345	4.630
RG32	Beacon Telemetry Shack	1.070	1.555	2.150	2.700	3.195	4.465
RG33	Fire Station #38	1.045	1.525	2.090	2.600	3.100	4.430
RG34	Fire Station #39	1.025	1.510	2.045	2.525	3.030	4.390
RG35	Capitol Hill Library	1.055	1.540	2.100	2.625	3.125	4.415
RG36	High Point Library	1.070	1.560	2.120	2.670	3.165	4.400

<u>At-Site Mean Values (in)</u>							
<u>Station ID</u>	<u>Station Name</u>	<u>6-Hr</u>	<u>12-Hr</u>	<u>24-Hr</u>	<u>48-Hr</u>	<u>72-Hr</u>	<u>7-Day</u>
45-S001	Haller Lake Shop	1.02	1.45	1.97	2.40	2.88	4.05
45-S002	Magnusson Park	1.04	1.50	2.03	2.48	2.99	4.21
45-S003	UW Hydraulics Lab	1.04	1.50	2.04	2.50	3.00	4.23
45-S004	Maple Leaf Reservoir	1.04	1.50	2.03	2.48	2.99	4.21
45-S005	Fauntleroy Ferry Dock	1.07	1.56	2.12	2.61	3.14	4.45
45-S007	Whitman Middle School	1.04	1.50	2.03	2.48	2.99	4.21
45-S008	Ballard Locks	1.05	1.51	2.05	2.51	3.02	4.26
45-S009	Woodland Park Zoo	1.04	1.50	2.04	2.50	3.00	4.23
45-S010	Rainier View Elementary	1.10	1.60	2.18	2.69	3.25	4.60
45-S014	Metro-KC Denny Regulating	1.05	1.52	2.06	2.52	3.04	4.29
45-S012	Catherine Blaine Elementary School	1.05	1.51	2.05	2.51	3.02	4.26

45-S014	Lafayette Elementary School	1.07	1.55	2.10	2.58	3.11	4.39
45-S015	Puget Sound Clean Air Monitoring Station	1.05	1.52	2.07	2.54	3.06	4.34
45-S016	Metro KC E Marginal Way	1.06	1.54	2.09	2.57	3.09	4.37
45-S017	West Seattle Reservoir Treatment Shop	1.10	1.60	2.18	2.69	3.25	4.60
45-S018	Aki Kurose Middle School	1.06	1.53	2.08	2.55	3.07	4.34
45-S020	TT Minor Elementary	1.06	1.53	2.08	2.55	3.07	4.34
45-7473	Seattle Tacoma Airport	1.11	1.62	2.24	2.73	3.30	4.68

Table 5. Precipitation-Magnitude-Frequency Estimates for of SPU Gauge 01.

Duration (hr)	Precipitation (in)										
	Recurrence Interval (years)										
	0.5-Yr	1-Yr	2-Yr	5-Yr	10-Yr		25-Yr	50-Yr	100-Yr	500-Yr	
6		0.75	0.89	1.03	1.23	1.37		1.58	1.74	1.91	2.31
12		1.05	1.26	1.48	1.78	1.99		2.32	2.56	2.81	3.40
24		1.39	1.70	2.01	2.44	2.75		3.22	3.58	3.94	4.83
48		1.67	2.05	2.45	2.98	3.37		3.96	4.41	4.86	5.97
72		2.05	2.50	2.95	3.56	3.99		4.63	5.11	5.59	6.72
168		2.92	3.55	4.18	4.98	5.53		6.32	6.89	7.44	8.67

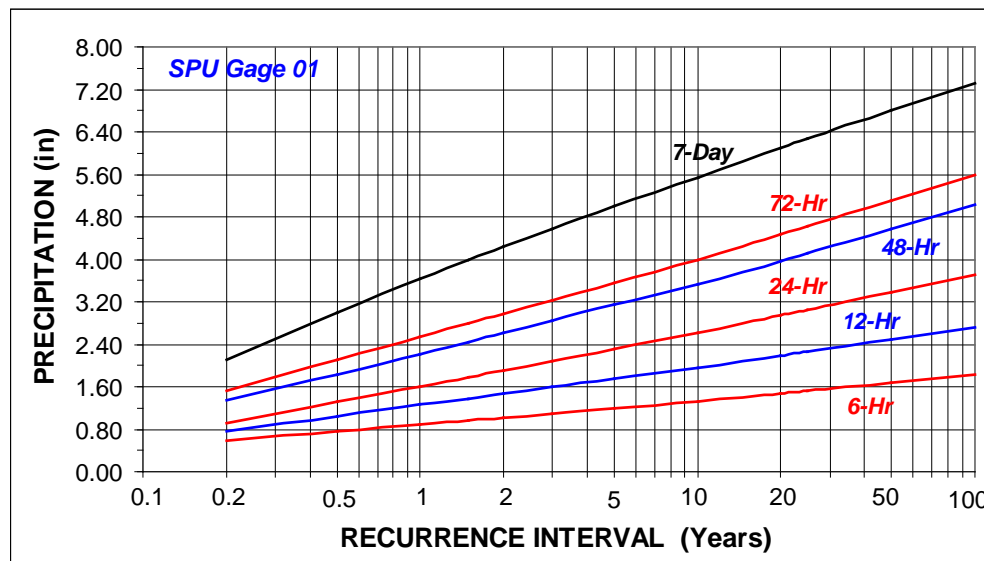

Figure 3. Precipitation-Magnitude-Frequency Estimates for of SPU Gauge 01.

Table 6. Precipitation-Magnitude-Frequency Estimates for SPU Gauge 02.

Duration (hr)	Precipitation (in)										
	Recurrence Interval (years)										
		0.5-Yr	1-Yr	2-Yr	5-Yr	10-Yr		25-Yr	50-Yr	100-Yr	500-Yr
6		0.77	0.91	1.06	1.26	1.40		1.62	1.78	1.95	2.36
12		1.08	1.30	1.53	1.83	2.05		2.38	2.64	2.89	3.50
24		1.44	1.75	2.07	2.51	2.83		3.31	3.68	4.06	4.97
48		1.73	2.12	2.53	3.08	3.49		4.09	4.56	5.03	6.18
72		2.13	2.59	3.06	3.69	4.13		4.80	5.30	5.79	6.97
168		3.03	3.69	4.34	5.17	5.75		6.57	7.16	7.74	9.01

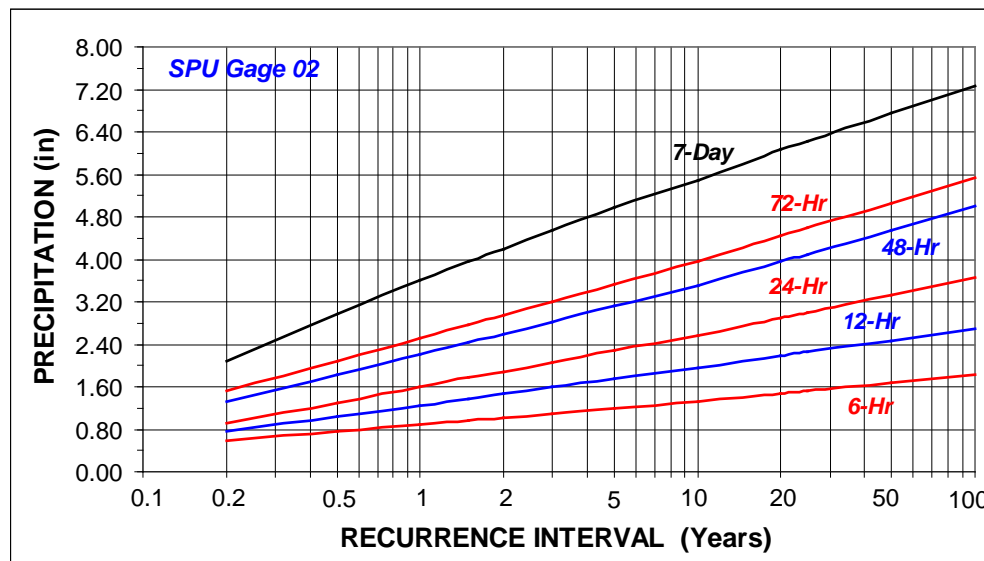

Figure 4. Precipitation-Magnitude-Frequency Estimates for SPU Gauge 02.

Table 7. Precipitation-Magnitude-Frequency Estimates for SPU Gauge 03.

Duration (hr)	Precipitation (in)										
	Recurrence Interval (years)										
	0.5-Yr	1-Yr	2-Yr	5-Yr	10-Yr	25-Yr	50-Yr	100-Yr	500-Yr		
6	0.77	0.91	1.06	1.26	1.41	1.62	1.79	1.96	2.37		
12	1.09	1.31	1.53	1.84	2.06	2.39	2.65	2.90	3.52		
24	1.44	1.75	2.08	2.52	2.84	3.33	3.70	4.08	4.99		
48	1.74	2.14	2.55	3.10	3.51	4.12	4.59	5.06	6.22		
72	2.14	2.60	3.08	3.71	4.16	4.83	5.33	5.83	7.01		
168	3.05	3.71	4.37	5.21	5.79	6.61	7.21	7.78	9.07		

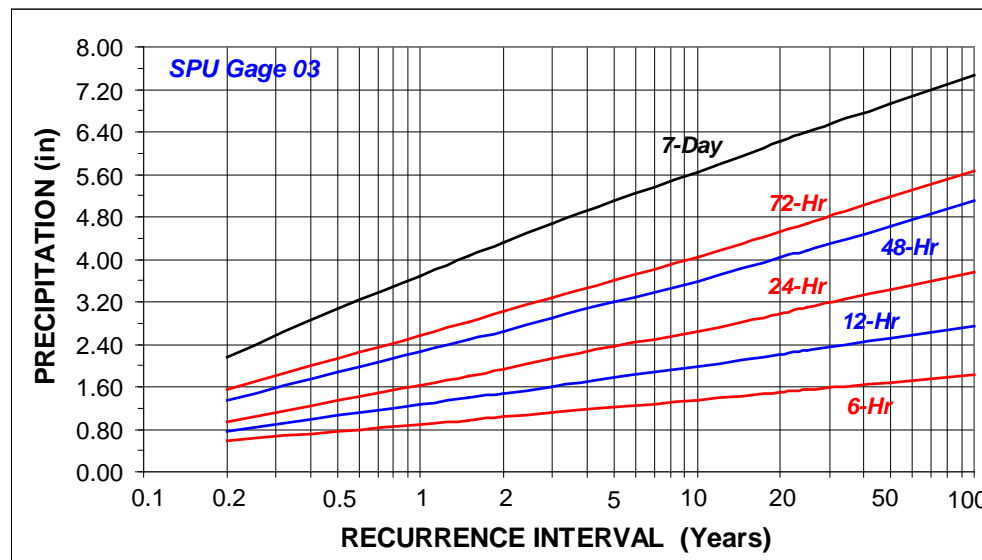

Figure 5. Precipitation-Magnitude-Frequency Estimates for SPU Gauge 03.

Table 8. Precipitation-Magnitude-Frequency Estimates for SPU Gauge 04.

Duration (hr)	Precipitation (in)										
	Recurrence Interval (years)										
		0.5-Yr	1-Yr	2-Yr	5-Yr	10-Yr		25-Yr	50-Yr	100-Yr	500-Yr
6		0.77	0.91	1.06	1.26	1.40		1.62	1.78	1.95	2.36
12		1.08	1.30	1.53	1.83	2.05		2.38	2.64	2.89	3.50
24		1.44	1.75	2.07	2.51	2.83		3.31	3.68	4.06	4.97
48		1.73	2.12	2.53	3.08	3.49		4.09	4.56	5.03	6.18
72		2.13	2.59	3.06	3.69	4.13		4.80	5.30	5.79	6.97
168		3.03	3.69	4.34	5.17	5.75		6.57	7.16	7.74	9.01

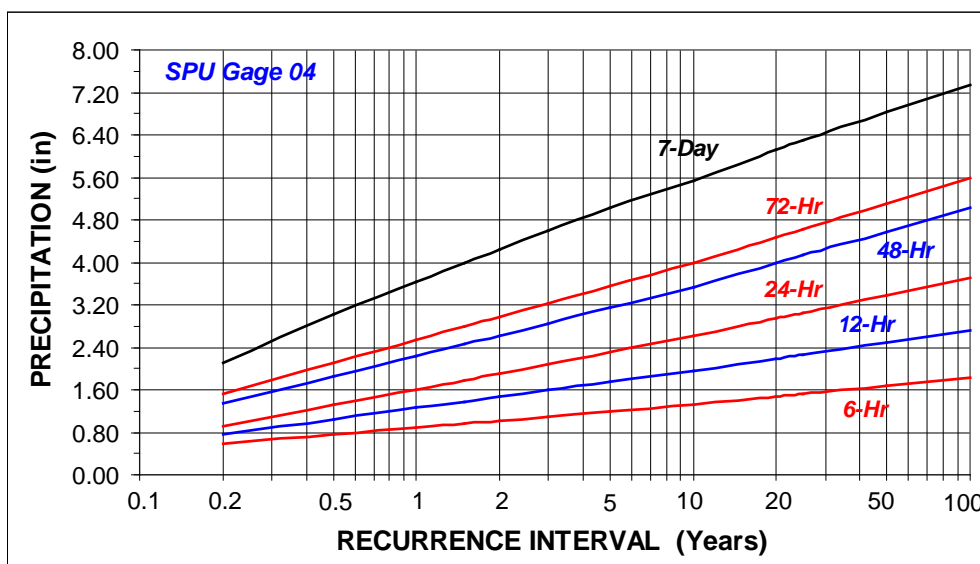

Figure 6. Precipitation-Magnitude-Frequency Estimates for SPU Gauge 04.

Table 9. Precipitation-Magnitude-Frequency Estimates for SPU Gauge 05.

Duration (hr)	Precipitation (in)										
	Recurrence Interval (years)										
	0.5-Yr	1-Yr	2-Yr	5-Yr	10-Yr		25-Yr	50-Yr	100-Yr	500-Yr	
6	0.80	0.94	1.09	1.30	1.45		1.67	1.85	2.02	2.44	
12	1.13	1.36	1.59	1.91	2.14		2.48	2.75	3.01	3.65	
24	1.50	1.82	2.16	2.62	2.95		3.45	3.84	4.23	5.18	
48	1.82	2.23	2.66	3.24	3.66		4.30	4.79	5.29	6.50	
72	2.24	2.72	3.22	3.88	4.35		5.05	5.58	6.10	7.33	
168	3.20	3.90	4.59	5.47	6.08		6.94	7.57	8.17	9.52	

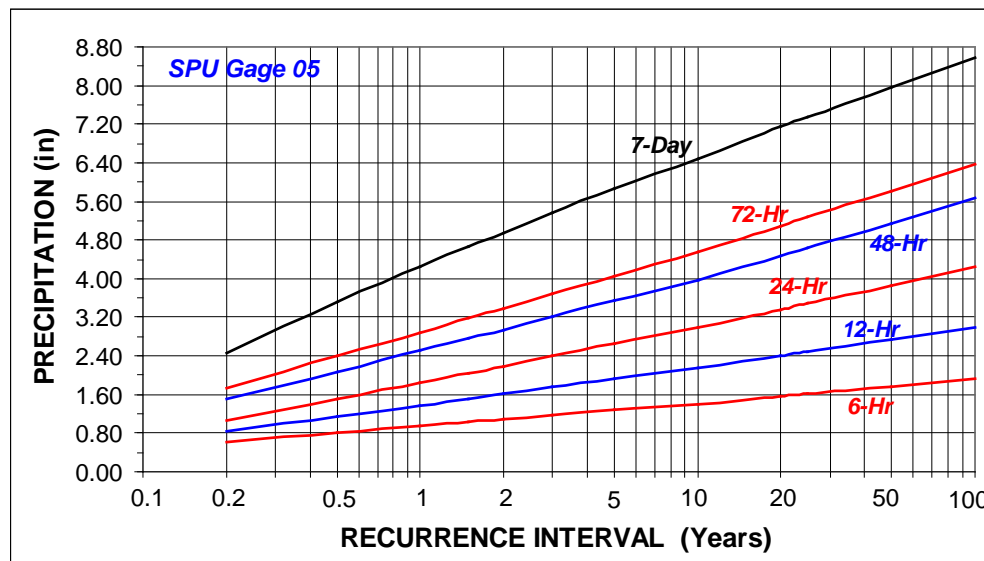

Figure 7. Precipitation-Magnitude-Frequency Estimates for SPU Gauge 05.

Table 10. Precipitation-Magnitude-Frequency Estimates for SPU Gauge 07.

Duration (hr)	Precipitation (in)										
	Recurrence Interval (years)										
		0.5-Yr	1-Yr	2-Yr	5-Yr	10-Yr		25-Yr	50-Yr	100-Yr	500-Yr
6		0.77	0.91	1.06	1.26	1.40		1.62	1.78	1.95	2.36
12		1.08	1.30	1.53	1.83	2.05		2.38	2.64	2.89	3.50
24		1.44	1.75	2.07	2.51	2.83		3.31	3.68	4.06	4.97
48		1.73	2.12	2.53	3.08	3.49		4.09	4.56	5.03	6.18
72		2.13	2.59	3.06	3.69	4.13		4.80	5.30	5.79	6.97
168		3.03	3.69	4.34	5.17	5.75		6.57	7.16	7.74	9.01

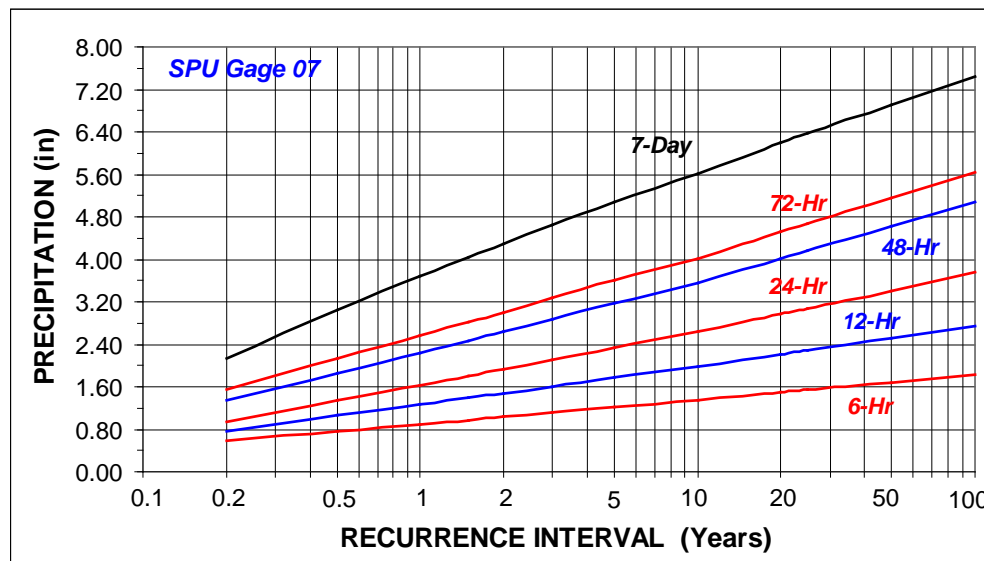

Figure 8. Precipitation-Magnitude-Frequency Estimates for SPU Gauge 07.

Table 11. Precipitation-Magnitude-Frequency Estimates for SPU Gauge 08.

Duration (hr)	Precipitation (in)										
	Recurrence Interval (years)										
		0.5-Yr	1-Yr	2-Yr	5-Yr	10-Yr		25-Yr	50-Yr	100-Yr	500-Yr
6		0.78	0.92	1.07	1.27	1.41		1.63	1.80	1.97	2.38
12		1.09	1.31	1.54	1.85	2.07		2.41	2.66	2.92	3.53
24		1.45	1.76	2.09	2.53	2.86		3.34	3.72	4.10	5.01
48		1.75	2.15	2.56	3.12	3.53		4.14	4.61	5.09	6.25
72		2.15	2.62	3.09	3.73	4.18		4.85	5.36	5.86	7.05
168		3.07	3.74	4.40	5.24	5.82		6.65	7.25	7.83	9.12

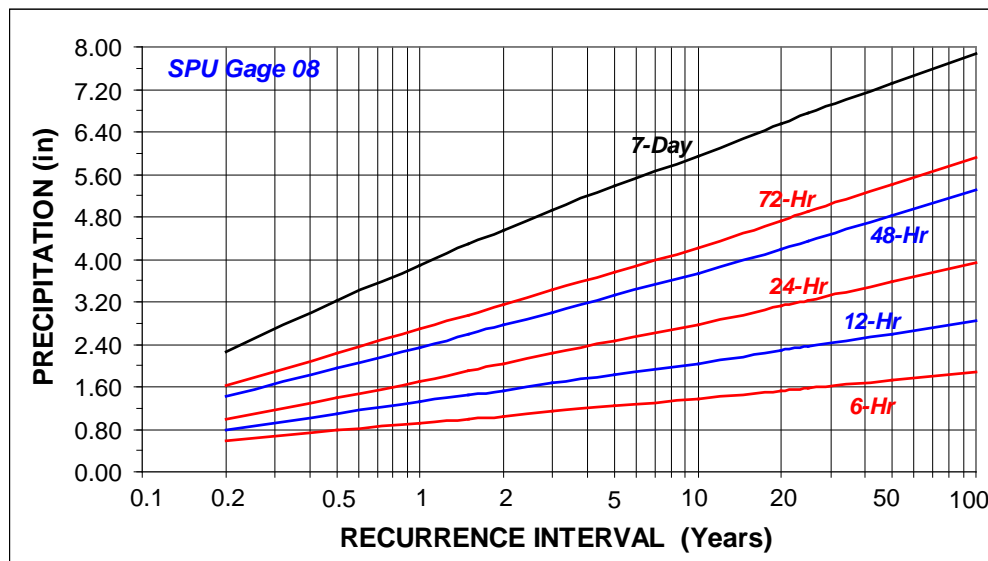

Figure 9. Precipitation-Magnitude-Frequency Estimates for SPU Gauge 08.

Table 12. Precipitation-Magnitude-Frequency Estimates for SPU Gauge 09.

Duration (hr)	Precipitation (in)										
	Recurrence Interval (years)										
		0.5-Yr	1-Yr	2-Yr	5-Yr	10-Yr		25-Yr	50-Yr	100-Yr	500-Yr
6		0.77	0.91	1.06	1.26	1.41		1.62	1.79	1.96	2.37
12		1.09	1.31	1.53	1.84	2.06		2.39	2.65	2.90	3.52
24		1.44	1.75	2.08	2.52	2.84		3.33	3.70	4.08	4.99
48		1.74	2.14	2.55	3.10	3.51		4.12	4.59	5.06	6.22
72		2.14	2.60	3.08	3.71	4.16		4.83	5.33	5.83	7.01
168		3.05	3.71	4.37	5.21	5.79		6.61	7.21	7.78	9.07

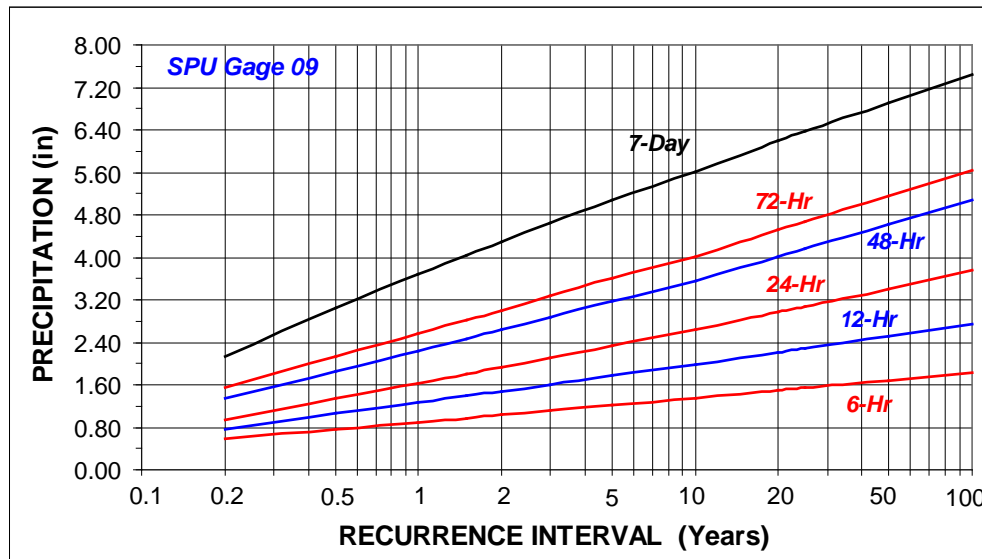

Figure 10. Precipitation-Magnitude-Frequency Estimates for SPU Gauge 09.

Table 13. Precipitation-Magnitude-Frequency Estimates for SPU Gauge 10.

Duration (hr)	Precipitation (in)										
	Recurrence Interval (years)										
		0.5-Yr	1-Yr	2-Yr	5-Yr	10-Yr		25-Yr	50-Yr	100-Yr	500-Yr
6		0.81	0.96	1.12	1.33	1.48		1.71	1.89	2.07	2.50
12		1.16	1.39	1.63	1.96	2.20		2.55	2.82	3.09	3.74
24		1.54	1.87	2.22	2.69	3.04		3.55	3.95	4.36	5.33
48		1.88	2.30	2.75	3.35	3.78		4.44	4.95	5.46	6.71
72		2.31	2.81	3.33	4.01	4.50		5.22	5.76	6.30	7.58
168		3.32	4.04	4.75	5.66	6.29		7.19	7.84	8.46	9.86

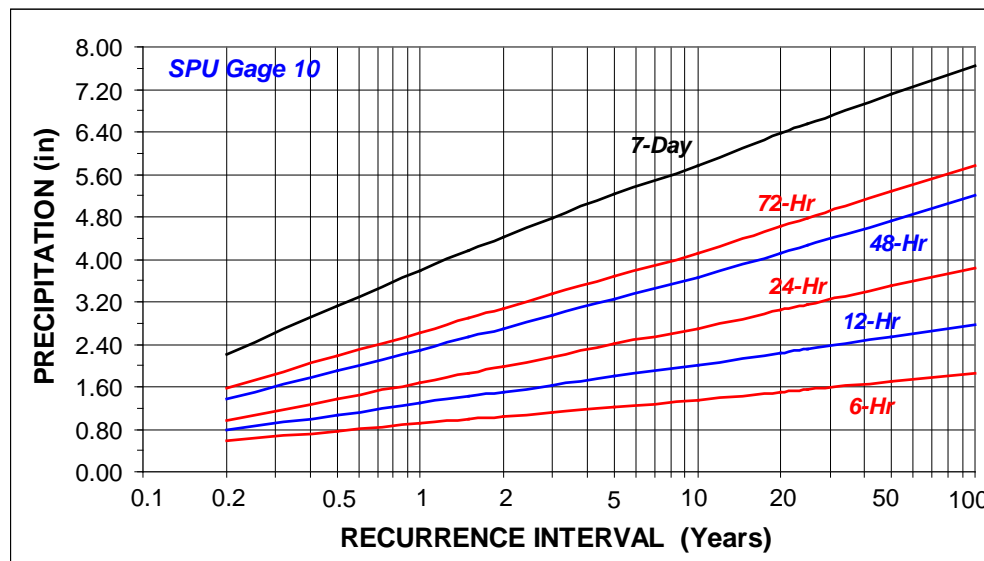

Figure 11. Precipitation-Magnitude-Frequency Estimates for SPU Gauge 10.

Table 14. Precipitation-Magnitude-Frequency Estimates for SPU Gauge 11.

Duration (hr)	Precipitation (in)										
	Recurrence Interval (years)										
		0.5-Yr	1-Yr	2-Yr	5-Yr	10-Yr		25-Yr	50-Yr	100-Yr	500-Yr
6		0.78	0.92	1.07	1.27	1.42		1.64	1.80	1.98	2.39
12		1.10	1.32	1.55	1.86	2.08		2.42	2.67	2.93	3.55
24		1.46	1.77	2.10	2.55	2.87		3.36	3.73	4.12	5.04
48		1.76	2.16	2.57	3.14	3.55		4.16	4.64	5.12	6.29
72		2.16	2.63	3.11	3.75	4.21		4.88	5.39	5.90	7.09
168		3.09	3.76	4.42	5.27	5.86		6.70	7.30	7.88	9.18

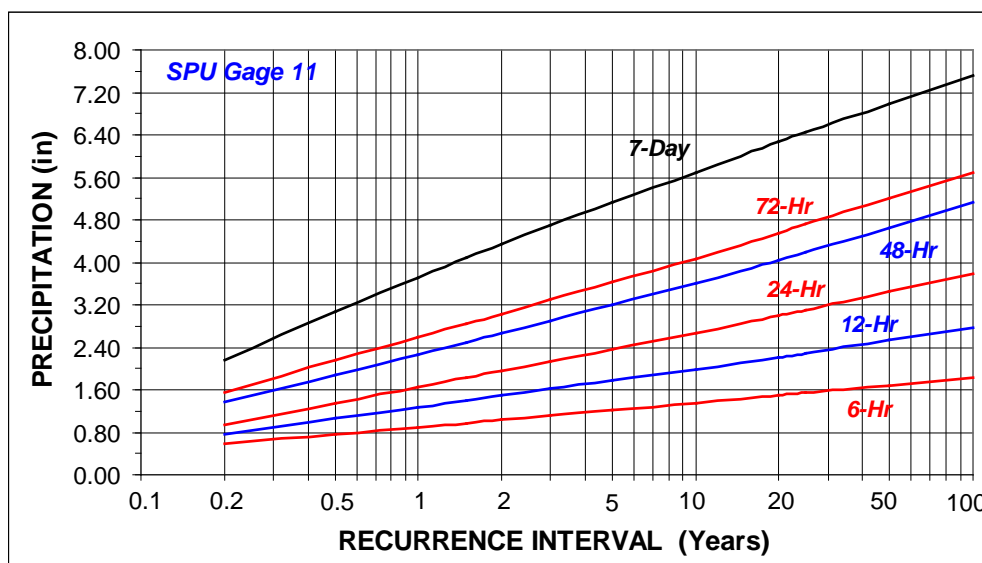

Figure 12. Precipitation-Magnitude-Frequency Estimates for SPU Gauge 11.

Table 15. Precipitation-Magnitude-Frequency Estimates for SPU Gauge 12.

Duration (hr)	Precipitation (in)										
	Recurrence Interval (years)										
		0.5-Yr	1-Yr	2-Yr	5-Yr	10-Yr		25-Yr	50-Yr	100-Yr	500-Yr
6		0.78	0.92	1.07	1.27	1.41		1.63	1.80	1.97	2.38
12		1.09	1.31	1.54	1.85	2.07		2.41	2.66	2.92	3.53
24		1.45	1.76	2.09	2.53	2.86		3.34	3.72	4.10	5.01
48		1.75	2.15	2.56	3.12	3.53		4.14	4.61	5.09	6.25
72		2.15	2.62	3.09	3.73	4.18		4.85	5.36	5.86	7.05
168		3.07	3.74	4.40	5.24	5.82		6.65	7.25	7.83	9.12

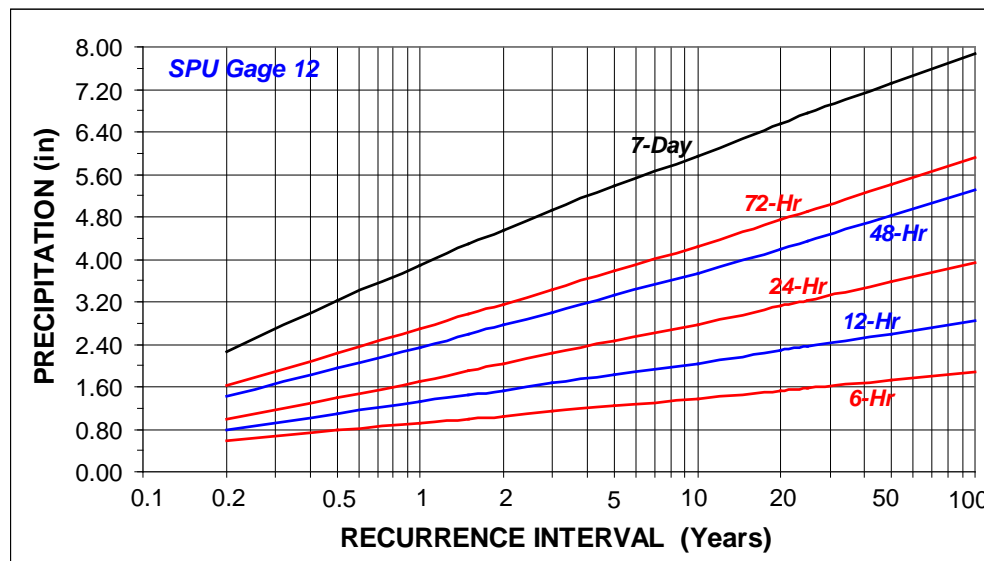

Figure 13. Precipitation-Magnitude-Frequency Estimates for SPU Gauge 12.

Table 16. Precipitation-Magnitude-Frequency Estimates for SPU Gauge 14.

Duration (hr)	Precipitation (in)										
	Recurrence Interval (years)										
		0.5-Yr	1-Yr	2-Yr	5-Yr	10-Yr		25-Yr	50-Yr	100-Yr	500-Yr
6		0.79	0.93	1.09	1.29	1.44		1.66	1.83	2.01	2.43
12		1.12	1.34	1.58	1.89	2.12		2.46	2.72	2.99	3.61
24		1.49	1.81	2.14	2.60	2.93		3.43	3.81	4.20	5.14
48		1.80	2.21	2.63	3.21	3.62		4.26	4.74	5.23	6.43
72		2.21	2.69	3.18	3.84	4.30		4.99	5.51	6.03	7.25
168		3.17	3.85	4.53	5.40	6.00		6.86	7.48	8.08	9.41

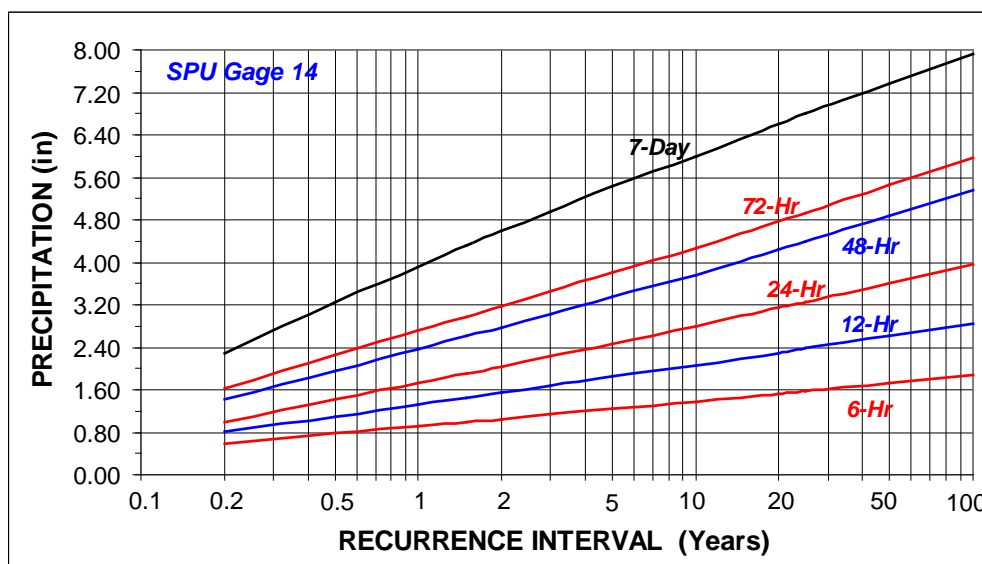

Figure 14. Precipitation-Magnitude-Frequency Estimates for SPU Gauge 14.

Table 17. Precipitation-Magnitude-Frequency Estimates for SPU Gauge 15.

Duration (hr)	Precipitation (in)										
	Recurrence Interval (years)										
		0.5-Yr	1-Yr	2-Yr	5-Yr	10-Yr		25-Yr	50-Yr	100-Yr	500-Yr
6		0.78	0.92	1.07	1.28	1.42		1.64	1.81	1.98	2.40
12		1.10	1.32	1.56	1.87	2.09		2.43	2.69	2.95	3.56
24		1.46	1.78	2.11	2.56	2.88		3.38	3.75	4.14	5.06
48		1.77	2.17	2.59	3.15	3.57		4.19	4.66	5.15	6.32
72		2.18	2.65	3.13	3.77	4.23		4.91	5.42	5.93	7.13
168		3.11	3.78	4.45	5.30	5.90		6.74	7.34	7.93	9.24

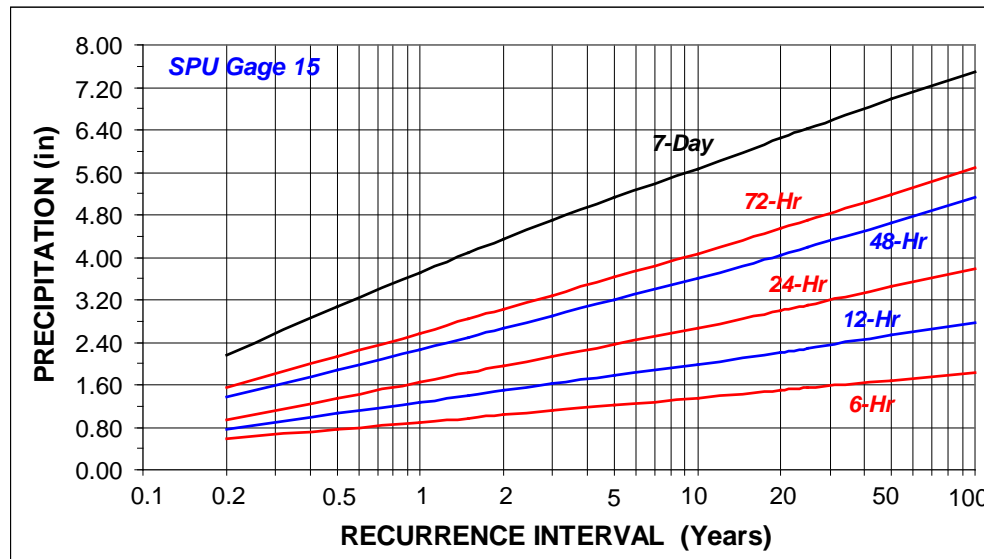

Figure 15. Precipitation-Magnitude-Frequency Estimates for SPU Gauge 15.

Table 18. Precipitation-Magnitude-Frequency Estimates for SPU Gauge 16.

Duration (hr)	Precipitation (in)										
	Recurrence Interval (years)										
		0.5-Yr	1-Yr	2-Yr	5-Yr	10-Yr		25-Yr	50-Yr	100-Yr	500-Yr
6		0.79	0.93	1.08	1.29	1.43		1.65	1.82	2.00	2.42
12		1.11	1.34	1.57	1.88	2.11		2.45	2.71	2.97	3.60
24		1.48	1.80	2.13	2.59	2.91		3.41	3.79	4.18	5.12
48		1.79	2.20	2.62	3.19	3.60		4.23	4.72	5.21	6.39
72		2.20	2.68	3.17	3.82	4.28		4.97	5.48	6.00	7.21
168		3.15	3.83	4.51	5.37	5.97		6.82	7.43	8.03	9.35

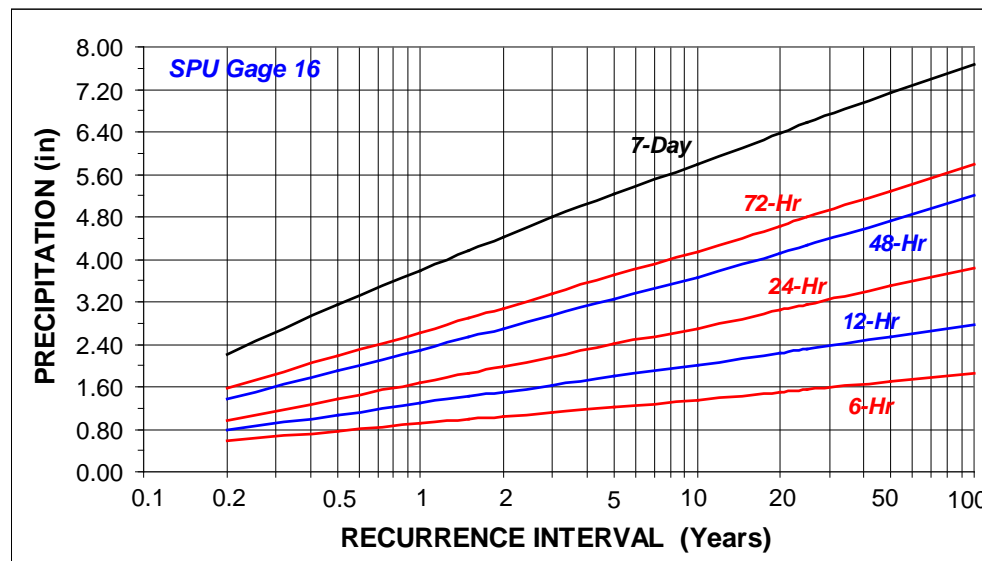

Figure 16. Precipitation-Magnitude-Frequency Estimates for SPU Gauge 16.

Table 19. Precipitation-Magnitude-Frequency Estimates for SPU Gauge 17.

Duration (hr)	Precipitation (in)										
	Recurrence Interval (years)										
		0.5-Yr	1-Yr	2-Yr	5-Yr	10-Yr		25-Yr	50-Yr	100-Yr	500-Yr
6		0.81	0.96	1.12	1.33	1.48		1.71	1.89	2.07	2.50
12		1.16	1.39	1.63	1.96	2.20		2.55	2.82	3.09	3.74
24		1.54	1.87	2.22	2.69	3.04		3.55	3.95	4.36	5.33
48		1.88	2.30	2.75	3.35	3.78		4.44	4.95	5.46	6.71
72		2.31	2.81	3.33	4.01	4.50		5.22	5.76	6.30	7.58
168		3.32	4.04	4.75	5.66	6.29		7.19	7.84	8.46	9.86

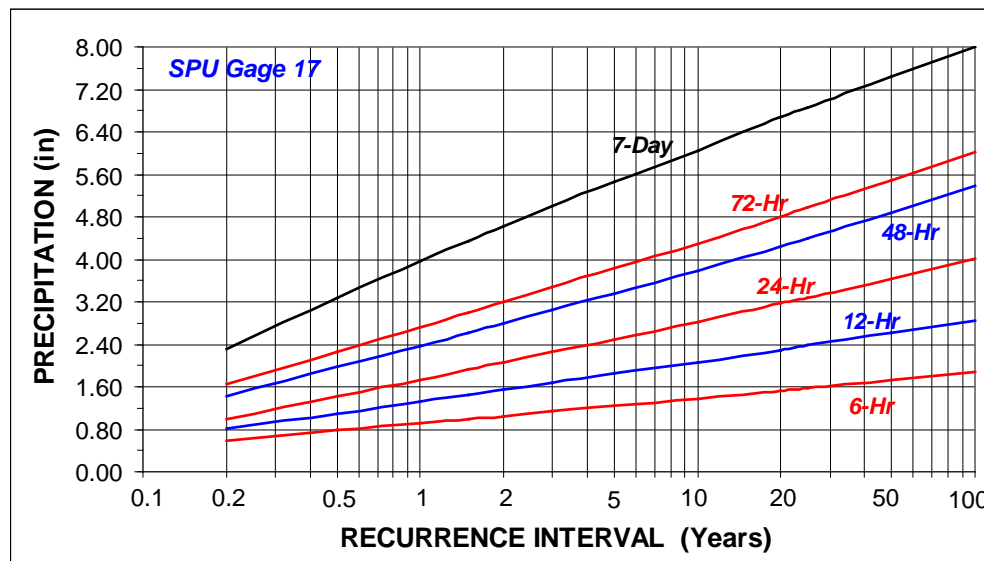

Figure 17. Precipitation-Magnitude-Frequency Estimates for SPU Gauge 17.

Table 20. Precipitation-Magnitude-Frequency Estimates for SPU Gauge 18.

Duration (hr)	Precipitation (in)										
	Recurrence Interval (years)										
		0.5-Yr	1-Yr	2-Yr	5-Yr	10-Yr		25-Yr	50-Yr	100-Yr	500-Yr
6		0.79	0.93	1.08	1.28	1.43		1.65	1.82	1.99	2.41
12		1.11	1.33	1.56	1.87	2.10		2.44	2.70	2.96	3.58
24		1.47	1.79	2.12	2.57	2.90		3.39	3.77	4.16	5.09
48		1.78	2.18	2.60	3.17	3.59		4.21	4.69	5.18	6.36
72		2.19	2.66	3.15	3.79	4.26		4.94	5.45	5.96	7.17
168		3.13	3.81	4.48	5.34	5.93		6.78	7.39	7.98	9.29

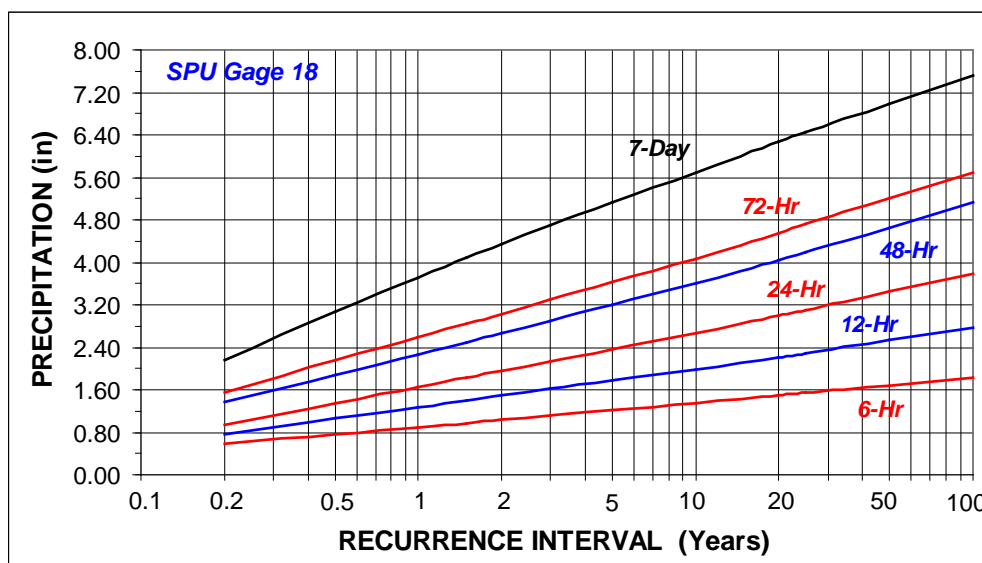

Figure 18. Precipitation-Magnitude-Frequency Estimates for SPU Gauge 18.

Table 21. Precipitation-Magnitude-Frequency Estimates for SPU Gauge 25.

Duration (hr)	Precipitation (in)										
	Recurrence Interval (years)										
	0.5-Yr	1-Yr	2-Yr	5-Yr	10-Yr	25-Yr	50-Yr	100-Yr	500-Yr		
6	0.79	0.93	1.08	1.28	1.43	1.65	1.82	1.99	2.41		
12	1.11	1.33	1.56	1.87	2.10	2.44	2.70	2.96	3.58		
24	1.47	1.79	2.12	2.57	2.90	3.39	3.77	4.16	5.09		
48	1.78	2.18	2.60	3.17	3.59	4.21	4.69	5.18	6.36		
72	2.19	2.66	3.15	3.79	4.26	4.94	5.45	5.96	7.17		
168	3.13	3.81	4.48	5.34	5.93	6.78	7.39	7.98	9.29		

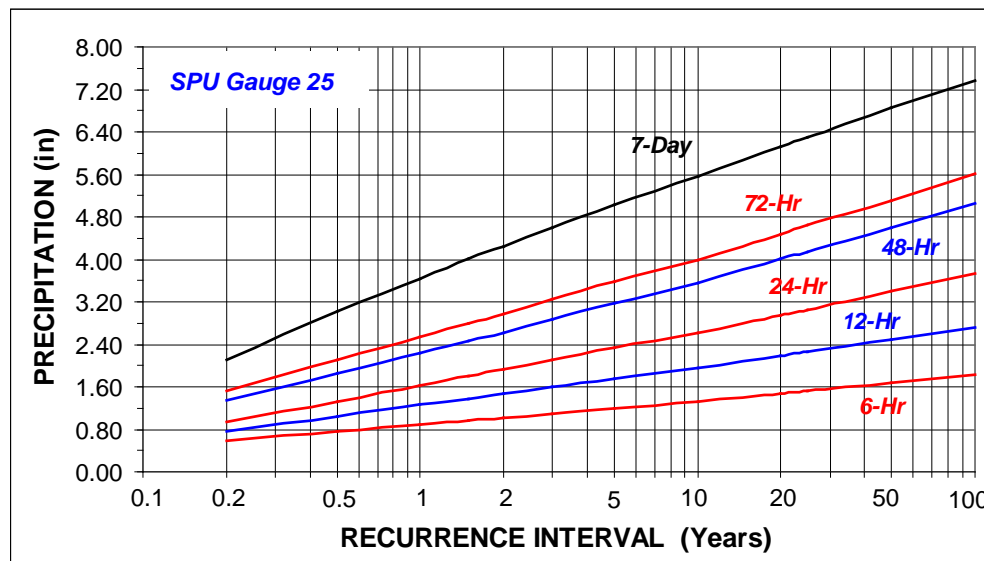

Figure 19. Precipitation-Magnitude-Frequency Estimates for SPU Gauge 25.

Table 22. Precipitation-Magnitude-Frequency Estimates for SeaTac.

Duration (hr)	Precipitation (in)										
	Recurrence Interval (years)										
		0.5-Yr	1-Yr	2-Yr	5-Yr	10-Yr		25-Yr	50-Yr	100-Yr	500-Yr
6		0.82	0.97	1.13	1.34	1.50		1.73	1.91	2.09	2.52
12		1.17	1.41	1.65	1.98	2.22		2.58	2.85	3.13	3.79
24		1.56	1.90	2.25	2.73	3.08		3.60	4.01	4.42	5.41
48		1.91	2.34	2.78	3.39	3.84		4.50	5.02	5.54	6.80
72		2.35	2.86	3.38	4.07	4.57		5.30	5.85	6.40	7.70
168		3.37	4.10	4.83	5.76	6.40		7.31	7.97	8.61	10.02

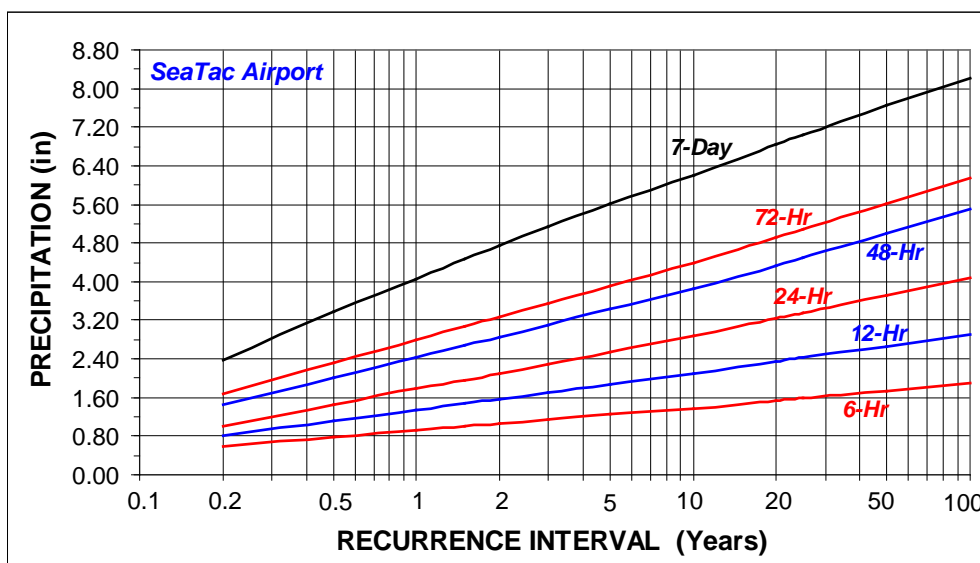

Figure 20. Precipitation-Magnitude-Frequency Estimates for SeaTac.

APPENDIX G

Stormwater Control Operations and Maintenance Requirements

This Cover to be Replaced in PDF
with SPU-Provided Cover

Note:

Some pages in this document have been purposely skipped or blank pages inserted so that this document will copy correctly when duplexed.

This appendix contains the maintenance requirements for the following typical stormwater [BMPs](#) facilities and components:

No. 1 - Detention Ponds	2
No. 2 - Infiltration BMPs	5
No. 3 - Detention Pipes and Vaults	11
No. 4 - Flow Control Structure & Control Device.....	14
No. 5 - Catch Basins and Maintenance Holes.....	19
No. 6 - Reserved	23
No. 7 - Debris Barriers (e.g., Trash Racks)	24
No. 8 - Energy Dissipaters.....	25
No. 9 - Basic and Compost-Amended Biofiltration Swales	28
No. 10 - Wet and Continuous Inflow Biofiltration Swales	30
No. 11 - Filter Strips (Basic and CAVFS)	32
No. 12 - Wet Ponds	34
No. 13 - Wet Vaults	38
No. 14 - Stormwater Treatment Wetlands	41
No. 15 - Sand Filter Basins	45
No. 16 - Sand Filter Vaults	49
No. 17 - Proprietary Technology Filter Cartridge Systems (example: BayFilter, FloGard PerkFilter, StormFilter)	53
No. 18 - API Oil/Water Separators.....	57
No. 19 - Coalescing Plate Oil/Water Separators.....	60
No. 20 - Catch Basin Filter Socks	63
No. 21 - Proprietary Technology Filterra System.....	64
No. 22 - Proprietary Technology Modular Wetland System	66
No. 23 - Bioretention Facilities	69
No. 24 - Cisterns	76
No. 25 - Downspout, Sheet Flow, and Concentrated Dispersion Systems	77
No. 26 - Permeable Pavement ¹	81
No. 27 - Trees.....	84
No. 28 - Vegetated Roof Systems	85
No. 29 - Rain Gardens	89

Refer to the *Stormwater Management Manual for Western Washington* (SWMMWW) (Ecology [20192012](#)) for maintenance requirements for the following BMP:

- Media filter drain (MFD)

All stormwater facilities, [Best Management Practices](#) (BMPs), and drainage systems shall be kept in continuous working order consistent with their design and permitting. [All stormwater facilities, BMPs, and drainage systems shall be kept accessible for maintenance and inspection at all times.](#)

Any evidence of contaminants or pollution such as oil, gasoline, concrete slurries, or paint shall be immediately corrected. This includes removing the source of the contamination as well as any contaminants that have been collected or deposited into the facility or conveyance system.

Training/written guidance is required for the proper operation and maintenance of many of the BMPs contained in this manual. Provide proper training and copies of the Operations and Maintenance Manuals to property owners, tenants and responsible individuals.

No. 1 - Detention Ponds				
Maintenance Component	<u>Recommended Inspection Frequency</u> ¹	Defect or Problem	Conditions When Maintenance Is Needed	Results Expected When Maintenance Is Performed
Facility – General Requirements	<u>A</u>	Trash and debris	Any trash and debris which exceed 1 cubic foot per 1,000 square feet (this is about equal to the amount of trash it would take to fill up one standard size office garbage can)	Trash and debris cleared from site
	<u>M (March – October)</u>	Noxious weeds	Any noxious or nuisance vegetation which may constitute a hazard to City personnel or the public	<ul style="list-style-type: none"> • Noxious and nuisance vegetation removed according to applicable regulations • No danger of noxious vegetation where City personnel or the public might normally be
	<u>A, E</u>	Contaminants and pollution	Any evidence of contaminants or pollution such as oil, gasoline, concrete slurries, or paint	<ul style="list-style-type: none"> • Materials removed and disposed of according to applicable regulations • Source control BMPs implemented if appropriate • No contaminants present other than a surface oil film
Top or Side Slopes of Dam, Berm or Embankment	<u>A</u>	Rodent holes	Any evidence of rodent holes if facility is acting as a dam or berm, or any evidence of water piping through dam or berm via rodent holes	Rodents removed or destroyed and dam or berm repaired
	<u>A</u>	Beaver dams	Dam results in change or function of the facility	Facility is returned to design function (coordinate trapping of beavers and removal of dams with appropriate permitting agencies)

No. 1 - Detention Ponds				
Maintenance Component	Recommended Inspection Frequency¹	Defect or Problem	Conditions When Maintenance Is Needed	Results Expected When Maintenance Is Performed
Top or Side Slopes of Dam, Berm or Embankment (continued)	A	Tree growth	<ul style="list-style-type: none"> • Tree growth threatens integrity of dams, berms, or slopes; does not allow maintenance access; or interferes with maintenance activity. • If trees are not a threat to dam, berm, or embankment integrity or not interfering with access or maintenance, they do not need to be removed. 	Trees do not hinder facility performance or maintenance activities
	A	Erosion	<ul style="list-style-type: none"> • Eroded damage over 2 inches deep where cause of damage is still present or where there is potential for continued erosion • Any erosion observed on a compacted slope 	Slopes stabilized using appropriate erosion control measures If erosion is occurring on compacted slope, a licensed engineer should be consulted to resolve source of erosion.
	A	Settlement	Any part of a dam, berm or embankment that has settled 4 inches lower than the design elevation	Top or side slope restored to design dimensions If settlement is significant, a licensed engineer should be consulted to determine the cause of the settlement.
Storage Area	A	Sediment accumulation	Accumulated sediment that exceeds 10 percent of the designed pond depth	<ul style="list-style-type: none"> • Sediment cleaned out to designed pond shape and depth • Pond reseeded if necessary to control erosion

No. 1 - Detention Ponds				
Maintenance Component	Recommended Inspection Frequency ¹	Defect or Problem	Conditions When Maintenance Is Needed	Results Expected When Maintenance Is Performed
Storage Area (continued)	A	Liner damaged (if applicable)	Liner is visible or pond does not hold water as designed	Liner repaired or replaced
Inlet/Outlet Pipe	A	Sediment accumulation	Sediment filling 1/3 or more of the pipe	Inlet/outlet pipes clear of sediment
	B, W, E	Trash and debris	Trash and debris accumulated in inlet/outlet pipes (includes floatables and non-floatables)	No trash or debris in pipes
	A	Damaged	<ul style="list-style-type: none"> Cracks wider than ½ inch at the joint of the inlet/outlet pipes Any evidence of soil entering at the joints of the inlet/outlet pipes 	No cracks more than ¼-inch wide at the joint of the inlet/outlet pipe
Emergency Overflow/Spillway	A	Tree growth	Tree growth impedes flow or threatens stability of spillway	Trees removed
	A	Rock missing	Only one layer of rock exists above native soil in area 5 square feet or larger or any exposure of native soil on the spillway	Spillway restored to design standards

¹ [Inspection frequency:](#)

[A = Annually; B = Biannually; M = Monthly; E = Recommend that additional inspections be performed as appropriate after major events \(e.g., >1 inch of precipitation in 24 hours or environmental incident that causes contaminant release; Q = Quarterly \(four times per year\); W = Recommend that at least one inspection occur during the wet season, preferably after trees have lost their leaves](#)

No. 2 - Infiltration <u>BMPs</u>Facilities				
Maintenance Component	<u>Recommended Inspection Frequency</u>¹	Defect or Problem	Conditions When Maintenance Is Needed	Results Expected When Maintenance Is Performed
Facility – General Requirements	A, W	Trash and debris	Any trash and debris which exceed 1 cubic foot per 1,000 square feet (this is about equal to the amount of trash it would take to fill up one standard size office garbage can)	Trash and debris cleared from site
	M (March – October)	Noxious weeds	Any noxious or nuisance vegetation which may constitute a hazard to City personnel or the public	<ul style="list-style-type: none"> • Noxious and nuisance vegetation removed according to applicable regulations • No danger of noxious vegetation where City personnel or the public might normally be
	A, W, E	Contaminants and pollution	Any evidence of contaminants or pollution such as oil, gasoline, concrete slurries, or paint	<ul style="list-style-type: none"> • Materials removed and disposed of according to applicable regulations • Source control BMPs implemented if appropriate • No contaminants present other than a surface oil film
	A	Grass/groundcover	Grass or groundcover exceeds 18 inches in height	Grass or groundcover mowed to a height no greater than 6 inches
Infiltration Pond, Top or Side Slopes of Dam, Berm or Embankment	A	Rodent holes	Any evidence of rodent holes if facility is acting as a dam or berm, or any evidence of water piping through dam or berm via rodent holes	Rodents removed or destroyed and dam or berm repaired

No. 2 - Infiltration <u>BMPs</u> Facilities				
Maintenance Component	<u>Recommended Inspection Frequency</u>¹	Defect or Problem	Conditions When Maintenance Is Needed	Results Expected When Maintenance Is Performed
Infiltration Pond, Top or Side Slopes of Dam, Berm or Embankment (continued)	<u>A</u>	Tree growth	<ul style="list-style-type: none"> • Tree growth threatens integrity of dams, berms or slopes, does not allow maintenance access, or interferes with maintenance activity • If trees are not a threat to dam, berm, or embankment integrity or not interfering with access or maintenance, they do not need to be removed. 	Trees do not hinder facility performance or maintenance activities
	<u>A</u>	Erosion	<ul style="list-style-type: none"> • Eroded damage over 2 inches deep where cause of damage is still present or where there is potential for continued erosion • Any erosion observed on a compacted slope 	Slopes stabilized using appropriate erosion control measures If erosion is occurring on compacted slope, a licensed engineer should be consulted to resolve source of erosion.
	<u>A</u>	Settlement	Any part of a dam, berm or embankment that has settled 4 inches lower than the design elevation	Top or side slope restored to design dimensions If settlement is significant, a licensed engineer should be consulted to determine the cause of the settlement.
Infiltration Pond, Tank, Vault, Trench, or Small Basin Storage Area	<u>A</u>	Sediment accumulation	If 2 inches or more sediment is present or a percolation test indicates facility is working at or less than 90 percent of design	Facility infiltrates as designed

No. 2 - Infiltration <u>BMPs</u> Facilities				
Maintenance Component	<u>Recommended Inspection Frequency</u>¹	Defect or Problem	Conditions When Maintenance Is Needed	Results Expected When Maintenance Is Performed
Infiltration Pond, Tank, Vault, Trench, or Small Basin Storage Area (continued)	A	Liner damaged (If Applicable)	Liner is visible or pond does not hold water as designed	Liner repaired or replaced
Infiltration Tank Structure	A	Plugged air vent	Any blockage of the vent	Tank or vault freely vents
	A	Tank bent out of shape	Any part of tank/pipe is bent out of shape more than 10 percent of its design shape	Tank repaired or replaced to design
	A	Gaps between sections, damaged joints or cracks or tears in wall	<ul style="list-style-type: none"> • A gap wider than ½ inch at the joint of any tank sections • Any evidence of soil particles entering the tank at a joint or through a wall 	No water or soil entering tank through joints or walls
Infiltration Vault Structure	A	Damage to wall, frame, bottom, and/or top slab	<ul style="list-style-type: none"> • Cracks wider than ½ inch • Any evidence of soil entering the structure through cracks • Qualified inspection personnel determines that the vault is not structurally sound 	Vault is sealed and structurally sound
Inlet/Outlet Pipes	A	Sediment accumulation	Sediment filling 1/3 or more of the pipe	Inlet/outlet pipes clear of sediment
	B, W, E	Trash and debris	Trash and debris accumulated in inlet/outlet pipes (includes floatables and non-floatables)	No trash or debris in pipes

No. 2 - Infiltration <u>BMPs</u> Facilities				
Maintenance Component	<u>Recommended Inspection Frequency</u> ¹	Defect or Problem	Conditions When Maintenance Is Needed	Results Expected When Maintenance Is Performed
<u>Inlet/Outlet Pipes</u> (continued)	A	Damaged	<ul style="list-style-type: none"> Cracks wider than ½ inch at the joint of the inlet/outlet pipes Any evidence of soil entering at the joints of the inlet/outlet pipes 	No cracks more than ¼-inch wide at the joint of the inlet/outlet pipe
Access Maintenance Hole	A	Cover/lid not in place	<ul style="list-style-type: none"> Cover/lid is missing or only partially in place Any open maintenance hole requires immediate maintenance 	Maintenance hole access cover/lid in place and secure
	A	Locking mechanism not working	<ul style="list-style-type: none"> Mechanism cannot be opened by one maintenance person with proper tools Bolts cannot be seated Self-locking cover/lid does not work 	Mechanism opens with proper tools
	A	Cover/lid difficult to remove	One maintenance person cannot remove cover/lid after applying 80 lbs of lift	Cover/lid can be removed and reinstalled by one maintenance person
	A	Ladder rungs unsafe	Missing rungs, misalignment, rust, or cracks	Ladder meets design standards and allows maintenance person safe access
Large Access Doors/Plate	A	Damaged or difficult to open	Large access doors or plates cannot be opened/removed using normal equipment	Replace or repair access door so it can open as designed
	A	Gaps, does not cover completely	Large access doors not flat and/or access opening not completely covered	Doors close flat and covers access opening completely

No. 2 - Infiltration <u>BMPs</u> Facilities				
Maintenance Component	<u>Recommended Inspection Frequency</u> ¹	Defect or Problem	Conditions When Maintenance Is Needed	Results Expected When Maintenance Is Performed
Large Access Doors/Plate (continued)	<u>A</u>	Lifting rings missing, rusted	Lifting rings not capable of lifting weight of door or plate	Lifting rings sufficient to lift or remove door or plate
Infiltration Pond, Tank, Vault, Trench, or Small Basin Filter Bags	<u>A</u>	Plugged	Filter bag more than 1/2 full	Replace filter bag or redesign system
Infiltration Pond, Tank, Vault, Trench, or Small Basin Pre-Settling Ponds and Vaults	<u>A, W</u>	Sediment accumulation	6 inches or more of sediment has accumulated	Pre-settling occurs as designed
Infiltration Pond, Rock Filter	<u>A</u>	Plugged	High water level on upstream side of filter remains for extended period of time or little or no water flows through filter during heavy rain storms	Rock filter replaced; evaluate need for filter and remove if not necessary
Infiltration Pond Emergency Overflow Spillway	<u>A</u>	Rock missing	<ul style="list-style-type: none"> • Only one layer of rock exists above native soil in area 5 square feet or larger, or any exposure of native soil at the top of out flow path of spillway • Rip-rap on inside slopes need not be replaced 	Spillway restored to design standards
	<u>A</u>	Tree growth	Tree growth impedes flow or threatens stability of spillway	Trees removed

No. 2 - Infiltration BMPs Facilities				
Maintenance Component	Recommended Inspection Frequency ¹	Defect or Problem	Conditions When Maintenance Is Needed	Results Expected When Maintenance Is Performed
Drain Rock	A, W	Water ponding	<ul style="list-style-type: none"> • If water enters the facility from the surface, inspect to see if water is ponding at the surface during storm events • If buried drain rock, observe drawdown through observation/maintenance port or cleanout 	<ul style="list-style-type: none"> • Clear piping through facility when ponding occurs • Replace rock material/sand reservoirs as necessary • Tilling of subgrade below reservoir may be necessary (for trenches) prior to backfill

¹ [Inspection frequency:](#)

[A = Annually; B = Biannually; M = Monthly; E = Recommend that additional inspections be performed as appropriate after major events \(e.g., >1 inch of precipitation in 24 hours or environmental incident that causes contaminant release; Q = Quarterly \(four times per year\); W = Recommend that at least one inspection occur during the wet season, preferably after trees have lost their leaves](#)

No. 3 - Detention Pipes and Vaults				
Maintenance Component	<u>Recommended Inspection Frequency</u>¹	Defect or Problem	Conditions When Maintenance is Needed	Results Expected When Maintenance is Performed
Facility – General Requirements	A, E	Contaminants and pollution	Any evidence of contaminants or pollution such as oil, gasoline, concrete slurries, or paint	<ul style="list-style-type: none"> • Materials removed and disposed of according to applicable regulations • Source control BMPs implemented if appropriate • No contaminants present other than a surface oil film
Pipe or Vault Storage Area	A, B, W, E	Trash and debris	Any trash and debris accumulated in vault or pipe (includes floatables and non-floatables)	No trash or debris in vault or pipe
	A	Sediment accumulation	Accumulated sediment depth exceeds 10 percent of the diameter of the storage area for ½ length of storage vault or any point depth exceeds 15 percent of diameter	All sediment removed from storage area
Pipe or Vault Structure	A	Plugged air vent	Any blockage of the vent	Pipe or vault freely vents
	A	Pipe bent out of shape	Any part of vault/pipe is bent out of shape more than 10 percent of its design shape	Pipe or vault repaired or replaced to design
	A	Gaps between sections, damaged joints or cracks or tears in wall	<ul style="list-style-type: none"> • A gap wider than ½ inch at the joint of any pipe or vault sections • Any evidence of soil particles entering the pipe or vault at a joint or through a wall 	No water or soil entering pipe or vault through joints or walls

No. 3 - Detention Pipes and Vaults				
Maintenance Component	Recommended Inspection Frequency ¹	Defect or Problem	Conditions When Maintenance is Needed	Results Expected When Maintenance is Performed
Vault Structure	A	Damage to wall, frame, bottom, and/or top slab	<ul style="list-style-type: none"> Cracks wider than ½ inch Any evidence of soil entering the structure through cracks Qualified inspection personnel determines that the vault is not structurally sound 	Vault sealed and structurally sound
Inlet/Outlet Pipes	A	Sediment accumulation	Sediment filling 1/3 or more of the pipe	Inlet/outlet pipes clear of sediment
	B, W, E	Trash and debris	Trash and debris accumulated in inlet/outlet pipes (includes floatables and non-floatables)	No trash or debris in pipes
	A	Damaged	<ul style="list-style-type: none"> Cracks wider than ½ inch at the joint of the inlet/outlet pipes Any evidence of soil entering at the joints of the inlet/outlet pipes 	No cracks more than ¼-inch wide at the joint of the inlet/outlet pipe
Access Maintenance Hole	A	Cover/lid not in place	<ul style="list-style-type: none"> Cover/lid is missing or only partially in place Any open maintenance hole requires immediate maintenance 	Maintenance hole access cover/lid in place and secure
	A	Locking mechanism not working	<ul style="list-style-type: none"> Mechanism cannot be opened by one maintenance person with proper tools Bolts cannot be seated Self-locking cover/lid does not work 	Mechanism opens with proper tools

No. 3 - Detention Pipes and Vaults				
Maintenance Component	Recommended Inspection Frequency ¹	Defect or Problem	Conditions When Maintenance is Needed	Results Expected When Maintenance is Performed
Access Maintenance Hole (continued)	A	Cover/lid difficult to remove	One maintenance person cannot remove cover/lid after applying 80 lbs of lift	Cover/lid can be removed and reinstalled by one maintenance person
	A	Ladder rungs unsafe	Missing rungs, misalignment, rust, or cracks	Ladder meets design standards and allows maintenance person safe access
Large Access Doors/Plate	A	Damaged or difficult to open	Large access doors or plates cannot be opened/removed using normal equipment	Replace or repair access door so it can open as designed
	A	Gaps, does not cover completely	Large access doors not flat and/or access opening not completely covered	Doors close flat and covers access opening completely
	A	Lifting rings missing, rusted	Lifting rings not capable of lifting weight of door or plate	Lifting rings sufficient to lift or remove door or plate

¹ [Inspection frequency:](#)

[A = Annually; B = Biannually; M = Monthly; E = Recommend that additional inspections be performed as appropriate after major events \(e.g., >1 inch of precipitation in 24 hours or environmental incident that causes contaminant release; Q = Quarterly \(four times per year\); W = Recommend that at least one inspection occur during the wet season, preferably after trees have lost their leaves](#)

No. 4 - Flow Control Structure & Control Device				
Maintenance Component	Recommended Inspection Frequency ¹	Defect or Problem	Condition When Maintenance is Needed	Results Expected When Maintenance is Performed
The Flow Control Structure and Control Device shall conform with design criteria shown upon the approved plans or the design standards in place at the time of construction. This includes but is not limited to, orifice diameter(s), orifice elevation(s) overflow elevation. Reference Standard Plans No. 270, 271, and 272.				
Structure	A	Trash and debris	Trash or debris of more than ½ cubic foot which is located immediately in front of the structure opening or is blocking capacity of the structure by more than 10 percent	No trash or debris blocking or potentially blocking entrance to structure
			Trash or debris in the structure that exceeds 1/3 the depth from the bottom of basin to invert the lowest pipe into or out of the basin.	No trash or debris in the structure
			Deposits of garbage exceeding 1 cubic foot in volume	No condition present which would attract or support the breeding of insects or rodents
	A	Sediment	Sediment exceeds 60 percent of the depth from the bottom of the structure to the invert of the lowest pipe into or out of the structure or the bottom of the control device section or is within 6 inches of the invert of the lowest pipe into or out of the structure or the bottom of the control device section	Sump of structure contains no sediment

No. 4 - Flow Control Structure & Control Device				
Maintenance Component	Recommended Inspection Frequency ¹	Defect or Problem	Condition When Maintenance is Needed	Results Expected When Maintenance is Performed
Structure (continued)	A	Damage to frame and/or top slab	Corner of frame extends more than ¾ inch past curb face into the street (If applicable)	Frame is even with curb
			Top slab has holes larger than 2 square inches or cracks wider than ¼ inch	Top slab is free of holes and cracks
			Frame not sitting flush on top slab, i.e., separation of more than ¾ inch of the frame from the top slab	Frame is sitting flush on top slab
	A	Cracks in walls or bottom	<ul style="list-style-type: none"> Cracks wider than ½ inch and longer than 3 feet Any evidence of soil particles entering structure through cracks Maintenance person judges that structure is unsound 	Structure is sealed and structurally sound.
			<ul style="list-style-type: none"> Cracks wider than ½ inch and longer than 1 foot at the joint of any inlet/outlet pipe Any evidence of soil particles entering structure through cracks 	No cracks more than ¼-inch wide at the joint of inlet/outlet pipe
	A	Settlement/misalignment	Structure has settled more than 1 inch or has rotated more than 2 inches out of alignment	Basin replaced or repaired to design standards

No. 4 - Flow Control Structure & Control Device				
Maintenance Component	Recommended Inspection Frequency ¹	Defect or Problem	Condition When Maintenance is Needed	Results Expected When Maintenance is Performed
Structure (continued)	A	Damaged pipe joints	<ul style="list-style-type: none"> Cracks wider than ½ inch at the joint of the inlet/outlet pipes Any evidence of soil entering the structure at the joint of the inlet/outlet pipes 	No cracks more than ¼-inch wide at the joint of inlet/outlet pipes
	A, E	Contaminants and pollution	Any evidence of contaminants or pollution such as oil, gasoline, concrete slurries, or paint	<ul style="list-style-type: none"> Materials removed and disposed of according to applicable regulations Source control BMPs implemented if appropriate No contaminants present other than a surface oil film
	A	Ladder rungs missing or unsafe	Ladder is unsafe due to missing rungs, misalignment, rust, cracks, or sharp edges	Ladder meets design standards and allows maintenance person safe access.
Control Device	A	Damaged or missing	Riser section is not securely attached to structure wall and outlet pipe structure should support at least 1,000 lbs of up or down pressure	T section securely attached to wall and outlet pipe
			Structure is not in upright position (allow up to 10 percent from plumb)	Structure in correct position
			Connections to outlet pipe are not watertight or show signs of deteriorated grout	Connections to outlet pipe are water tight; structure repaired or replaced and works as designed
			Any holes—other than designed holes—in the structure	Structure has no holes other than designed holes

No. 4 - Flow Control Structure & Control Device				
Maintenance Component	Recommended Inspection Frequency¹	Defect or Problem	Condition When Maintenance is Needed	Results Expected When Maintenance is Performed
Shear Gate (if applicable)	A	Damaged or missing	Cleanout gate is missing	Replace cleanout gate
			Cleanout gate is not watertight	Gate is watertight and works as designed.
			Gate cannot be moved up and down by one maintenance person	Gate moves up and down easily and is watertight.
			Chain/rod leading to gate is missing or damaged.	Chain is in place and works as designed.
Orifice Plate	A	Damaged or missing	Control device is not working properly due to missing, out of place, or bent orifice plate.	Plate is in place and works as designed.
	A	Obstructions	Any trash, debris, sediment, or vegetation blocking the plate	Plate is free of all obstructions and works as designed
Overflow Pipe	A	Obstructions	Any trash or debris blocking (or having the potential of blocking) the overflow pipe	Pipe is free of all obstructions and works as designed
	A	Deformed or damaged lip	Lip of overflow pipe is bent or deformed	Overflow pipe does not allow overflow at an elevation lower than design
Inlet/Outlet Pipe	A	Sediment accumulation	Sediment filling 1/3 or more of the pipe	Inlet/outlet pipes clear of sediment
	B, W, E	Trash and debris	Trash and debris accumulated in inlet/outlet pipes (includes floatables and non-floatables).	No trash or debris in pipes
	A	Damaged	<ul style="list-style-type: none"> Cracks wider than ½ inch at the joint of the inlet/outlet pipes Any evidence of soil entering at the joints of the inlet/outlet pipes 	No cracks more than ¼-inch wide at the joint of the inlet/outlet pipe

No. 4 - Flow Control Structure & Control Device				
Maintenance Component	<u>Recommended Inspection Frequency</u> ¹	Defect or Problem	Condition When Maintenance is Needed	Results Expected When Maintenance is Performed
Metal Grates (If Applicable)	<u>A</u>	Unsafe grate opening	Grate with opening wider than 7/8 inch	Grate opening meets design standards
	<u>B, W, E</u>	Trash and debris	Trash and debris that is blocking more than 20 percent of grate surface	Grate free of trash and debris. footnote to guidelines for disposal
	<u>A</u>	Damaged or missing	Grate missing or broken member(s) of the grate	Grate is in place and meets design standards
Maintenance Hole Cover/Lid	<u>A</u>	Cover/lid not in place	<ul style="list-style-type: none"> Cover/lid is missing or only partially in place Any open structure requires urgent maintenance 	Cover/lid protects opening to structure
	<u>A</u>	Locking mechanism Not Working	<ul style="list-style-type: none"> Mechanism cannot be opened by one maintenance person with proper tools Bolts cannot be seated Self-locking cover/lid does not work 	Mechanism opens with proper tools
	<u>A</u>	Cover/lid difficult to Remove	One maintenance person cannot remove cover/lid after applying 80 lbs. of lift	Cover/lid can be removed and reinstalled by one maintenance person

¹ Inspection frequency:

A = Annually; B = Biannually; M = Monthly; E = Recommend that additional inspections be performed as appropriate after major events (e.g., >1 inch of precipitation in 24 hours or environmental incident that causes contaminant release; Q = Quarterly (four times per year); W = Recommend that at least one inspection occur during the wet season, preferably after trees have lost their leaves

No. 5 - Catch Basins and Maintenance Holes				
Maintenance Component	Recommended Inspection Frequency ¹	Defect or Problem	Condition When Maintenance is Needed	Results Expected When Maintenance is Performed
Structure	A	Sediment	Sediment exceeds 60 percent of the depth from the bottom of the catch basin to the invert of the lowest pipe into or out of the catch basin or is within 6 inches of the invert of the lowest pipe into or out of the catch basin	Sump of catch basin contains no sediment
	B, W, E	Trash and debris	Trash or debris of more than ½ cubic foot which is located immediately in front of the catch basin opening or is blocking capacity of the catch basin by more than 10 percent	No trash or debris blocking or potentially blocking entrance to catch basin
	A		Trash or debris in the catch basin that exceeds 1/3 the depth from the bottom of basin to invert the lowest pipe into or out of the basin	No trash or debris in the catch basin
	A		Dead animals or vegetation that could generate odors that could cause complaints or dangerous gases (e.g., methane)	No dead animals or vegetation present within catch basin
	A		Deposits of garbage exceeding 1 cubic foot in volume	No condition present which would attract or support the breeding of insects or rodents

No. 5 - Catch Basins and Maintenance Holes				
Maintenance Component	Recommended Inspection Frequency ¹	Defect or Problem	Condition When Maintenance is Needed	Results Expected When Maintenance is Performed
Structure (continued)	A	Damage to frame and/or top slab	Corner of frame extends more than ¾ inch past curb face into the street (If applicable).	Frame is even with curb
			Top slab has holes larger than 2 square inches or cracks wider than ¼ inch.	Top slab is free of holes and cracks.
			Frame not sitting flush on top slab, i.e., separation of more than ¾ inch of the frame from the top slab	Frame is sitting flush on top slab.
	A	Cracks in walls or bottom	<ul style="list-style-type: none"> Cracks wider than ½ inch and longer than 3 feet Any evidence of soil particles entering catch basin through cracks Maintenance person judges that catch basin is unsound 	Catch basin is sealed and structurally sound
			<ul style="list-style-type: none"> Cracks wider than ½ inch and longer than 1 foot at the joint of any inlet/outlet pipe Any evidence of soil particles entering catch basin through cracks 	No cracks more than ¼-inch wide at the joint of inlet/outlet pipe
	A	Settlement/ misalignment	Catch basin has settled more than 1 inch or has rotated more than 2 inches out of alignment	Basin replaced or repaired to design standards

No. 5 - Catch Basins and Maintenance Holes				
Maintenance Component	Recommended Inspection Frequency ¹	Defect or Problem	Condition When Maintenance is Needed	Results Expected When Maintenance is Performed
Structure (continued)	A	Damaged pipe joints	<ul style="list-style-type: none"> Cracks wider than ½ inch at the joint of the inlet/outlet pipes Any evidence of soil entering the catch basin at the joint of the inlet/outlet pipes 	No cracks more than ¼-inch wide at the joint of inlet/outlet pipes
	A, E	Contaminants and pollution	Any evidence of contaminants or pollution such as oil, gasoline, concrete slurries, or paint	<ul style="list-style-type: none"> Materials removed and disposed of according to applicable regulations Source control BMPs implemented if appropriate No contaminants present other than a surface oil film
Inlet/Outlet Pipe	A	Sediment accumulation	Sediment filling 1/3 or more of the pipe	Inlet/outlet pipes clear of sediment
	B, W, E	Trash and debris	Trash and debris accumulated in inlet/outlet pipes (includes floatables and non-floatables)	No trash or debris in pipes
	A	Damaged	<ul style="list-style-type: none"> Cracks wider than ½ inch at the joint of the inlet/outlet pipes Any evidence of soil entering at the joints of the inlet/outlet pipes 	No cracks more than ¼-inch wide at the joint of the inlet/outlet pipe
Catch Basin Outlet Trap (Reference Standard Plan No. 267)	A	Missing	When the required outlet trap is not installed upon the outlet pipe	Outlet trap installed and prevents floatables from being discharged
	A	Permanently installed	When the trap is grouted to the outlet pipe and is not removable to allow for maintenance and inspection	Outlet trap removable for maintenance and inspection

No. 5 - Catch Basins and Maintenance Holes				
Maintenance Component	Recommended Inspection Frequency¹	Defect or Problem	Condition When Maintenance is Needed	Results Expected When Maintenance is Performed
Catch Basin Outlet Trap (Reference Standard Plan No. 267) (continued)	A	Damaged	Cracks, broken welds, seams or any other conditions that allows water to be discharged from other than the submerged portion of the trap	Water will be discharged from the submerged portion of the trap.
Metal Grates (Catch Basins)	A	Unsafe grate opening	Grate with opening wider than 7/8 inch	Grate opening meets design standards
	B, W, E	Trash and debris	Trash and debris that is blocking more than 20 percent of grate surface	Grate free of trash and debris. footnote to guidelines for disposal
	A	Damaged or missing	<ul style="list-style-type: none"> Grate missing or broken member(s) of the grate Any open structure requires urgent maintenance 	Grate is in place and meets design standards
Maintenance Hole Cover/Lid	A	Cover/lid not in place	<ul style="list-style-type: none"> Cover/lid is missing or only partially in place Any open structure requires urgent maintenance 	Cover/lid protects opening to structure
	A	Locking mechanism Not Working	<ul style="list-style-type: none"> Mechanism cannot be opened by one maintenance person with proper tools Bolts cannot be seated Self-locking cover/lid does not work 	Mechanism opens with proper tools
	A	Cover/lid difficult to remove	One maintenance person cannot remove cover/lid after applying 80 lbs. of lift	Cover/lid can be removed and reinstalled by one maintenance person

¹ [Inspection frequency:](#)

[A = Annually; B = Biannually; M = Monthly; E = Recommend that additional inspections be performed as appropriate after major events \(e.g., >1 inch of precipitation in 24 hours or environmental incident that causes contaminant release; Q = Quarterly \(four times per year\); W = Recommend that at least one inspection occur during the wet season, preferably after trees have lost their leaves](#)

No. 7 - Debris Barriers (e.g., Trash Racks)				
Maintenance Component	Recommended Inspection Frequency¹	Defect or Problem	Condition When Maintenance is Needed	Results Expected When Maintenance is Performed
Facility – General Requirements	B, W, E	Trash and debris	Trash or debris plugging more than 20 percent of the area of the barrier	Barrier clear to receive capacity flow
	A	Sediment accumulation	Sediment accumulation of greater than 20 percent of the area of the barrier	Barrier clear to receive capacity flow
Structure	A	Cracked, broken, or loose	<ul style="list-style-type: none"> • Structure which bars attach to is damaged • Pipe is loose or cracked • Concrete structure is cracked, broken, or loose 	Sound structure barrier
Bars	A	Bar spacing	Bar spacing exceeds 6 inches	Bars have at most 6-inch spacing
	A	Damaged or missing bars	Bars bent out of shape more than 3 inches	Bars in place with no bends more than ¾ inch
			Bars missing or entire barrier missing	Bars in place according to design
			Bars loose and rust is causing 50 percent deterioration to any part of barrier	Repair or replace barrier to design standards

¹ [Inspection frequency:](#)

[A = Annually; B = Biannually; M = Monthly; E = Recommend that additional inspections be performed as appropriate after major events \(e.g., >1 inch of precipitation in 24 hours or environmental incident that causes contaminant release; Q = Quarterly \(four times per year\); W = Recommend that at least one inspection occur during the wet season, preferably after trees have lost their leaves](#)

No. 8 - Energy Dissipaters				
Maintenance Component	<u>Recommended Inspection Frequency</u>¹	Defect or Problem	Conditions When Maintenance is Needed	Results Expected When Maintenance is Performed
Facility – General Requirements	B, W, E	Trash and debris	Trash and/or debris accumulation	Dissipater clear of trash and/or debris
	A, E	Contaminants and pollution	Any evidence of contaminants or pollution such as oil, gasoline, concrete slurries, or paint	<ul style="list-style-type: none"> • Materials removed and disposed of according to applicable regulations • Source control BMPs implemented if appropriate • No contaminants present other than a surface oil film
Rock Pad	A	Missing or moved rock	<ul style="list-style-type: none"> • One layer or less of rock exists above native soil area 5 square feet or more • Any exposed native soil 	Rock pad prevents erosion
Dispersion Trench	A	Pipe plugged with sediment	Accumulated sediment that exceeds 20 percent of the design depth	Pipe cleaned/flushed so that it matches design
	A	Not discharging water properly	Visual evidence of water discharging at concentrated points along trench (normal condition is a “sheet flow” of water along trench)	Water discharges from feature by sheet flow
	A	Perforations plugged	Over 1/4 of perforations in pipe are plugged with debris or sediment	Perforations freely discharge flow
	A	Water flows out top of “distributor” catch basin	Water flows out of distributor catch basin during any storm less than the design storm	No flow discharges from distributor catch basin
	A	Receiving area over-saturated	Water in receiving area is causing or has potential of causing landslide problems	No danger of landslides

No. 8 - Energy Dissipaters				
Maintenance Component	<u>Recommended Inspection Frequency</u>¹	Defect or Problem	Conditions When Maintenance is Needed	Results Expected When Maintenance is Performed
Gabions	A	Damaged mesh	Mesh of gabion broken, twisted or deformed so structure is weakened or rock may fall out	Mesh is intact with no rock missing
	A	Corrosion	Gabion mesh shows corrosion through more than ¼ of its gage	All gabion mesh capable of containing rock and retaining designed form
	A	Collapsed or deformed baskets	Gabion basket shape deformed due to any cause	All gabion baskets intact, structure stands as designed
	A	Missing rock	Any rock missing that could cause gabion to loose structural integrity	No rock missing
Maintenance Hole/Chamber	A	Worn or damaged post, baffles, or side of chamber	Structure dissipating flow deteriorates to ½ or original size or any concentrated worn spot exceeding 1 square foot, which would make structure unsound	Structure in no danger of failing
	A	Damage to wall, frame, bottom, and/or top slab	<ul style="list-style-type: none"> • Cracks wider than ½ inch • Any evidence of soil entering the structure through cracks • Maintenance inspection personnel determines that the structure is not structurally sound 	Maintenance hole/chamber sealed and structurally sound
	A	Damaged pipe joints	<ul style="list-style-type: none"> • Cracks wider than ½ inch at the joint of the inlet/outlet pipes • Any evidence of soil entering the structure at the joint of the inlet/outlet pipes 	<ul style="list-style-type: none"> • No soil or water enters • No water discharges at the joint of inlet/outlet pipes

¹ [Inspection frequency:](#)

A = Annually; B = Biannually; M = Monthly; E = Recommend that additional inspections be performed as appropriate after major events (e.g., >1 inch of precipitation in 24 hours or environmental incident that causes contaminant release; Q = Quarterly (four times per year); W = Recommend that at least one inspection occur during the wet season, preferably after trees have lost their leaves

No. 9 - Basic and Compost-Amended Biofiltration Swales				
Maintenance Component	Recommended Inspection Frequency ¹	Defect or Problem	Condition When Maintenance is Needed	Results Expected When Maintenance is Performed
Facility – General Requirements	M	Trash and debris	Trash and/or debris accumulation	No trash or debris at the site
	B, E	Contaminants and pollution	Any evidence of contaminants or pollution such as oil, gasoline, concrete slurries, or paint	<ul style="list-style-type: none"> Materials removed and disposed of according to applicable regulations Source control BMPs implemented if appropriate No contaminants present other than a surface oil film
Swale Section	B, E	Sediment accumulation	Sediment depth exceeds 2 inches in 10 percent of the swale treatment area	No sediment deposits in treatment area of the biofiltration swale
			Sediment inhibits grass growth over 10 percent of swale length	Grass growth not inhibited by sediment
			Sediment inhibits even spreading of flow	Flows are spread evenly over entire swale width
	B, E	Erosion/scouring	Eroded or scoured swale bottom due to channelization or high flows	<ul style="list-style-type: none"> No eroded or scoured areas in biofiltration swale Cause of erosion or scour addressed
	M	Poor vegetation coverage	Grass is sparse or bare or eroded patches occur in more than 10 percent of the swale bottom	<ul style="list-style-type: none"> Swale has no bare spots Grass is thick and healthy
	B	Grass too tall	<ul style="list-style-type: none"> Grass is excessively tall (greater than 10 inches) Grass is thin Nuisance weeds and other vegetation has taken over 	<ul style="list-style-type: none"> Grass between 3 and 4 inches tall, thick and healthy No clippings left in swale No nuisance vegetation present

No. 9 - Basic and Compost-Amended Biofiltration Swales				
Maintenance Component	Recommended Inspection Frequency ¹	Defect or Problem	Condition When Maintenance is Needed	Results Expected When Maintenance is Performed
Swale Section (continued)	B	Excessive shade	Grass growth is poor because sunlight does not reach swale	<ul style="list-style-type: none"> • Healthy grass growth or • Swale converted to a wet biofiltration swale
	B	Constant baseflow	<ul style="list-style-type: none"> • Continuous flow through the swale, even when it has been dry for weeks or an eroded • Muddy channel has formed in the swale bottom 	Baseflow removed from swale by a low-flow pea-gravel drain or bypassed around the swale
	B	Standing water	Water pools in the swale between storms or does not drain freely	Swale drains freely and no standing water in swale between storms
	B	Channelization	Flow concentrates and erodes channel through swale	No flow channels in swale
Flow Spreader	B	Concentrated flow	Flow from spreader not uniformly distributed across entire swale width	Flows are spread evenly over entire swale width
Inlet/Outlet Pipe	A	Sediment accumulation	Sediment filling 1/3 or more of the pipe	Inlet/outlet pipes clear of sediment
	B, W, E	Trash and debris	Trash and debris accumulated in inlet/outlet pipes (includes floatables and non-floatables)	No trash or debris in pipes
	A	Damaged	<ul style="list-style-type: none"> • Cracks wider than ½ inch at the joint of the inlet/outlet pipes • Any evidence of soil entering at the joints of the inlet/outlet pipes 	No cracks more than ¼-inch wide at the joint of the inlet/outlet pipe

¹ Inspection frequency:

A = Annually; B = Biannually; M = Monthly; E = Recommend that additional inspections be performed as appropriate after major events (e.g., >1 inch of precipitation in 24 hours or environmental incident that causes contaminant release; Q = Quarterly (four times per year); W = Recommend that at least one inspection occur during the wet season, preferably after trees have lost their leaves

No. 10 - Wet and Continuous Inflow Biofiltration Swales				
Maintenance Component	Recommended Inspection Frequency ¹	Defect or Problem	Condition When Maintenance is Needed	Results Expected When Maintenance Is Performed
Facility – General Requirements	M	Trash and debris	Any trash and/or debris accumulated at the site	No trash or debris at the site
	B, E	Contaminants and pollution	Any evidence of contaminants or pollution such as oil, gasoline, concrete slurries, or paint	<ul style="list-style-type: none"> Materials removed and disposed of according to applicable regulations Source control BMPs implemented if appropriate No contaminants present other than a surface oil film
Swale Section	B, E	Sediment accumulation	Sediment depth exceeds 2 inches in 10 percent of the swale treatment area	No sediment deposits in treatment area
	B, E	Erosion/scouring	Eroded or scoured swale bottom due to channelization or high flows	<ul style="list-style-type: none"> No eroded or scoured areas in biofiltration swale Cause of erosion or scour addressed
	B	Water depth	Water not retained to a depth of about 4 inches during the wet season	Water depth of 4 inches throughout swale for most of wet season
	B	Vegetation ineffective	<ul style="list-style-type: none"> Vegetation sparse; does not provide adequate filtration Vegetation crowded out by very dense clumps of cattail or nuisance vegetation 	<ul style="list-style-type: none"> Wetland vegetation fully covers bottom of swale No cattails or nuisance vegetation present
	B	Insufficient water	Wetland vegetation dies due to lack of water	Wetland vegetation remains healthy (may require converting to grass-lined biofiltration swale)
Flow Spreader	B	Concentrated flow	Flow from spreader not uniformly distributed across entire swale width	Flows are spread evenly over entire swale width

No. 10 - Wet and Continuous Inflow Biofiltration Swales				
Maintenance Component	<u>Recommended Inspection Frequency</u> ¹	Defect or Problem	Condition When Maintenance is Needed	Results Expected When Maintenance Is Performed
Inlet/Outlet Pipe	<u>A</u>	Sediment accumulation	Sediment filling 1/3 or more of the pipe	Inlet/outlet pipes clear of sediment
	<u>B, W, E</u>	Trash and debris	Trash and debris accumulated in inlet/outlet pipes (includes floatables and non-floatables)	No trash or debris in pipes
	<u>A</u>	Damaged	<ul style="list-style-type: none"> Cracks wider than ½ inch at the joint of the inlet/outlet pipes Any evidence of soil entering at the joints of the inlet/outlet pipes 	No cracks more than ¼-inch wide at the joint of the inlet/outlet pipe

¹ Inspection frequency:

A = Annually; B = Biannually; M = Monthly; E = Recommend that additional inspections be performed as appropriate after major events (e.g., >1 inch of precipitation in 24 hours or environmental incident that causes contaminant release; Q = Quarterly (four times per year); W = Recommend that at least one inspection occur during the wet season, preferably after trees have lost their leaves

No. 11 - Filter Strips (Basic and CAVFS)				
Maintenance Component	Recommended Inspection Frequency ¹	Defect or Problem	Condition When Maintenance is Needed	Results Expected When Maintenance Is Performed
Facility – General Requirements	<u>M</u>	Trash and debris	Any trash and/or debris accumulated at the site	No trash or debris at the site
	<u>B, E</u>	Contaminants and pollution	Any evidence of contaminants or pollution such as oil, gasoline, concrete slurries, or paint	<ul style="list-style-type: none"> Materials removed and disposed of according to applicable regulations Source control BMPs implemented if appropriate No contaminants present other than a surface oil film
Grass Strip	<u>B, E</u>	Sediment accumulation	Sediment accumulation exceeds 2 inches depth	No sediment deposits in treatment area
	<u>B, E</u>	Erosion/scouring	Eroded or scoured areas due to channelization or high flows	<ul style="list-style-type: none"> No eroded or scoured areas Cause of erosion or scour addressed
	<u>B</u>	Vegetation ineffective	<ul style="list-style-type: none"> Grass has died out Grass has become excessively tall (greater than 10 inches) Nuisance vegetation is taking over 	<ul style="list-style-type: none"> Grass is healthy; between 3 and 4 inches tall No nuisance vegetation present
Flow Spreader	<u>B</u>	Concentrated flow	Flow from spreader not uniformly distributed across entire filter width	Flows are spread evenly over entire filter width
Inlet/Outlet Pipe	<u>A</u>	Sediment accumulation	Sediment filling 1/3 or more of the pipe	Inlet/outlet pipes clear of sediment
	<u>B, W, E</u>	Trash and debris	Trash and debris accumulated in inlet/outlet pipes (includes floatables and non-floatables)	No trash or debris in pipes

No. 11 - Filter Strips (Basic and CAVFS)				
Maintenance Component	Recommended Inspection Frequency ¹	Defect or Problem	Condition When Maintenance is Needed	Results Expected When Maintenance Is Performed
Inlet/Outlet Pipe (continued)	A	Damaged	<ul style="list-style-type: none"> Cracks wider than ½ inch at the joint of the inlet/outlet pipes Any evidence of soil entering at the joints of the inlet/outlet pipes 	No cracks more than ¼-inch wide at the joint of the inlet/outlet pipe

¹ [Inspection frequency:](#)

[A = Annually; B = Biannually; M = Monthly; E = Recommend that additional inspections be performed as appropriate after major events \(e.g., >1 inch of precipitation in 24 hours or environmental incident that causes contaminant release; Q = Quarterly \(four times per year\); W = Recommend that at least one inspection occur during the wet season, preferably after trees have lost their leaves](#)

No. 12 - Wet Ponds				
Maintenance Component	<u>Recommended Inspection Frequency</u>¹	Defect or Problem	Condition When Maintenance is Needed	Results Expected When Maintenance Is Performed
Facility – General Requirements	A	Trash and debris	Any trash and/or debris accumulated at the site	No trash or debris at the site
	M (March – October)	Noxious weeds	Any noxious or nuisance vegetation which may constitute a hazard to City personnel or the public	<ul style="list-style-type: none"> • Noxious and nuisance vegetation removed according to applicable regulations • No danger of noxious vegetation where City personnel or the public might normally be
	A, E	Contaminants and pollution	Any evidence of contaminants or pollution such as oil, gasoline, concrete slurries, or paint	<ul style="list-style-type: none"> • Materials removed and disposed of according to applicable regulations • Source control BMPs implemented if appropriate • No contaminants present other than a surface oil film
	2X: June – October	Grass/groundcover	Grass or groundcover exceeds 18 inches in height	Grass or groundcover mowed to a height no greater than 6 inches
Side Slopes of Dam, Berm, Internal Berm or Embankment	A	Rodent holes	<ul style="list-style-type: none"> • Any evidence of rodent holes if facility is acting as a dam or berm • Any evidence of water piping through dam or berm via rodent holes 	<ul style="list-style-type: none"> • Rodents removed or destroyed • Dam or berm repaired

No. 12 - Wet Ponds				
Maintenance Component	<u>Recommended Inspection Frequency</u>¹	Defect or Problem	Condition When Maintenance is Needed	Results Expected When Maintenance Is Performed
Side Slopes of Dam, Berm, Internal Berm or Embankment (continued)	A	Tree growth	Tree growth threatens integrity of dams, berms or slopes, does not allow maintenance access, or interferes with maintenance activity. If trees are not a threat to dam, berm or embankment integrity, are not interfering with access or maintenance, or leaves do not cause a plugging problem they do not need to be removed.	Trees do not hinder facility performance or maintenance activities
	A	Erosion	<ul style="list-style-type: none"> • Eroded damage over 2 inches deep where cause of damage is still present or where there is potential for continued erosion • Any erosion observed on a compacted slope 	Slopes stabilized using appropriate erosion control measures If erosion is occurring on compacted slope, a licensed engineer should be consulted to resolve source of erosion.
Top or Side Slopes of Dam, Berm, Internal Berm or Embankment	A	Settlement	Any part of a dam, berm or embankment that has settled 4 inches lower than the design elevation	Top or side slope restored to design dimensions If settlement is significant, a licensed engineer should be consulted to determine the cause of the settlement.
	A	Irregular surface on internal berm	Top of berm not uniform and level	Top of berm graded to design elevation.
Pond Areas	A	Sediment accumulation (except first wet pool cell)	Accumulated sediment that exceeds 10 percent of the designed pond depth	Sediment cleaned out to designed pond shape and depth.

No. 12 - Wet Ponds				
Maintenance Component	<u>Recommended Inspection Frequency</u>¹	Defect or Problem	Condition When Maintenance is Needed	Results Expected When Maintenance Is Performed
Pond Areas (continued)	A	Sediment accumulation (first wet pool cell)	Sediment accumulations in pond bottom that exceeds the depth of sediment storage (1 foot) plus 6 inches	Sediment storage contains no sediment
	A	Liner damaged (if applicable)	<ul style="list-style-type: none"> • Liner is visible • Pond does not hold water as designed 	Liner repaired or replaced.
	A, W	Water level (first wet pool cell)	First cell empty; does not hold water	Water retained in first cell for most of the year
	M (March – October)	Algae mats (first wet pool cell)	Algae mats develop over more than 10 percent of the water surface	Algae mats removed (usually in the late summer before fall rains)
Gravity Drain	A	Inoperable valve	Valve will not open and close	Valve opens and closes normally
	A	Valve will not seal	Valve does not seal completely	Valve completely seals closed
Emergency Overflow Spillway	A	Tree growth	Tree growth impedes flow or threatens stability of spillway	Trees removed
	A	Rock missing	<ul style="list-style-type: none"> • Only one layer of rock exists above native soil in area 5 square feet or larger • Any exposure of native soil at the top of out flow path of spillway (Rip-rap on inside slopes need not be replaced.)	Spillway restored to design standards
Inlet/Outlet Pipe	A	Sediment accumulation	Sediment filling 1/3 or more of the pipe	Inlet/outlet pipes clear of sediment
	B, W, E	Trash and debris	Trash and debris accumulated in inlet/outlet pipes (includes floatables and non-floatables)	No trash or debris in pipes

No. 12 - Wet Ponds				
Maintenance Component	<u>Recommended Inspection Frequency</u> ¹	Defect or Problem	Condition When Maintenance is Needed	Results Expected When Maintenance Is Performed
<u>Inlet/Outlet Pipe (continued)</u>	<u>A</u>	Damaged	<ul style="list-style-type: none"> Cracks wider than ½ inch at the joint of the inlet/outlet pipes Any evidence of soil entering at the joints of the inlet/outlet pipes 	No cracks more than ¼-inch wide at the joint of the inlet/outlet pipe

¹ Inspection frequency:

A = Annually; B = Biannually; M = Monthly; E = Recommend that additional inspections be performed as appropriate after major events (e.g., >1 inch of precipitation in 24 hours or environmental incident that causes contaminant release; Q = Quarterly (four times per year); W = Recommend that at least one inspection occur during the wet season, preferably after trees have lost their leaves

No. 13 - Wet Vaults				
Maintenance Component	Recommended Inspection Frequency ¹	Defect or Problem	Condition When Maintenance is Needed	Results Expected When Maintenance is Performed
Facility – General Requirements	A	Trash and debris	Trash and debris accumulation	Trash and debris removed from facility
Treatment Area	A	Trash and debris	Any trash and debris accumulated in vault (includes floatables and non-floatables)	No trash or debris in vault
	A	Sediment accumulation	Sediment accumulation in vault bottom exceeds the depth of the sediment zone plus 6 inches	No sediment in vault
	A, E	Contaminants and pollution	Any evidence of contaminants or pollution such as oil, gasoline, concrete slurries, or paint	<ul style="list-style-type: none"> Materials removed and disposed of according to applicable regulations Source control BMPs implemented if appropriate No contaminants present other than a surface oil film
Vault Structure	A	Damage to wall, frame, bottom, and/or top slab	<ul style="list-style-type: none"> Cracks wider than ½ inch Any evidence of soil entering the structure through cracks Vault does not retain water Qualified inspection personnel determines that the vault is not structurally sound 	Vault sealed and structurally sound
	A	Baffles damaged	<ul style="list-style-type: none"> Baffles corroding, cracking, warping, and/or showing signs of failure Baffle cannot be removed 	Repair or replace baffles or walls to specifications
	A	Ventilation	Ventilation area blocked or plugged	No reduction of ventilation area exists

No. 13 - Wet Vaults				
Maintenance Component	Recommended Inspection Frequency ¹	Defect or Problem	Condition When Maintenance is Needed	Results Expected When Maintenance is Performed
Inlet/Outlet Pipe	A	Sediment accumulation	Sediment filling 1/3 or more of the pipe	Inlet/outlet pipes clear of sediment
	B, W, E	Trash and debris	Trash and debris accumulated in inlet/outlet pipes (includes floatables and non-floatables)	No trash or debris in pipes
	A	Damaged	<ul style="list-style-type: none"> Cracks wider than ½ inch at the joint of the inlet/outlet pipes Any evidence of soil entering at the joints of the inlet/outlet pipes 	No cracks more than ¼-inch wide at the joint of the inlet/outlet pipe
Gravity Drain	A	Inoperable valve	Valve will not open and close	Valve opens and closes normally
	A	Valve will not seal	Valve does not seal completely	Valve completely seals closed
Access Maintenance Hole	A	Access cover/lid damaged or difficult to open	<ul style="list-style-type: none"> Access cover/lid cannot be easily opened by one person Corrosion/deformation of cover/lid 	Access cover/lid can be opened by one person
	A	Locking mechanism not working	<ul style="list-style-type: none"> Mechanism cannot be opened by one maintenance person with proper tools Bolts cannot be seated Self-locking cover/lid does not work 	Mechanism opens with proper tools
	A	Cover/lid difficult to remove	One maintenance person cannot remove cover/lid after applying 80 lbs of lift	Cover/lid can be removed and reinstalled by one maintenance person
	A	Access doors/plate has gaps, does not cover completely	Large access doors not flat and/or access opening not completely covered	Doors close flat and covers access opening completely

No. 13 - Wet Vaults				
Maintenance Component	Recommended Inspection Frequency ¹	Defect or Problem	Condition When Maintenance is Needed	Results Expected When Maintenance is Performed
Access Maintenance Hole (continued)	A	Lifting rings missing, rusted	Lifting rings not capable of lifting weight of door or plate	Lifting rings sufficient to lift or remove door or plate
	A	Ladder rungs unsafe	Missing rungs, misalignment, rust, or cracks	Ladder meets design standards and allows maintenance person safe access

¹ [Inspection frequency:](#)

[A = Annually; B = Biannually; M = Monthly; E = Recommend that additional inspections be performed as appropriate after major events \(e.g., >1 inch of precipitation in 24 hours or environmental incident that causes contaminant release; Q = Quarterly \(four times per year\); W = Recommend that at least one inspection occur during the wet season, preferably after trees have lost their leaves](#)

No. 14 - Stormwater Treatment Wetlands				
Maintenance Component	Recommended Inspection Frequency¹	Defect or Problem	Condition When Maintenance is Needed	Results Expected When Maintenance Is Performed
Facility – General Requirements	A	Trash and debris	Trash and debris accumulation	Trash and debris removed from facility
	M (March – October)	Noxious weeds	Any noxious or nuisance vegetation which may constitute a hazard to City personnel or the public	<ul style="list-style-type: none"> • Noxious and nuisance vegetation removed according to applicable regulations • No danger of noxious vegetation where City personnel or the public might normally be
	A, E	Contaminants and pollution	Any evidence of contaminants or pollution such as oil, gasoline, concrete slurries, or paint	<ul style="list-style-type: none"> • Materials removed and disposed of according to applicable regulations • Source control BMPs implemented if appropriate • No contaminants present other than a surface oil film
	2X: June – October	Grass/groundcover	Grass or groundcover exceeds 18 inches in height	Grass or groundcover mowed to a height no greater than 6 inches
Side Slopes of Dam, Berm, Internal Berm, or Embankment	A	Rodent holes	<p>Any evidence of rodent holes if facility is acting as a dam or berm</p> <p>Any evidence of water piping through dam or berm via rodent holes</p>	<ul style="list-style-type: none"> • Rodents removed or destroyed • Dam or berm repaired

No. 14 - Stormwater Treatment Wetlands				
Maintenance Component	<u>Recommended Inspection Frequency</u> ¹	Defect or Problem	Condition When Maintenance is Needed	Results Expected When Maintenance Is Performed
Side Slopes of Dam, Berm, Internal Berm, or Embankment (continued)	<u>A</u>	Tree growth	Tree growth threatens integrity of dams, berms or slopes, does not allow maintenance access, or interferes with maintenance activity. If trees are not a threat to dam, berm, or embankment integrity or not interfering with access or maintenance, they do not need to be removed.	Trees do not hinder facility performance or maintenance activities
	<u>A</u>	Erosion	<ul style="list-style-type: none"> Eroded damage over 2 inches deep where cause of damage is still present or where there is potential for continued erosion Any erosion observed on a compacted slope 	<p>Slopes stabilized using appropriate erosion control measures</p> <p>If erosion is occurring on compacted slope, a licensed engineer should be consulted to resolve source of erosion.</p>
Top or Side Slopes of Dam, Berm, Internal Berm, or Embankment	<u>A</u>	Settlement	Any part of a dam, berm or embankment that has settled 4 inches lower than the design elevation	<p>Top or side slope restored to design dimensions</p> <p>If settlement is significant, a licensed engineer should be consulted to determine the cause of the settlement.</p>
	<u>A</u>	Irregular surface on internal berm	Top of berm not uniform and level	Top of berm graded flat to design elevation
Pond Areas	<u>B</u>	Sediment accumulation (first cell/forebay)	Sediment accumulations in pond bottom that exceeds the depth of sediment storage (1 foot) plus 6 inches	Sediment storage contains no sediment

No. 14 - Stormwater Treatment Wetlands				
Maintenance Component	<u>Recommended Inspection Frequency</u> ¹	Defect or Problem	Condition When Maintenance is Needed	Results Expected When Maintenance Is Performed
Pond Areas (continued)	<u>B</u>	Sediment accumulation (wetland cell)	Accumulated sediment that exceeds 10 percent of the designed pond depth	Sediment cleaned out to designed pond shape and depth
	<u>A</u>	Liner damaged (If Applicable)	Liner is visible or pond does not hold water as designed	Liner repaired or replaced
	<u>A, W</u>	Water level (first cell/forebay)	Cell does not hold 3 feet of water year round	3 feet of water retained year round
	<u>A, W</u>	Water level (wetland cell)	Cell does not retain water for at least 10 months of the year or wetland plants are not surviving.	Water retained at least 10 months of the year or wetland plants are surviving.
	<u>M (March – October)</u>	Algae mats (first cell/forebay)	Algae mats develop over more than 10 percent of the water	Algae mats removed (usually in the late summer before fall rains)
	<u>B</u>	Vegetation	Vegetation dead, dying, or overgrown (cattails) or not meeting original planting specifications	Plants in wetland cell surviving and not interfering with wetland function
Gravity Drain	<u>A</u>	Inoperable valve	Valve will not open and close	Valve opens and closes normally
	<u>A</u>	Valve will not seal	Valve does not seal completely	Valve completely seals closed
Emergency Overflow Spillway	<u>A</u>	Tree growth	Tree growth impedes flow or threatens stability of spillway	Trees removed
	<u>A</u>	Rock missing	<ul style="list-style-type: none"> • Only one layer of rock exists above native soil in area 5 square feet or larger • Any exposure of native soil at the top of out flow path of spillway (Rip-rap on inside slopes need not be replaced.)	Spillway restored to design standards
Inlet/Outlet Pipe	<u>A</u>	Sediment accumulation	Sediment filling 1/3 or more of the pipe	Inlet/outlet pipes clear of sediment

No. 14 - Stormwater Treatment Wetlands				
Maintenance Component	<u>Recommended Inspection Frequency</u> ¹	Defect or Problem	Condition When Maintenance is Needed	Results Expected When Maintenance Is Performed
Inlet/Outlet Pipe (continued)	<u>B, W, E</u>	Trash and debris	Trash and debris accumulated in inlet/outlet pipes (includes floatables and non-floatables)	No trash or debris in pipes
	<u>A</u>	Damaged	<ul style="list-style-type: none"> Cracks wider than ½ inch at the joint of the inlet/outlet pipes Any evidence of soil entering at the joints of the inlet/outlet pipes 	No cracks more than ¼-inch wide at the joint of the inlet/outlet pipe

¹ Inspection frequency:

A = Annually; B = Biannually; M = Monthly; E = Recommend that additional inspections be performed as appropriate after major events (e.g., >1 inch of precipitation in 24 hours or environmental incident that causes contaminant release; Q = Quarterly (four times per year); W = Recommend that at least one inspection occur during the wet season, preferably after trees have lost their leaves

No. 15 - Sand Filter Basins				
Maintenance Component	<u>Recommended Inspection Frequency</u>¹	Defect or Problem	Condition When Maintenance is Needed	Results Expected When Maintenance Is Performed
Facility – General Requirements	A, E	Trash and debris	Trash and debris accumulation	Trash and debris removed from facility
	M (March – October)	Noxious weeds	Any noxious or nuisance vegetation which may constitute a hazard to City personnel or the public	<ul style="list-style-type: none"> • Noxious and nuisance vegetation removed according to applicable regulations • No danger of noxious vegetation where City personnel or the public might normally be
	A, E	Contaminants and pollution	Any evidence of contaminants or pollution such as oil, gasoline, concrete slurries, or paint	<ul style="list-style-type: none"> • Materials removed and disposed of according to applicable regulations • Source control BMPs implemented if appropriate • No contaminants present other than a surface oil film
	A	Grass/groundcover (not in the treatment area)	Grass or groundcover exceeds 18 inches in height	Grass or groundcover mowed to a height no greater than 6 inches
Pre-Treatment (if applicable)	A	Sediment accumulation	Sediment accumulations in pond bottom that exceeds the depth of sediment storage (1 foot) plus 6 inches	Sediment storage contains no sediment
	A	Liner damaged (If Applicable)	Liner is visible Pond does not hold water as designed	Liner repaired or replaced
	A, W	Water level	Cell empty; does not hold water.	Water retained in first cell for most of the year
	M (March – October)	Algae mats	Algae mats develop over more than 10 percent of the water surface	Algae mats removed

No. 15 - Sand Filter Basins				
Maintenance Component	Recommended Inspection Frequency ¹	Defect or Problem	Condition When Maintenance is Needed	Results Expected When Maintenance Is Performed
Pond Area	B	Sediment accumulation	Sediment or crust depth exceeds ½ inch over 10 percent of surface area of sand filter	No sediment or crust deposit on sand filter that would impede permeability of the filter section
	2X: June – October	Grass (if applicable)	<ul style="list-style-type: none"> Grass becomes excessively tall (greater than 6 inches) Nuisance weeds and other vegetation start to take over Thatch build up occurs 	Mow vegetation and/or remove nuisance vegetation
Side Slopes of Pond	A	Rodent holes	<ul style="list-style-type: none"> Any evidence of rodent holes if facility is acting as a dam or berm Any evidence of water piping through dam or berm via rodent holes 	Rodents removed or destroyed Dam or berm repaired
	A	Tree growth	<p>Tree growth threatens integrity of dams, berms or slopes, does not allow maintenance access, or interferes with maintenance activity.</p> <p>If trees are not a threat to dam, berm, or embankment integrity or not interfering with access or maintenance, they do not need to be removed.</p>	Trees do not hinder facility performance or maintenance activities

No. 15 - Sand Filter Basins				
Maintenance Component	Recommended Inspection Frequency ¹	Defect or Problem	Condition When Maintenance is Needed	Results Expected When Maintenance Is Performed
Side Slopes of Pond (continued)	A	Erosion	<ul style="list-style-type: none"> Eroded damage over 2 inches deep where cause of damage is still present Where there is potential for continued erosion Any erosion observed on a compacted slope 	<p>Slopes stabilized using appropriate erosion control measures</p> <p>If erosion is occurring on compacted slope, a licensed engineer should be consulted to resolve source of erosion.</p>
Sand Filter Media	A, E	Plugging	<ul style="list-style-type: none"> Drawdown of water through the sand filter media, takes longer than 24 hours Flow through the overflow pipes occurs frequently 	<ul style="list-style-type: none"> Sand filter media surface is aerated Drawdown rate is normal
	A	Prolonged flows	Sand is saturated for prolonged periods of time (several weeks) and does not dry out between storms due to continuous base flow or prolonged flows from detention facilities	Excess flows bypassed or confined to small portion of filter media surface
	A	Short circuiting	<ul style="list-style-type: none"> Flows become concentrated over one section of the sand filter rather than dispersed Drawdown rate of pool exceeds 12 inches per hour 	<ul style="list-style-type: none"> Flow and percolation of water through the sand filter is uniform and dispersed across the entire filter area Drawdown rate is normal
	A	Media thickness	Sand thickness is less than 6 inches	Rebuild sand thickness to a minimum of 6 inches and preferably to 18 inches

No. 15 - Sand Filter Basins				
Maintenance Component	Recommended Inspection Frequency ¹	Defect or Problem	Condition When Maintenance is Needed	Results Expected When Maintenance Is Performed
Underdrains and Clean-Outs	A	Sediment/debris	<ul style="list-style-type: none"> Underdrains or clean-outs partially plugged or filled with sediment and/or debris Junction box/cleanout wyes not watertight 	Underdrains and clean-outs free of sediment and debris and are watertight
Inlet/Outlet Pipe	A	Sediment accumulation	Sediment filling 1/3 or more of the pipe	Inlet/outlet pipes clear of sediment
	B, W, E	Trash and debris	Trash and debris accumulated in inlet/outlet pipes (includes floatables and non-floatables)	No trash or debris in pipes
	A	Damaged	<ul style="list-style-type: none"> Cracks wider than ½ inch at the joint of the inlet/outlet pipes Any evidence of soil entering at the joints of the inlet/outlet pipes 	No cracks more than ¼-inch wide at the joint of the inlet/outlet pipe
Rock Pad	A	Missing or out of place	<ul style="list-style-type: none"> Only one layer of rock exists above native soil in area 5 square feet or larger Any exposure of native soil 	Rock pad restored to design standards
Flow Spreader	A	Concentrated flow	Flow from spreader not uniformly distributed across sand filter	Flows spread evenly over sand filter

¹ [Inspection frequency:](#)

[A = Annually; B = Biannually; M = Monthly; E = Recommend that additional inspections be performed as appropriate after major events \(e.g., >1 inch of precipitation in 24 hours or environmental incident that causes contaminant release; Q = Quarterly \(four times per year\); W = Recommend that at least one inspection occur during the wet season, preferably after trees have lost their leaves](#)

No. 16 - Sand Filter Vaults				
Maintenance Component	<u>Recommended Inspection Frequency</u>¹	Defect or Problem	Condition When Maintenance is Needed	Results Expected When Maintenance is Performed
Facility – General Requirements	A, E	Trash and debris	Trash and debris accumulation	Trash and debris removed from facility
	M (March – October)	Noxious weeds	Any noxious or nuisance vegetation which may constitute a hazard to City personnel or the public	<ul style="list-style-type: none"> • Noxious and nuisance vegetation removed according to applicable regulations • No danger of noxious vegetation where City personnel or the public might normally be
	A, E	Contaminants and pollution	Any evidence of contaminants or pollution such as oil, gasoline, concrete slurries, or paint	<ul style="list-style-type: none"> • Materials removed and disposed of according to applicable regulations • Source control BMPs implemented if appropriate • No contaminants present other than a surface oil film
	A	Grass/groundcover	Grass or groundcover exceeds 18 inches in height	Grass or groundcover mowed to a height no greater than 6 inches
Pre-Treatment Chamber	A	Sediment accumulation	Sediment accumulation exceeds the depth of the sediment zone plus 6 inches	Sediment storage contains no sediment
Sand Filter Media	A	Sediment accumulation	Sediment depth exceeds ½ inch on sand filter media	Sand filter freely drains at normal rate
	A	Trash and debris	Trash and debris accumulated in vault (floatables and non-floatables)	No trash or debris in vault

No. 16 - Sand Filter Vaults				
Maintenance Component	Recommended Inspection Frequency ¹	Defect or Problem	Condition When Maintenance is Needed	Results Expected When Maintenance is Performed
Sand Filter Media (continued)	A, E	Plugging	<ul style="list-style-type: none"> • Drawdown of water through the sand filter media, takes longer than 24 hours • Flow through the overflow pipes occurs frequently 	Sand filter media drawdown rate is normal
	A	Short circuiting	<ul style="list-style-type: none"> • Seepage or flow occurs along the vault walls and corners • Sand eroding near inflow area • Cleanout wyes are not watertight 	<ul style="list-style-type: none"> • Sand filter media section re-laid and compacted along perimeter of vault to form a semi-seal • Erosion protection added to dissipate force of incoming flow and curtail erosion
Vault Structure	A	Damaged to walls, frame, bottom and/or top slab.	<ul style="list-style-type: none"> • Cracks wider than ½ inch • Any evidence of soil entering the structure through cracks • Qualified inspection personnel determines that the vault is not structurally sound 	Vault replaced or repaired to provide complete sealing of the structure
	A	Ventilation	Ventilation area blocked or plugged	No reduction of ventilation area exists
Underdrains and Cleanouts	A	Sediment/debris	Underdrains or clean-outs partially plugged, filled with sediment and/or debris or not watertight	Underdrains and clean-outs free of sediment and debris and sealed
Inlet/Outlet Pipe	A	Sediment accumulation	Sediment filling 1/3 or more of the pipe	Inlet/outlet pipes clear of sediment
	B, W, E	Trash and debris	Trash and debris accumulated in inlet/outlet pipes (includes floatables and non-floatables)	No trash or debris in pipes

No. 16 - Sand Filter Vaults				
Maintenance Component	Recommended Inspection Frequency ¹	Defect or Problem	Condition When Maintenance is Needed	Results Expected When Maintenance is Performed
Inlet/Outlet Pipe (continued)	A	Damaged	<ul style="list-style-type: none"> Cracks wider than ½ inch at the joint of the inlet/outlet pipes Any evidence of soil entering at the joints of the inlet/outlet pipes 	No cracks more than ¼-inch wide at the joint of the inlet/outlet pipe
Access Maintenance Hole	A	Cover/lid not in place	<ul style="list-style-type: none"> Cover/lid is missing or only partially in place Any open maintenance hole requires immediate maintenance 	Maintenance hole access cover/lid in place and secure
	A	Locking mechanism not working	<ul style="list-style-type: none"> Mechanism cannot be opened by one maintenance person with proper tools Bolts cannot be seated Self-locking cover/lid does not work 	Mechanism opens with proper tools
	A	Cover/lid difficult to remove	One maintenance person cannot remove cover/lid after applying 80 lbs of lift	Cover/lid can be removed and reinstalled by one maintenance person
	A	Ladder rungs unsafe	Missing rungs, misalignment, rust, or cracks	Ladder meets design standards and allows maintenance person safe access
Large Access Doors/Plate	A	Damaged or difficult to open	Large access doors or plates cannot be opened/removed using normal equipment	Replace or repair access door so it can open as designed
	A	Gaps, does not cover completely	Large access doors not flat and/or access opening not completely covered	Doors close flat and covers access opening completely

No. 16 - Sand Filter Vaults				
Maintenance Component	<u>Recommended Inspection Frequency</u>¹	Defect or Problem	Condition When Maintenance is Needed	Results Expected When Maintenance is Performed
Large Access Doors/Plate (continued)	A	Lifting rings missing, rusted	Lifting rings not capable of lifting weight of door or plate	Lifting rings sufficient to lift or remove door or plate

¹ Inspection frequency:

A = Annually; B = Biannually; M = Monthly; E = Recommend that additional inspections be performed as appropriate after major events (e.g., >1 inch of precipitation in 24 hours or environmental incident that causes contaminant release; Q = Quarterly (four times per year); W = Recommend that at least one inspection occur during the wet season, preferably after trees have lost their leaves

No. 17 - Proprietary Technology Filter Cartridge Type Filter Systems (example: BayFilter, FloGard PerkFilter, StormFilter)				
Maintenance Component	Recommended Inspection Frequency ^{1,2}	Defect or Problem	Condition When Maintenance is Needed	Results Expected When Maintenance is Performed
In addition to the specific maintenance criteria provided below, all manufacturers' requirements shall be followed.				
Facility – General Requirements	A, E	Trash and debris	Any trash or debris or organic material which impairs the function of the facility	<ul style="list-style-type: none"> • Trash and debris removed from facility • Flow receives treatment instead of bypassing
	A, E	Contaminants and pollution	Any evidence of contaminants or pollution such as oil, gasoline, concrete slurries, or paint	<ul style="list-style-type: none"> • Materials removed and disposed of according to applicable regulations • Source control BMPs implemented if appropriate • No contaminants present other than a surface oil film
	A	Life cycle	Once per year	Facility is re-inspected and any needed maintenance performed
Vault Treatment Area	Varies – Refer to Manufacturer's requirements.	Sediment on vault floor	Varies – Refer to Manufacturer's requirements.	Vault is free of sediment
	Varies – Refer to Manufacturer's requirements.	Sediment on top of cartridges	Varies – Refer to Manufacturer's requirements.	Vault is free of sediment
	Varies – Refer to Manufacturer's requirements.	Multiple scum lines above top of cartridges	Thick or multiple scum lines above top of cartridges	Cause of plugging corrected and canisters replaced if necessary

No. 17 - Proprietary Technology <u>Filter Cartridge Type Filter</u> Systems (example: BayFilter, FloGard PerkFilter, StormFilter)				
Maintenance Component	Recommended Inspection Frequency ^{1,2}	Defect or Problem	Condition When Maintenance is Needed	Results Expected When Maintenance is Performed
Vault Structure	A	Damage to wall, frame, bottom, and/or top slab	<ul style="list-style-type: none"> Cracks wider than ½ inch Any evidence of soil particles entering the structure through the cracks Qualified inspection personnel determines the vault is not structurally sound 	Vault replaced or repaired to design specifications
	A	Baffles damaged	Baffles corroding, cracking warping, and/or showing signs of failure	Repair or replace baffles to specification
Filter Media	A, E	Standing water in vault	Varies – Refer to Manufacturer's requirements.	No standing water in vault 24 hours after a rain event
	A	Short circuiting	Flows do not properly enter filter cartridges	Flows go through filter media
Underdrains and Clean-Outs	A	Sediment/debris	Underdrains or clean-outs partially plugged or filled with sediment and/or debris	Underdrains and clean-outs free of sediment and debris
Inlet/Outlet Pipe	A	Sediment accumulation	Sediment filling 1/3 or more of the pipe	Inlet/outlet pipes clear of sediment
	B, W, E	Trash and debris	Trash and debris accumulated in inlet/outlet pipes (includes floatables and non-floatables)	No trash or debris in pipes
	A	Damaged	<ul style="list-style-type: none"> Cracks wider than ½ inch at the joint of the inlet/outlet pipes Any evidence of soil entering at the joints of the inlet/outlet pipes 	Cracks repaired, and no evidence of soil entering

No. 17 - Proprietary Technology Filter Cartridge Type Filter Systems (example: BayFilter, FloGard PerkFilter, StormFilter)				
Maintenance Component	Recommended Inspection Frequency ^{1,2}	Defect or Problem	Condition When Maintenance is Needed	Results Expected When Maintenance is Performed
Access Maintenance Hole	A	Cover/lid not in place	<ul style="list-style-type: none"> Cover/lid is missing or only partially in place Any open maintenance hole requires immediate maintenance 	Maintenance hole access cover/lid in place and secure
	A	Locking mechanism not working	<ul style="list-style-type: none"> Mechanism cannot be opened by one maintenance person with proper tools Bolts cannot be seated Self-locking cover/lid does not work 	Mechanism opens with proper tools
	A	Cover/lid difficult to remove	One maintenance person cannot remove cover/lid after applying 80 lbs of lift	Cover/lid can be removed and reinstalled by one maintenance person
	A	Cover/lid rocking or noisy	Lid rocking when driven over	Cover/lid not rocking
	A	Ladder rungs unsafe	Missing rungs, misalignment, rust, or cracks	Ladder meets design standards and allows maintenance person safe access
Large Access Doors/Plate	A	Difficult to open	Large access doors or plates cannot be opened/removed using normal equipment	Replace or repair access door so it can open as designed.
	A	Damaged	Hatch doors show major dents and stress	Replace to support surface loading and uses
	A	Gaps, does not cover completely	Large access doors not flat and/or access opening not completely covered.	Doors close flat and cover access opening completely.

No. 17 - Proprietary Technology Filter Cartridge Type Filter Systems (example: BayFilter, FloGard PerkFilter, StormFilter)				
Maintenance Component	Recommended Inspection Frequency ^{1,2}	Defect or Problem	Condition When Maintenance is Needed	Results Expected When Maintenance is Performed
Large Access Doors/Plate (continued)	A	Lifting rings missing, rusted	Lifting rings not capable of lifting weight of door or plate.	Lifting rings sufficient to lift or remove door or plate.

¹ [Inspection frequency:](#)

[A = Annually; B = Biannually; M = Monthly; E = Recommend that additional inspections be performed as appropriate after major events \(e.g., >1 inch of precipitation in 24 hours or environmental incident that causes contaminant release; Q = Quarterly \(four times per year\); W = Recommend that at least one inspection occur during the wet season, preferably after trees have lost their leaves](#)

² [Inspection frequencies provided are recommendations only. Proprietary technologies shall be inspected on a frequency as recommended by the manufacturer.](#)

No. 18 - API Oil/Water Separators				
Maintenance Component	Recommended Inspection Frequency ¹	Defect	Condition When Maintenance is Needed	Results Expected When Maintenance is Performed
Facility – General Requirements	A, E	Trash and debris	Any trash or debris which impairs the function of the facility	Trash and debris removed from facility
	A, E	Contaminants and pollution	Floating oil in excess of 1 inch in first chamber, any oil in other chambers or other contaminants of any type in any chamber	No contaminants present other than a surface oil film
Vault Treatment Area	A, E	Sediment accumulation	Sediment accumulates exceeds 6 inches in the vault	No sediment in the vault.
	A, E	Discharge water not clear	Inspection of discharge water shows obvious signs of poor water quality- effluent discharge from vault shows thick visible sheen	Effluent discharge is clear
	A, E	Trash or debris accumulation	Any trash and debris accumulation in vault (floatables and non-floatables)	Vault is clear of trash and debris
	A, E	Oil accumulation	Oil accumulations that exceed 1 inch, at the surface of the water in the oil/water separator chamber	No visible oil depth on water
Vault Structure	A	Damage to wall, frame, bottom, and/or top slab	<ul style="list-style-type: none"> Cracks wider than ½ inch Any evidence of soil particles entering the structure through the cracks Maintenance/inspection personnel determines that the vault is not structurally sound 	Vault replaced or repaired to design specifications
	A	Baffles damaged	Baffles corroding, cracking, warping and/or showing signs of failure	Repair or replace baffles to specifications

No. 18 - API Oil/Water Separators				
Maintenance Component	<u>Recommended Inspection Frequency¹</u>	Defect	Condition When Maintenance is Needed	Results Expected When Maintenance is Performed
Gravity Drain	A	Inoperable valve	Valve will not open and close	Valve opens and closes normally
	A	Valve will not seal	Valve does not seal completely	Valve completely seals closed
Inlet/Outlet Pipe	A	Sediment accumulation	Sediment filling 1/3 or more of the pipe	Inlet/outlet pipes clear of sediment
	B, W, E	Trash and debris	Trash and debris accumulated in inlet/outlet pipes (includes floatables and non-floatables)	No trash or debris in pipes
	A	Damaged	Cracks, broken welds, seams or any other conditions that allows water to be discharged from other than the submerged portion of the tee	Water will be discharged from the submerged portion of the tee
	A	Missing	When the required inlet or outlet tee is not installed	Tees installed
	A	Permanently installed	When the tee is grouted to the inlet or outlet pipe and is not removable to allow for maintenance and inspection	Tee removable for maintenance and inspection
	Access Maintenance Hole	A	Cover/lid not in place	<ul style="list-style-type: none"> Cover/lid is missing or only partially in place Any open maintenance hole requires immediate maintenance
A		Locking mechanism not working	<ul style="list-style-type: none"> Mechanism cannot be opened by one maintenance person with proper tools Bolts cannot be seated Self-locking cover/lid does not work 	Mechanism opens with proper tools
A		Cover/lid difficult to remove	One maintenance person cannot remove cover/lid after applying 80 lbs of lift	Cover/lid can be removed and reinstalled by one maintenance person

No. 18 - API Oil/Water Separators				
Maintenance Component	Recommended Inspection Frequency ¹	Defect	Condition When Maintenance is Needed	Results Expected When Maintenance is Performed
Access Maintenance Hole (continued)	A	Ladder rungs unsafe	Missing rungs, misalignment, rust, or cracks	Ladder meets design standards and allows maintenance person safe access
Large Access Doors/Plate	A	Damaged or difficult to open	Large access doors or plates cannot be opened/removed using normal equipment	Replace or repair access door so it can open as designed
	A	Gaps, does not cover completely	Large access doors not flat and/or access opening not completely covered	Doors close flat and cover access opening completely
	A	Lifting rings missing, rusted	Lifting rings not capable of lifting weight of door or cover/lid	Lifting rings sufficient to lift or remove cover/lid

¹ [Inspection frequency:](#)

[A = Annually; B = Biannually; M = Monthly; E = Recommend that additional inspections be performed as appropriate after major events \(e.g., >1 inch of precipitation in 24 hours or environmental incident that causes contaminant release; Q = Quarterly \(four times per year\); W = Recommend that at least one inspection occur during the wet season, preferably after trees have lost their leaves](#)

No. 19 - Coalescing Plate Oil/Water Separators				
Maintenance Component	Recommended Inspection Frequency¹	Defect	Condition When Maintenance is Needed	Results Expected When Maintenance is Performed
Facility – General Requirements	A, E	Trash and debris	Any trash or debris which impairs the function of the facility	Trash and debris removed from facility
	A, E	Contaminants and pollution	Floating oil in excess of 1 inch in first chamber, any oil in other chambers or other contaminants of any type in any chamber	No contaminants present other than a surface oil film
Vault Treatment Area	A, E	Sediment accumulation in the forebay	Sediment accumulation of 6 inches or greater in the forebay	No sediment in the forebay
	A, E	Discharge water not clear	Inspection of discharge water shows obvious signs of poor water quality – effluent discharge from vault shows thick visible sheen	Repair function of plates so effluent is clear
	A, E	Trash or debris accumulation	Trash and debris accumulation in vault (floatables and non-floatables)	Trash and debris removed from vault
	A, E	Oil accumulation	Oil accumulation that exceeds 1 inch at the water surface in the in the coalescing plate chamber	No visible oil depth on water and coalescing plates clear of oil
Coalescing Plates	A	Damaged	Plate media broken, deformed, cracked and/or showing signs of failure	Replace that portion of media pack or entire plate pack depending on severity of failure
	A, E	Sediment accumulation	Any sediment accumulation which interferes with the operation of the coalescing plates	No sediment accumulation interfering with the coalescing plates

No. 19 - Coalescing Plate Oil/Water Separators				
Maintenance Component	Recommended Inspection Frequency¹	Defect	Condition When Maintenance is Needed	Results Expected When Maintenance is Performed
Vault Structure	A	Damage to wall, frame, bottom, and/or top slab	<ul style="list-style-type: none"> • Cracks wider than ½ inch • Any evidence of soil particles entering the structure through the cracks • Maintenance inspection personnel determines that the vault is not structurally sound 	Vault replaced or repaired to design specifications
	A	Baffles damaged	Baffles corroding, cracking, warping and/or showing signs of failure	Repair or replace baffles to specifications
Ventilation Pipes	A	Plugged	Any obstruction to the ventilation pipes	Ventilation pipes are clear
Shutoff Valve	A	Damaged or inoperable	Shutoff valve cannot be opened or closed	Shutoff valve operates normally
Inlet/Outlet Pipe	A	Sediment accumulation	Sediment filling 1/3 or more of the pipe	Inlet/outlet pipes clear of sediment
	B, W, E	Trash and debris	Trash and debris accumulated in inlet/outlet pipes (includes floatables and non-floatables)	No trash or debris in pipes
	A	Damaged	Cracks, broken welds, seams or any other conditions that allows water to be discharged from other than the submerged portion of the tee	Water will be discharged from the submerged portion of the tee
	A	Missing	When the required inlet or outlet tee is not installed	Tees installed
	A	Permanently installed	When the tee is grouted to the inlet or outlet pipe and is not removable to allow for maintenance and inspection	Tee removable for maintenance and inspection

No. 19 - Coalescing Plate Oil/Water Separators				
Maintenance Component	Recommended Inspection Frequency¹	Defect	Condition When Maintenance is Needed	Results Expected When Maintenance is Performed
Access Maintenance Hole	A	Cover/lid not in place	<ul style="list-style-type: none"> Cover/lid is missing or only partially in place Any open maintenance hole requires immediate maintenance 	Maintenance hole access cover/lid in place and secure
	A	Locking mechanism not working	<ul style="list-style-type: none"> Mechanism cannot be opened by one maintenance person with proper tools Bolts cannot be seated Self-locking cover/lid does not work 	Mechanism opens with proper tools
	A	Cover/lid difficult to remove	One maintenance person cannot remove cover/lid after applying 80 lbs of lift	Cover/lid can be removed and reinstalled by one maintenance person
	A	Ladder rungs unsafe	Missing rungs, misalignment, rust, or cracks	Ladder meets design standards and allows maintenance person safe access
Large Access Doors/Plate	A	Damaged or difficult to open	Large access doors or plates cannot be opened/removed using normal equipment.	Replace or repair access door so it can be opened as designed
	A	Gaps, does not cover completely	Large access doors not flat and/or access opening not completely covered	Doors close flat and cover access opening completely
	A	Lifting rings missing, rusted	Lifting rings not capable of lifting weight of door or plate	Lifting rings sufficient to lift or remove door or plate

¹ [Inspection frequency:](#)

[A = Annually; B = Biannually; M = Monthly; E = Recommend that additional inspections be performed as appropriate after major events \(e.g., >1 inch of precipitation in 24 hours or environmental incident that causes contaminant release; Q = Quarterly \(four times per year\); W = Recommend that at least one inspection occur during the wet season, preferably after trees have lost their leaves](#)

No. 20 - Catch Basin Filter Socks <u>Inserts</u>				
Maintenance Component	Recommended Inspection Frequency ^{1,2}	Defect or Problem	Conditions When Maintenance is Needed	Results Expected When Maintenance is Performed
Media Insert ²	<u>M</u>	Visible oil	Visible oil sheen passing through media	Media insert replaced
	<u>M</u>	Insert does not fit catch basin properly	Flow gets into catch basin without going through media	All flow goes through media
	<u>M</u>	Filter media plugged	Filter media plugged	Flow through filter media is normal
	<u>M</u>	Oil absorbent media saturated	Media oil saturated	Oil absorbent media replaced
	<u>M</u>	Water saturated	Catch basin insert is saturated with water, which no longer has the capacity to absorb	Insert replaced
	<u>M</u>	Service life exceeded	Regular interval replacement due to typical average life of product	Media replaced at manufacturer's recommended interval

¹ [Inspection frequency:](#)

[A = Annually; B = Biannually; M = Monthly; E = Recommend that additional inspections be performed as appropriate after major events \(e.g., >1 inch of precipitation in 24 hours or environmental incident that causes contaminant release; Q = Quarterly \(four times per year\); W = Recommend that at least one inspection occur during the wet season, preferably after trees have lost their leaves](#)

² [Inspection frequencies provided are recommendations only. Catch basin filter socks shall be inspected on a frequency as recommended by the manufacturer.](#)

No. 21 - Proprietary Technology Filterra System				
Maintenance Component	Recommended Inspection Frequency ^{1,2}	Defect or Problem	Condition When Maintenance is Needed	Results Expected When Maintenance is Performed
In addition to the specific maintenance criteria provided below, all manufacturers' requirements shall be followed.				
Facility – General Requirements	A	Life cycle	Once per year, except mulch and trash removal twice per year	Facility is re-inspected and any needed maintenance performed
	B, E	Contaminants and pollution	Any evidence of contaminants or pollution such as oil, gasoline, concrete slurries, or paint	<ul style="list-style-type: none"> Materials removed and disposed of according to applicable regulations Source control BMPs implemented if appropriate No contaminants present other than a surface oil film
Inlet	B, E	Excessive sediment or trash accumulation	Accumulated sediments or trash impair free flow of water into system	Inlet should be free of obstructions allowing free distributed flow of water into system
Mulch Cover	B, E	Trash and floatable debris accumulation	Excessive trash and/or debris accumulation	<ul style="list-style-type: none"> Minimal trash or other debris on mulch cover Mulch cover raked level
	B, E	“Ponding” of water on mulch cover	“Ponding” in unit could be indicative of clogging due to excessive fine sediment accumulation or spill of petroleum oils	Stormwater should drain freely and evenly through mulch cover
Proprietary Filter Media/ Vegetation Substrate	B, E	“Ponding” of water on mulch cover after mulch cover has been maintained	Excessive fine sediment passes the mulch cover and clogs the filter media/vegetative substrate	<ul style="list-style-type: none"> Stormwater should drain freely and evenly through mulch cover Replace substrate and vegetation when needed

No. 21 - Proprietary Technology Filterra System				
Maintenance Component	Recommended Inspection Frequency ^{1,2}	Defect or Problem	Condition When Maintenance is Needed	Results Expected When Maintenance is Performed
Vegetation	B, E	Plants not growing or in poor condition	<ul style="list-style-type: none"> • Soil/mulch too wet • Evidence of spill • Incorrect plant selection • Pest infestation • Vandalism to plants 	Plants should be healthy and pest free
			Media/mulch too dry	Irrigation is required
	B, E	Plants absent	Plants absent	Appropriate plants are present
	B, E	Excessive plant growth	Excessive plant growth inhibits facility function or becomes a hazard for pedestrian and vehicular circulation and safety	<ul style="list-style-type: none"> • Pruning and/or thinning vegetation maintains proper plant density • Appropriate plants are present
Structure, if used	B	Structure has visible cracks	<ul style="list-style-type: none"> • Cracks wider than ½ inch • Evidence of soil particles entering the structure through the cracks 	Structure is sealed and structurally sound

¹ [Inspection frequency:](#)

[A = Annually; B = Biannually; M = Monthly; E = Recommend that additional inspections be performed as appropriate after major events \(e.g., >1 inch of precipitation in 24 hours or environmental incident that causes contaminant release; Q = Quarterly \(four times per year\); W = Recommend that at least one inspection occur during the wet season, preferably after trees have lost their leaves](#)

² [Inspection frequencies provided are recommendations only. Proprietary technologies shall be inspected on a frequency as recommended by the manufacturer.](#)

No. 22 - Proprietary Technology Modular Wetland System				
Maintenance Component	Recommended Inspection Frequency^{1,2}	Defect or Problem	Condition When Maintenance is Needed	Results Expected When Maintenance is Performed
<u>In addition to the specific maintenance criteria provided below, all manufacturers' requirements shall be followed.</u>				
<u>Facility – General Requirements</u>	<u>B</u>	<u>Trash and debris</u>	<u>Any trash or debris which impairs the function of the facility</u>	<u>Trash and debris removed from facility</u>
	<u>B</u>	<u>Contaminants and pollution</u>	<u>Any evidence of contaminants or pollution such as oil, gasoline, concrete slurries, or paint</u>	<ul style="list-style-type: none"> • <u>Materials removed and disposed of according to applicable regulations</u> • <u>Source control BMPs implemented if appropriate</u> • <u>No contaminants present other than a surface oil film</u>
	<u>B</u>	<u>Odor</u>	<u>Septic or foul odor coming from inside the system</u>	<u>Odors are eliminated</u>
	<u>B</u>	<u>Standing water</u>	<u>Standing water observed after a prolonged dry period</u>	<u>No standing water</u>
<u>Inlet/Outlet Pipe</u>	<u>B</u>	<u>Excessive sediment or trash accumulation</u>	<u>Accumulated sediments or trash impair free flow of water into system</u>	<u>Inlet should be free of obstructions allowing free distributed flow of water into system</u>
	<u>B</u>	<u>Pipe damage or blockage</u>	<u>Pipe damaged or otherwise not functioning properly</u>	<u>Pipe is repaired and allowing free flow of water into system</u>
<u>Pre-Treatment Chamber</u>	<u>B</u>	<u>Sediment accumulation</u>	<u>Sediment accumulation in the pre-treatment chamber</u>	<u>Sediment removed from the pre-treatment chamber</u>
	<u>B</u>	<u>Access cover damage or difficulty opening</u>	<u>Access cover (manhole cover/grate) is damaged or cannot be opened using normal lifting pressure</u>	<u>Access cover is repaired and can be opened using normal lifting pressure.</u>

No. 22 - Proprietary Technology Modular Wetland System				
Maintenance Component	Recommended Inspection Frequency^{1,2}	Defect or Problem	Condition When Maintenance is Needed	Results Expected When Maintenance is Performed
<u>Pre-Treatment Chamber (continued)</u>	<u>B</u>	<u>Obstruction or clogging of screening device</u>	<u>Contaminants and pollutants collected by screen are obstructing flow of water into the system</u>	<ul style="list-style-type: none"> • <u>All pollutants removed and disposed of according to applicable regulations</u> • <u>Screen is free of obstructions and allows free flow of water into system</u>
	<u>B</u>	<u>Accumulated pollutants or debris in separation chamber</u>	<u>Accumulated pollutants or debris impedes function of unit</u>	<u>All pollutants removed and disposed of according to applicable regulations</u>
<u>Filter Media</u>	<u>A</u>	<u>Life cycle</u>	<u>Regular interval replacement due to typical average life of product or clogging</u>	<u>Old filter media is removed and new filter media is installed</u>
<u>Structure</u>	<u>A</u>	<u>Unit shows signs of structural deterioration</u>	<ul style="list-style-type: none"> • <u>Visible cracks wider than ½ inch</u> • <u>Evidence of soil particles entering the structure through the cracks</u> • <u>Damage to frame</u> 	<u>Structure is sealed and structurally sound</u>
<u>Access Cover</u>	<u>A</u>	<u>Hard to open</u>	<u>Cannot be easily opened</u>	<u>Access lid is repaired or replaced</u>
	<u>A</u>	<u>Buried</u>	<u>Buried</u>	<u>Access lid functions as designed (refer to record drawings for design intent)</u>
	<u>A</u>	<u>Missing cover</u>	<u>Cover missing</u>	<u>Cover replaced</u>
<u>Vegetation</u>	<u>B</u>	<u>Plants not growing or in poor condition</u>	<ul style="list-style-type: none"> • <u>Soil/mulch too wet</u> • <u>Evidence of spill</u> • <u>Incorrect plant selection</u> • <u>Pest infestation</u> • <u>Vandalism to plants</u> 	<u>Plants should be healthy and pest free.</u>

No. 22 - Proprietary Technology Modular Wetland System				
Maintenance Component	Recommended Inspection Frequency^{1,2}	Defect or Problem	Condition When Maintenance is Needed	Results Expected When Maintenance is Performed
<u>Vegetation (continued)</u>	<u>B</u>	<u>Excessive plant growth</u>	<u>Excessive plant growth inhibits facility function or becomes a hazard for pedestrian and vehicular circulation and safety</u>	<ul style="list-style-type: none"> • <u>Pruning and/or thinning vegetation maintains proper plant density</u> • <u>Appropriate plants are present</u>

¹ Inspection frequency:

A = Annually; B = Biannually; M = Monthly; E = Recommend that additional inspections be performed as appropriate after major events (e.g., >1 inch of precipitation in 24 hours or environmental incident that causes contaminant release; Q = Quarterly (four times per year); W = Recommend that at least one inspection occur during the wet season, preferably after trees have lost their leaves

² Inspection frequencies provided are recommendations only. Proprietary technologies shall be inspected on a frequency as recommended by the manufacturer.

No. 2322 - Bioretention Facilities				
Maintenance Component	Recommended Inspection Frequency ¹	Defect or Problem	Conditions When Maintenance is Needed	Results Expected When Maintenance is Performed
Facility – General Requirements	B, E	Pests: Insects/Rodents	Pest of concern is present and impacting facility function	<ul style="list-style-type: none"> • Pests removed or destroyed and facility returned to original functionality • Do not use pesticides or <i>Bacillus thuringiensis israelensis (Bti)</i>
	A, E	Trash	Trash and debris present	No trash and debris present
	B, E	Contaminants and pollution	Any evidence of contaminants or pollution such as oil, gasoline, concrete slurries, or paint	<ul style="list-style-type: none"> • Materials removed and disposed of according to applicable regulations • Source control BMPs implemented if appropriate • No contaminants present other than a surface oil film
Earthen Side Slopes and Berms	B, E	Erosion	Erosion (gullies/rills) greater than 2 inches deep around inlets, outlet, and alongside slopes	<ul style="list-style-type: none"> • Cause of erosion is eliminated • Damaged area is stabilized (regrade, rock, vegetation, erosion control blanket) <p>For deep channels or cuts (over 3 inches in ponding depth), temporary erosion control measures are in place until permanent repairs can be made.</p>
			Erosion of sides causes slope to become a hazard	The hazard is eliminated and slopes are stabilized
	A, E	Settlement	Settlement greater than 3 inches (relative to undisturbed sections of berm)	The design height is restored with additional mulch

No. 2322 - Bioretention Facilities				
Maintenance Component	Recommended Inspection Frequency ¹	Defect or Problem	Conditions When Maintenance is Needed	Results Expected When Maintenance is Performed
Earthen Side Slopes and Berms (continued)	A, E	Berm leakage	Downstream face of berm wet, seeps or leaks evident	Holes are plugged and berm is compacted (may require consultation with licensed engineer, particularly for larger berms)
			Any evidence of rodent holes or water piping in berm	<ul style="list-style-type: none"> • Rodents (refer to "Pests: Insects/Rodents") removed or destroyed • Berm repaired/compact ed
Concrete Sidewalls	A	Cracks	Rot, cracks, or failure of concrete sidewalls	Concrete is repaired or replaced
Rockery Sidewalls	A	Instable rockery	Rockery side walls are insecure	Rockery sidewalls are stable (may require consultation with licensed engineer, particularly for walls 4 feet or greater in height)
Facility Bottom Area	B	Sediment accumulation	Accumulated sediment to extent that infiltration rate is reduced (refer to "Bioretention Soil") or surface storage capacity significantly impacted	<ul style="list-style-type: none"> • Sediment cleaned out to restore facility shape and depth • Damaged vegetation is replaced and mulched • Source of sediment identified and controlled (if feasible)
	B	Leaf accumulation	Accumulated leaves in facility	No leaves clogging outlet structure or impeding water flow
Check Dams and Weirs	A, E	Sediment, vegetation, or debris accumulation	Sediment, vegetation, or debris accumulated at or blocking (or having the potential to block) check dam, flow control weir, or orifice	Blockage is cleared

No. 2322 - Bioretention Facilities				
Maintenance Component	Recommended Inspection Frequency ¹	Defect or Problem	Conditions When Maintenance is Needed	Results Expected When Maintenance is Performed
Check Dams and Weirs (continued)	A, E	Erosion	Erosion and/or undercutting present	<ul style="list-style-type: none"> No eroded or undercut areas in bioretention facility Cause of erosion or undercutting addressed Check dam or weir is repaired
	A	Unlevel top of weir	Grade board or top of weir damaged or not level	Weir restored to level position
Bioretention Soil	As needed	Ponded water	Water remains in the basin 48 hours or longer after the end of a storm	Cause of ponded water is identified and addressed: <ol style="list-style-type: none"> Leaf litter/debris is removed Underdrain is clear Other water inputs (e.g., groundwater, illicit connections) investigated Contributing area verified and facility size is evaluated If items #1–4 do not solve the problem, imported bioretention soil is replaced and replanted.
	As needed	Protection of soil	Maintenance will occur requiring entrance into the facility footprint	Maintenance is performed without compacting bioretention soil media
Splash Block Inlet	B	Water not properly directed to facility	Water is not being directed properly to the facility and away from the inlet structure	Blocks are reconfigured to direct water to facility and away from structure
Curb Cut Inlet/Outlet	A, E	Accumulated debris	Accumulated leaves, sediment, debris or vegetation at curb cuts	<ul style="list-style-type: none"> Blockage is cleared Source of the blockage is identified and action is taken to prevent future blockages

No. 2322 - Bioretention Facilities				
Maintenance Component	Recommended Inspection Frequency ¹	Defect or Problem	Conditions When Maintenance is Needed	Results Expected When Maintenance is Performed
Inlet/Outlet Pipe	A	Damaged pipe	Pipe is damaged	<ul style="list-style-type: none"> • Pipe is repaired/replaced • No cracks more than ¼-inch wide at the joint of inlet/outlet pipes exist
	A	Clogged pipe	Pipe is clogged	Pipe is clear
	A, E	Accumulated debris	Accumulated leaves, sediment, debris or vegetation at inlet or outlet pipe	<ul style="list-style-type: none"> • Pipe is clear of debris • Source of the blockage is identified and action is taken to prevent future blockages
	A, E	Blocked access	Maintain access for inspections	<ul style="list-style-type: none"> • Vegetation is cleared within 1 foot of inlets and outlets • Access pathways are maintained
	B	Erosion	Water disrupts soil media	<ul style="list-style-type: none"> • No eroded or scoured areas in bioretention facility • Cause of erosion or scour addressed. • Pipes or splash blocks are reconfigured or repaired • A cover of rock or cobbles or other erosion protection measure maintained (e.g., matting) to protect the ground where concentrated water enters or exits the facility (e.g., a pipe, curb cut or swale)
Overflow	A, E	Blocked overflow	Capacity reduced by sediment or debris	No sediment or debris in overflow

No. 2322 - Bioretention Facilities				
Maintenance Component	Recommended Inspection Frequency¹	Defect or Problem	Conditions When Maintenance is Needed	Results Expected When Maintenance is Performed
Underdrain Pipe	A	Blocked underdrain	<ul style="list-style-type: none"> Plant roots, sediment or debris reducing capacity of underdrain Prolonged surface ponding (refer to "Bioretention Soil") 	Underdrains and orifice are free of sediment and debris
Facility Bottom Area and Upland Slope Vegetation	M	Lack of vegetation	Vegetation survival rate falls below 75 percent within first 2 years of establishment (unless project O&M manual or record drawing stipulates more or less than 75 percent survival rate)	<ul style="list-style-type: none"> Plants are healthy and pest free Cause of poor vegetation growth addressed Bioretention facility is replanted as necessary to obtain 75 percent survival rate or greater Plant selection is appropriate for site growing conditions
Trees and Shrubs	A	Causing problems for operation of facility	Large trees and shrubs interfere with operation of the facility or access for maintenance	Trees and shrubs do not hinder facility performance or maintenance activities
	A	Dead trees or shrubs	Standing dead vegetation is present	<ul style="list-style-type: none"> Trees and shrubs do not hinder facility performance or maintenance activities Dead vegetation is removed Cause of dead vegetation is addressed Specific plants with high mortality rate are replaced with more appropriate species

No. <u>2322</u> - Bioretention Facilities				
Maintenance Component	<u>Recommended Inspection Frequency</u> ¹	Defect or Problem	Conditions When Maintenance is Needed	Results Expected When Maintenance is Performed
Trees and Shrubs Adjacent to Vehicle Travel Areas (or areas where visibility needs to be maintained)	<u>A</u>	Safety issues	Vegetation causes some visibility (line of sight) or driver safety issues	<ul style="list-style-type: none"> • Appropriate height for sight clearance is maintained • Regular pruning maintains visual sight lines for safety or clearance along a walk or drive • Tree or shrub is removed or transplanted if presenting a continual safety hazard
Emergent Vegetation	<u>M</u>	Conveyance blocked	Vegetation compromises conveyance	Sedges and rushes are clear of dead foliage
Noxious Weeds	<u>M (March – October)</u>	Presence of noxious weeds	Any noxious or nuisance vegetation which may constitute a hazard to City personnel or the public	<ul style="list-style-type: none"> • Noxious and nuisance vegetation removed according to applicable regulations • No danger of noxious vegetation where City personnel or the public might normally be
Excessive Vegetation	<u>M</u>	Adjacent facilities compromised	Low-lying vegetation growing beyond facility edge onto sidewalks, paths, or street edge poses pedestrian safety hazard or may clog adjacent permeable pavement surfaces due to associated leaf litter, mulch, and soil	<ul style="list-style-type: none"> • Vegetation does not impede function of adjacent facilities or pose as safety hazard • Groundcovers and shrubs trimmed at facility edge • Excessive leaf litter is removed.

No. 2322 - Bioretention Facilities				
Maintenance Component	Recommended Inspection Frequency¹	Defect or Problem	Conditions When Maintenance is Needed	Results Expected When Maintenance is Performed
Excessive Vegetation (continued)	M	Causes facility to not function properly	Excessive vegetation density inhibits stormwater flow beyond design ponding or becomes a hazard for pedestrian and vehicular circulation and safety	<ul style="list-style-type: none"> Pruning and/or thinning vegetation maintains proper plant density and aesthetics Plants that are weak, broken, or not true to form are removed or replaced in-kind Appropriate plants are present
Mulch	A	Lack of mulch	Bare spots (without mulch cover) are present or mulch depth less than 2 inches	<ul style="list-style-type: none"> Facility has a minimum 3-inch layer of an appropriate type of mulch Mulch is kept away from woody stems
Plant Watering	Weekly or as required (May – September)	Plant establishment	Plant establishment period (1–3 years)	Plants are watered as necessary during periods of no rain to ensure plant establishment
Summer Watering (after establishment)	Weekly or as required (May – September)	Drought period	Established vegetation (after 3 years)	<ul style="list-style-type: none"> Plants are watered as necessary during drought conditions Trees are watered up to 5 years after planting

¹ [Inspection frequency:](#)

[A = Annually; B = Biannually; M = Monthly; E = Recommend that additional inspections be performed as appropriate after major events \(e.g., >1 inch of precipitation in 24 hours or environmental incident that causes contaminant release; Q = Quarterly \(four times per year\); W = Recommend that at least one inspection occur during the wet season, preferably after trees have lost their leaves](#)

No. 2423 - Cisterns				
Maintenance Component	Recommended Inspection Frequency¹	Defect or Problem	Conditions When Maintenance Is Needed	Results Expected When Maintenance Is Performed
Roof	B	Debris accumulation in cistern	Debris has accumulated	No debris in cistern
Gutter	B	Debris accumulation in cistern	Debris has accumulated	No debris in cistern or gutter
Screens at the Top of Downspout and Cistern Inlet	A	Debris accumulation in cistern	Screen has deteriorated or is missing	Screen is in place and functions as designed
	Monthly (October – April), E		Preventative maintenance	No debris in cistern or accumulated on screen
Overflow Pipe	B	Damaged	Pipe is cracked, joints and fittings not sealed	Overflow pipe is watertight and does not leak.
	B	Discharge is sporadic, cistern overtops	Debris has accumulated blocking flow	Overflow pipe can convey overflow to point of discharge.
Cistern	A	Accumulated debris and/or sediment	More than 6 inches of accumulation in bottom of cistern	Accumulation of debris and/or sediment removed
Low Flow Orifice (detention cistern)	M (October – April), E	Cistern overflows are too frequent	Debris or other obstruction of orifice	Orifice is clear
Delivery and Distribution System (harvesting)	Varies	None – ongoing maintenance activity	Ongoing maintenance (e.g., replacing and/or cleaning filters, removing sediment and other pollutants from storage systems)	Manufacturer's, installer's, or designer's instructions for O&M are followed
Access and Safety	Ongoing	None – ongoing maintenance activity	Access to cistern required for maintenance or cleaning	Any cistern opening that could allow the entry of people is marked: "DANGER—CONFINED SPACE"
Pests	B	Mosquito infestation	Standing water remains for more than 3 days following storms	<ul style="list-style-type: none"> All inlets, overflows and other openings are protected with mosquito screens No mosquito infestation present

¹ [Inspection frequency:](#)

[A = Annually; B = Biannually; M = Monthly; E = Recommend that additional inspections be performed as appropriate after major events \(e.g., >1 inch of precipitation in 24 hours or environmental incident that causes contaminant release; Q = Quarterly \(four times per year\); W = Recommend that at least one inspection occur during the wet season, preferably after trees have lost their leaves](#)

No. 2524 - Downspout, Sheet Flow, and Concentrated Dispersion Systems				
Maintenance Component	Recommended Inspection Frequency ¹	Defect or Problem	Conditions When Maintenance Is Needed	Results Expected When Maintenance Is Performed
Splash Block	B	Water directed toward building	Water is being directed towards building structure	Blocks direct water away from building structure
	B	Water causing erosion	Water disrupts soil media	Blocks are reconfigured/repared and media is restored
Transition Zone	B, E	Erosion	Adjacent soil erosion; uneven surface creating concentrated flow discharge; or less than 2 foot of width	No eroded or scoured areas Cause of erosion or scour is addressed
Dispersion Trench	B	Concentrated flow	Visual evidence of water discharging at concentrated points along trench (normal condition is a "sheet flow" from edge of trench; intent is to prevent erosion damage)	No debris on trench surface Notched grade board or other distributor type is aligned to prevent erosion Trench is rebuilt to standards, if necessary
Surface of Trench	A, E	Accumulated debris	Accumulated trash, debris, or sediment on drain rock surface impedes sheet flow from facility	Trash or debris is removed/disposed in accordance with local solid waste requirements
	A, E	Vegetation impeding flow	Vegetation/moss present on drain rock surface impedes sheet flow from facility	Freely draining drain rock surface
Pipe(s) to Trench	A	Accumulated debris in drains	Accumulation of trash, debris, or sediment in roof drains, gutters, driveway drains, area drains, etc.	No trash or debris in roof drains, gutters, driveway drains, or area drains
	A	Accumulated debris in inlet pipe	Pipe from sump to trench or drywell has accumulated sediment or is plugged	No sediment or debris in inlet/outlet pipe screen or inlet/outlet pipe
	A	Damaged pipes	Cracked, collapsed, broken, or misaligned drain pipes	No cracks more than ¼-inch wide at the joint of the inlet/outlet pipe

No. 2524 - Downspout, Sheet Flow, and Concentrated Dispersion Systems				
Maintenance Component	Recommended Inspection Frequency ¹	Defect or Problem	Conditions When Maintenance Is Needed	Results Expected When Maintenance Is Performed
Sump		Accumulated sediment	Sediment in the sump	Sump contains no sediment
Access Lid		Hard to open	Cannot be easily opened	Access lid is repaired or replaced
		Buried	Buried	Access lid functions as designed (refer to record drawings for design intent)
		Missing cover	Cover missing	Cover replaced
Rock Pad (concentrated flow dispersion)	A	Inadequate rock cover	Only one layer of rock exists above native soil in area 6 square feet or larger, or any exposure of native soil	Rock pad is repaired/replaced to meet design standards
	A	Erosion	Soil erosion in or adjacent to rock pad	Rock pad is repaired/replaced to meet design standards
Dispersal Area (general)	A	Erosion	Erosion (gullies/rills) greater than 2 inches deep in dispersal area	No eroded or scoured areas Cause of erosion or scour is addressed
	A	Accumulated sediment	Accumulated sediment or debris to extent that blocks or channelizes flow path	No excess sediment or debris in dispersal area. Sediment source is addressed (if feasible)
Ponded Water	As needed	Ponded water	Standing surface water in dispersion area remains for more than 3 days after the end of a storm event	<ul style="list-style-type: none"> • System freely drains • Standing water in dispersion area does not persist for more than 3 days after a storm event • Cause of the standing water (e.g., grade depressions, compacted soil) addressed

No. 2524 - Downspout, Sheet Flow, and Concentrated Dispersion Systems				
Maintenance Component	Recommended Inspection Frequency ¹	Defect or Problem	Conditions When Maintenance Is Needed	Results Expected When Maintenance Is Performed
Vegetation	M	Plant survival	Dispersal area vegetation in establishment period (1–2 years, or additional 3rd year) during extreme dry weather)	Vegetation healthy and watered weekly during periods of no rain to ensure plant establishment
Vegetation (continued)	M	Lack of vegetation allowing erosion	Poor vegetation cover such that erosion is occurring	<ul style="list-style-type: none"> • Vegetation healthy and watered. • No eroded or scoured areas present • Cause of erosion or scour addressed • Plant species appropriate for the soil and moisture conditions
	M	Vegetation blocking flow	Vegetation inhibits dispersed flow along flow path	Vegetation is trimmed, weeded, or replanted to restore dispersed flow path
	M (March – October)	Presence of noxious weeds	Any noxious or nuisance vegetation which may constitute a hazard to City personnel or the public	<ul style="list-style-type: none"> • Noxious and nuisance vegetation removed according to applicable regulations • No danger of noxious vegetation where City personnel or the public might normally be
Sump	A	Accumulated sediment	Accumulated sediment in the sump exceeds 30 percent of storage volume	No sediment in sump or inlet/outlet pipes
Access Lid	A	Hard to open	Cannot be easily opened	Access lid is repaired or replaced
	A	Buried	Buried	Access lid functions as designed (refer to record drawings for design intent)
	A	Missing cover	Cover missing	Cover replaced

No. 2524 - Downspout, Sheet Flow, and Concentrated Dispersion Systems				
Maintenance Component	Recommended Inspection Frequency ¹	Defect or Problem	Conditions When Maintenance Is Needed	Results Expected When Maintenance Is Performed
Pest Control	B	Mosquito infestation	Standing surface water in dispersion area remains for more than 3 days after the end of a storm	<ul style="list-style-type: none"> • System freely drains • Standing water in dispersion area does not persist for more than 3 days after a storm event • Cause of the standing water (e.g., grade depressions, compacted soil) addressed
Rodents	As required	Presence of rodents	Rodent holes or mounds disturb dispersion flow paths	<ul style="list-style-type: none"> • Rodents removed or destroyed • Holes filled • Flow path revegetated

¹ [Inspection frequency:](#)

[A = Annually; B = Biannually; M = Monthly; E = Recommend that additional inspections be performed as appropriate after major events \(e.g., >1 inch of precipitation in 24 hours or environmental incident that causes contaminant release; Q = Quarterly \(four times per year\); W = Recommend that at least one inspection occur during the wet season, preferably after trees have lost their leaves](#)

No. 2625 - Permeable Pavement ¹				
Maintenance Component	Recommended Inspection Frequency²	Defect or Problem	Conditions When Maintenance Is Needed	Results Expected When Maintenance Is Performed
Facility – General Requirements	A	Unstable adjacent area	Runoff from adjacent pervious areas deposits soil, mulch or sediment on paving	<ul style="list-style-type: none"> • No deposited soil or other materials on permeable pavement or other adjacent surfacing • All exposed soils that may erode to pavement surface mulched and/or planted
	A	Wearing course covered by adjacent vegetation	Vegetation growing beyond facility edge onto sidewalks, paths, and street edge	<ul style="list-style-type: none"> • Vegetation does not impede function of adjacent facilities or pose as safety hazard • Groundcovers and shrubs trimmed to avoid overreaching the sidewalks, paths and street edge
	A, E	Contaminants and pollution	Any evidence of contaminants or pollution such as oil, gasoline, concrete slurries, or paint	<ul style="list-style-type: none"> • Materials removed and disposed of according to applicable regulations • Source control BMPs implemented if appropriate • No contaminants present other than a surface oil film
Pavement Wearing Course (all types)	A	Accumulated sediment on surface	Sediment present at the surface of the pavement	Sediment at surface does not inhibit infiltration
	A	Surface clogged by moss	Moss growth inhibits infiltration or poses slip safety hazard	Moss growth on surface does not inhibit infiltration or present a slip safety hazard

No. 2625 - Permeable Pavement ¹				
Maintenance Component	Recommended Inspection Frequency ²	Defect or Problem	Conditions When Maintenance Is Needed	Results Expected When Maintenance Is Performed
Pavement Wearing Course (all types)	A	Surface is clogged	Ponding on surface or water flows off the permeable pavement surface during a rain event (does not infiltrate)	<ul style="list-style-type: none"> • System drains freely • No standing water on surface between storms
	A	Settlement	When deviation from original grade impedes function.	Original grade re-established
Permeable Asphalt or Cement Concrete	A	Cracks	Major cracks or trip hazards and concrete spalling and raveling	<ul style="list-style-type: none"> • Potholes or small cracks filled with patching mixes • Large cracks and settlement addressed by cutting and replacing the pavement section
Permeable Paver or Open-Celled Paving Grid	A	Paver block missing or damaged	Paver block missing or damaged	Individual damaged paver blocks removed and replaced or repaired per manufacturer's recommendations
	A	Loss of aggregate material between paver blocks	Loss of aggregate material between paver blocks	Aggregate replaced per manufacturer's recommendations
Open-Celled Paving Grid	A	Paving grid missing or damaged	Three or more adjacent rings in paving grid missing or damaged	Grid segment replaced or repaired per manufacturer's recommendations
	A	Loss of aggregate material in paving grid OR Lack of grass coverage	Loss of aggregate material in paving grid	Aggregate gravel level maintained at the same level as the plastic rings or no more than ¼ inch above the top of rings
	A	Lack of grass coverage	Poor grass coverage in paving grid	<ul style="list-style-type: none"> • Growing medium restored • Facility reseeded or planted • Aerated • Vegetated area amended as needed

No. 2625 - Permeable Pavement ¹				
Maintenance Component	Recommended Inspection Frequency ²	Defect or Problem	Conditions When Maintenance Is Needed	Results Expected When Maintenance Is Performed
Open-Celled Paving Grid (continued)	A	Weeds present	Weeds present	Weeds are removed if infiltration is hindered. Noxious weeds are removed.
Inlet/Outlet Pipe	A	Pipe is damaged	Pipe is damaged	Pipe is repaired/replaced
	A	Pipe is clogged	Pipe is clogged	Roots or debris is removed
	A, E	Erosion	Native soil exposed or other signs of erosion damage present	<ul style="list-style-type: none"> • No eroded or scoured areas • Cause of erosion or scour is addressed
Underdrain Pipe	B	Blocked underdrain	Plant roots, sediment or debris reducing capacity of underdrain (may cause prolonged drawdown period)	Underdrains and orifice free of sediment and debris

¹ Fog seal, chip seal and other impervious overlays are not permitted on top of permeable pavement.

² [Inspection frequency:](#)

[A = Annually; B = Biannually; M = Monthly; E = Recommend that additional inspections be performed as appropriate after major events \(e.g., >1 inch of precipitation in 24 hours or environmental incident that causes contaminant release; Q = Quarterly \(four times per year\); W = Recommend that at least one inspection occur during the wet season, preferably after trees have lost their leaves](#)

No. 2726 - Trees				
Maintenance Component	<u>Recommended Inspection Frequency</u>	Defect or Problem	Conditions When Maintenance Is Needed	Results Expected When Maintenance Is Performed
Tree	<u>As needed</u>	Dead or declining	Dead, damaged, or declining	Tree replaced per planting plan or acceptable substitute

No. 2827 - Vegetated Roof Systems				
Maintenance Component	Recommended Inspection Frequency¹	Defect or Problem	Conditions When Maintenance Is Needed	Results Expected When Maintenance Is Performed
Facility – General Requirements	A	Improper access and safety for maintenance	Insufficient egress/ingress routes and fall protection	<ul style="list-style-type: none"> Egress and ingress routes maintained to design standards and fire codes Fall protection is appropriate
	A	Border zone not defined	Vegetation is encroaching into border zone aggregate	<ul style="list-style-type: none"> No weeds and undesirable vegetation present Desirable vegetation transplanted
	A	Flashing, gravel stops, utilities, or other structures on roof	Flashing, utilities or other structures on roof are deteriorating (can serve as source of metal pollution in vegetated roof runoff)	Potential pollutant sources replaced or eliminated
	B	Mosquitoes	Standing water remains for more than 3 days after the end of a storm	<ul style="list-style-type: none"> System freely drains Standing water on roof does not persist for more than 3 days after a storm event
	As required	Nuisance animals	Nuisance animals causing erosion, damaging plants, or depositing large volumes of feces	Measures in place to deter nuisance species
Growth Medium	A	Water is not infiltrating properly	Water does not permeate growth media (runs off soil surface) or crusting is observed	Stormwater infiltrates freely through growth media
	A	Insufficient growth medium	Growth medium thickness is less than design thickness (due to erosion and plant uptake)	Growth medium is present at design thickness
	B, W	Fallen leaves/debris	Fallen leaves or debris are present	No leaves or debris present

No. 2827 - Vegetated Roof Systems				
Maintenance Component	Recommended Inspection Frequency ¹	Defect or Problem	Conditions When Maintenance Is Needed	Results Expected When Maintenance Is Performed
Growth Medium (continued)	A	Erosion	Growth media erosion/scour is visible (e.g., gullies)	<ul style="list-style-type: none"> No eroded or scoured areas Cause of erosion or scour addressed
Roof Drain	B, E	Not draining	Sediment, vegetation, or debris reducing capacity of inlet structure	<ul style="list-style-type: none"> Inlet clear Cause of blockage addressed
	A	Pipe is clogged	Pipe is clogged	Debris, roots, or other obstruction removed and pipe is free draining
Vegetation	B	Plant coverage	Vegetative coverage falls below 80 percent (unless design specifications stipulate less than 80 percent coverage)	<ul style="list-style-type: none"> Bare areas planted with vegetation Erosion control measures installed until percent coverage goal attained
			Summer watering – extensive vegetated roof system	Vegetation watered weekly during periods of no rain during vegetation establishment period (1–2 years)
			Summer watering – intensive vegetated roof system	Vegetation watered during drought conditions or more often if necessary to maintain plant cover during post-establishment period (after 2 years)
			Summer watering – intensive vegetated roof system	Vegetation watered deeply, but infrequently, and the top 6 to 12 inches of the root zone is moist during vegetation establishment period (1–2 years)

No. 2827 - Vegetated Roof Systems				
Maintenance Component	Recommended Inspection Frequency ¹	Defect or Problem	Conditions When Maintenance Is Needed	Results Expected When Maintenance Is Performed
Vegetation (continued)	<u>B</u>	Plant coverage (continued)	Summer watering – intensive vegetated roof system (continued)	Vegetation watered during drought conditions or more often if necessary to maintain plant cover during post-establishment period (after 2 years)
			Extensive roof with low density sedum population	Sedums are mulch mowed
	<u>A</u>	Poor plant establishment and possible nutrient deficiency in growth medium	Fertilization– extensive vegetated roof system	<ul style="list-style-type: none"> Organic debris replenished Annual soil test conducted to assess need for fertilizer Minimal amounts of slow-release fertilizer applied
			Fertilization– intensive vegetated roof system	<ul style="list-style-type: none"> Annual soil test conducted to assess need for fertilizer Minimal amounts of slow-release fertilizer applied
			Dead vegetation is present	Dead plant material recycled on the roof or removed and replaced (see manufacturer’s recommendations)
	<u>Q</u>	Weeds	Weeds are present	<ul style="list-style-type: none"> Weeds removed (manual methods preferred) IPM protocols followed

No. 2827 - Vegetated Roof Systems				
Maintenance Component	Recommended Inspection Frequency ¹	Defect or Problem	Conditions When Maintenance Is Needed	Results Expected When Maintenance Is Performed
Vegetation (continued)	M (March – October)	Noxious weeds	Any noxious or nuisance vegetation which may constitute a hazard to City personnel or the public	<ul style="list-style-type: none"> • Noxious and nuisance vegetation removed according to applicable regulations • No danger of noxious vegetation where City personnel or the public might normally be
Irrigation System (if any)	Based on manufacturer's instructions	Not applicable	Irrigation system is not working or routine maintenance needed	Manufacturer's/installer's instructions are followed for operation and maintenance

¹ [Inspection frequency:](#)

[A = Annually; B = Biannually; M = Monthly; E = Recommend that additional inspections be performed as appropriate after major events \(e.g., >1 inch of precipitation in 24 hours or environmental incident that causes contaminant release; Q = Quarterly \(four times per year\); W = Recommend that at least one inspection occur during the wet season, preferably after trees have lost their leaves](#)

No. 2928 - Rain Gardens				
Maintenance Component	Recommended Inspection Frequency ¹	Defect or Problem	Conditions When Maintenance is Needed	Results Expected When Maintenance is Performed
Facility – General Requirements	B, E	Mosquitoes	Standing water remains for more than 3 days after the end of a storm	<ul style="list-style-type: none"> • Rain garden drains freely • Standing water in rain garden does not persist for more than 3 days after a storm event • Cause of the standing water addressed (see “Ponded water”)
	A, E	Trash	Trash and debris present	No trash or debris present
Earthen Side Slopes and Berms	B, E	Erosion	Persistent soil erosion on slopes	<ul style="list-style-type: none"> • No eroded or scoured areas • Cause of erosion or scour addressed
Rockery Sidewalls	A	Unstable rockery	Rockery side walls are insecure	Stable rockery sidewalls (may require consultation with licensed engineer, particularly for walls 4 feet or greater in height)
Rain Garden Bottom Area	B	Sediment accumulation	Visible sediment deposition in the rain garden that reduces drawdown time of water in the rain garden	<ul style="list-style-type: none"> • No sediment accumulation in rain garden • Source of sediment addressed
	B	Debris accumulation	Accumulated leaves in facility	No leaves clogging outlet structure or impeding water flow
Mulch	A	Lack of mulch	Bare spots (without mulch cover) are present or mulch depth less than 2 inches	<ul style="list-style-type: none"> • Facility has a minimum 2- to 3-inch layer of an appropriate type of mulch • Mulch kept away from woody stems
Splash Block Inlet	B	Water not properly directed to rain garden	Water is being directed towards building structure	Blocks are reconfigured to direct water to rain garden and away from structure

No. 2928 - Rain Gardens				
Maintenance Component	Recommended Inspection Frequency ¹	Defect or Problem	Conditions When Maintenance is Needed	Results Expected When Maintenance is Performed
Pipe Inlet/Outlet (continued)	<u>B</u>	Erosion	Rock or cobble removed or missing and concentrated flows contacting soil	<ul style="list-style-type: none"> No eroded or scoured areas Cause of erosion or scour addressed Cover of rock or cobbles protects the ground where concentrated water flows into the rain garden
	<u>A</u>	Accumulated debris	Accumulated leaves, sediment, debris or vegetation at curb cuts, inlet or outlet pipe	Blockage cleared
	<u>A</u>	Damaged pipe	Pipe is damaged	Pipe repaired/replaced
	<u>A</u>	Clogged pipe	Pipe is clogged	Pipe clear of roots and debris
	<u>A</u>	Blocked access	Maintain access for inspections	Vegetation cleared or transplanted within 1 foot of inlets and outlets
Ponded Water	<u>As needed</u>	Ponded water	Excessive ponding water: Ponded water remains in the rain garden more than 48 hours after the end of a storm	<ul style="list-style-type: none"> Rain garden drains freely Standing water in rain garden does not persist for more than 48 hours after a storm event Leaf litter/debris/sediment removed
Overflow	<u>A, E</u>	Blocked overflow	Capacity reduced by sediment or debris	No sediment or debris in overflow
Vegetation	<u>A</u>	Blocked site distances and sidewalks	Vegetation inhibits sight distances and sidewalks	Sidewalks and sight distances along roadways and sidewalks are kept clear
	<u>A</u>	Blocked pipes	Vegetation is crowding inlets and outlets	Inlets and outlets in rain garden clear of vegetation

No. 2928 - Rain Gardens				
Maintenance Component	Recommended Inspection Frequency ¹	Defect or Problem	Conditions When Maintenance is Needed	Results Expected When Maintenance is Performed
Vegetation (continued)	M	Unhealthy vegetation	<ul style="list-style-type: none"> • Yellowing: possible Nitrogen (N) deficiency • Poor growth: possible Phosphorous (P) deficiency • Poor flowering, spotting or curled leaves, or weak roots or stems: possible Potassium (K) deficiency 	Plants are healthy and appropriate for site conditions
	M	Weeds	Presence of weeds	Weeds removed (manual methods preferred) and mulch applied
Summer Watering (years 1–3)	Weekly or as required (May – September)	Plant establishment	Tree, shrubs and groundcovers in first 3 years of establishment period	Plants are watered during plant establishment period (years 1–3)
Summer Watering (after establishment)	As needed	Drought conditions	Vegetation requires supplemental water	Plants are watered during drought conditions or more often if necessary during post-establishment period (after 2 years)

¹ [Inspection frequency:](#)

[A = Annually; B = Biannually; M = Monthly; E = Recommend that additional inspections be performed as appropriate after major events \(e.g., >1 inch of precipitation in 24 hours or environmental incident that causes contaminant release; Q = Quarterly \(four times per year\); W = Recommend that at least one inspection occur during the wet season, preferably after trees have lost their leaves](#)

This page intentionally left blank.

APPENDIX H

Financial Feasibility Documentation for Vegetated Roofs and Rainwater Harvesting

This Cover to be Replaced in PDF
with SPU-Provided Cover

Note:

Some pages in this document have been purposely skipped or blank pages inserted so that this document will copy correctly when duplexed.

Vegetated roofs and rainwater harvesting may not be financially feasible in all project situations. If the applicant determines that including a vegetated roof or rainwater harvesting to meet the on-site stormwater management requirement is not economically feasible using reasonable consideration of financial costs, even when engineering design limitations and physical limitations of the site would allow greater use of these best management practices (BMPs), then the applicant shall provide the following additional submittal documentation:

1. A narrative description and rationale with substantial evidence sufficient to explain and justify the applicant's conclusion that installation of a vegetated roof or rainwater harvesting is economically infeasible.
2. A detailed cost estimate of constructing the project as proposed (i.e., including the level of on-site stormwater management that is considered cost feasible for the project). The detailed cost estimate must include the following:
 - o Breakdown of project costs into subtotals for demolition, site preparation, building construction, site paving, landscaping, and utilities, as applicable.
 - o Itemization of the proposed stormwater control measures.
 - o If a vegetated roof or rainwater harvesting would be feasible but for cost considerations, documentation of the difference in unit and total cost between the conventional surface and rainwater harvesting and/or alternative surface approach (e.g., the difference in cost between a standard roof and associated stormwater control BMPs compared to a vegetated roof and associated stormwater control BMPs).
3. A detailed cost estimate of constructing the project with additional stormwater control BMPs beyond what the applicant considers a feasible cost (i.e., beyond the proposed design itemized in item 2 above). That is, provide the additional cost the project would incur if the project were to use a vegetated roof or rainwater harvesting to meet the on-site stormwater management requirements.
4. Building/project valuation construction cost as determined by the Seattle Department of Construction and Inspection (SDCI).
5. If applicable, Street Improvement Plan or Utility Plan construction cost as determined by the Seattle Department of Transportation (SDOT) or capital improvement project cost as determined by applicable City department.
6. If the project does not achieve the on-site stormwater management requirements and the project application is not signed and stamped by a professional engineer, a signed statement by the applicant certifying that the project design implements the on-site stormwater management requirements is required.

Alternatively, the applicant may establish financial infeasibility of rainwater harvesting based on one of the following simplified criteria:

- The non-pollution generating roof area is less than 20,000 square feet
- The ratio of roof area to average daily rainwater demand is less than 10,000 square feet/[gallons per minute \(gpm\)](#) (refer to *Volume 3, Section 5.5.1.6* for rainwater demand calculations)

This page intentionally left blank.

APPENDIX I

Landscape Management Plans and Integrated Pest Management Plans

This Cover to be Replaced in PDF
with SPU-Provided Cover

Note:

Some pages in this document have been purposely skipped or blank pages inserted so that this document will copy correctly when duplexed.

I-1. [Landscape Management Plans](#)

[A landscape management plan \(LMP\) is a plan for defining the layout and long-term maintenance of landscaping features to minimize the use of pesticides \(including herbicides and fungicides\) and fertilizers and reduce the discharge of suspended solids and other pollutants. Use of an LMP that has been approved by the City of Seattle \(City\) is allowed as an alternative to the requirement to formally treat \(with a water quality treatment BMP\) the runoff from pollution-generating pervious surfaces \(PGPS\) that are subject to water quality treatment. LMPs have the potential to significantly reduce the pollutant load washing off managed green spaces. The requirements for obtaining City approval of an LMP are summarized in this section.](#)

[LMPs must address the basic principles provided in *Volume 1, Section 7.8*, tailoring them to fit the specific site. Every LMP will not necessarily be able to apply each of the listed recommendations related to the basic principles. In addition, landscapes are managed for different purposes, some more formal than others. Some recommendations may not be appropriate for very formal sites; therefore, they will not be adopted, in favor of other management practices that better fit the intended uses of the site. In the end, the extent to which an LMP is successful depends on the ability of the applied practices to retain soil, fertilizers, and pesticides on the site and away from receiving waters throughout the entire year.](#)

[If an LMP is proposed, it must be submitted with the engineering plans for the proposed project. The following documentation is required for the evaluation of an LMP submittal:](#)

- [Site vicinity map showing topography.](#)
- [Site plan including topography, areas with saturated soils \(if applicable\), and high water tables \(if applicable\).](#)
- [Narrative describing how the basic principles in *Volume 1, Section 7.8*, will be achieved.](#)
- [Plant list \(with both common and scientific names\) that includes the following:](#)
 - [Drought-tolerant plants, disease--resistant varieties, species for attracting beneficial insects \(if any\), and native plants.](#)
 - [Proposed spacing for shrubs and groundcovers.](#)
 - [Grass mix or mixes planned for turf areas including their sun/shade tolerance, disease susceptibility, drought tolerance, and tolerance of wet soil conditions.](#)
- [Landscape plan indicating placement of landscape features, lawn areas, trees, and planting groups \(e.g., forbs, herbs, and groundcovers\) on the site.](#)
- [Signage plan including proposed locations of signs and content of signs.](#)
 - [Signage must be located to identify which areas are included in the LMP.](#)
 - [Signage must indicate how a copy of the approved LMP can be obtained.](#)
 - [Inclusion of the following information in the signage is also encouraged: basic educational information about the LMP for maintenance workers and the public.](#)

- [Information on soil preparation and fertility requirements.](#)
- [Information on the design of the irrigation method \(e.g., installed sprinkler system, drip irrigation system, or manual watering\).](#)
- [Landscape maintenance plan, including the following:](#)
 - [Physical care methods, such as thatch removal or aeration, and mowing height and frequency.](#)
 - [Type of fertilizer \(including percentages of nitrogen, phosphorus, and potassium \[N-P-K\]\) and fertilization schedule or criteria.](#)
- [Integrated Pest Management \(IPM\) plan \(refer to *Section I-2*\), including the following:](#)
 - [Type of chemicals to be used for common pests such as crane fly larvae, and the criteria or schedule for application.](#)
 - [Any biocontrol methods to be used.](#)
- [Information about the storage of pesticides or other chemicals, and the measures that will be used to dispose of them, including the following:](#)
 - [How the chemicals will be stored on the site between applications to prevent contact with stormwater or spills into the drainage system \(if applicable\).](#)
 - [How excess quantities of fertilizers or chemicals will be handled for individual applications.](#)
- [Implementation plan, including the following:](#)
 - [The responsible party for ensuring that the LMP is implemented.](#)
 - [How the applicant will ensure that grounds crews have the training and/or resources required to implement the LMP and make adjustments based on advances in landscape care practices and products.](#)
 - [A fertilizer and pesticide application log, including rate of application, area treated, and disposal or storage of residue.](#)

I-2. Integrated Pest Management Plans

An ~~Integrated Pest Management (IPM)~~ plan is a natural, long-term, ecologically based systems approach to controlling pest populations. ~~This system~~IPM uses techniques either to reduce pest populations or maintain them at levels below those causing economic injury, or to so manipulate the populations that they are prevented from causing injury.

The goals of IPM are ~~the encouragement of~~~~to encourage~~ optimal selective pesticide use (away from prophylactic, broad-spectrum use), and ~~the to maximizemaximization of~~ natural controls to minimize ~~the~~ environmental side effects by creating and maintaining healthy landscapes:

- **Design for a healthy landscape.** A landscape should be designed to maximize ~~the~~ intended uses of the land and ~~to~~ minimize potential pest problems. Design considers such plant health factors as site usage, soils, topography, hydrology and drainage, proximity to sensitive or critical areas and existing vegetation as well as known pest sensitivity. Take drainage pathways into consideration when considering landscape management and the potential need for pest control.
- **Awareness of potential pest problems.** Certain plants have known pest problems. Likewise, certain cultural conditions or landscape situations can encourage the infestation of pests.
- **Maintenance for maximum landscape health.** A well-designed and maintained landscape dramatically reduces the need for pest control. Appropriate selection of plants, pruning, proper irrigation, applications of mulch and fertilizer, appropriate mowing techniques, and other practices all promote landscapes that resist pest pressures and support natural predators.
- **Minimize disturbance of naturally occurring biological controls.** Pests have natural predators and controls operating on them at all times. Disruption of these systems ~~due to~~~~through~~ poor maintenance practices can ~~result in the development~~~~cause more~~ of new pest problems ~~to develop~~.

The ~~following~~ step-by-step comprehensive ~~Integrated Pest Management (IPM) Pp~~lan process is provided ~~below~~ as a guide.

The Integrated Pest Management Plan Process

Step 1: Correctly Identify ~~the~~~~problem~~ Pests and Understand ~~Its~~~~their~~ Life Cycle

~~Identify the pest (e.g., weed, insect, or disease).~~ Learn more about the pest. Observe it and pay attention to any damage that may be occurring. Learn about the life cycle. Many pests are ~~only~~ a problem ~~only~~ during certain seasons, or can ~~only~~ be treated effectively ~~only~~ ~~iduring~~ during certain phases of the life cycle. ~~Repeat this step if more than one pest is identified.~~

Step 2: Establish Tolerance/Action Thresholds ~~for~~ pests

Every landscape has a population of some pest (insects, weeds, ~~and~~ diseases), ~~which~~~~This~~ is good because it supports a population of beneficial species that keep pest numbers in check. Beneficial organisms may compete with, eat, or parasitize disease or pest organisms. Decide on the level of infestation that must be exceeded before treatment needs to be considered. Pest populations under this threshold should be monitored but ~~do not~~~~don't~~ need treatment.

For instance, European crane flies usually do ~~not~~ ~~cause~~ serious damage to a lawn unless there are between 25 and 40 larvae per square foot feeding on the turf in February (in normal weather years). Also, most people consider a lawn healthy and well maintained even with up to 20 percent weed cover; ~~so~~ ~~therefore~~, treatment, other than continuing good maintenance practices, is generally unnecessary.

Step 3: Monitor [Regularly to Detect and prevent Pest Problems](#)

Regular monitoring is a key practice ~~to anticipate and prevent~~ [for anticipating and preventing](#) major pest outbreaks. It begins with a visual evaluation of the lawn or landscape's condition. Take a few minutes before mowing to walk around and look for problems. Keep a notebook, record when and where a problem occurs, then monitor for it at about the same time in future years. Specific monitoring techniques can be used in the appropriate season for some potential problem pests, such as [the](#) European crane fly.

Step 4: Modify ~~the~~ Maintenance Program to Promote [Plant Healthy plants](#) and Discourage Pests

A healthy landscape is resistant to most pest problems. Lawn aeration and overseeding along with proper mowing height, fertilization, and irrigation will help the grass out-compete weeds. Correcting drainage problems and letting soil dry out between watering in the summer may reduce the number of [surviving](#) crane-fly larvae ~~that survive~~. [Gradually replace pest-prone plants.](#)

Step 5: If Pests Exceed the Tolerance Thresholds, [Use Cultural, Physical, Mechanical, or Biological Controls Prior to Implementing Chemical Controls](#)

~~Use cultural, physical, mechanical or biological controls first. If those prove insufficient, use the chemical controls described below that have the least non-target impact.~~ When a pest outbreak ~~occurs~~ ~~strikes~~ (or monitoring ~~indicates that~~ ~~shows~~ one is imminent), implement [cultural, physical, mechanical, or biological controls](#) ~~IPM~~. ~~If these types of controls prove insufficient,~~ then consider [chemical](#) control options that are the least toxic, or have the least non-target impact.

Here are two examples of an IPM approach [for damaged lawns](#):

- **Red thread disease** is most likely under low-nitrogen fertility conditions and most severe during slow growth conditions. Mow [the lawn](#) and bag the clippings to remove diseased blades. Fertilize lightly to help the grass recover, then begin grasscycling ([e.g., leaving grass clippings on a mowed lawn](#)) and change to fall fertilization with a slow release or natural organic fertilizer to provide an even supply of nutrients. Chemical fungicides are not recommended because red thread cannot kill the lawn.
- **Crane fly damage** is most prevalent on lawns that stay wet in the winter and are irrigated in the summer. Correct the winter drainage and/or allow the soil to dry between irrigation cycles; larvae are susceptible to drying out so these changes can reduce their numbers. It may also be possible to reduce [the number of](#) crane fly larvae ~~numbers~~ by using a power de-thatcher on a cool, cloudy day when ~~they are~~ ~~feeding~~ ~~is~~ ~~occurring~~ close to the surface. ~~Current~~ ~~studies~~ are [investigating the use of](#) ~~being~~

~~conducted using~~ beneficial nematodes that parasitize the crane fly larvae; this type of treatment may eventually be a reasonable alternative.

Only after trying suitable non-chemical control methods, or determining that the pest outbreak is causing too much serious damage, should chemical controls be considered. ~~Study to determine~~ ~~the available~~ ~~what~~ products ~~are available~~ and choose ~~the one~~ ~~product~~ that is the least toxic and has the least non-target impact.

Step 6: Evaluate and Record ~~the Effectiveness of the Control,~~ and Modify Maintenance ~~practices or Plant Choices~~ to Support ~~lawn or landscape~~ Recovery and Prevent Recurrence

Keep records. Note when, where, and what symptoms occurred, or when monitoring revealed a potential pest problem. Note what controls were applied and when, and the effectiveness of the control. Monitor ~~the following~~ ~~next~~ year for the same problems. Review your landscape maintenance and cultural practices to see if they can be modified to prevent or reduce ~~the severity of~~ the problem.

A comprehensive IPM program should also include the proper use of pesticides as a last resort, and vegetation/fertilizer management to eliminate or minimize the contamination of stormwater.

I-3. References

Refer to the Seattle Public Utilities IPM web page for additional resources for developing an LMP or IPM plan: www.seattle.gov/utilities/protecting-our-environment/sustainability-tips/landscaping/for-professionals/integrated-pest-management.