

- 1. Separate access to Housing and Office blocks
- 2. Developed streetscape at apartment zone
- 3. Visual barrier/security feature/restricted access by using water feature/bio-swale
- 4. Cafe at grade near Office block at NW 56th St

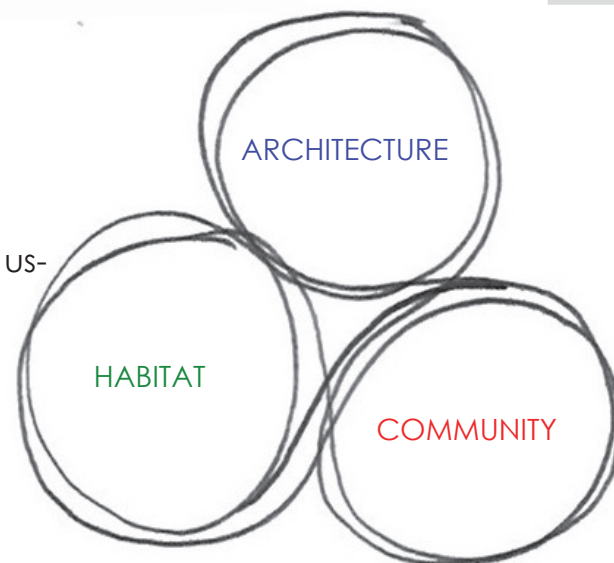

- 1. Separate access to Housing and Office blocks
- 2. Developed streetscape and landscape at apartment zone
- 3. Visual barrier/security feature using water feature/bio-swale
- 4. Cafe at grade near Office block at NW 56th St
- 5. Urban agriculture/bird habitat located at maximum solar access on site

ALTERNATIVE A

- RESIDENTIAL BLOCK (3 floors)
- > 23,040 sf residential space
 - > 7680 sf per floor (7-8 units)
 - > 7680 sf parking (24 cars)
- OFFICE BLOCK (3 floors)
- > 20,160 sf office space
 - > 6720 sf per floor
 - > 6720 sf parking (22 cars)
 - > penthouse

- PROS:
- > SIMPLE LAYOUT
 - > BEST SOUTHERN EXPOSURE FOR BUILDINGS
- CONS:
- > LESS INVITING TO THE COMMUNITY
 - > LARGE APT BLDG FOOTPRINT NOT AS EFFICIENT

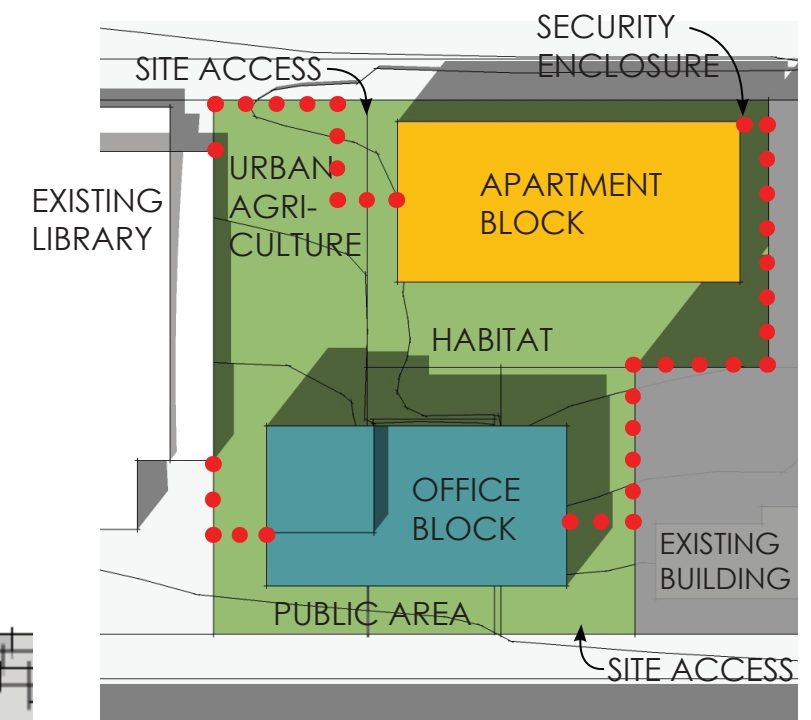
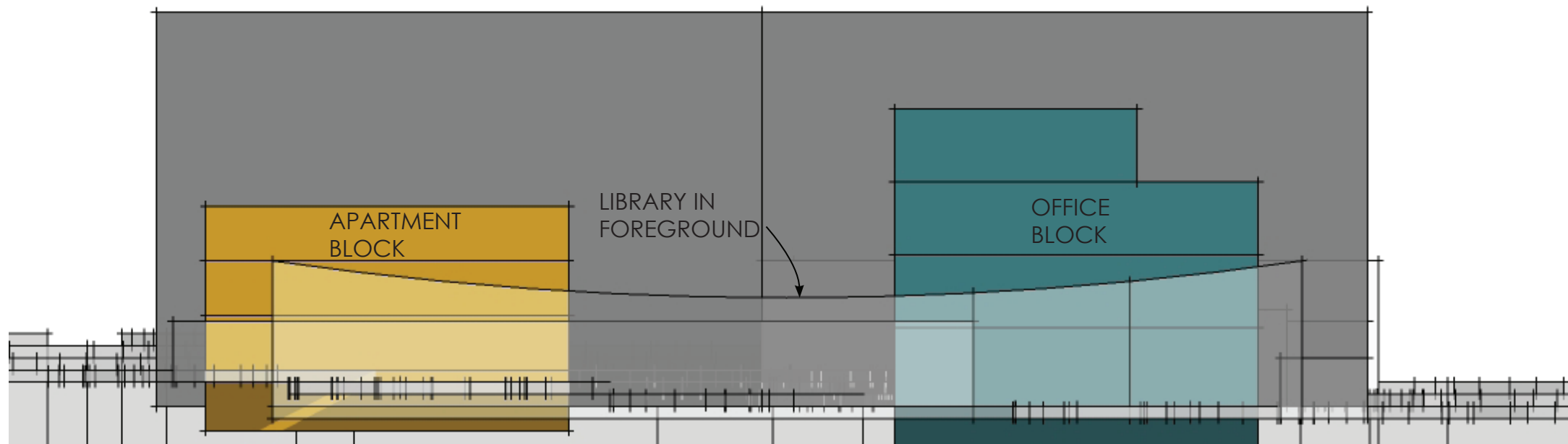
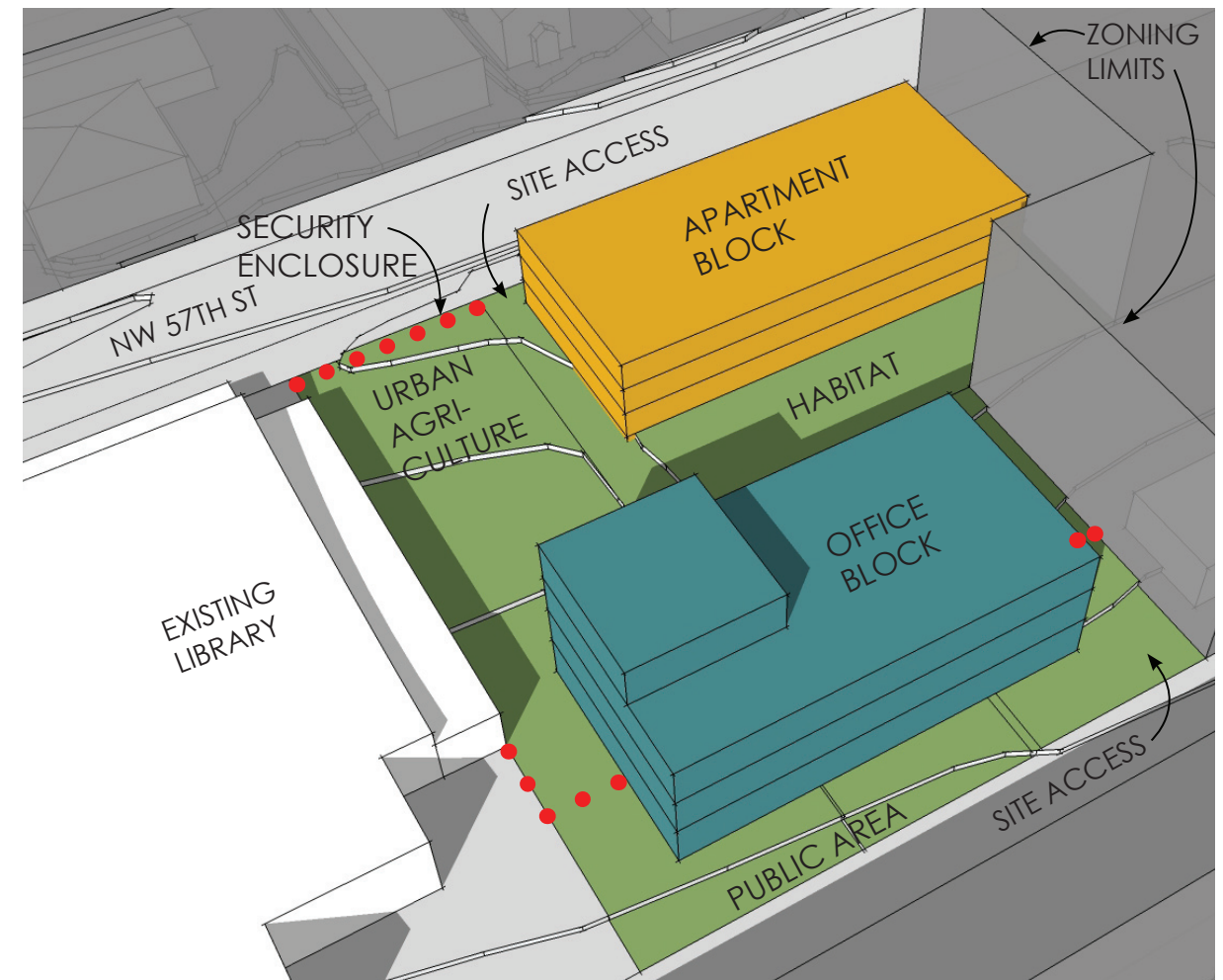
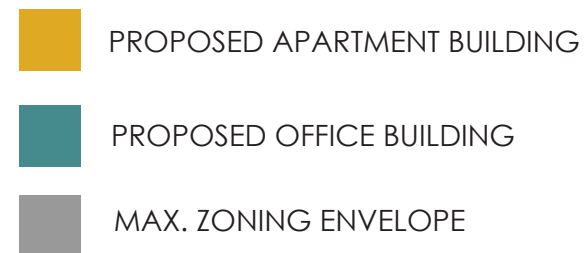

ALTERNATIVE B

- RESIDENTIAL BLOCK (3 floors)
- > 21,504 sf residential space
 - > 7168 sf per floor (7-8 units)
 - > 7168 sf parking (24 cars)
- OFFICE BLOCK (3 floors)
- > 7040 sf Office space
 - > 7040 sf parking (22 cars)
 - > penthouse

- PROS:
- > SIMPLE LAYOUT
 - > CONTIGUOUS LANDSCAPE AREA FOR HABITAT
- CONS:
- > LESS INVITING TO THE COMMUNITY
 - > LARGE APT BLDG FOOTPRINT NOT AS EFFICIENT
 - > SUN EXPOSURE FOR BUILDINGS NOT AS GOOD
 - > APARTMENT BLOCK SHADED BY OFFICE BLOCK

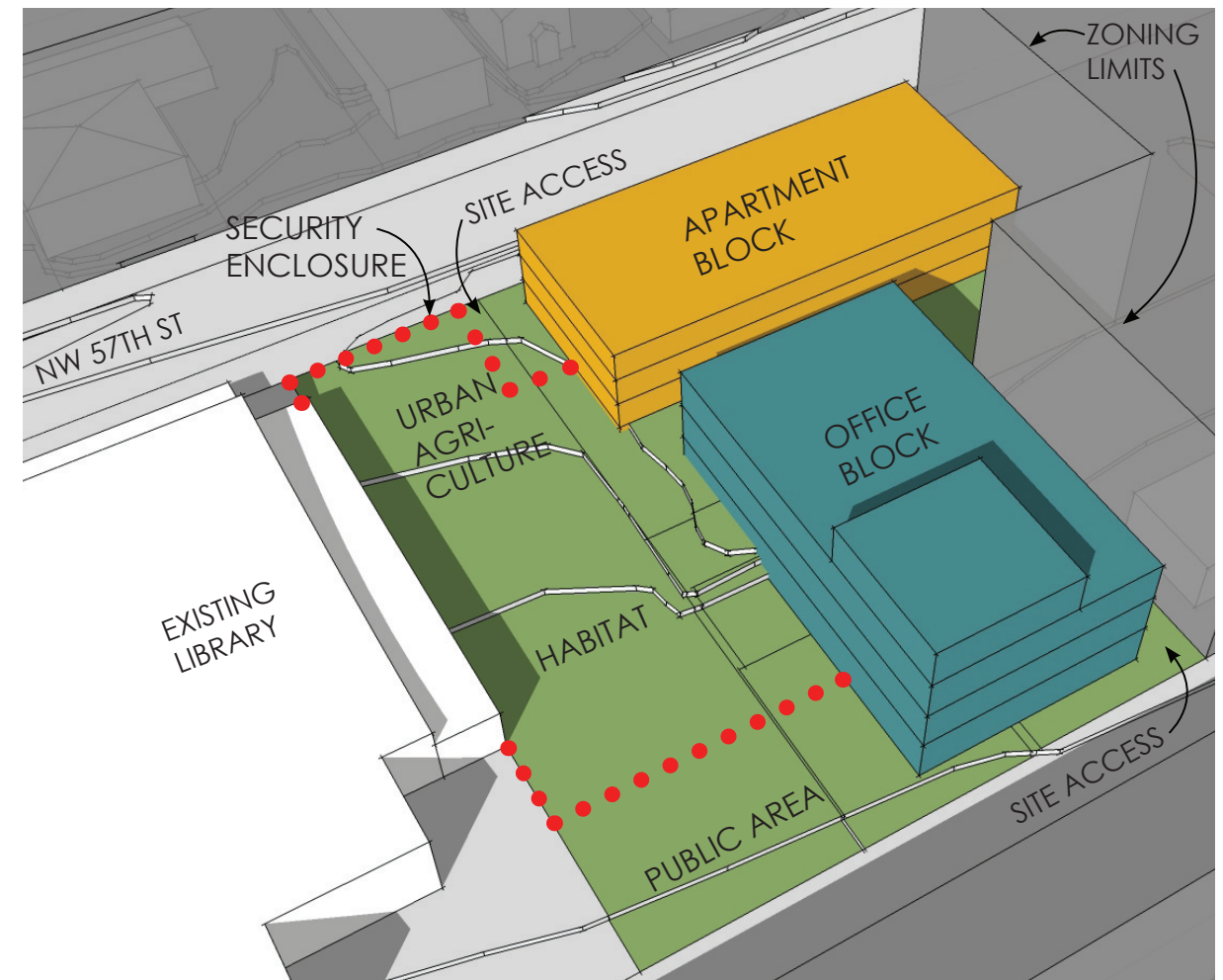
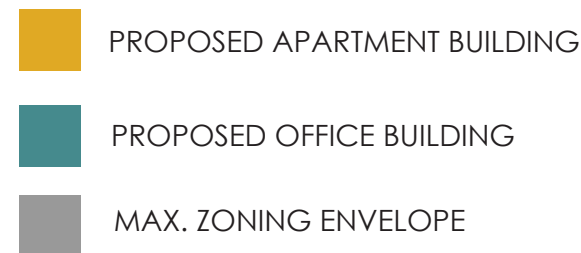

PERSPECTIVE

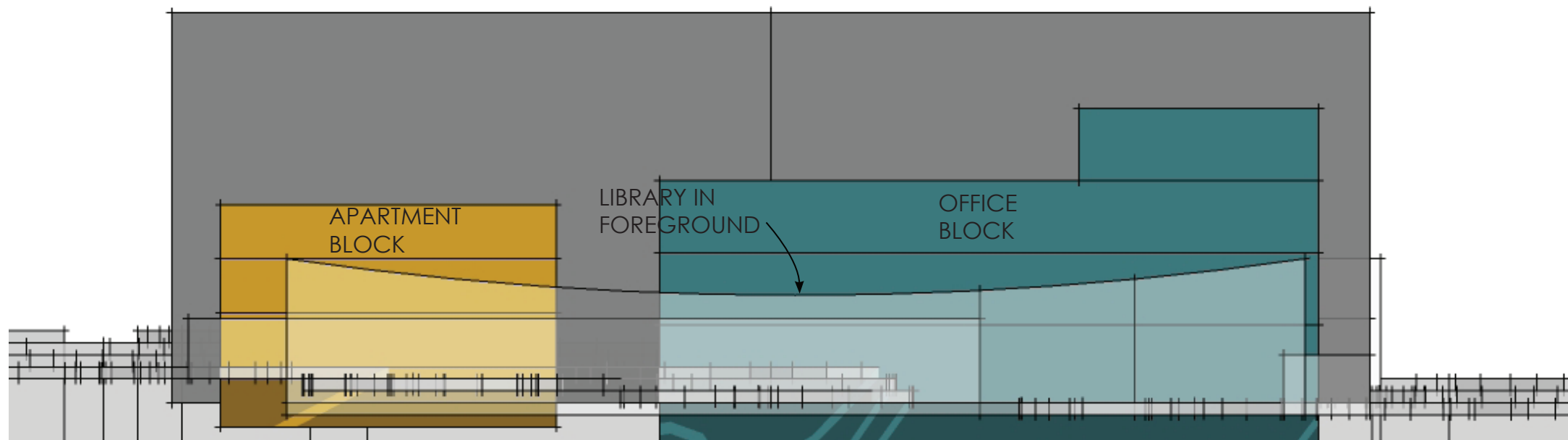

ELEVATION

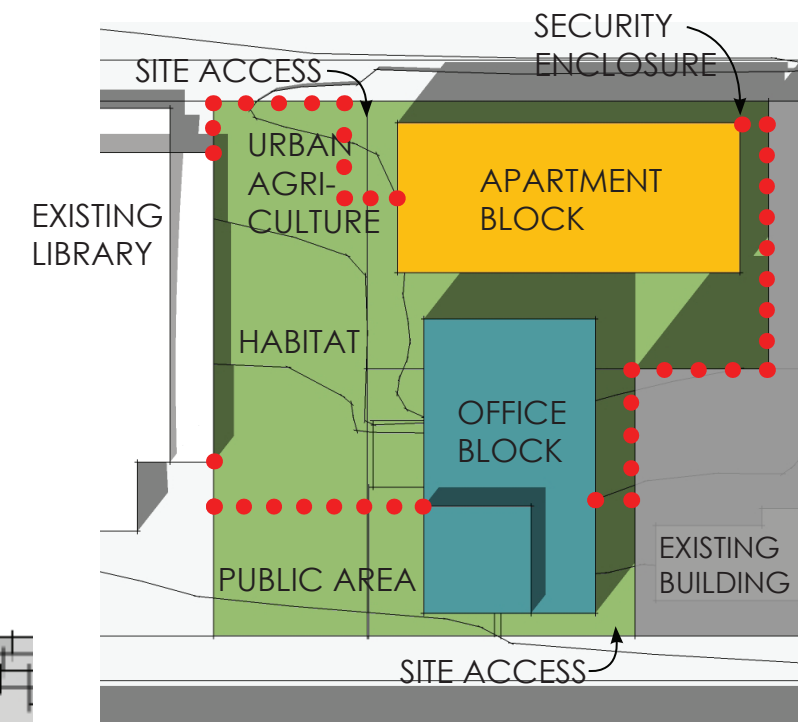

PLAN

ALTERNATIVE C (preferred)

- RESIDENTIAL BLOCK (5 floors)
- > 20,000 sf residential space
 - > 4000 sf per floor (4-5 units)
 - > 4000 sf parking (20 cars)

- OFFICE BLOCK (3 floors)
- > 21,000 sf office space
 - > 7000 sf per floor
 - > 7000 sf parking (22 cars)
 - > penthouse

- PROS:
- > SIMPLE LAYOUT
 - > PRESENTS 3 LOTS
 - > MODERATELY INVITING TO COMMUNITY
 - > TALLER, NARROWER APT BLDG IS MORE EFFICIENT
 - > LARGE CONTIGUOUS HABITAT/AGRICULTURE AREA.
- CONS:
- > LESS SOLAR EXPOSURE FOR AGRICULTURE
 - > LESS BUILDING FRONTAGE AT SIDEWALK

- PROPOSED APARTMENT BUILDING
- PROPOSED OFFICE BUILDING
- MAX. ZONING ENVELOPE

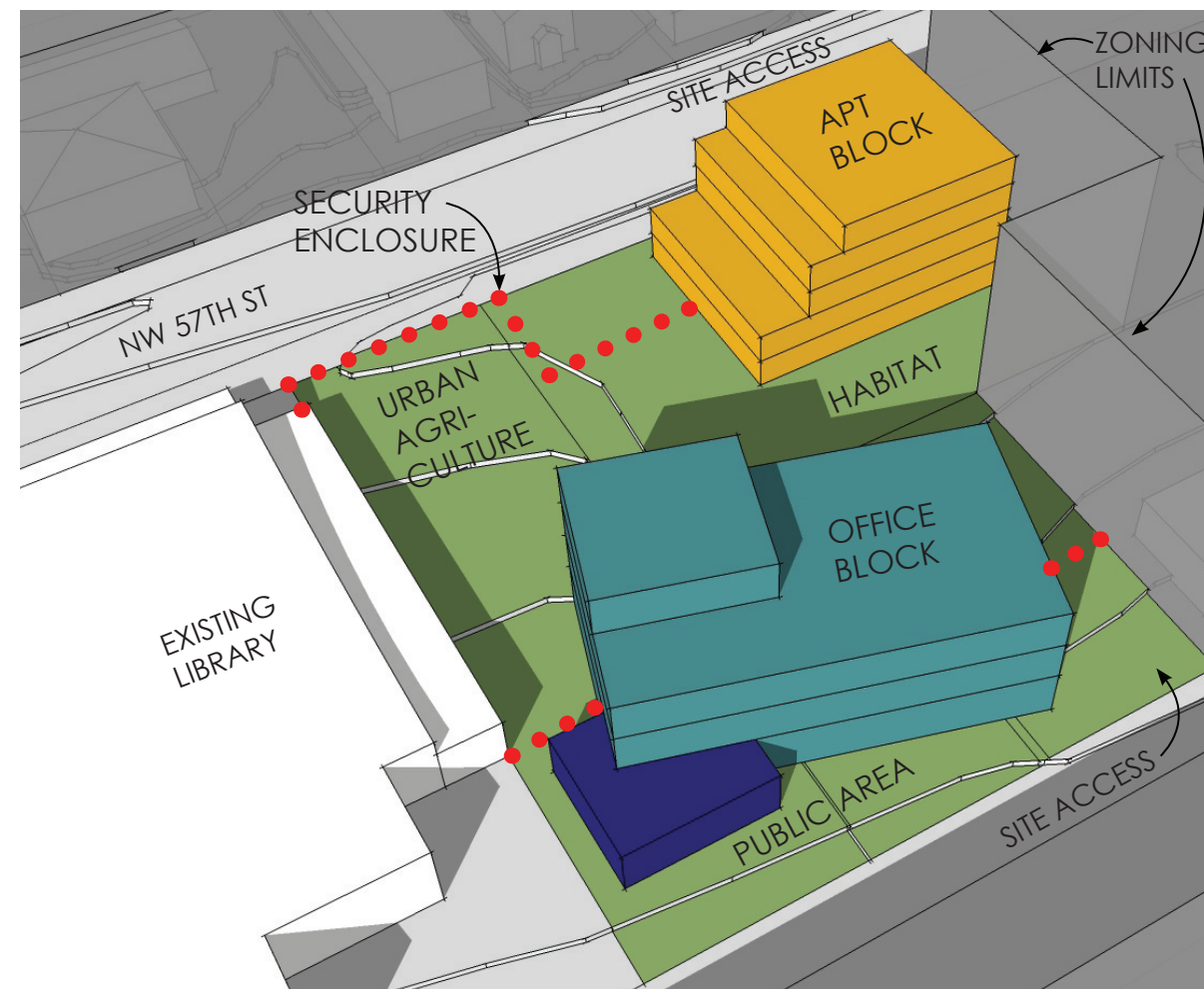

PERSPECTIVE

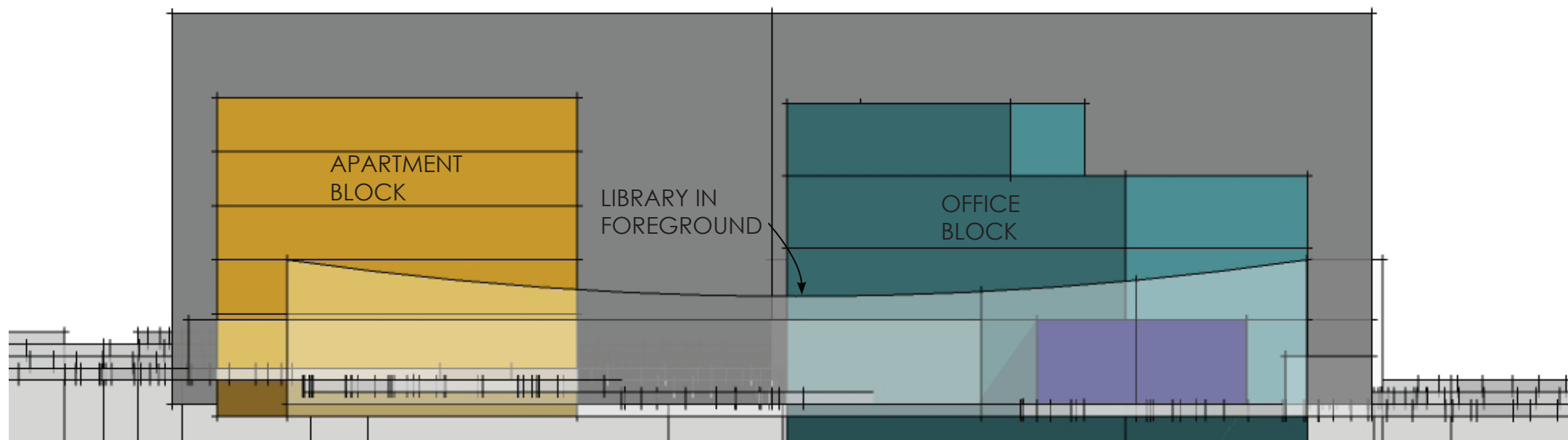

ELEVATION

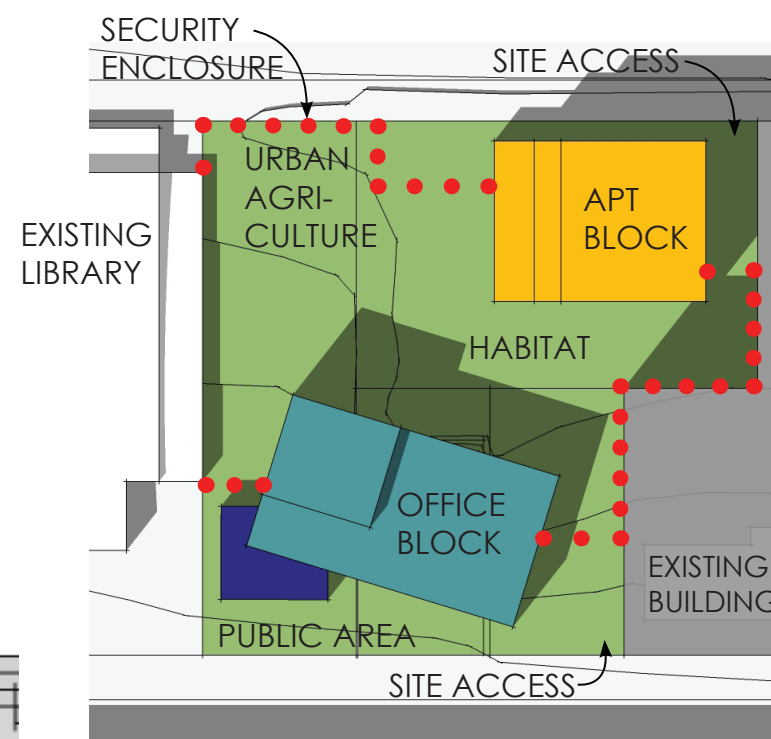

PLAN

CONCEPT EVOLUTION

STAGE 1: GENERAL MASSING

STAGE 2: STREET ARTICULATION

STAGE 3: TERRACING

OPTION 1: THE 'L'

A1

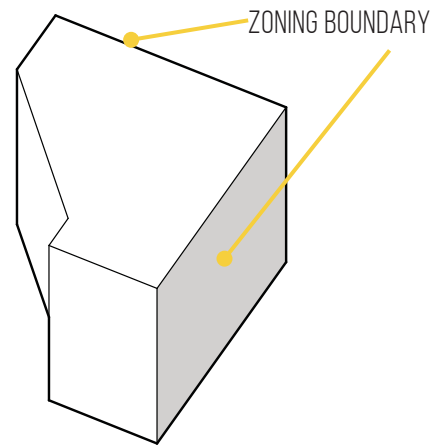

OPTION 2: BAR TO STREET

B1

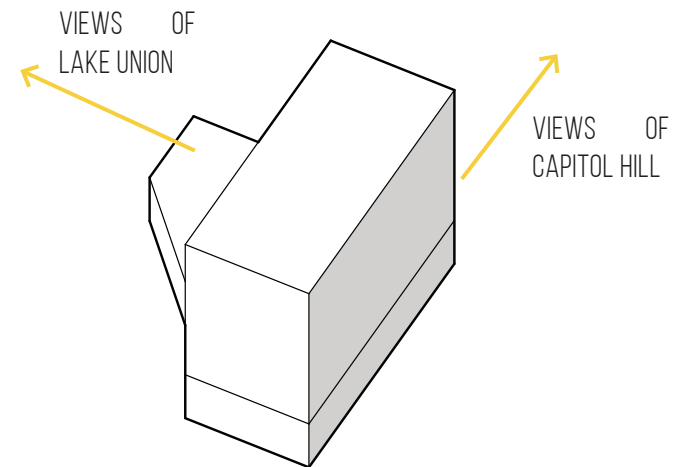

OPTION 3: BAR TO ALLEY - PREFERRED

A3

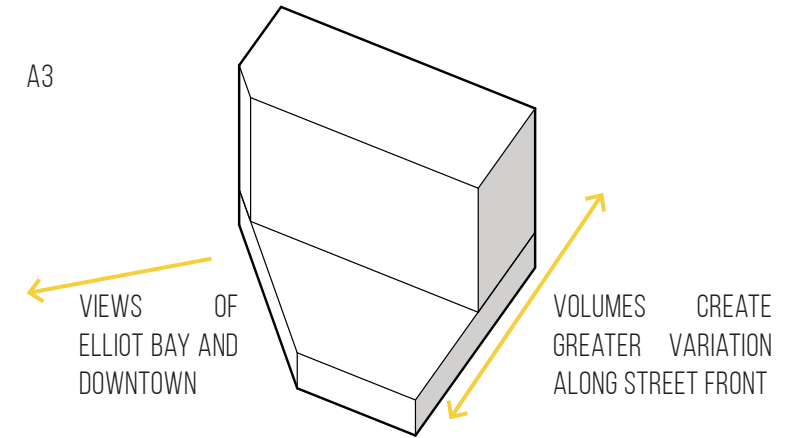

A2

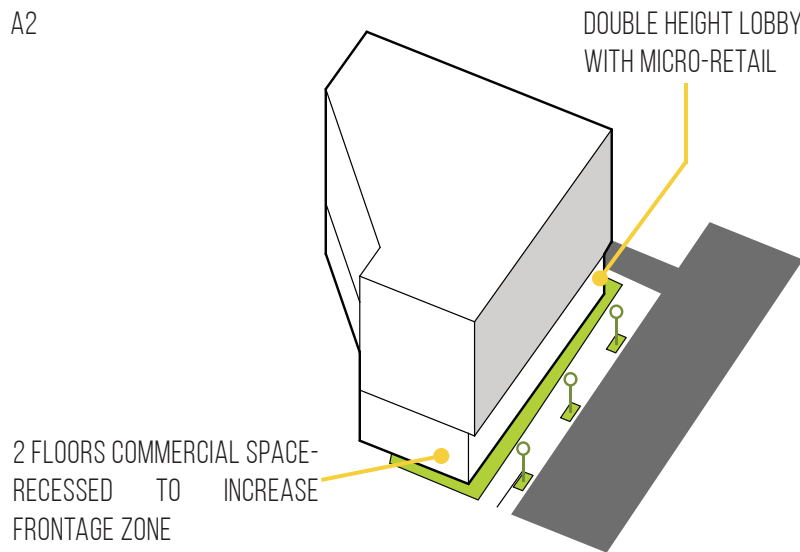

B2

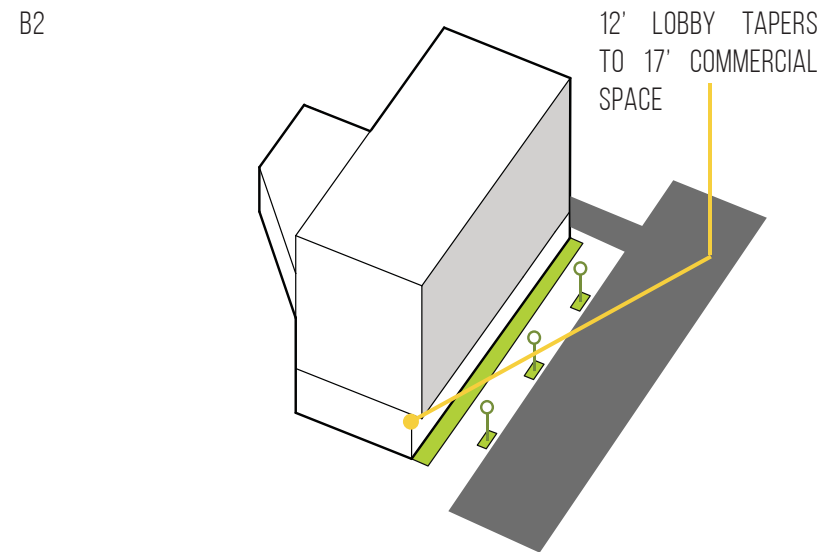

C2

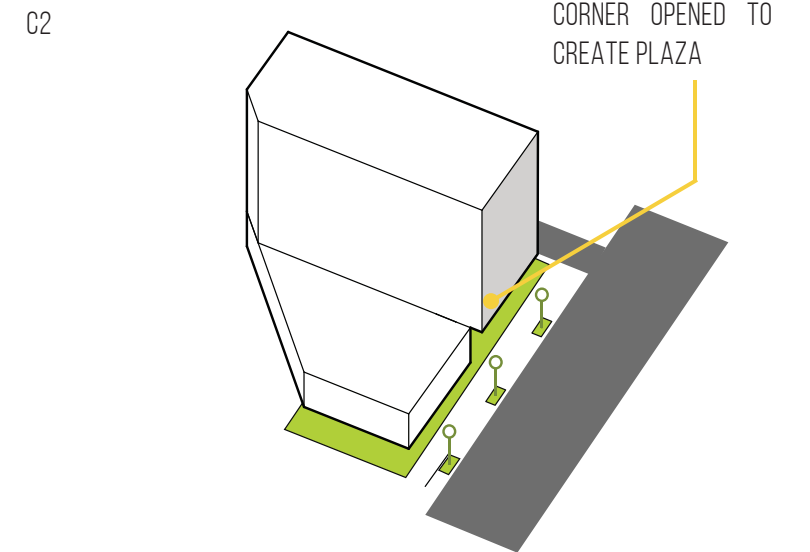

A3

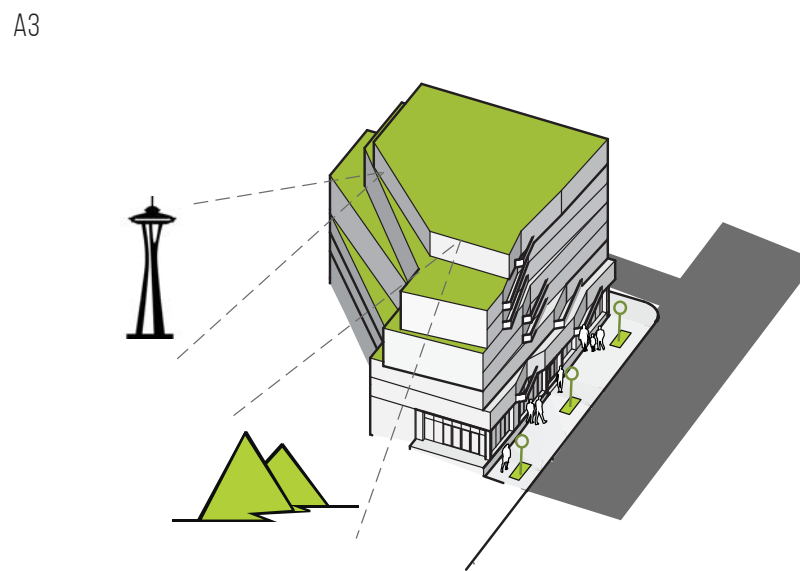

B3

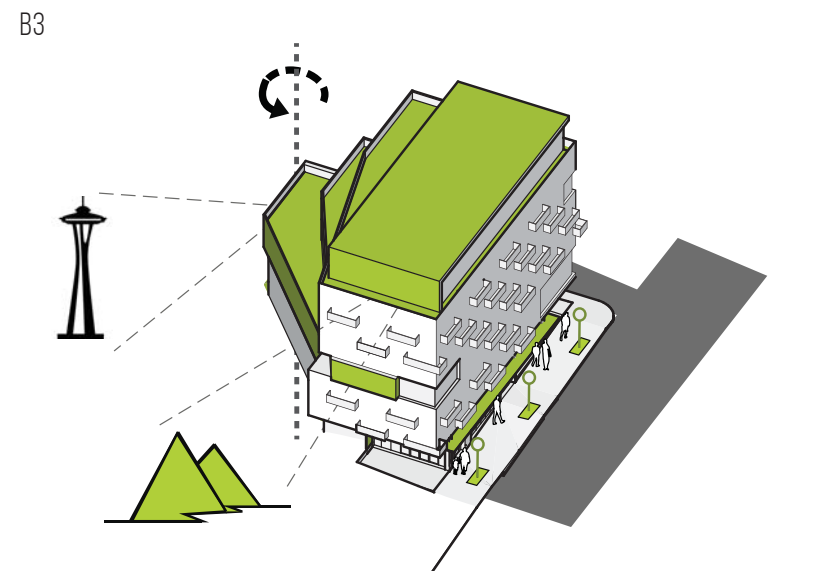

C3

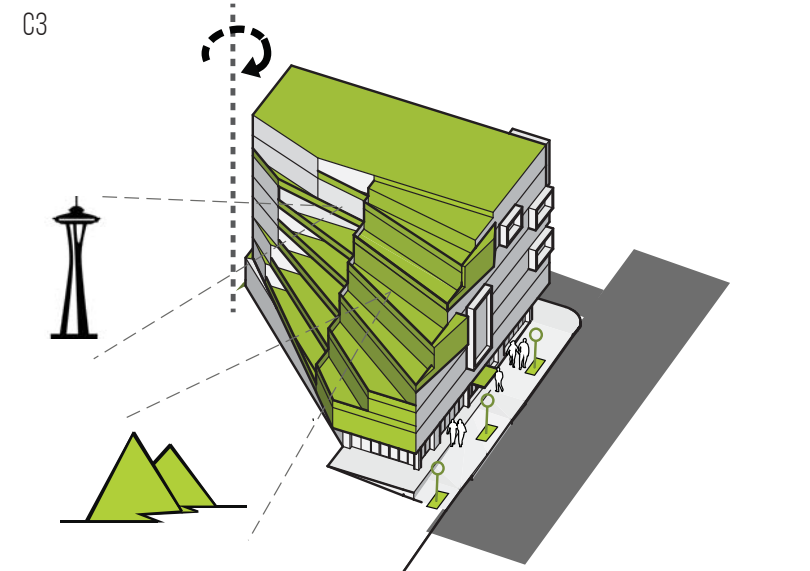



THE 'L'

- PROS -
- Max use of potential double height commercial space
 - Micro retail potential
 - More defined building edge
 - Both residential and commercial entries on primary pedestrian walkway

- CONS -
- Narrow units, less light
 - Less articulation of mass along street edge
 - Fewer opportunities for residential and pedestrian interaction
 - Fewer units have access to views of the sound



BAR TO STREET

- PROS -
- Articulation along alley breaks down mass of building when seen from other parts of capitol hill
 - Large shared decks with killer views provide means of social interaction among residents
 - More respectful of scs building, steps along east face to allow greater light into offices next door
 - Terracing creates interest along I-5

- CONS -
- Narrow units, less light
 - Break down of mass along alley and less prominent from street edge
 - More monolithic, less playful facade
 - Dramatic terracing not experienced along street front



BAR TO ALLEY -PREFERRED

- PROS -
- Private decks along the west face create spaces for quiet reflection, while terracing allows for community interaction between residents of different floors
 - Terraces along street front activate street and provide opportunities for interaction.
 - Shared entry space crates maximum interaction between residents and pedestrians
 - Microretail and gathering space creates node for community interaction, and activates street front
 - Concept is respectful of natural topography of capitol hill, and allows building to rise gracefully from the hill while
 - Terraces orientated to sunrise azimuth to allow summer sunset views.

- CONS -
- Limits roof deck area
 - Fewer units at higher levels with views

5. Massing Options



OPTION 1: THE BOX

PROS

- Articulated building entry located on 9th Avenue to allow human activity to spill out onto the most sun lit sidewalk adjacent to the property.
- Street level retail use is oriented at the building corner to activate and enliven the public street front.
- Lowest building height of all schemes

CONS

- Imposing mass oriented on 9th Avenue does not relate to the pedestrian scale.
- Minimal articulation between the podium and tower results in a bulky massing.
- Natural day-lighting and ventilation strategies will be limited due to deeper floor-plates above the podium



OPTION 2: THE "L"

PROS

- Articulated building entry located on 9th Avenue to allow human activity to spill out onto the most sun lit sidewalk adjacent to the property.
- Street level retail use is oriented at the building corner to activate and enliven the public street front.
- Narrow floor-plates increase potential for natural daylight and ventilation.
- L-shape configuration creates potential for multi-tenanted floors.
- The configuration allows for the dedication of considerable green space on the podium roof, both for occupant use and on-site storm-water management.

CONS

- The east west orientation of the 'L' mass limits solar penetration to the north.
- The building mass does not offer the most favorable transition to low-rise buildings to the north (along Thomas Street), impacting both perception of scale and solar access.
- The configuration results in an inefficient interior layout and loss of usable space due to required circulation.
- South facing glazing would be maximized, as would north. This might result in the need to create multiple environmental zones within the building and introduce challenges to natural ventilation.

5. Massing Options



OPTION 3: THE BAR **PREFERRED** (OFFICE ALTERNATIVE)

OPTION 3: THE BAR **PREFERRED** (HOTEL ALTERNATIVE)

PROS

- Articulated building entry located on 9th Avenue to allow human activity to spill out onto the most sun lit sidewalk adjacent to the property.
- Street level retail use is oriented at the building corner to activate and enliven the public street front.
- The narrow floor-plate provides the best opportunity of-all options to maximize day-lighting and natural ventilation, and improve the building's overall energy performance.
- The orientation provides an efficient floor-plate for single floor tenants and also creates the opportunity for multi-tenanting on single floors.
- The configuration results in a slender, tall tower that minimizes impact on the street, and reduces the overall sense of bulk and mass of the project.
- The podium can be articulated as a distinct form, at a transitional scale between the smaller and larger projects in the area.

CONS

- The scale of building articulation is less than the L-shaped scheme, although the opportunity exists for stronger articulation at the podium level (glazed pavilion).

PREFERRED APPROACH

The project is inspired by the lessons learned in the warehouse, in keeping with the nature of the industrial South Lake Union neighborhood—a building that provides graceful functionality, flexibility, and acts as a platform for the businesses, residences and shops that will inhabit it over time. It will be these uses that activate the neighborhood and make the project a true place and neighborhood anchor.

Like a warehouse, the building is an open framework for activity, expressive of its structural and material elements, while adapting easily to changing uses and users. Materials will be chosen based on their performance as well as their ability to age gracefully over time, and will anticipate the fact that some elements may be renovated and re-imagined over the longer life of the structure. Indoor and outdoor relationships will be varied through the use of transitional spaces such as a planted courtyard, indoor/outdoor rooms, terraces and roof gardens.

The base of the building creates a highly permeable pedestrian scaled environment, with numerous activating elements including retail storefronts, as well as public gathering spaces, and transitional spaces between indoors and outdoors, the public and private realms. An elevated podium roof garden and terrace provides another transition between the neighborhood and the workplaces within the project, while offering a vantage point to the neighborhood and nearby focal landmarks like Denny Park, Lake Union and the Seattle Center.

The upper floors of the building will be articulated to maximize views, and light and air for users. In doing so, the building's orientation and configuration also anticipates future development and maintains distances and setbacks to allow similar benefits to other properties. The configuration of the various slender tower form options not only benefits users by providing the most optimal spaces, but results in reduced bulk and mass impacts on the surrounding neighborhood.



FORMAL DEVELOPMENT FOR ALTERNATIVE SCHEMES

SITE INVENTORY

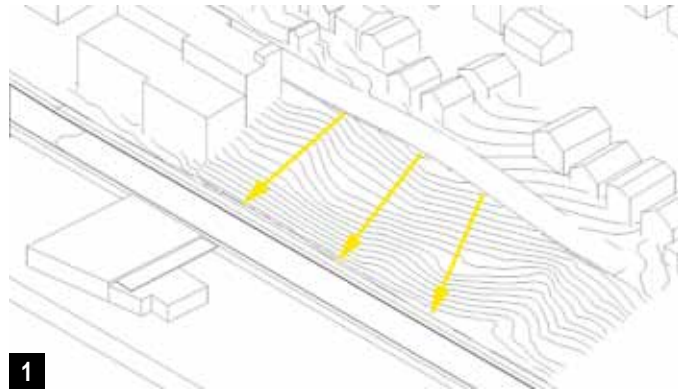

1
Sloped Topography

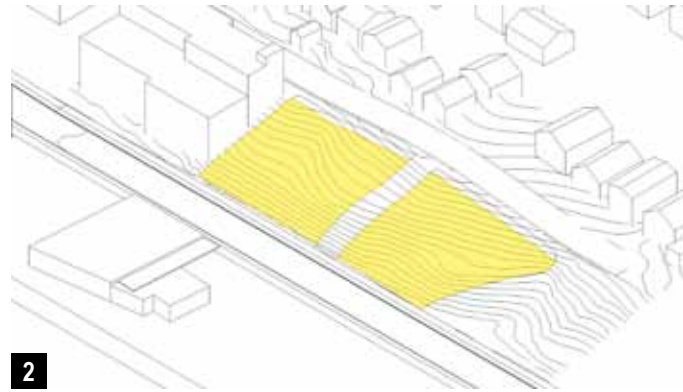

2
Two separate properties

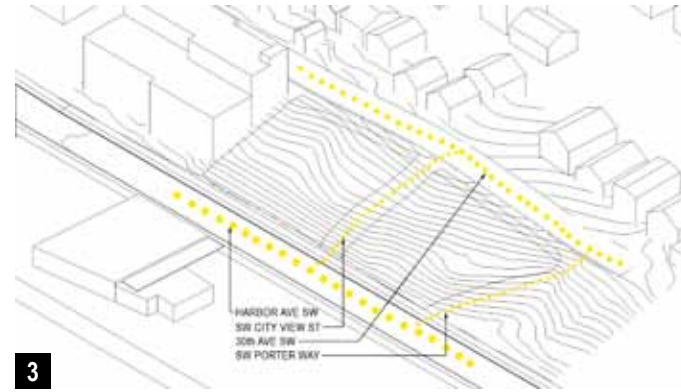

3
Adjacent right-of-ways

ALTERNATIVE 01 DEVELOPMENT

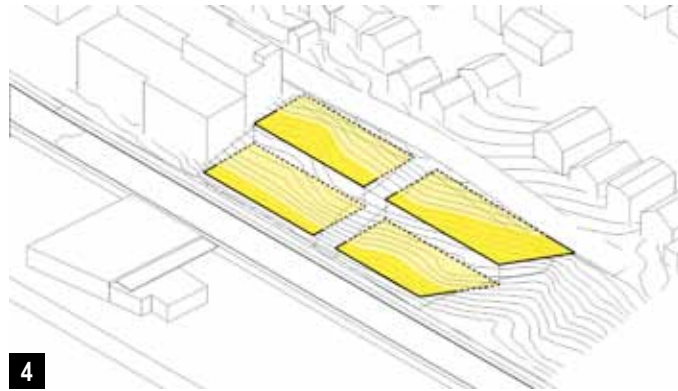

4
Height limit determined by separate sections due to topography

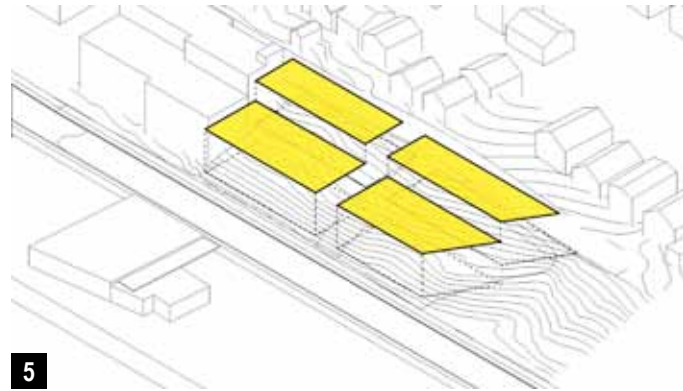

5
40'-0" height limit

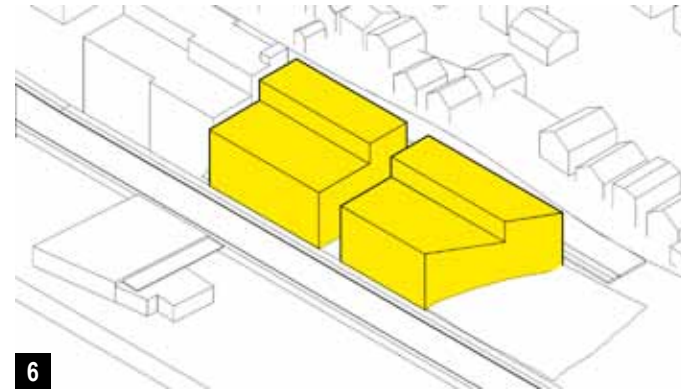

6
Allowable building volume per zoning regulations

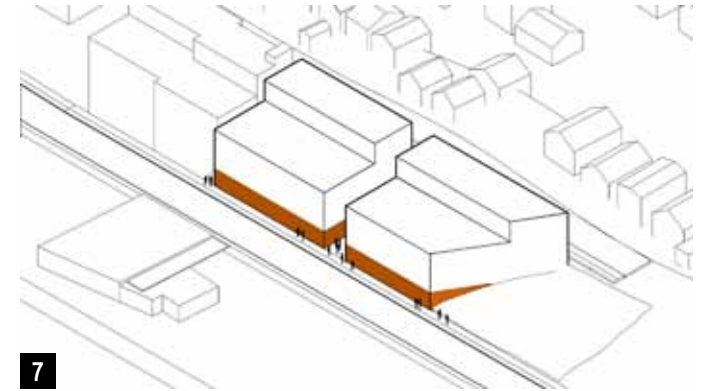

7
Establish Live/Work and Parking Garage as building base

ALTERNATIVE 02 DEVELOPMENT

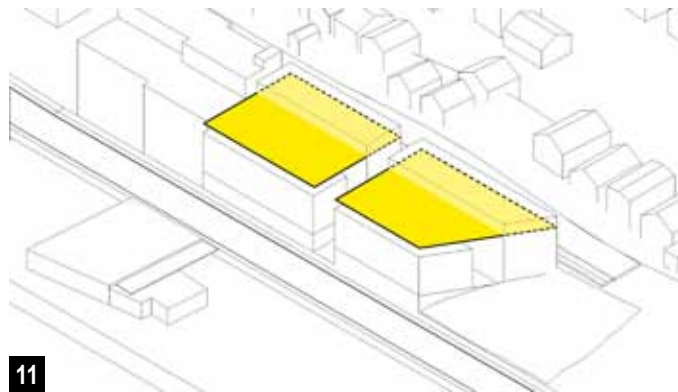

11
Height limit determined by average grade of entire site



12
Consolidate building volumes with lower height along 30th Ave SW

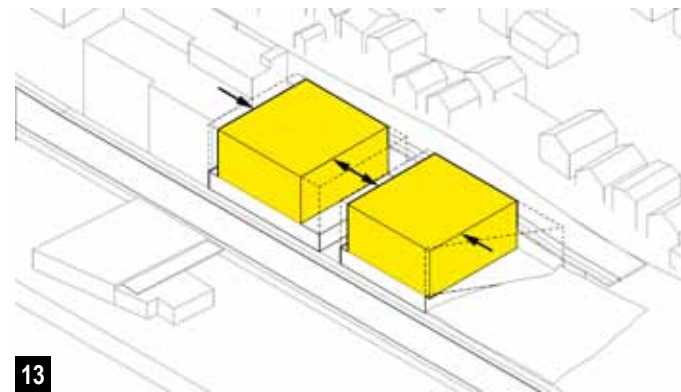

13
Provide generous open space between buildings



14
Insert residential and public courtyards between volumes

ALTERNATIVE 03 DEVELOPMENT

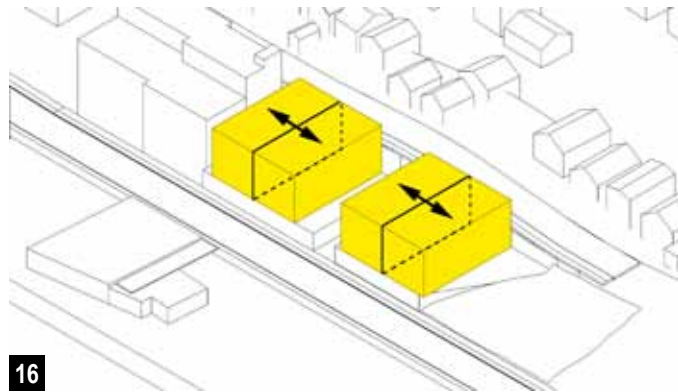

16
Divide building volumes



17
Create granularity more consistent with SFR across 30th Ave SW

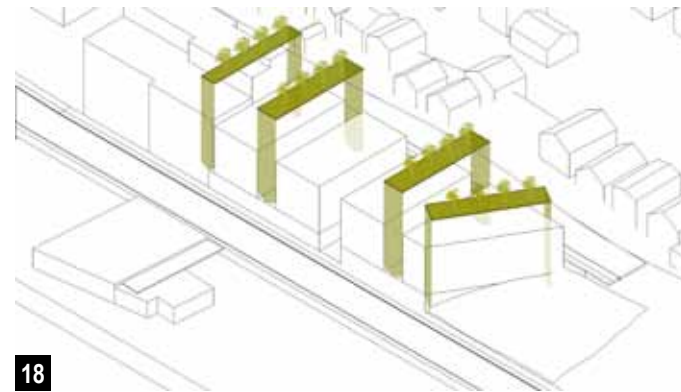

18
Insert residential and public courtyards between volumes

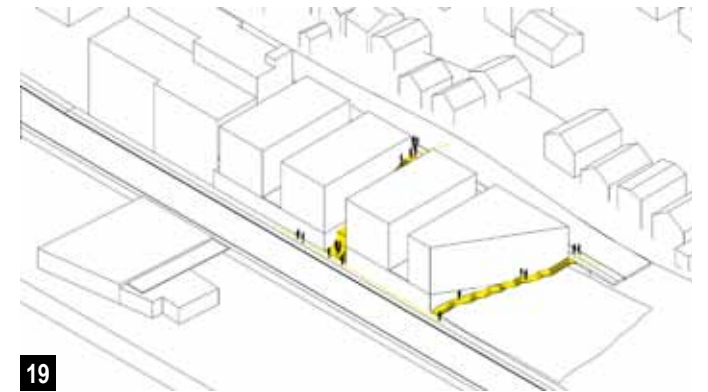

19
Connect Harbor Ave SW and 30th Ave SW with stair in public ROW

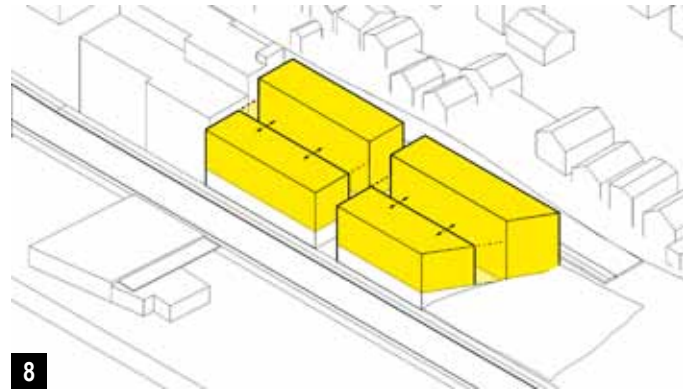

8
Separate volume to create units with light and air from two sides

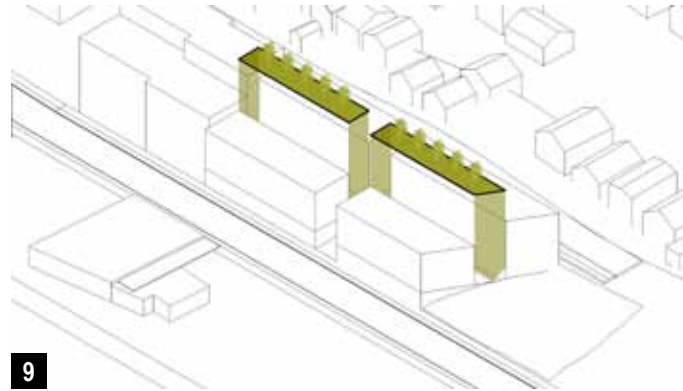

9
Insert residential courtyard between building volumes

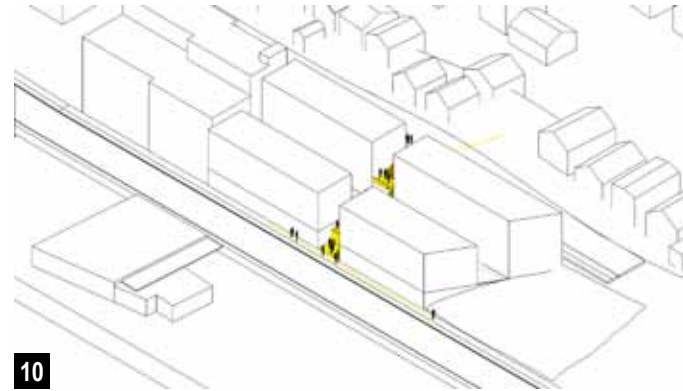

10
Connect Harbor Ave SW and 30th Ave SW with stair in public ROW

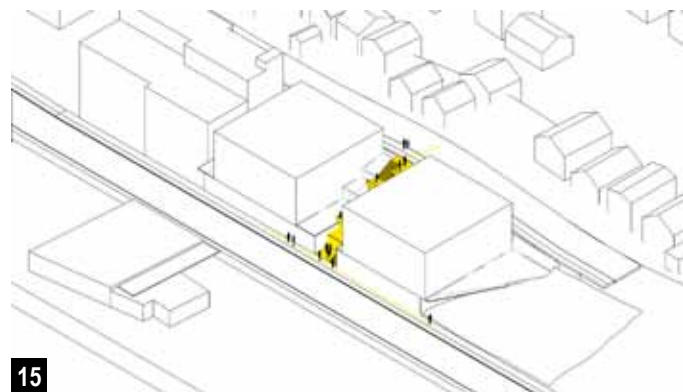

15
Connect Harbor Ave SW and 30th Ave SW with stair in public ROW

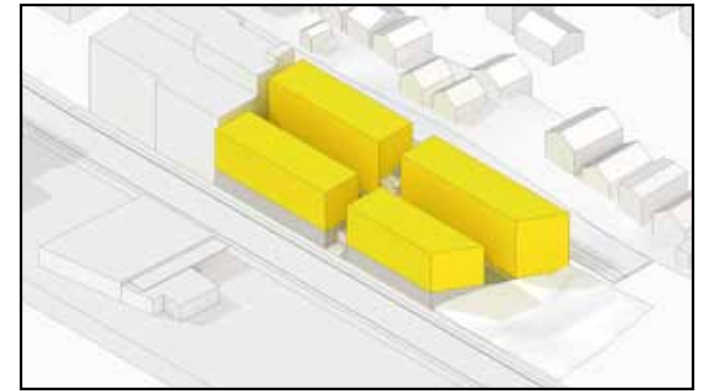

ALTERNATIVE 01 - SEE PAGES 24-25



ALTERNATIVE 02 - SEE PAGES 26-27

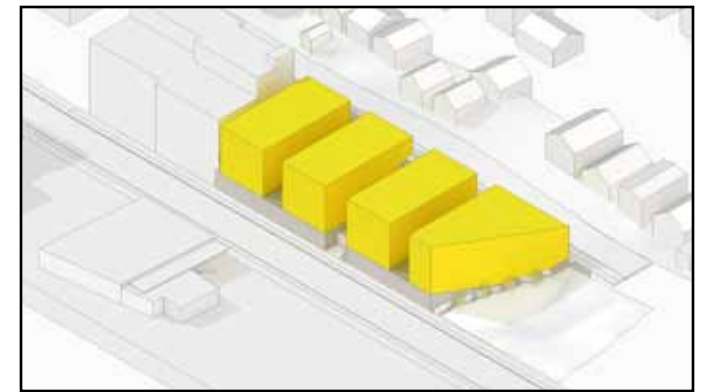

ALTERNATIVE 03 - SEE PAGES 28-29